

# Data Processing System Dictionary

**Mission Operations Directorate  
Operations Division**

**Generic, Rev K  
June 14, 2004**

**NOTE**

For use with OI-30 and Subs. Retain  
Rev J, 11 for use with OI-29

National Aeronautics and  
Space Administration

**Lyndon B. Johnson Space Center**  
Houston, Texas



***United Space Alliance***

**Verify this is the correct version for the pending operation (training, simulation or flight).**  
Electronic copies of FDF books are available. URL: <http://mod.jsc.nasa.gov/do3/FDF/index.html>



DPS DICTIONARY

GENERIC, Rev K (June 14, 2004)

## PCN-8 (Oct 8, 2008) Sheet 1 of 1

List of Implemented Change Requests (482s):

DPS-468  
DPS-469

Incorporate the following:

1. Replace iii thru x
2. Replace 1-5 & 1-6, 1-11 & 1-12
3. Remove A3-29 thru A3-32, B3-29 thru B3-32  
Add 3-29 thru 3-32
4. Replace 5-1 & 5-2, 5-37 & 5-38

**NOTE**For STS-126 and subsequent flights  
using OI-32 and OI-33 software

Prepared by:

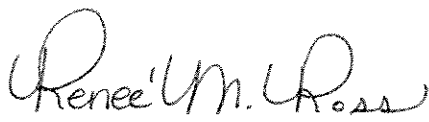

Publication Manager

Approved by:



Manager, Shuttle Procedures Management

Accepted by:



FDP Manager

Encl: 20 pages

**File this PCN immediately behind the front cover as a permanent record**



DPS DICTIONARY

GENERIC, Rev K (June 14, 2004)

## PCN-7 (Mar 26, 2008) Sheet 1 of 1

List of Implemented Change Requests (482s):

DPS-467A

Incorporate the following:

1. Replace iii thru vi
2. Replace 3-49 & 3-50, 3-57 & 3-58
3. Replace 5-19 thru 5-22

**NOTE**For STS-124 and subsequent flights  
using OI-30 and OI-32 software

Prepared by:

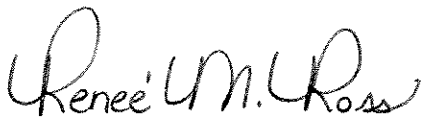

Publication Manager

Approved by:



Manager, Shuttle Procedures Management

Accepted by:



FDF Manager

Encl: 12 pages

**File this PCN immediately behind the front cover as a permanent record**



<b>DPS DICTIONARY</b>	<b>GENERIC, Rev K (June 14, 2004)</b>
-----------------------	---------------------------------------

**PCN-6 (Nov 5, 2007) Sheet 1 of 1**

List of Implemented Change Requests (482s):

- DPS-464
- DPS-465
- DPS-466

**NOTE**  
For STS-122 and subsequent flights  
using OI-30 and OI-32 software

Incorporate the following:

1. Replace iii thru vi
2. Replace 4-9 thru 4-12

**Prepared by:** Renee M. Ross  
Publication Manager

**Approved by:** Tanya Vaughan for  
Manager, Shuttle Procedures Management

**Accepted by:** Michael C. Shaw  
FDF Manager

Encl: 8 pages

**File this PCN immediately behind the front cover as a permanent record**





DPS DICTIONARY

GENERIC, Rev K (June 14, 2004)

## PCN-5 (July 16, 2007) Sheet 1 of 1

List of Implemented Change Requests (482s):

DPS-460A  
DPS-461  
DPS-462  
DPS-463

**NOTE**

For STS-118 and subsequent flights  
using OI-30 and OI-32 software

Incorporate the following:

1. Replace iii thru x
2. Replace 3-29 thru 3-32 with  
A3-29 thru B3-32 (8 pages)
3. Replace 5-1 & 5-2  
Replace 5-33 & 5-34  
Replace 5-37 & 5-38

Prepared by:

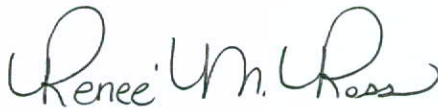

Publication Manager

Approved by:

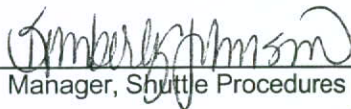

Manager, Shuttle Procedures Management

Accepted by:

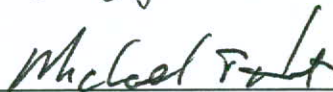

FDF Manager

Encl: 22 pages

File this PCN immediately behind the front cover as a permanent record



DPS DICTIONARY

GENERIC, Rev K (June 14, 2004)

## PCN-4 (Nov 14, 2006) Sheet 1 of 1

List of Implemented Change Requests (482s):

DPS-459A

Incorporate the following:

1. Replace iii thru x
2. Replace 4-1 & 4-2  
Replace 4-47 thru 4-50  
Replace 4-53 thru 4-56

**NOTE**

For STS-116 and subsequent flights

Prepared by:

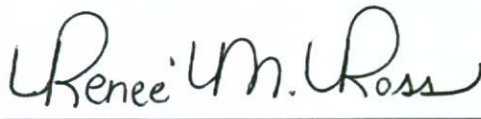

Publication Manager

Approved by:



Manager, Shuttle Procedures Management

Accepted by:

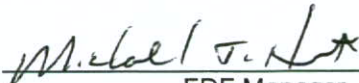

FDF Manager

Encl: 18 pages

**File this PCN immediately behind the front cover as a permanent record**



DPS DICTIONARY

GENERIC, Rev K (June 14, 2004)

## PCN-3 (May 11, 2006) Sheet 1 of 1

List of Implemented Change Requests (482s):

DPS-457

DPS-458

Incorporate the following:

1. Replace iii thru vi
2. Replace 4-29 & 4-30  
Replace 4-47 thru 4-50

**NOTE**

For STS-121 and subsequent flights

Prepared by:



Book Manager

Approved by:



Manager, Shuttle Procedures Management

Accepted by:



FDF Manager

Encl: 10 pages

**File this PCN immediately behind the front cover as a permanent record**



DPS DICTIONARY

GENERIC, Rev K (June 14, 2004)

## PCN-2 (Nov 18, 2005) Sheet 1 of 1

List of Implemented Change Requests (482s):

DPS-455  
DPS-456

Incorporate the following:

1. Replace iii thru vi
2. Replace 4-1 & 4-2
3. Replace 6-3 & 6-4

**NOTE**

For STS-121 and subsequent flights

Prepared by:

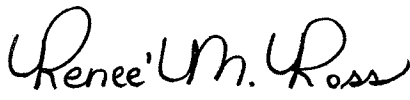

Book Manager

Approved by:



Manager, Shuttle Procedures Management

Accepted by:



PDF Manager

Encl: 8 pages

**File this PCN immediately behind the front cover as a permanent record**





DPS DICTIONARY

GENERIC, Rev K (June 14, 2004)

## PCN-1 (Apr 29, 2005) Sheet 1 of 1

List of Implemented Change Requests (482s):

DPS-447A	DPS-451	MULTI-1699
DPS-448	DPS-452	
DPS-449	DPS-453	
DPS-450	DPS-454	

Incorporate the following:

1. Replace iii thru xii
2. Replace 1-3 & 1-4
3. Replace 2-1 & 2-2, 2-9 & 2-10, 2-13 & 2-14
4. Replace 3-3 thru 3-12, 3-21 & 3-22, 3-31 & 3-32, 3-35 thru 3-38, 3-45 & 3-46, 3-51 & 3-52, 3-79 & 3-80
5. Replace 4-5 & 4-6  
After 4-6, add 4-6a & 4-6b  
Replace 4-7 & 4-8, 4-13 & 4-14, 4-17 thru 4-20, 4-23 & 4-24, 4-27 & 4-28, 4-31 & 4-32, 4-37 thru 4-40  
After 4-40, add 4-40a & 4-40b  
Replace 4-41 thru 4-54  
After 4-54, add 4-55 thru 4-58
6. Replace 5-19 thru 5-22, 5-33 thru 5-38
7. Replace 6-1 & 6-2

**NOTE**

For STS-114 and subsequent flights

Prepared by:



Book Manager

Approved by:



Manager, Shuttle Procedures Management

Accepted by:



FDF Manager

Encl: 96 pages

**File this PCN immediately behind the front cover as a permanent record**



MISSION OPERATIONS DIRECTORATE  
**DATA PROCESSING SYSTEM DICTIONARY**

GENERIC, REVISION K  
June 14, 2004

PREPARED BY:

---

Renee' M. Ross  
Book Manager

APPROVED BY:

---

Michael D. Feierstein  
Manager, Shuttle Procedures Management

---

Michael T. Hurt  
FDF Manager

This document is under the configuration control of the Crew Procedures Control Board (CPCB). All proposed changes must be submitted via FDF Workflow.

Distribution of this book is electronic format only. Requests for limited numbers of hard copies may be submitted via email to DO3/Book Manager and must include justification.

Incorporates the following:	
482#:	DPS-440A DPS-441 DPS-442 DPS-443 DPS-444B DPS-445 DPS-446
	MULTI-1661

AREAS OF TECHNICAL RESPONSIBILITY

Book Manager	DO3/R. Ross	281-244-1104
Alternate Book Manager	DO3/J. Woodard	281-483-9685

DATA PROCESSING SYSTEM DICTIONARY

**LIST OF EFFECTIVE PAGES**

GENERIC 04/15/88

REV K 06/14/04  
 PCN-1 04/29/05  
 PCN-2 11/18/05  
 PCN-3 05/11/06  
 PCN-4 11/14/06  
 PCN-5 07/16/07  
 PCN-6 11/05/07  
 PCN-7 03/26/08  
 PCN-8 10/08/08

Sign Off .....	*	ALL/GEN K	2-17 .....	ALL/GEN K
ii.....	*	ALL/GEN K	2-18 .....	ALL/GEN K
iii.....	*	ALL/GEN K,8	2-19 .....	ALL/GEN K
iv.....	*	ALL/GEN K,8	2-20 .....	ALL/GEN K
v .....	*	ALL/GEN K,8	3-1 .....	ALL/GEN K
vi.....	*	ALL/GEN K	3-2 .....	ALL/GEN K
vii.....		ALL/GEN K	3-3 .....	ALL/GEN K
viii.....		ALL/GEN K,4	3-4 .....	ALL/GEN K,1
ix.....		ALL/GEN K,8	3-5 .....	ALL/GEN K
x .....		ALL/GEN K	3-6 .....	ALL/GEN K,1
xi.....		ALL/GEN K,1	3-7 .....	ALL/GEN K,1
xii.....		ALL/GEN K	3-8 .....	ALL/GEN K
1-1 .....		ALL/GEN K	3-9 .....	ALL/GEN K
1-2.....		ALL/GEN K	3-10 .....	ALL/GEN K,1
1-3.....		ALL/GEN K,1	3-11 .....	ALL/GEN K,1
1-4.....		ALL/GEN K	3-12 .....	ALL/GEN K
1-5.....		ALL/GEN K	3-13 .....	ALL/GEN K
1-6.....		ALL/GEN K,8	3-14 .....	ALL/GEN K
1-7.....		ALL/GEN K	3-15 .....	ALL/GEN K
1-8.....		ALL/GEN K	3-16 .....	ALL/GEN K
1-9.....		ALL/GEN K	3-17 .....	ALL/GEN K
1-10.....		ALL/GEN K	3-18 .....	ALL/GEN K
1-11.....		ALL/GEN K,8	3-19 .....	ALL/GEN K
1-12.....		ALL/GEN K	3-20 .....	ALL/GEN K
2-1 .....		ALL/GEN K	3-21 .....	ALL/GEN K
2-2.....		ALL/GEN K,1	3-22 .....	ALL/GEN K,1
2-3.....		ALL/GEN K	3-23 .....	ALL/GEN K
2-4.....		ALL/GEN K	3-24 .....	ALL/GEN K
2-5.....		ALL/GEN K	3-25 .....	ALL/GEN K
2-6.....		ALL/GEN K	3-26 .....	ALL/GEN K
2-7.....		ALL/GEN K	3-27 .....	ALL/GEN K
2-8.....		ALL/GEN K	3-28 .....	ALL/GEN K
2-9.....		ALL/GEN K	A3-29.....	deleted
2-10.....		ALL/GEN K,1	A3-30.....	deleted
2-11.....		ALL/GEN K	A3-31.....	deleted
2-12.....		ALL/GEN K	A3-32.....	deleted
2-13.....		ALL/GEN K	B3-29.....	deleted
2-14.....		ALL/GEN K,1	B3-30.....	deleted
2-15.....		ALL/GEN K	B3-31.....	deleted
2-16.....		ALL/GEN K	B3-32.....	deleted

\* – Omit from flight book

3-29	ALL/GEN K,8	3-83	ALL/GEN K
3-30	ALL/GEN K,8	3-84	ALL/GEN K
3-31	ALL/GEN K,8	3-85	ALL/GEN K
3-32	ALL/GEN K,8	3-86	ALL/GEN K
3-33	ALL/GEN K	3-87	ALL/GEN K
3-34	ALL/GEN K	3-88	ALL/GEN K
3-35	ALL/GEN K,1	3-89	ALL/GEN K
3-36	ALL/GEN K	3-90	ALL/GEN K
3-37	ALL/GEN K,1	3-91	ALL/GEN K
3-38	ALL/GEN K	3-92	ALL/GEN K
3-39	ALL/GEN K	3-93	ALL/GEN K
3-40	ALL/GEN K	3-94	ALL/GEN K
3-41	ALL/GEN K	3-95	ALL/GEN K
3-42	ALL/GEN K	3-96	ALL/GEN K
3-43	ALL/GEN K	3-97	ALL/GEN K
3-44	ALL/GEN K	3-98	ALL/GEN K
3-45	ALL/GEN K	3-99	ALL/GEN K
3-46	ALL/GEN K,1	3-100	ALL/GEN K
3-47	ALL/GEN K	3-101	ALL/GEN K
3-48	ALL/GEN K	3-102	ALL/GEN K
3-49	ALL/GEN K,7	3-103	ALL/GEN K
3-50	ALL/GEN K	3-104	ALL/GEN K
3-51	ALL/GEN K,1	3-105	ALL/GEN K
3-52	ALL/GEN K	3-106	ALL/GEN K
3-53	ALL/GEN K	4-1	ALL/GEN K,4
3-54	ALL/GEN K	4-2	ALL/GEN K
3-55	ALL/GEN K	4-3	ALL/GEN K
3-56	ALL/GEN K	4-4	ALL/GEN K
3-57	ALL/GEN K	4-5	ALL/GEN K,1
3-58	ALL/GEN K,7	4-6	ALL/GEN K,1
3-59	ALL/GEN K	4-6a	ALL/GEN K,1
3-60	ALL/GEN K	4-6b	ALL/GEN K,1
3-61	ALL/GEN K	4-7	ALL/GEN K,1
3-62	ALL/GEN K	4-8	ALL/GEN K
3-63	ALL/GEN K	4-9	ALL/GEN K,6
3-64	ALL/GEN K	4-10	ALL/GEN K,6
3-65	ALL/GEN K	4-11	ALL/GEN K,6
3-66	ALL/GEN K	4-12	ALL/GEN K
3-67	ALL/GEN K	4-13	ALL/GEN K
3-68	ALL/GEN K	4-14	ALL/GEN K,1
3-69	ALL/GEN K	4-15	ALL/GEN K
3-70	ALL/GEN K	4-16	ALL/GEN K
3-71	ALL/GEN K	4-17	ALL/GEN K,1
3-72	ALL/GEN K	4-18	ALL/GEN K,1
3-73	ALL/GEN K	4-19	ALL/GEN K,1
3-74	ALL/GEN K	4-20	ALL/GEN K
3-75	ALL/GEN K	4-21	ALL/GEN K
3-76	ALL/GEN K	4-22	ALL/GEN K
3-77	ALL/GEN K	4-23	ALL/GEN K
3-78	ALL/GEN K	4-24	ALL/GEN K,1
3-79	ALL/GEN K	4-25	ALL/GEN K
3-80	ALL/GEN K,1	4-26	ALL/GEN K
3-81	ALL/GEN K	4-27	ALL/GEN K
3-82	ALL/GEN K	4-28	ALL/GEN K,1

4-29	ALL/GEN K	5-23	ALL/GEN K
4-30	ALL/GEN K,3	5-24	ALL/GEN K
4-31	ALL/GEN K,1	5-25	ALL/GEN K
4-32	ALL/GEN K	5-26	ALL/GEN K
4-33	ALL/GEN K	5-27	ALL/GEN K
4-34	ALL/GEN K	5-28	ALL/GEN K
4-35	ALL/GEN K	5-29	ALL/GEN K
4-36	ALL/GEN K	5-30	ALL/GEN K
4-37	ALL/GEN K,1	5-31	ALL/GEN K
4-38	ALL/GEN K,1	5-32	ALL/GEN K
4-39	ALL/GEN K,1	5-33	ALL/GEN K
4-40	ALL/GEN K,1	5-34	ALL/GEN K,5
4-40a	ALL/GEN K,1	5-35	ALL/GEN K
4-40b	ALL/GEN K,1	5-36	ALL/GEN K
4-41	ALL/GEN K	5-37	ALL/GEN K
4-42	ALL/GEN K	5-38	ALL/GEN K,8
4-43	ALL/GEN K,1	6-1	ALL/GEN K,1
4-44	ALL/GEN K	6-2	ALL/GEN K,1
4-45	ALL/GEN K	6-3	ALL/GEN K,2
4-46	ALL/GEN K,1	6-4	ALL/GEN K
4-47	ALL/GEN K	6-5	ALL/GEN K
4-48	ALL/GEN K,4	6-6	ALL/GEN K
4-49	ALL/GEN K,4	6-7	ALL/GEN K
4-50	ALL/GEN K,1	6-8	ALL/GEN K
4-51	ALL/GEN K,1	6-9	ALL/GEN K
4-52	ALL/GEN K,1	6-10	ALL/GEN K
4-53	ALL/GEN K,1	6-11	ALL/GEN K
4-54	ALL/GEN K,4	6-12	ALL/GEN K
4-55	ALL/GEN K,4	6-13	ALL/GEN K
4-56	ALL/GEN K,1	6-14	ALL/GEN K
4-57	ALL/GEN K,1	6-15	ALL/GEN K
4-58	ALL/GEN K,1	6-16	ALL/GEN K
5-1	ALL/GEN K,8	6-17	ALL/GEN K
5-2	ALL/GEN K	6-18	ALL/GEN K
5-3	ALL/GEN K	6-19	ALL/GEN K
5-4	ALL/GEN K	6-20	ALL/GEN K
5-5	ALL/GEN K	6-21	ALL/GEN K
5-6	ALL/GEN K	6-22	ALL/GEN K
5-7	ALL/GEN K	6-23	ALL/GEN K
5-8	ALL/GEN K	6-24	ALL/GEN K
5-9	ALL/GEN K	6-25	ALL/GEN K
5-10	ALL/GEN K	6-26	ALL/GEN K
5-11	ALL/GEN K	6-27	ALL/GEN K
5-12	ALL/GEN K	6-28	ALL/GEN K
5-13	ALL/GEN K	6-29	ALL/GEN K
5-14	ALL/GEN K	6-30	ALL/GEN K
5-15	ALL/GEN K	6-31	ALL/GEN K
5-16	ALL/GEN K	6-32	ALL/GEN K
5-17	ALL/GEN K		
5-18	ALL/GEN K		
5-19	ALL/GEN K,7		
5-20	ALL/GEN K,1		
5-21	ALL/GEN K,1		
5-22	ALL/GEN K,7		

This Page Intentionally Blank



CONTENTS

PAGE

OVERVIEW .....	1-1
GNC MAJOR MODE TRANSITIONS AND DISPLAY SUMMARY (PASS) .....	1-2
SM MAJOR MODE TRANSITIONS AND DISPLAY SUMMARY (PASS) .....	1-6
PL MAJOR MODE TRANSITIONS AND DISPLAY SUMMARY (PASS) .....	1-7
GNC MAJOR MODE TRANSITIONS AND DISPLAY SUMMARY (BFS) .....	1-8
SM DISPLAY SUMMARY (BFS) .....	1-11
SYSTEM SOFTWARE CRT DISPLAYS .....	2-1
OPS 0001 GPC MEMORY .....	2-2
SPEC 1 DPS UTILITY .....	2-6
*SPEC 2 TIME .....	2-9
DISP 6 GPC/BUS STATUS .....	2-12
DISP 99 FAULT .....	2-13
DEU STAND-ALONE SELF-TEST .....	2-14
XXXXIPL MENU .....	2-16
OPERATIONAL TEST PROGRAM .....	2-18
*NOT AVAILABLE IN OPS G1, OPS G3, OR OPS G6	
GNC CRT DISPLAYS .....	3-1
<u>OPS G1 (ASCENT)</u> .....	3-3
OPS 1011 XXXXXX TRAJ .....	3-4
OPS 1041 XXXXX MNVR YYYY .....	3-7
DISP 18 GNC SYS SUMM 1 .....	(SEE GNC, OPS G2, PAGE 3-22)
SPEC 23 RCS .....	(SEE GNC, OPS G2, PAGE 3-35)
SPEC 50 HORIZ SIT .....	(SEE GNC, OPS G3, PAGE 3-68)
SPEC 51 OVERRIDE .....	3-12
SPEC 53 CONTROLS .....	(SEE GNC, OPS G3, PAGE 3-75)
<u>OPS G2 (ORBIT)</u> .....	3-17
OPS 2011 UNIV PTG .....	3-18
OPS 2021 XXXXX MNVR YYYY .....	(SEE GNC, OPS G1, PAGE 3-7)
DISP 18 GNC SYS SUMM 1 .....	3-22
DISP 19 GNC SYS SUMM 2 .....	3-24
SPEC 20 DAP CONFIG .....	3-26
SPEC 21 IMU ALIGN .....	3-30
SPEC 22 S TRK/COAS CNTL .....	3-33
SPEC 23 RCS .....	3-35
SPEC 25 RM ORBIT .....	3-39
SPEC 33 REL NAV .....	3-41
SPEC 34 ORBIT TGT .....	3-46
SPEC 55 GPS STATUS .....	3-49
<u>OPS G3 (ENTRY)</u> .....	3-59
OPS 3011 XXXXX MNVR YYYY .....	(SEE GNC, OPS G1, PAGE 3-7)
OPS 3041 ENTRY TRAJ 1 .....	3-60
OPS 3041           2 .....	3-62
OPS 3041           3 .....	3-62
OPS 3041           4 .....	3-63
OPS 3041           5 .....	3-63
OPS 3051 VERT SIT 1 .....	3-64
OPS 3051           2 .....	3-67
DISP 18 GNC SYS SUMM 1 .....	(SEE GNC, OPS G2, PAGE 3-22)
SPEC 21 IMU ALIGN .....	(SEE GNC, OPS G2, PAGE 3-30)
SPEC 22 S TRK/COAS CNTL .....	(SEE GNC, OPS G2, PAGE 3-33)
SPEC 23 RCS .....	(SEE GNC, OPS G2, PAGE 3-35)
SPEC 50 HORIZ SIT .....	3-68
SPEC 51 OVERRIDE .....	(SEE GNC, OPS G1, PAGE 3-12)
SPEC 53 CONTROLS .....	3-75
SPEC 55 GPS STATUS .....	(SEE GNC, OPS G2, PAGE 3-49)

<u>OPS G6 (ABORTS)</u> .....	3-77
OPS 6011 XXXXXX TRAJ .....	(SEE GNC, OPS G1, PAGE 3-4)
OPS 6021 VERT SIT 1 .....	(SEE GNC, OPS G3, PAGE 3-64)
OPS 6031 VERT SIT 2.....	(SEE GNC, OPS G3, PAGE 3-67)
DISP 18 GNC SYS SUMM 1.....	(SEE GNC, OPS G2, PAGE 3-22)
SPEC 23 RCS .....	(SEE GNC, OPS G2, PAGE 3-35)
SPEC 50 HORIZ SIT .....	(SEE GNC, OPS G3, PAGE 3-68)
SPEC 51 OVERRIDE .....	(SEE GNC, OPS G1, PAGE 3-12)
SPEC 53 CONTROLS.....	(SEE GNC, OPS G3, PAGE 3-75)

<u>OPS G8 (ON-ORBIT VEHICLE UTILITY)</u> .....	3-79
OPS 8011 FCS/DED DIS C/O.....	3-80
DISP 18 GNC SYS SUMM 1.....	(SEE GNC, OPS G2, PAGE 3-22)
DISP 19 GNC SYS SUMM 2.....	(SEE GNC, OPS G2, PAGE 3-24)
SPEC 23 RCS .....	(SEE GNC, OPS G2, PAGE 3-35)
SPEC 40 SENSOR TEST .....	3-82
SPEC 41 RGA/ADTA/RCS.....	3-83
SPEC 42 SWITCH/SURF .....	3-84
SPEC 43 CONTROLLERS.....	3-86
SPEC 44 SWITCHES.....	3-88
SPEC 45 NWS CHECK.....	3-89
SPEC 55 GPS STATUS.....	(SEE GNC, OPS G2, PAGE 3-49)

<u>OPS G9 (PREFLIGHT VEHICLE UTILITY)</u> .....	3-91
OPS 9011 GPC MEMORY .....	(SEE SYS S/W, PAGE 2-2)
SPEC 55 GPS STATUS.....	(SEE GNC, OPS G2, PAGE 3-49)
SPEC 100 GTS DISPLAY .....	3-92
SPEC 101 SENSOR SELF-TEST .....	3-94
SPEC 102 RCS/RGA/ADTA TEST .....	3-95
SPEC 104 GND IMU CNTL/MON .....	3-97
SPEC 105 TCS CONTROL.....	3-99
DISP 106 MANUAL CONTROLS.....	3-101
SPEC 112 GPC/BTU I/F.....	3-102
SPEC 113 ACTUATOR CONTROL .....	3-104

SYSTEMS MANAGEMENT CRT DISPLAYS..... 4-1

OPS 2011 ANTENNA.....	4-2
OPS 2021 PL BAY DOORS.....	4-5
SPEC 60 SM TABLE MAINT .....	4-7
SPEC 62 PCMMU/PL COMM .....	4-9
SPEC 64 SM GROUND CHECKOUT .....	4-12
DISP 66 ENVIRONMENT .....	4-14
DISP 67 ELECTRIC .....	4-16
DISP 68 CRYO SYSTEM.....	4-17
DISP 69 FUEL CELLS .....	4-18
DISP 76 COMMUNICATIONS .....	4-19
DISP 77 EVA-MMU/FSS.....	4-21
DISP 78 SM SYS SUMM 1 .....	4-22
DISP 79 SM SYS SUMM 2 .....	4-24
SPEC 85 MASS MEMORY R/W .....	4-26
DISP 86 APU/HYD.....	4-28
DISP 87 HYD THERMAL .....	4-30
DISP 88 APU/ENVIRON THERM .....	4-31
DISP 89 PRPLT THERMAL.....	4-33
SPEC 90 PCS CONTROL.....	4-34
SPEC 94 PDRS CONTROL .....	4-37
DISP 95 PDRS OVERRIDE .....	4-41
DISP 96 PDRS FAULTS.....	4-43
DISP 97 PL RETENTION.....	4-45
DISP 167 DOCKING STATUS.....	4-46
DISP 168 CARGO LOOP.....	4-48
DISP 169 PDRS STATUS.....	4-50
DISP 177 EXTERNAL AIRLOCK.....	4-52
DISP 179 POWER TRANSFER.....	4-54

<u>PAYLOAD (PL) CRT DISPLAYS</u> .....	4-55
SPEC 111 SL MEMORY DUMP.....	4-56
OPS 9011 MASS MEMORY R/W .....	(SEE SM, PAGE 4-26)
SPEC 100 GTS DISPLAY .....	(SEE GNC, OPS G9, PAGE 3-92)
<u>BACKUP FLIGHT SYSTEM (BFS) DISPLAYS</u> .....	5-1
<u>BFS SYSTEM SOFTWARE</u> .....	5-3
OPS 0001 BFS MEMORY.....	5-4
DISP 99 FAULT .....	(SEE SYS S/W, PAGE 2-13)
<u>BFS OPS G1 (ASCENT)</u> .....	5-7
OPS 1011 XXXXXX TRAJ 1.....	5-8
OPS 1031 XXXXXX TRAJ 2.....	5-9
OPS 1041 XXXXX MNVR YYYYY .....	(SEE GNC, OPS G1, PAGE 3-7)
DISP 18 GNC SYS SUMM 1.....	5-10
DISP 19 GNC SYS SUMM 2.....	(SEE GNC, OPS G2, PAGE 3-24)
SPEC 50 HORIZ SIT .....	5-12
SPEC 51 OVERRIDE .....	5-15
SPEC 55 GPS STATUS.....	5-19
<u>BFS OPS G3 (ENTRY)</u> .....	5-23
OPS 3011 XXXXX MNVR YYYYY .....	(SEE GNC, OPS G1, PAGE 3-7)
OPS 3041 ENTRY TRAJ 1.....	5-24
OPS 3041                   2.....	5-26
OPS 3041                   3.....	5-26
OPS 3041                   4.....	5-27
OPS 3041                   5.....	5-27
OPS 3051 VERT SIT 1 .....	(SEE GNC, OPS G3, PAGE 3-64)
OPS 3051                   2.....	(SEE GNC, OPS G3, PAGE 3-67)
DISP 18 GNC SYS SUMM 1.....	(SEE BFS, OPS G1, PAGE 5-10)
DISP 19 GNC SYS SUMM 2.....	(SEE GNC, OPS G2, PAGE 3-24)
SPEC 50 HORIZ SIT .....	(SEE BFS, OPS G1, PAGE 5-12)
SPEC 51 OVERRIDE .....	(SEE BFS, OPS G1, PAGE 5-15)
SPEC 55 GPS STATUS.....	(SEE BFS, OPS G1, PAGE 5-19)
<u>BFS OPS G6 (ABORTS)</u> .....	5-29
OPS 6011 RTLS TRAJ 2.....	5-30
OPS 6021 VERT SIT 1 .....	(SEE GNC, OPS G3, PAGE 3-64)
OPS 6031 VERT SIT 2.....	(SEE GNC, OPS G3, PAGE 3-67)
DISP 18 GNC SYS SUMM 1.....	(SEE BFS, OPS G1, PAGE 5-10)
DISP 19 GNC SYS SUMM 2.....	(SEE GNC, OPS G2, PAGE 3-24)
SPEC 50 HORIZ SIT .....	(SEE BFS, OPS G1, PAGE 5-12)
SPEC 51 OVERRIDE .....	(SEE BFS, OPS G1, PAGE 5-15)
SPEC 55 GPS STATUS.....	(SEE BFS, OPS G1, PAGE 5-19)
<u>BFS SM OPS 0</u> .....	5-31
OPS 0001 THERMAL.....	5-32
SPEC 63 PL BAY DOORS .....	(SEE SM, PAGE 4-5)
DISP 78 SM SYS SUMM 1 .....	5-34
DISP 79 SM SYS SUMM 2 .....	5-36
DISP 168 CARGO LOOP.....	5-38
<u>MULTIFUNCTION ELECTRONIC DISPLAY SYSTEM (MEDS) DISPLAYS</u> .....	6-1
MAIN MENU TREE.....	6-3
OMS/MPS DISPLAY .....	6-4
HYD/APU DISPLAY .....	6-5
SPI DISPLAY .....	6-7
A/E PRIMARY FLIGHT DISPLAY (A/E PFD) .....	6-8
PRELAUNCH A/E PFD.....	6-22
ORBIT PRIMARY FLIGHT DISPLAY (ORB PFD).....	6-24
SYSTEM STATUS DISPLAY WITH CST MENU.....	6-25
FILE PATCH ADDRESS DISPLAY .....	6-27
SYSTEM STATUS DISPLAY WITH IDP INTERACTIVE CST .....	6-28

FILE PATCH DISPLAY .....	6-29
PROG LOAD DISPLAY .....	6-30
FAULT SUMMARY DISPLAY .....	6-31

PROGRAM NOTES AND WAIVERS CROSS REFERENCE

<u>DR NO.</u>	<u>BFS NO.</u>	<u>DPS SECTION</u>	<u>SPEC/DISPLAY/TAB</u>	<u>DPS PAGE</u>
25372		SYS S/W	GPC MEMORY	2-4
29284		SYS S/W	TIME/SPEC 2	2-11
30526		GNC	SWITCH/SURF/SPEC 42	3-85
35151		GNC	S TRK/COAS CTL/SPEC 22	3-34
35572		GNC	FCS/DED DIS CO/8011	3-81
36015		GNC	XXX MNVR YYY/2021	3-8
36479		GNC	XXX MNVR YYY/2021	3-8
37123		GNC	XXX MNVR YYY/2021	3-11
37420		SYS S/W	DPS UTILITY/SPEC 1	2-6
37504		SYS S/W	TIME/SPEC 2	2-11
37506		SYS S/W	GPC MEMORY/0001	2-4
37516		SYS S/W	GPC MEMORY/0001	2-3
37561		GNC	XXX MNVR YYY/2021	3-11
37564		GNC	XXX MNVR YYY/2021	3-10
37572		SM	SM TABLE MAINT/SPEC 60	4-8
37573		GNC	XXX MNVR YYY/2021	3-10,3-11
37577		GNC	HORIZ SIT/SPEC 50	3-74
37584		SM	PCMMU/PL COMM/SPEC 62	4-10
37585		GNC	XXX MNVR YYY/2021	3-11
37591		GNC	XXX MNVR YYY/2021	3-10
37693		GNC	HORIZ SIT/SPEC 50	3-74
38163		GNC	XXX MNVR YYY/2021	3-7
39371		GNC	XXX MNVR YYY/2021	3-10
40620		SYS S/W	TIME/SPEC 2	2-11
41008		GNC	GPC/BTU IF/SPEC 112	3-103
42650		GNC	HORIZ SIT/SPEC 50	3-74
44250		GNC	FCS/DED DIS CO/8011	3-81
45703		GNC	HORIZ SIT/SPEC 50	3-74
45739		GNC	XXX MNVR YYY/2021	3-10a
45749		GNC	XXX MNVR YYY/1041,3011	3-11
46503		GNC	FCS/DED DIS CO/8011	3-81
46515	B07339	GNC	VERT SIT 1/3051	3-66
48348		GNC	XXX MNVR YYY/2021	3-11
53101		GNC	UNIV PTG/2011	3-20
55003		SM	PCMMU/PL COMM/SPEC 62	4-11
55217		GNC	OVERRIDE/SPEC 51	3-15
55302		SM	PCMMU/PL COMM/SPEC 62	4-11
55306		GNC	OVERRIDE/SPEC 51	3-15
55314		GNC	XXX MNVR YYY/2021	3-10
58374		GNC	UNIV PTG/2011	3-20
100520		GNC	IMU ALIGN/SPEC 21	3-32
101386		GNC	OVERRIDE/SPEC 51	3-15
104639		GNC	SYS SUMM 1/DISP 18	3-23
108559	B20611	GNC	XXX MNVR YYY/1041,3011	3-11
	B03926	SM	PL BAY DOORS/2021	4-6
	B08246	SM	PL BAY DOORS/2021	4-6
	B08297	BFS	BFS HORIZ SIT/SPEC 50	5-14
	B28716	SM	PL BAY DOORS/2021	4-6a

This Page Intentionally Blank

OVERVIEW

	<u>PAGE</u>
GNC MAJOR MODE TRANSITIONS AND DISPLAY SUMMARY (PASS).....	1-2
SM MAJOR MODE TRANSITIONS AND DISPLAY SUMMARY (PASS).....	1-6
PL MAJOR MODE TRANSITIONS AND DISPLAY SUMMARY (PASS).....	1-7
GNC MAJOR MODE TRANSITIONS AND DISPLAY SUMMARY (BFS).....	1-8
SM DISPLAY SUMMARY (BFS).....	1-11

GNC MAJOR MODE TRANSITIONS AND DISPLAY SUMMARY (PASS)

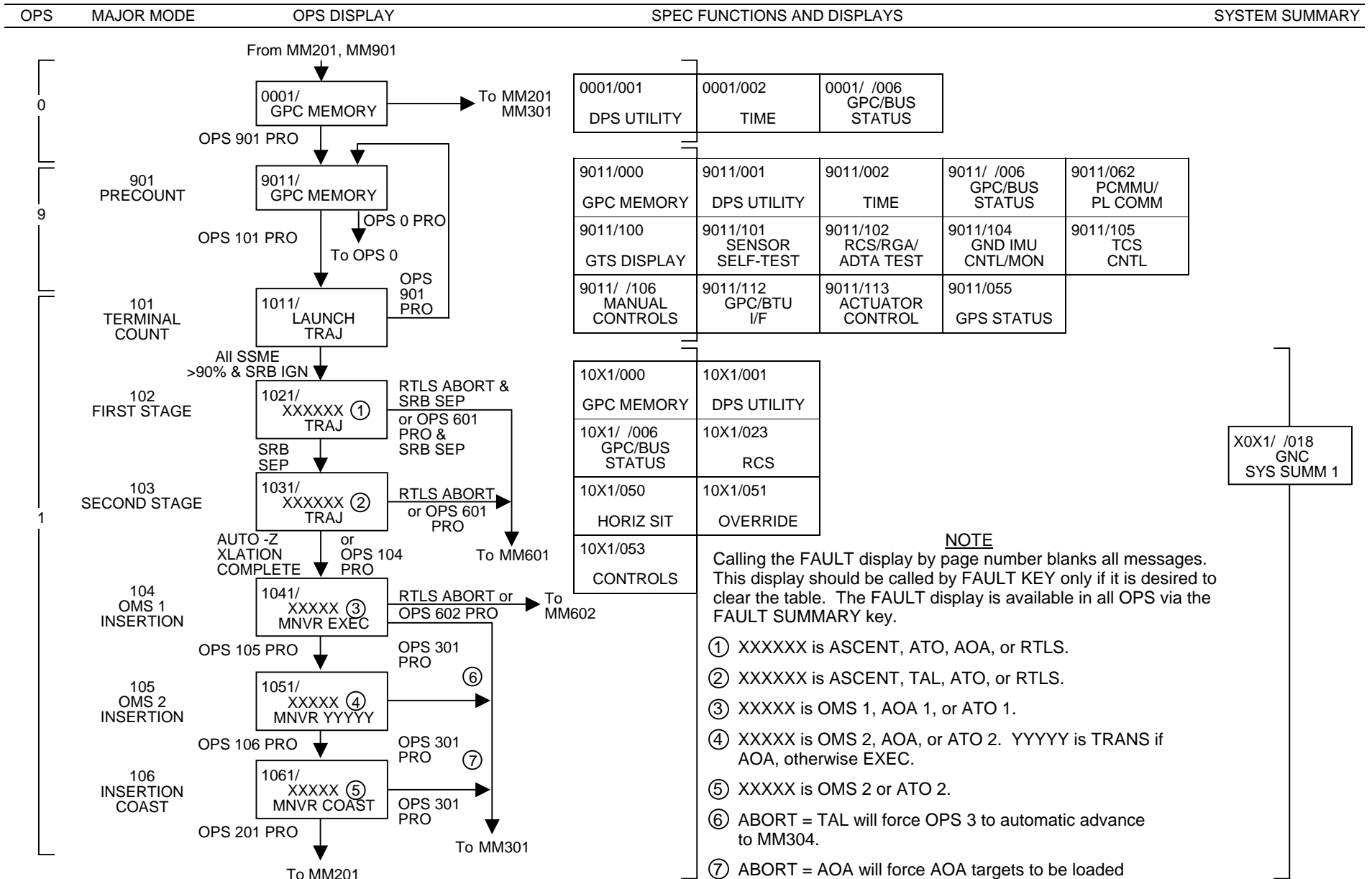



## GNC MAJOR MODE TRANSITIONS AND DISPLAY SUMMARY (PASS) – (Cont)

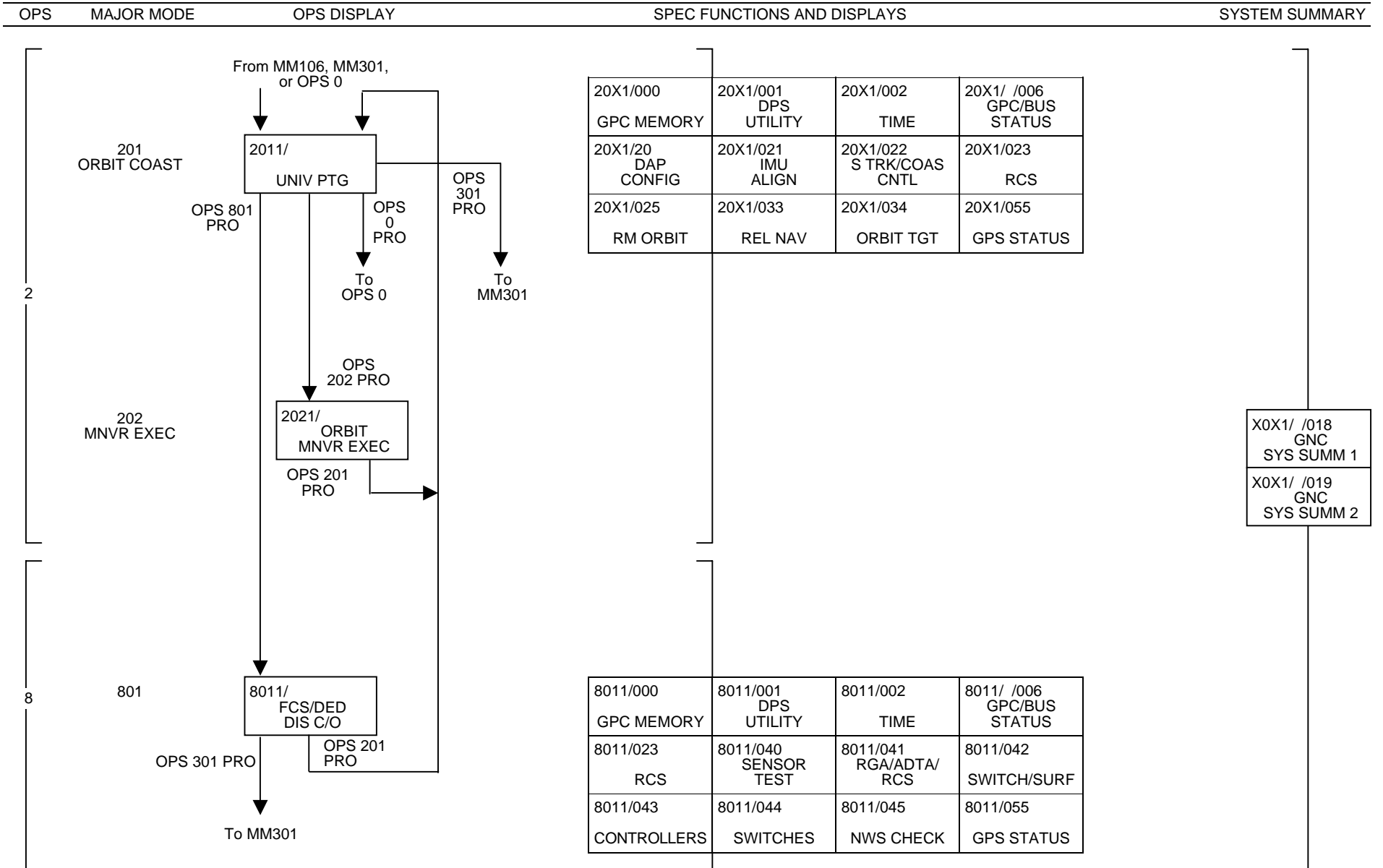

## GNC MAJOR MODE TRANSITIONS AND DISPLAY SUMMARY (PASS) – (Cont)

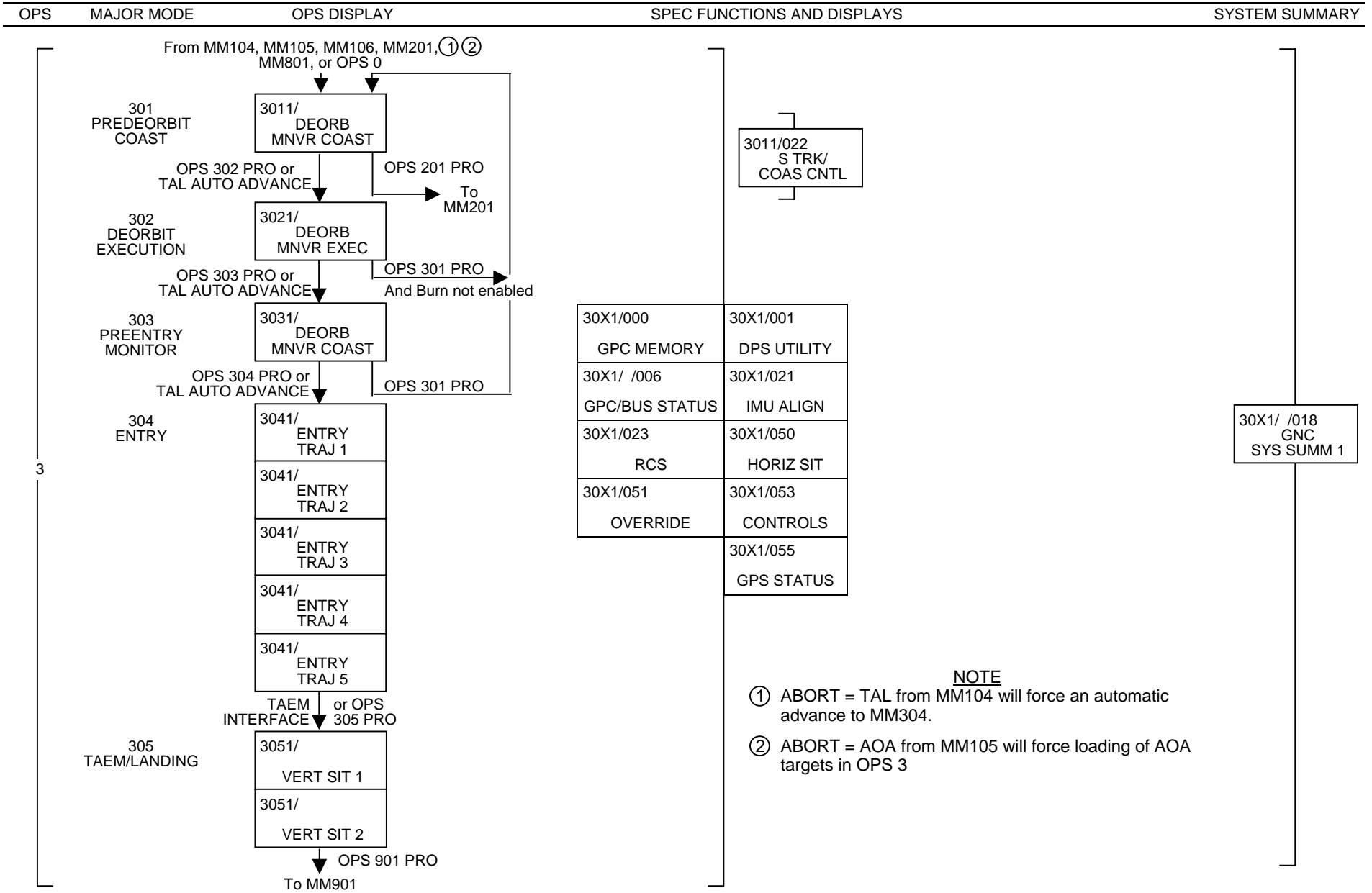

- NOTE**
- ① ABORT = TAL from MM104 will force an automatic advance to MM304.
  - ② ABORT = AOA from MM105 will force loading of AOA targets in OPS 3

GNC MAJOR MODE TRANSITIONS AND DISPLAY SUMMARY (PASS) – (Cont)

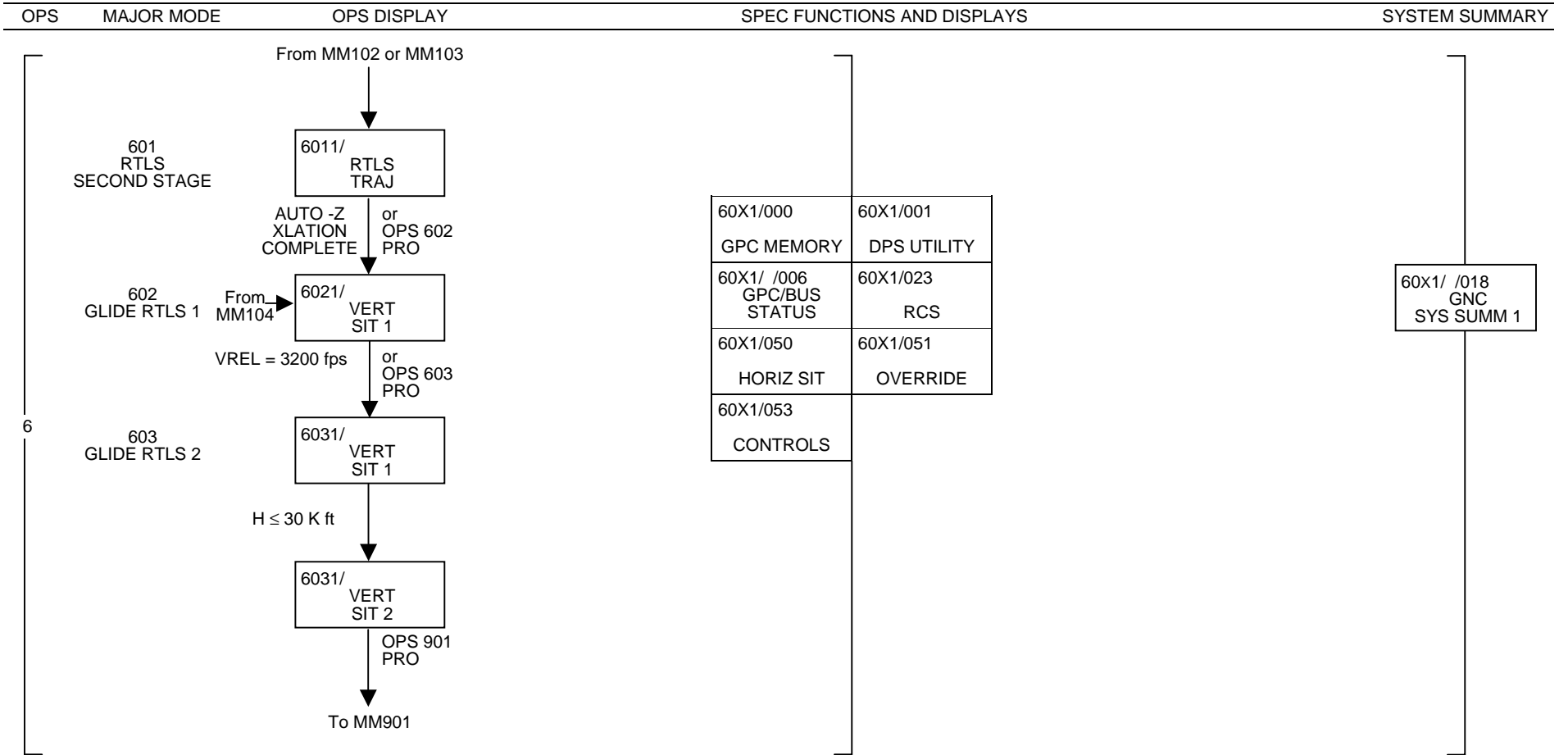

## SM MAJOR MODE TRANSITIONS AND DISPLAY SUMMARY (PASS)

OPS	MAJOR MODE	OPS DISPLAY	SPEC FUNCTIONS AND DISPLAYS	SYSTEM SUMMARY
-----	------------	-------------	-----------------------------	----------------

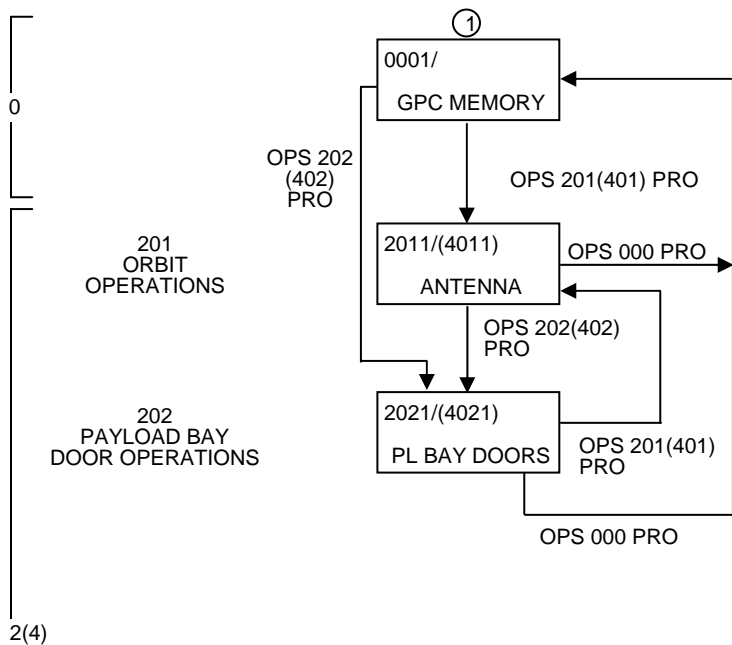

0001/001 DPS UTILITY	0001/002 TIME	0001/ /006 GPC/BUS STATUS
X0X1/000 GPC MEMORY	X0X1/001 DPS UTILITY	X0X1/002 TIME
X0X1/ /006 GPC/BUS STATUS	X0X1/060 SM TABLE MAINT	X0X1/062 PCMMU/PL COMM
X0X1/064 ② SM GROUND CHECKOUT	X0X1/ /066 ENVIRONMENT	X0X1/ /067 ELECTRIC
X0X1/ /068 CRYO SYSTEM	X0X1/ /069 FUEL CELLS	X0X1/ /076 COMMUNICATIONS
X0X1/ /077 EVA-MMU/FSS	X0X1/085 MASS MEMORY R/W	X0X1/ /086 APU/HYD
X0X1/ /087 HYD/THERMAL	X0X1/ /088 APU/ENVIRON THERMAL	X0X1/ /089 PRPLT THERMAL
X0X1/090/ PCS CONTROL	X0X1/094 PDRS CONTROL	X0X1/095 PDRS OVERRIDE
X0X1/ /096 PDRS FAULTS	X0X1/ /097 PL RETENTION	X0X1/ /167 DOCKING STATUS
X0X1/ /168 CARGO LOOP	X0X1/ /169 PDRS STATUS	X0X1/ /177 EXTERNAL AIRLOCK
See PL SYS for Payload Displays		

X0X1/ /078 SM SYS SUMM 1
X0X1/ /079 SM SYS SUMM 2

### NOTE

- ① All possible transitions between OPS 0, SM OPS 2, and SM OPS 4 are legal, including the 201 ← → 401 and 202 ← → 402 transitions which cannot be shown on this simplified flow chart.  
  
SM OPS 4 will be inhibited for flights with no OPS 4 payload requirements; attempting an OPS 401 PRO will result in an 'ILLEGAL ENTRY' message.
- ② Although SPEC 64 is available in SM OPS 2 and SM OPS 4, it is not normally used during on-orbit operations

PL MAJOR MODE TRANSITIONS AND DISPLAY SUMMARY (PASS)

OPS	MAJOR MODE	OPS DISPLAY	SPEC FUNCTIONS AND DISPLAYS	SYSTEM SUMMARY
-----	------------	-------------	-----------------------------	----------------

0  
9

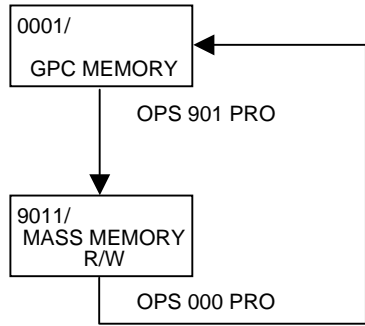

0001/001 DPS UTILITY	0001/002 TIME	0001/ /006 GPC/BUS STATUS	
9011/000 GPC MEMORY	9011/001 DPS UTILITY	9011/002 TIME	9011/ /006 GPC/BUS STATUS
9011/085 MASS MEMORY R/W	9011/100 GTS DISPLAY	9011/111 SL MEMORY DUMP	

## GNC MAJOR MODE TRANSITIONS AND DISPLAY SUMMARY (BFS)

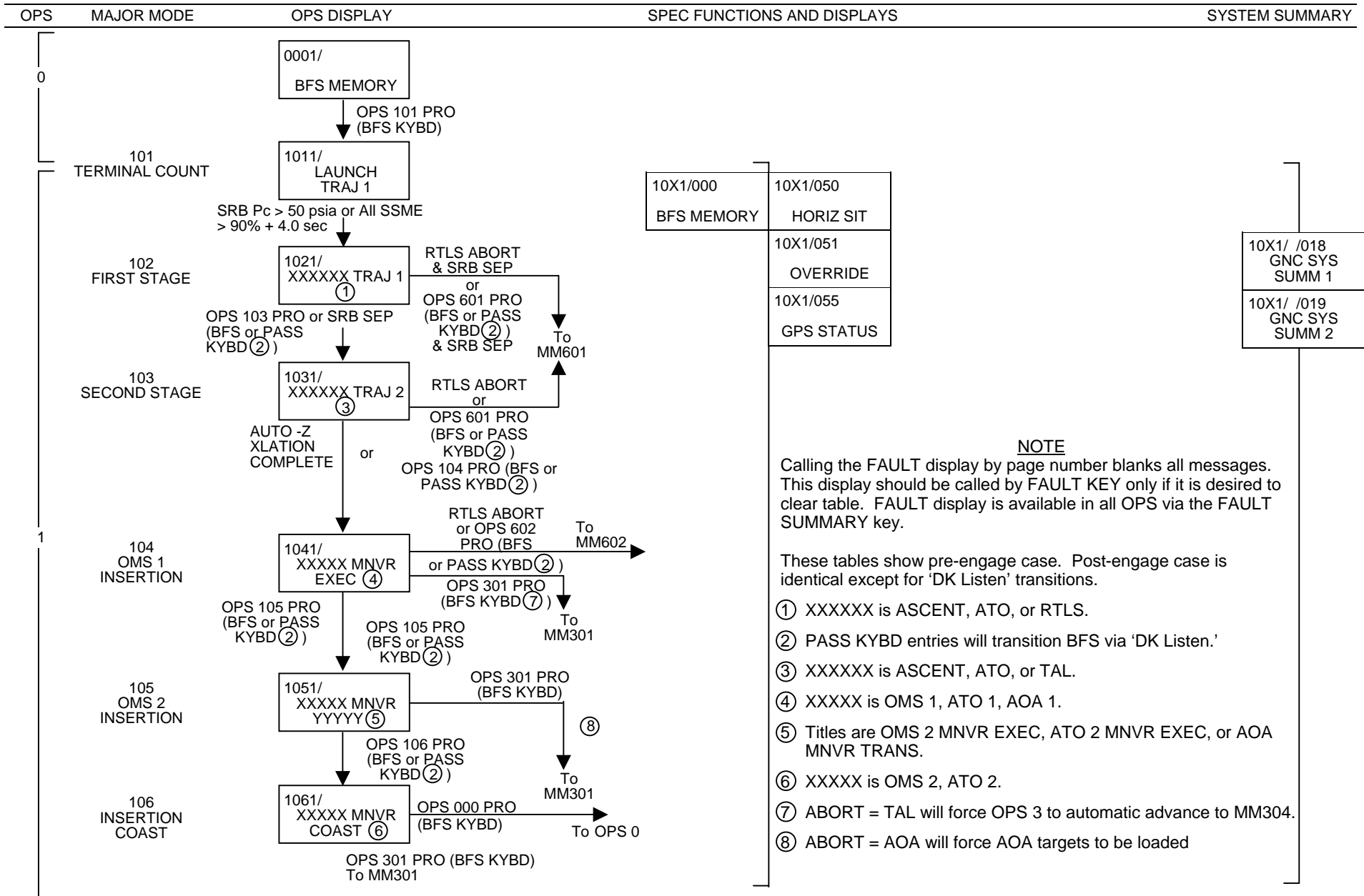

## GNC MAJOR MODE TRANSITIONS AND DISPLAY SUMMARY (BFS) – (Cont)

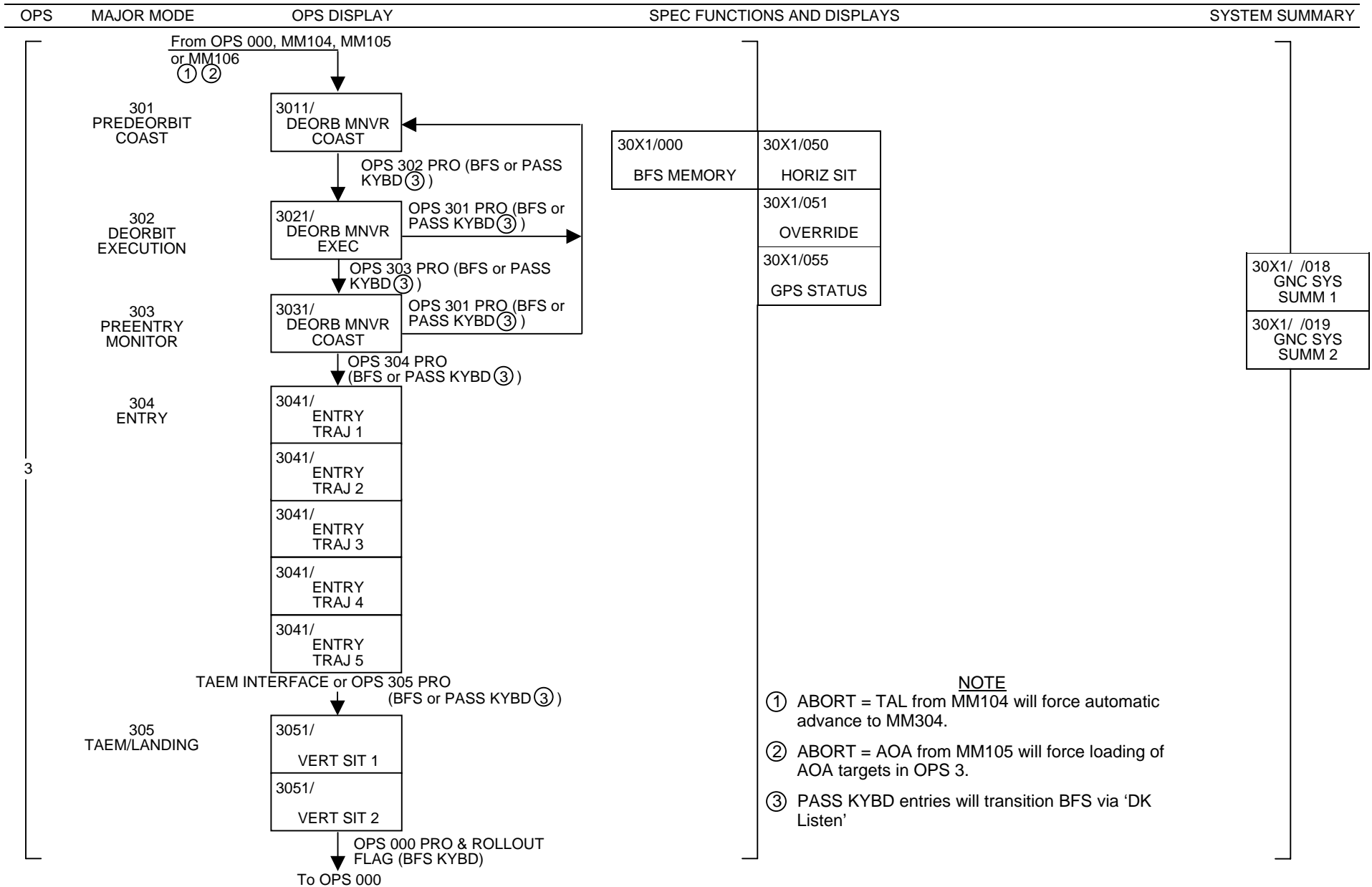

## GNC MAJOR MODE TRANSITIONS AND DISPLAY SUMMARY (BFS) – (Cont)

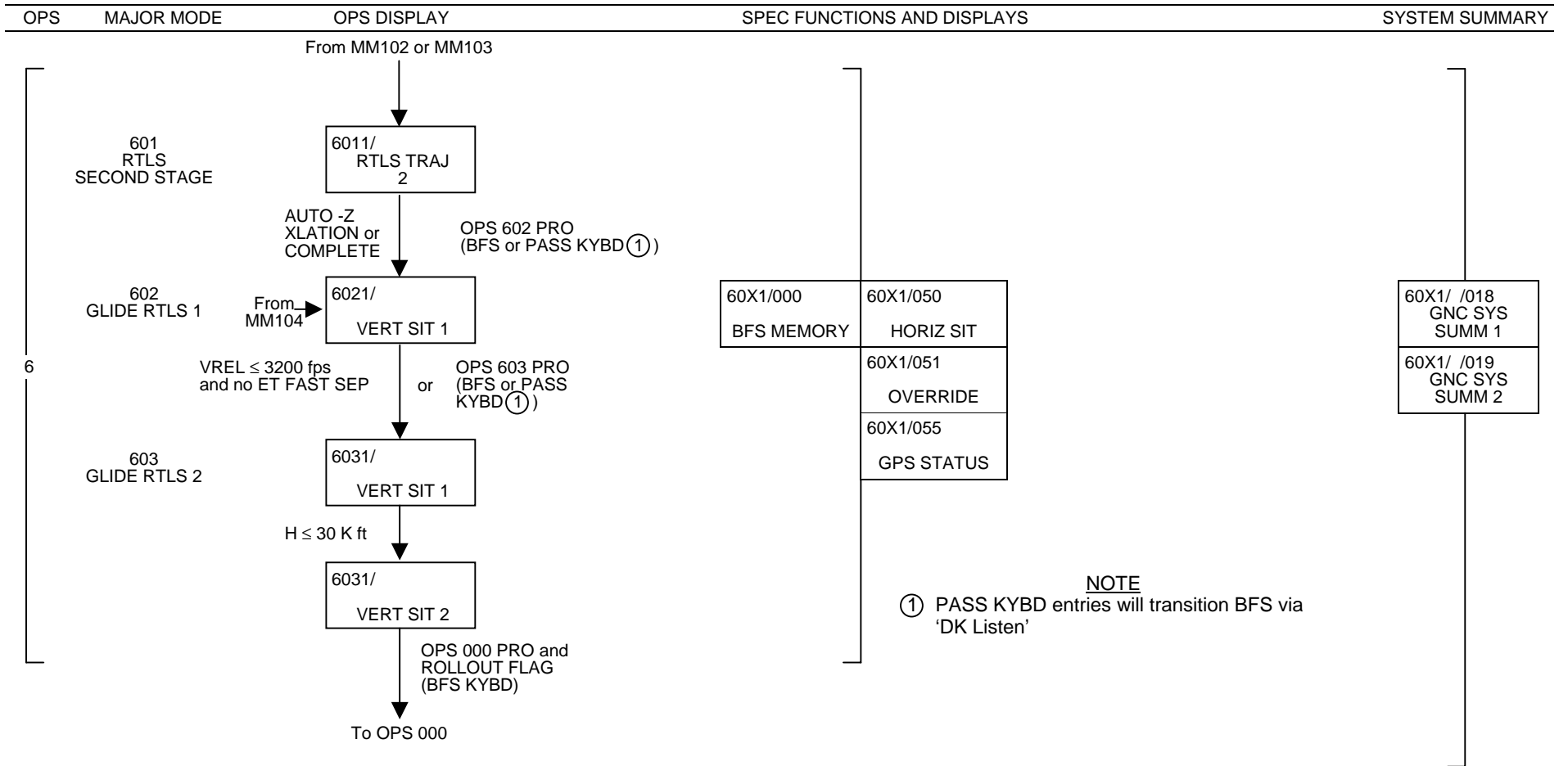



# SM DISPLAY SUMMARY (BFS)

OPS	MAJOR MODE	OPS DISPLAY	SPEC FUNCTIONS AND DISPLAYS	SYSTEM SUMMARY
-----	------------	-------------	-----------------------------	----------------

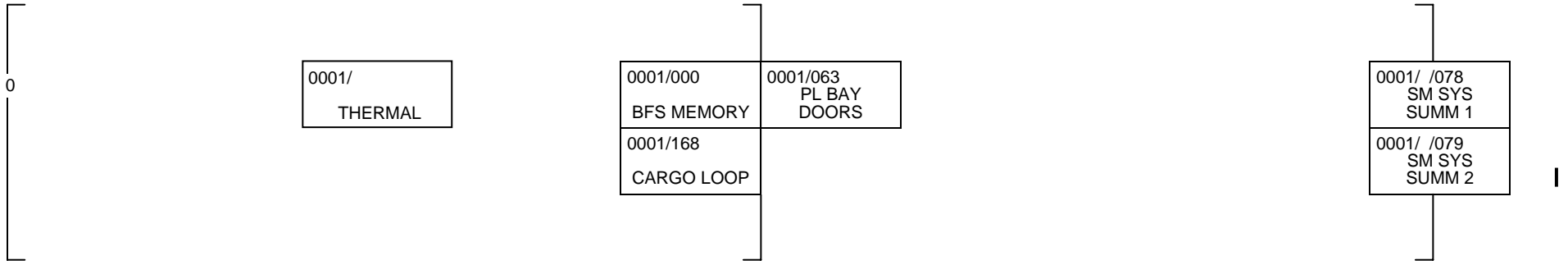

This Page Intentionally Blank

SYSTEM SOFTWARE CRT DISPLAYS

	<u>PAGE</u>
OPS 0001 GPC MEMORY .....	2-2
SPEC 1 DPS UTILITY .....	2-6
*SPEC 2 TIME .....	2-9
DISP 6 GPC/BUS STATUS.....	2-12
DISP 99 FAULT.....	2-13
DEU STAND-ALONE SELF-TEST .....	2-14
XXXXIPL MENU.....	2-16
OPERATIONAL TEST PROGRAM.....	2-18

\*NOT AVAILABLE IN OPS G1, OPS G3, OR OPS G6

**SYS S/W**

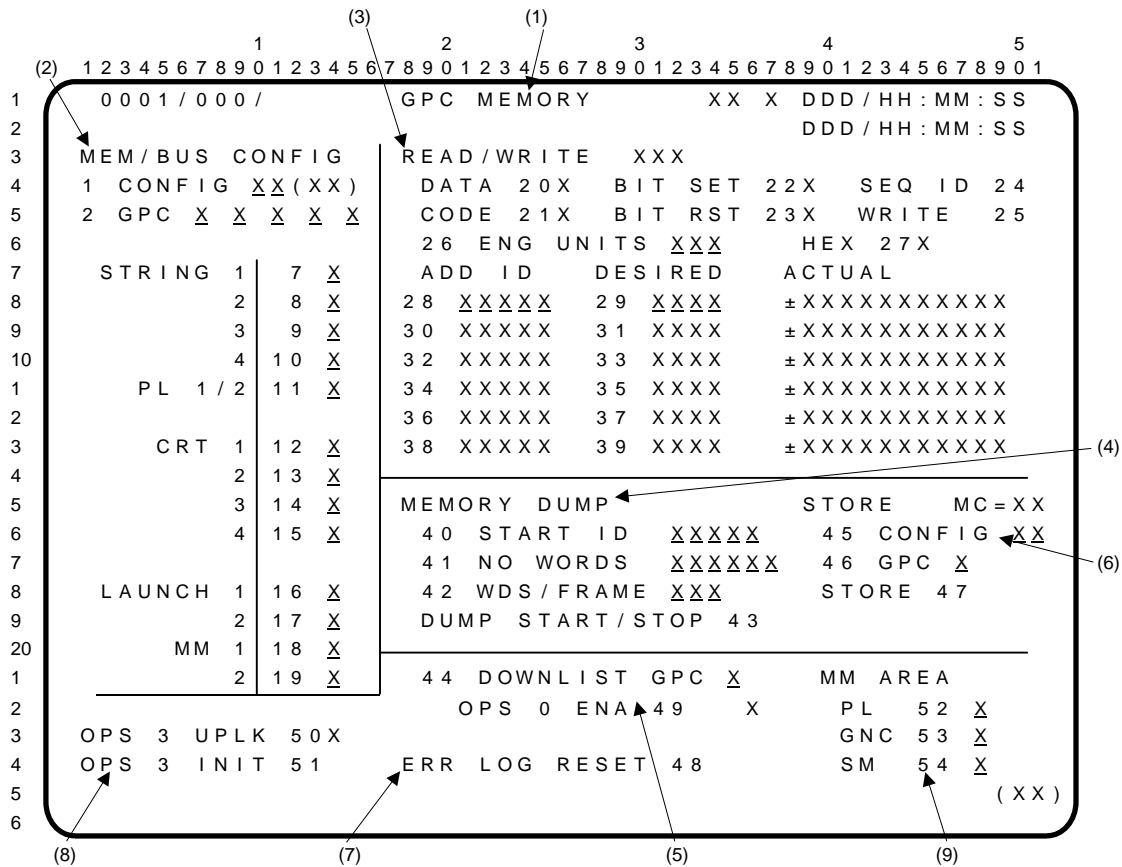

**(1)\*** GPC MEMORY display. This display is the format always associated with OPS 000 and SPEC 000. The GPC MEMORY provides crew controls to: **(2)** review and/or modify the Memory Configuration (MC) and string and bus assignment tables; **(3)** review and change the value contained in any specified GPC MEMORY location; **(4)** provide the capability to perform a main memory dump; **(5)** select the downlist GPC and control the non-prime OPS 0 GPC downlisting; **(6)** perform a GPC freeze dry; **(7)** perform an error log reset; **(8)** control and initialize OPS 3 overlay uplink to GPC in OPS 0; and **(9)** select Mass Memory area for GPC Memory overlay.

**(2)\*** MEM/BUS CONFIG. The desired MC is input (item 1) and the corresponding MC/GPC and MC/STRG assignments and calling OPS number are displayed. The calling OPS identifies to the user the OPS that must be called to initiate loading of the input MC. The OPS number is indicated by major function (G, S, or P) and numeral. The MC/GPC assignments may be modified by inputting the desired GPC in the appropriate location (items 2 thru 6). Deselection is done by inputting zero (0) in the appropriate location for each GPC. The GPC/STRG assignments may be modified by inputting the desired GPC for each string via items 7 thru 10. The bus assignments may be modified by inputting the desired GPC for each bus via items 11 thru 19.

G3 Memory/Bus assignment will be determined via the OPS 1 Memory/Bus configuration during the OPS 1 to OPS 3 transition as long as item entries (2 thru 19) have not been performed during OPS 1, which will alter the G3 nominal Memory/Bus configuration.

Memory configuration selection controls are initialized to blank the first time the OPS/SPEC is called; from then on, the display reflects the crew inputs.

**(3)\*** READ/WRITE. Quantities stored in memory are displayed as follows: The memory addresses of the parameters are input in the ADD ID column using items 28, 30, 32,... 38. When this entry is made, the specified parameter is displayed in the ACTUAL column in the units specified by item 26 Engineering Units (ENG UNITS) or item 27 hexadecimal (HEX). Execution of item 24 (SEQ ID) displays sequential memory locations starting with the most recently entered ADD ID until the display is filled. Executing item 24 or entering individual ADD IDs causes the corresponding DESIRED field(s) to blank. The parameters are scaled according to item 26 or 27.

Definitions of the three-digit inputs for item 26 are on page 2-5.

## GPC MEMORY (Cont):

For item 26 entries of 200 thru 210, the ACTUAL column displays a fixed EU format of XXXXX.XXXXX. If the converted value is 100,000 or greater, the high order digits are not displayed. In such a case, use of the HEX feature (item 27) is recommended to prevent confusion.

All changes to memory are done in an arm/fire manner. The parameters to be changed are specified by displaying the required memory locations as described previously by entering the new value in the DESIRED column using items 29, 31, 33,... 39 and executing item 25 (WRITE).

Desired entries are in HEX only. The major function selected as the destination for WRITE inputs is identified by the major function (MAJ FUNC) switch on the inputting CRT and is displayed. The display is initialized with item 20 (DATA) selected so that WRITE operations apply to unprotected areas of memory. If item 21 (CODE) is executed, the word 'CODE' flashes and the next WRITE operation can alter protected areas of memory. After that WRITE is completed, the mode switches back to DATA.

Individual bits in the unprotected memory area can be set or reset by using items 22 (BIT SET) and 23 (BIT RESET) to establish the required mode, displaying the parameter to be changed, entering a 4-character hexadecimal word (MASK) in the DESIRED column, identifying the bits to be set or reset, and executing item 25 (WRITE). Up to six parameters may be changed with one WRITE. Parameters to be changed must be displayed in HEX.

Items 20 and 21, 22 and 23, and 26 and 27 are mutually exclusive and the active item is designated by an '\*' displayed next to the item number. Selection/reselection of item 26 or 27 clears the ADD ID, DESIRED, and ACTUAL data fields.

NOTE: When the GPC MEMORY SPEC is called, the READ/WRITE and MEMORY DUMP sections are initialized to DATA, HEX, and all other fields blank. If GPC MEMORY is being viewed as an OPS display and on another DEU driven by the same GPC or RS the GPC MEMORY SPEC is requested, both displays will be initialized to the default item selections previously described. In configurations where the GPC MEMORY SPEC is available as the OPS display, view it as the OPS display by resuming any other SPEC or display on the DEU when reinitialization is not desired. Request SPEC 0 when reinitialization is desired. (DR 37516)

- (4) MEMORY DUMP. Items 40 (START ID) and 41 (NUMBER WDS) define the main memory data to be dumped via the downlist. The absolute main memory address, in hexadecimal, of the start of the dump is entered in item 40, and the number of sequential 16-bit words of main memory to be dumped is entered via item 41. If the sum of the starting address and the number of words exceeds the GPC address limit, an error message is generated.

Item 42 (WDS/FRAME) defines the number of 16-bit words in the downlist frame to be used for header and main or mass memory data. Entry of item 42 varies the length of the data content of the downlist frame so that a subset of the total downlist frame can be used for the 64 kbps downlink frame. The item entry is in decimal.

Item 43 (DUMP START/STOP) serves a dual purpose. For a dump initialized using values in items 40 (41, 42), item 43 selects the dump. Upon entry of this item, START ID (item 40) begins incrementing, NUMBER WDS (item 41) will decrement. At dump completion, items 40, 41, and 42 will blank.

For a single item entry dump (standard table I-loaded values for item 40, 41, and 42), item 43 starts the dump. It also serves as a toggle switch to stop a dump that is already in progress.

- (5) DOWNLIST GPC. Item 44 (DOWNLIST GPC) allows manual selection of a GPC within the common set (CS) for downlisting. The GPC currently commanding Pulse-Code Modulation Master Unit (PCMMU) toggle buffer 1 (the prime downlist buffer) is displayed, so the ID of a newly selected GPC will not appear until that GPC has taken control of the toggle buffer. IDs other than 1 thru 5 will be rejected and 'ILLEGAL ENTRY' displayed.

Item 49 (OPS 0 ENA) provides the capability to alternately enable and disable the downlist of a non-prime OPS 0 GPC. This item is initialized with the downlist disabled. An '\*' is displayed next to item 49 when this item is enabled.

## GPC MEMORY (Cont):

- (6) Three item numbers are provided to allow the crew to load a desired MC into a target GPC without initiating an execution of the associated application software operational sequence. Item 45 (CONFIG) selects the desired memory configuration, item 46 (GPC) selects the target GPC, and item 47 (STORE) initiates the load. When STORE MC equals the input CONFIG, the load is complete.
- (7) Item 48 provides the capability to reset the I/O error log, GPC error log, soft error counter and DEU IPL error log; restart the sync history log; and reset the Computer Annunciation Matrix (CAM).
- (8) Item 50 enables/disables the OPS 3 uplink and item 51 initializes the GPC after OPS 3 has been uplinked. Item 50 entry when the memory configuration is not an overlay and item 51 entry when item 50 is deselected will result in an 'ILLEGAL ENTRY' message.
- (9) Items 52 thru 54 provide for the selection of Mass Memory area to be used by GPC Memory overlays. Mass Memory areas 1, 2, or 3 are selected by PL, GNC, and SM Major Functions, respective to the aforementioned item entries. The value of the selected Mass Memory area will be maintained across the common set. Selected area number displayed beside the item number will initially reflect the copy used during IPL and will change after item entry execution. Memory overlays will acquire data from the specified Mass Memory areas. Mass Memory area selections other than 1, 2, or 3 will be rejected, and an 'ILLEGAL ENTRY' message will be displayed.

## \*PROGRAM NOTES

- (1) Mass Memory Pre-position Failure. When a mass memory pre-position failure occurs, SPEC 0 does not appear on the DEU where the OPS request was made. During TAL abort (G1 to G3), if the OPS 0 page is not displayed within 12 seconds, a mass memory pre-position failure can be assumed. For other transitions, a 70-second wait is required. An 'I/O ERROR MMU' message may appear on the Fault Summary Page (FSP) and on the CRT message lines when the failure occurs. (DR 25372)

- (2) Stale NBAT Data. If the MC # displayed (item 1) is the currently active MC, the DEU selections (items 12, 13, 14, 15) will not reflect any CRT reassignments that have occurred due to an MF change or GPC/CRT entry.

If the G3 NBAT is not updated in OPS G1, the active G1 bus assignment is carried over at the OPS G1 to G3 transition as the G3 bus assignment. After the G1 to G3 transition, the string/bus assignments displayed are stale data from the MC3 NBAT previously displayed in OPS G1. Selecting item 1+3 on SPEC 0 after the transition to OPS G3 will update the display with the current G3 NBAT. (DR 37506)

- (3) Engineering Units Conversion Processing. Processing of read/write information continues in the software even if the GPC MEM SPEC is removed via a RESUME. If an improper engineering units conversion is requested, GPC errors may occur if the SPEC is RESUMEd without first doing an ITEM 27 EXEC to clear the read/conversion function.

G-MEM Item Initialization. The ADD ID and DESIRED columns are blanked at OPS transitions or a fresh callup of SPEC 0, but not if SPEC 0 is active on another DEU or is underlying a DISP when it is called. A DEU equivalent G-MEM in the latter situation could produce an erroneous write to GPC memory. Reinitialization via an item 20 should always be performed prior to DEU equivalent G-MEM writes.

GPC MEMORY (Cont):

Item 26 Inputs:

Digit 1

1 – 16 bit/fixed

2 – 32 bit/floating

Digits 2 and 3

00 – Units in Memory (no conversion)

01 – NM from FT

02 – NM from KFT

03 – FT from NM

04 – KFT from NM

05 – FT/SEC<sup>2</sup> from Gs

06 – DEG/SEC from MR/SEC

07 – DEG from ARC SEC

08 – FT/SEC<sup>2</sup> from micro Gs

09 – DEG from Radians

10 – KFT from FT

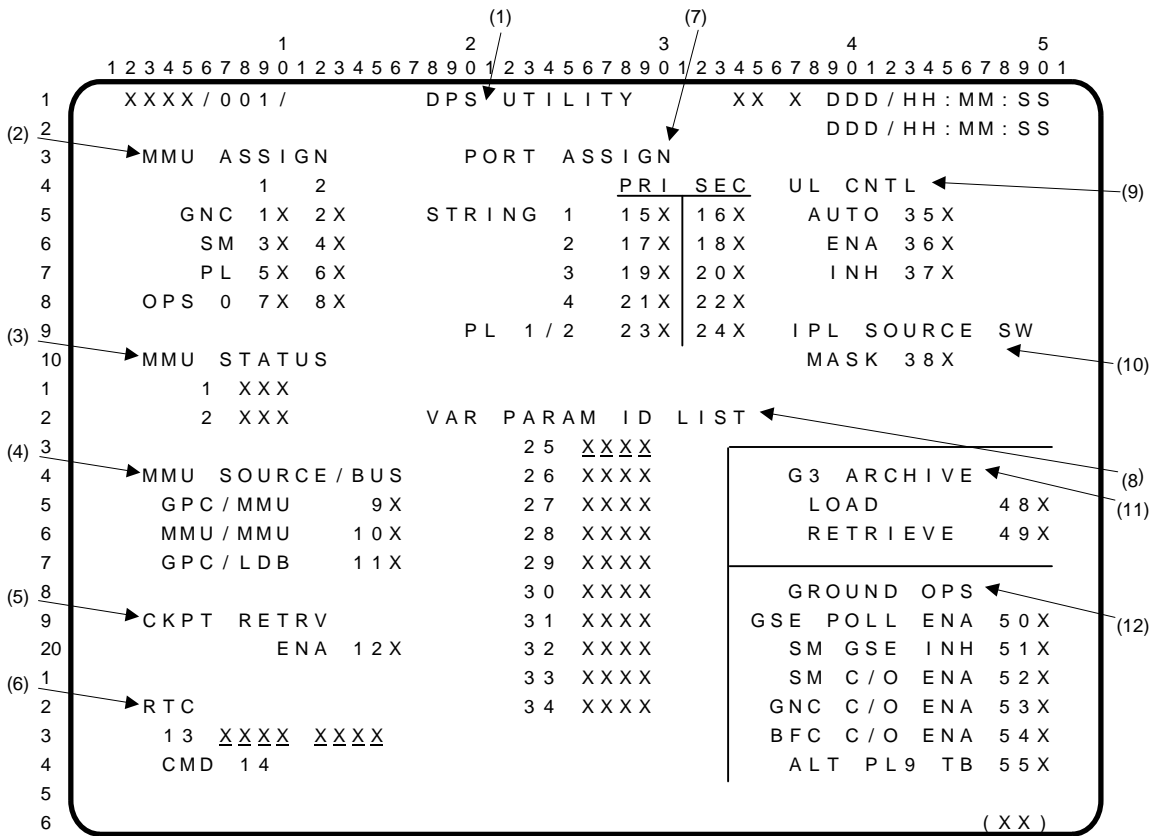

**(1)** DPS UTILITY. This display is the format associated with SPEC 001, available in all OPS. DPS UTILITY provides controls to: **(2)** assign a major function to Mass Memory Units (MMU 1 and MMU 2); **(3)** provide the status ('RDY' or 'BSY') for each MMU; **(4)** select the memory source and bus for GPC reconfiguration; **(5)** and **(6)** enable checkpoint data retrieval from the MMUs and provide Real Time Command inputs; **(7)** select primary or secondary ports for strings 1 thru 4 and the PL MDMS; **(8)** select variable parameters for use in the downlist format; **(9)** select uplink control; **(10)** mask IPL source select discrettes; **(11)** enable load and retrieve G3 archive program overlay; **(12)** maintain ground checkout operations.

**(2)** MMU ASSIGN. Items 1 thru 8 are the controls to assign a prime MMU to each major function. Only one MMU may be assigned to a major function. The display is initialized with the GNC, PL, SM major functions, and OPS 0 functions assigned to MMU 1. '\*'s are displayed next to the item numbers to indicate the various assignments. These items should not be executed if the CRT is assigned to a non-PL9 GPC and PL9 operations are in progress in another GPC. The PL9 mass memory utility process may use a Mass Memory other than that assigned in the Mass Memory Major Function table, but does not ICC the new selection to other GPCs. User selection of MMU assignments on the DPS UTILITY SPEC from another GPC can interfere with the proper operation of PL9 MM Utility. (DR 37420)

**(3)** MMU STATUS. The status of MMUs 1 and 2 is displayed as 'RDY' or 'BSY'.

**(4)** MMU SOURCE/BUS. Items 9, 10, and 11 select the memory source (i.e., MMU or another GPC) and data path for non-Initial Program Load (IPL) memory reconfigurations.

A. GPC/MMU (item 9)  
Any available GPC using either available MMU bus as the path. If the desired load is not in a GPC, the logic defaults to use the MMU.

B. MMU/MMU (item 10)  
The available MMU (MMU 1 or MMU 2) using its data bus. When this control is executed, the appropriate major function/OPS overlay is retrieved from the MMU and loaded into the assigned GPC, regardless of its current contents (i.e., the load is forced).



DPS UTILITY (Cont):

C. GPC/LDB (item 11)

Any available GPC using Launch Data Bus (LDB) as the path. If a GPC source for the required overlay is not available, the request is rejected and an 'ILLEGAL ENTRY' message is generated. If item 11 is selected, there is no automatic reselection of item 9.

Only one option may be active at any time; an '\*' denotes the latest selection. The display is initialized with item 9 selected.

- (5) CKPT RETRV ENA. Item 12 enables the retrieval of checkpoint data from Mass Memory. This item is initialized INHIBITED. Enabling is a one-shot function in that checkpoint retrieval is automatically inhibited at the completion of the retrieval function. Item 12 changes the checkpoint retrieval status to the opposite of the current (enabled or inhibited) state. An '\*' beside item 12 indicates that checkpoint retrieval is enabled.
- (6) RTC. Items 13 and 14 provide the capability to use the Real Time Command (RTC) function. Eight hexadecimal characters which represent the components of an RTC are entered via item 13. Item 14 executes the data entered by the RTC item. The user is required to ensure that the major function controlling the GPC Memory SPEC has the data buses over which the RTC is requested to be transmitted.
- (7) PORT ASSIGN. Strings 1 thru 4 may be assigned to the primary port (Port 1) or the secondary port (Port 2) of all Multiplexer/Demultiplexers (MDMs) on that string via items 15 thru 22. When the primary is selected, the lowest numbered FC bus of the pair is used to drive the Flight-Critical Forward (FF) MDM, and the other is used to drive the Flight-Critical Aft (FA) MDM. When the secondary is selected, the lowest numbered bus of the pair is used to drive the FA MDM; the other is used to drive the FF MDM.
- Similarly, the PL MDMs may be assigned ports via items 23 and 24. A primary assignment provides access to MDM PL 1 – port 1, and MDM PL 2 – port 2, via PL buses 1 and 2, respectively. A secondary assignment provides access to MDM PL 1 – port 2, and MDM PL 2 – port 1, via PL buses 2 and 1, respectively.
- Assignments are initialized to primary following IPL and remain in effect until a subsequent manual input.
- (8) VAR PARAM ID LIST. Variable parameters consist of a set of 10 memory locations (16-bit) that may be selected for incorporation into the downlist. These parameters are initialized to a nominal set of parameters that can be overwritten with new parameters via this SPEC or special UPLINK LOAD. Items 25 thru 34 are used for this function. The new parameters are defined by entering the absolute main memory address in hexadecimal. Only memory core locations from 0000 to FFFF can be selected. Changes are effective when input and remain effective until changed.
- (9) UL CNTL. Items 35 thru 37 provide for the selection of manual or automatic enabling or inhibiting of uplink. The display is initialized with item 36 (ENA) selected.
- (10) IPL SOURCE SW. Item 38 is used to allow for control over software use of the IPL source select discrettes for non-IPL use of the MMUs. The entry is used to mask or unmask the discrettes. The presence of an asterisk indicates that the discrettes are masked. If no asterisk is displayed, the discrettes are not being masked. When masked, the FCOS shall ignore the status of the MMU1 IPL and MMU 2 IPL select discrettes in determining the availability of an MMU to support a request for MMU I/O other than an IPL. The mask shall be initialized to the unmasked state during primary GPC initialization except that the initialization of memory configuration 1 (GNC OPS 1) shall set the mask to the mask state. After MC1 initialization, the discrettes can be unmasked by execution of item 38. Each time the display is called, or upon execution of an item 38 entry, the item 38 asterisk will reflect the actual status of the FCOS mask for the discrettes. This capability is available to all GPCs that are in the common set.

DPS UTILITY (Cont):

- (11) G3 ARCHIVE FUNCTION. Items 48 and 49 provide enable/inhibit control of the G3 program overlay to be loaded into GPC upper memory during the G9 to G1 OPS transition. Item 49 (which is initialized disabled) controls the retrieval of the GPC memory overlay during G3 transitions.

Toggling either item 48 or item 49 results in the selection of the alternate control state. An '\*' denotes which item is enabled. Selection of item 48 is valid only in OPS G9; whereas selection of item 49 is valid in G1, G2, G8, and OPS 0.

Once item 48 is enabled, item 49 is automatically disabled until the G9 to G1 OPS transition is complete. If the G3 load function is successful, item 48 will be disabled and item 49 enabled. This change from load function to retrieve function enabled is a positive indication that all of the participating GPCs have obtained the G3 archive program overlay.

- (12) GROUND OPS. Items 50 thru 55 are provided to facilitate launch site ground checkout of orbiter vehicle functions. Item 50 (GSE POLL ENA) provides the capability to enable/disable ground support equipment (GSE) polling. It is initialized disabled (no '\*') and is automatically disabled at SRB ignition. Item 51 (SM GSE INH) provides the capability to inhibit GSE Polling upon entry to any SM OPS; the item is initialized to allow GSE polling in SM (no '\*'). Item 52 (SM C/O ENA) provides the capability to enable/disable the Systems Management checkout software function in SM OPS 2 or 4, while item 53 (GNC C/O ENA) can be used to enable/disable the GNC checkout software. Both items are initialized disabled (no '\*').

Items 51, 52, and 53 are valid only in G9 and OPS 0, while item 50 is valid in OPS G9, P9, and Post IPL OPS 0. The selected status of each is maintained Common Set-wide. Execution of these items in any OPS other than those specified shall result in an 'ILLEGAL ENTRY' message. Items 38 thru 49 are implied. Execution of items 38 thru 49 shall also result in an 'ILLEGAL ENTRY' message.

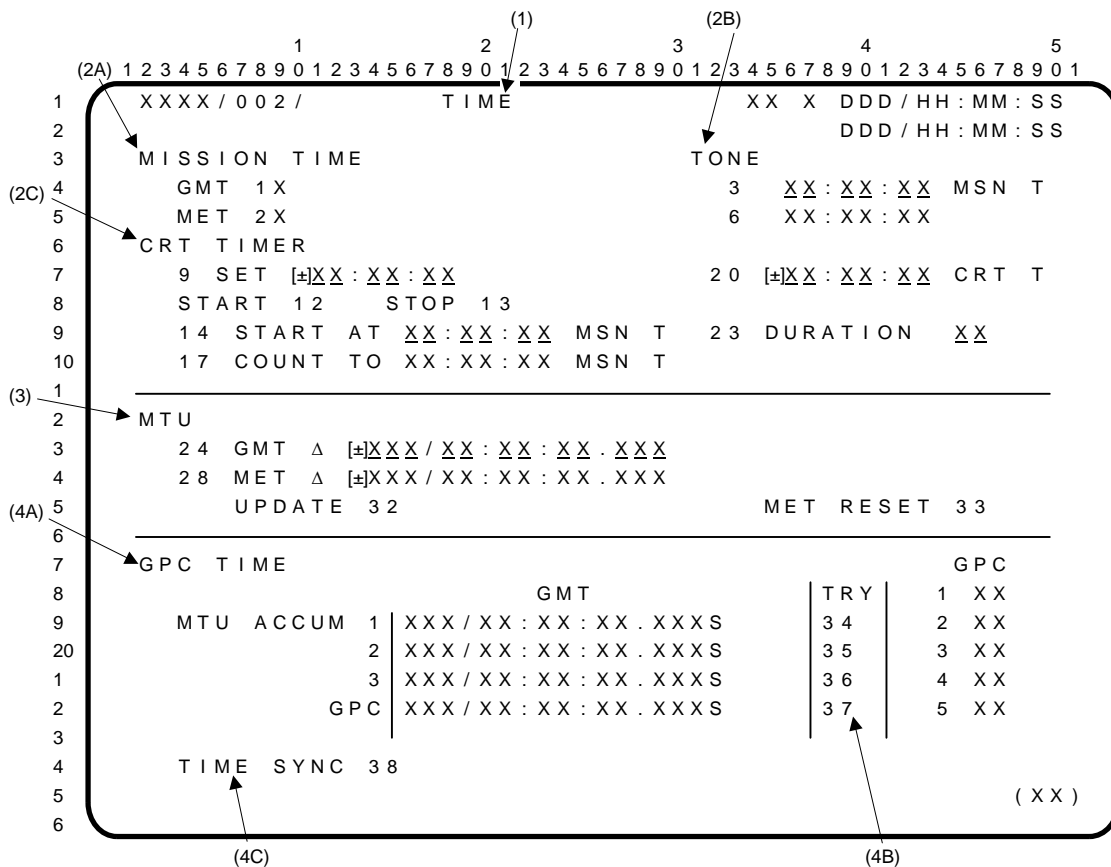

- (1) TIME display. A system level specialist function (SPEC 2) available in all OPS sequences except GNC OPS 1, 3, and 6. Includes: **(2A)** controls for MISSION TIME (MT) and the **(2C)** CRT TIMER (CRT T) for all CRT displays; **(3)** controls to update the Master Timing Unit (MTU – both Greenwich Mean Time (GMT) and Mission Elapsed Time (MET)); and **(4A)** controls to monitor and manage the GPC TIME sources.
- (2) **(2A)** MISSION TIME. Item 1 selects GMT to be displayed as the MT on all CRT displays. Item 2 selects MET to be displayed. An '\*' is displayed opposite the selected source, and a blank indicates that a source (GMT or MET) is not selected for driving MT. Display is initialized following a GPC IPL with GMT selected. (Note: By using the MET Δ UPDATE controls (see **(3)**) the capability exists to make MET read in elapsed time from lift-off (or any other time reference), or to read in any clock time, such as Central Standard Time (CST), Central Daylight Time (CDT), etc.). Two alert tone controls are provided for MT (see **(2B)**).

**(2B)\*** TONE. Items 3 thru 5 are used to enter a desired MT (hr:min:sec), at which an alert tone sounds and the data field blanks. Items 6 thru 8 provide the capability to set an additional MT, and work the same as items 3 thru 5. Items 20 thru 22 are used to enter a desired CRT T time (hr:min:sec), at which an alert tone sounds and the data field blanks. If a '-' is loaded, the alert tone sounds prior to the CRT T reaching zero. If a '+' is loaded, the alert tone sounds after passing zero. Values entered which are in the past relative to the CRT TIMER will cause an immediate alert. The sign of the lowest item number entered determines the sign of the set. Item 23 is used to designate the desired alert tone DURATION in seconds for all alerts. (Initial time duration is 1.0 seconds.) If item 23 is set to zero, the tone is inhibited.

NOTE: An appropriate message (TIME TONE) appears on the Message Line to allow the crew to positively differentiate between a tone caused by a detected fault and one set with these controls.

**(2C)\*** CRT TIMER. Items 9 thru 11 are used to load a time (±hr:min:sec) in the CRT T. The sign of the lowest non-zero item number entered shall determine the sign of the entire set. If a '+' is loaded, the CRT T will count up. If a '-' is loaded, the CRT T counts down to zero, then up. Item 12, when executed, starts the CRT T, and blanks the fields of items 9, 10, and 11. Item 13 is used to stop the CRT T. (TIMER zeroes when stopped.) Items 14 thru 16 are used to designate an MT (hr:min:sec) at which the CRT T will start counting from the value loaded in items 9 thru 11. When counting is initiated, the fields in items 9 thru 11 and items 14 thru 16 blank. Items 17 thru 19 are used to designate an MT, to which the CRT T counts down. When

## TIME (Cont):

zero is reached on the CRT T, the data fields for items 17 thru 19 are blanked. Whenever the display is recalled, the last 'count to' MET is displayed in items 17 thru 19.

NOTE: A CRT timer initiated and counting at the time of an OPS transition will continue to count across the transition and in the new OPS, even if the TIME spec is not available in that OPS. However, crew inputs for START AT mission time and alert TONE DURATION will be nullified by overlay of a memory configuration that does not contain this spec.

- (3)\*** MTU. Items 24 thru 27 are used to load into the MTU a desired time correction ( $\Delta t$ ) to GMT. Items 28 thru 31 are used to load a desired time correction ( $\Delta t$ ) to MET. The sign of the lowest non-zero item number entered shall determine the sign of the entire set. Item 32 actually updates the MTU with the values (day:hr:min:sec.msec) loaded in items 24 thru 27 and/or items 28 thru 31.

NOTE: Due to hardware limitations, there is a time lapse of up to two minutes from the time item 32 is selected until a GMT update actually takes effect. During this period, OPS transitions, OPS mode recalls, I/O terminate switch changes, accumulator selects, and I/O RESETs should be avoided because they may induce a GPC fail-to-sync.

The GMT/MET update item entries blanked following an execute of item 32. Items 24 thru 27 and 28 thru 31 are mutually exclusive. Entry of any one of items 24 thru 27 or 28 thru 31 blanks any input present in items 28 thru 31 or 24 thru 27, respectively. The value of the update is rejected if the request is for more than 15 msec, except when the GPC is in OPS 0 and is the only common set GPC. Updates greater than 15 msec cause time reinitialization. Item 33, MET RESET, resets the MET to 0 in both the MTU and the common set GPCs resulting in equalization of GPC and MTU MET.

- (4)** **(4A)** TGPC TIME. A readout is provided of the actual GMT (day:hr:min:sec.msec) being maintained by each of the MTU accumulators (MTU ACCUM 1, 2, 3) and the internal GMT being maintained by the selected GPC. Results of the time management processor filter for input source failures are displayed adjacent to each GMT readout, a '↓' to indicate a failure, or an 'M' to indicate data loss.

During primary GPC time initialization, GMT and MET are limit checked against the following criteria:

days: 1-399 (0-399 for MET)  
hours: 0-23  
minutes: 0-59  
seconds: 0-59

If either the GMT or MET fails these limit checks, the selected time source will downmode to GPC time. Attempt to correct the problem by performing an initial GMT update followed by a TIME SYNC (item 38) to initialize GMT and reset MET.

- (4B)** TRY. Items 34, 35, 36, and 37 are used to force all GPCs to try to use MTU ACCUM 1, 2, 3, or the selected GPC, respectively, as their time source. The actual time source being used by each GPC is indicated by displaying an identifier (A1, A2, or A3 for ACCUM 1, 2, or 3, respectively; or G1-G5 for GPC 1-5, respectively).

When reselecting an MTU accumulator for a computer set which has defaulted to GPC time, the '↓' is blanked only for the specific accumulator which has been successfully selected. If the other accumulators are now working properly, ignore their '↓'s or manually reset each arrow by momentarily selecting each accumulator via its TRY item number.

- (4C)\*** TIME SYNC. Item 38 is used to synchronize the time sources to the time source currently selected by the lowest GPC ID in the common set having control of at least one of the Flight Critical (FC) 1-3 buses. Following the time sync procedures, the Time Management Processor (TMP) selects MTU ACCUM 1 as the time source. Performing a time sync with GPCs split between accumulator and GPC time sources will cause a fail-to-sync. In this situation, do an item 37 to get all GPCs on GPC time prior to performing the time sync.

TIME (Cont):

\*PROGRAM NOTES

**(2B) (2C) (3)** Sign Convention for Item Entries. The sign of the lowest non-zero item entry value determines the sign for the entire field. Since the S/W cannot interpret negative zero, the user should enter the desired sign immediately preceding the first non-zero entry (+ or -) or not use zero as the first digit in a series of entries to the items. (DR 37504)

**(3)** GMT Update on GPC Time. If a GMT update is issued from either a redundant set GPC or a nonredundant set GPC while on GPC time, there is a possibility that the redundant set GPC could perceive different time than the non-redundant set GPC. This could lead to a common set fail-to-sync of the non-redundant set GPC.

MTU Effects on GMT Updates. When a Greenwich Mean Time (GMT) update (item 32) is executed, there is an interval of up to 2 minutes before the update takes effect as indicated by the GMT  $\Delta$  blanking on the display. The length of the delay is a function of the Master Timing Unit (MTU) hardware, which can be updated only at a whole minute. During the interval, while waiting for the update to take effect, some user actions such as keyboard inputs may cause unexpected results (e.g., a FAIL-TO-SYNC).

For GMT updates > 15 msec:

No user actions or keyboard inputs should be attempted until the update takes effect. This type of update will force reinitialization.

For GMT updates  $\leq$  15 msec:

Do not perform the following actions until the update takes effect:

- Addition of a GPC to the CS
- OPS transition request or mode recall
- I/O reset
- I/O terminate switch change
- Accumulator select (DR 29284/DR 40620)

**(3) (4C)** MTU Updates with FC Strings not in RS. If an MTU update or accumulator sync is performed with Flight Critical Strings 1, 2, or 3 split between redundant set and nonredundant set GPCs, it is possible to have two computers issuing an MTU update. The effects on the MTU are unpredictable.

			1	2	(1)	3	4	5	
			1 2 3 4 5 6 7 8 9 0 1 2 3 4 5 6 7 8 9 0 1	1 2 3 4 5 6 7 8 9 0 1 2 3 4 5 6 7 8 9 0 1	1 2 3 4 5 6 7 8 9 0 1 2 3 4 5 6 7 8 9 0 1	1 2 3 4 5 6 7 8 9 0 1 2 3 4 5 6 7 8 9 0 1	1 2 3 4 5 6 7 8 9 0 1 2 3 4 5 6 7 8 9 0 1	1 2 3 4 5 6 7 8 9 0 1	
1	XXXX / XXX / 006			GPC / BUS STATUS			XX	X	DDD / HH : MM : SS
(2) 2							DDD / HH : MM : SS		
3		→ GPC	1 S	2 S	3 S	4 S	5 S		
(3) 4		→ MODE	XXXX	XXXX	XXXX	XXXX	XXXX		
5		→ OPS	XX	XX	XX	XX	XX		
6		→ STRING	1 FF	XS	XS	XS	XS	XS	
(4) 7			FA	XS	XS	XS	XS	XS	
8		2 FF	XS	XS	XS	XS	XS		
9		FA	XS	XS	XS	XS	XS		
10		3 FF	XS	XS	XS	XS	XS		
1		FA	XS	XS	XS	XS	XS		
2		4 FF	XS	XS	XS	XS	XS		
3		FA	XS	XS	XS	XS	XS		
4									
5		PL 1	XS	XS	XS	XS	XS		
6		2	XS	XS	XS	XS	XS		
7		LAUNCH 1	XS	XS	XS	XS	XS		
8		2	XS	XS	XS	XS	XS		
9		CRT 1	XS	XS	XS	XS	XS		
20		2	XS	XS	XS	XS	XS		
1		3	XS	XS	XS	XS	XS		
2		4	XS	XS	XS	XS	XS		
3									
4									
5								( X X )	
6									

- (1) GPC/BUS STATUS display is a system level display (DISP 6) available in all OPS providing the primary means for monitoring the GPC and data bus configuration and status.
- (2) GPC. The configuration and status of a GPC are defined in the column below that GPC number. A failed GPC is indicated by a '↓'.

NOTE: The '↓' is derived from GPC FAIL votes. An item 48 on SPEC 0 may result in the removal of this down arrow for a failed GPC.

- (3) MODE/OPS. The MODE switch status for each GPC (i.e., HALT or RUN) is displayed.

OPS indicates resident major functions and active OPS for each GPC. The major function is indicated by G, S, or P for GNC, SM, or PL, respectively. The second character is the OPS number. When a GPC is in HALT or STBY, the last active OPS (non OPS 0) is displayed.

- (4)\* STRING. The I/O configuration/status for each bus (string 1 thru 4 (FF and FA), PL, LAUNCH, and CRT) is displayed.

An '\*' is displayed in the column of the GPC currently commanding a bus. FF and FA, and PL 1 and 2 are commanded as a pair. A failed or masked bus is indicated by a '↓'.

NOTE: The bus status data displayed on SPEC 6 may be misleading. The data displayed in each column (per GPC) represents the most recent information received (via ICC) by the GPC driving the display. Information for any GPC that has failed out of the common set will be stale and may be invalid. This data is only valid for those GPCs remaining in the common set with the GPC driving the SPEC 6 display.

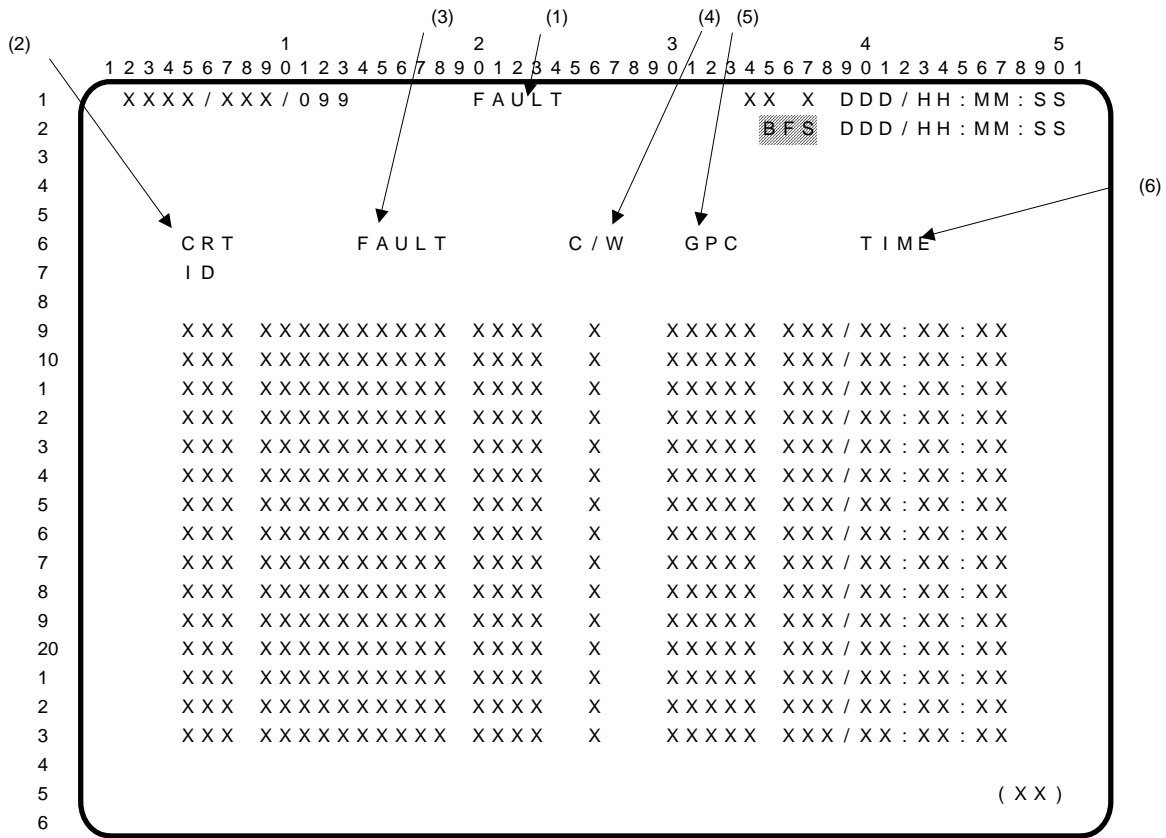

Note:   indicates parameters are driven and displayed on the BFS displays only.

- (1) FAULT display. A system level display available in all OPS sequences. Includes up to 15 (20 for BFS) summary messages of faults (alerts or Caution and Warning (C/W)) which have occurred. The messages are ordered so that the latest fault is at the top of the page. The display is called via a dedicated key (FAULT SUMM). If the display is called via SPEC 099 PRO, the messages are cleared.
- (2) CRT ID. A three-character field identifying the Cathode Ray Tube (CRT) page on which the fault is displayed. The first character represents the major function (G for Guidance, Navigation, and Control (GNC), S for Systems Management (SM), P for Payload (PL)), and the last two digits are the display number. However, the CRT Identification (ID) is not included in messages that are not referenced to a CRT display page.
- (3) FAULT. Text identifying the system experiencing the fault.
- (4) C/W. Used only with C/W messages. The field displays an indicator (\*) if a lower or an upper limit was exceeded.
- (5) GPC. Identification of the General Purpose Computer (GPC) which detected and identified the fault. The BFS display has a single column for indicating the BFS GPC identification.
- (6) TIME. The mission time (in day/hr:min:sec) at which the fault was annunciated.

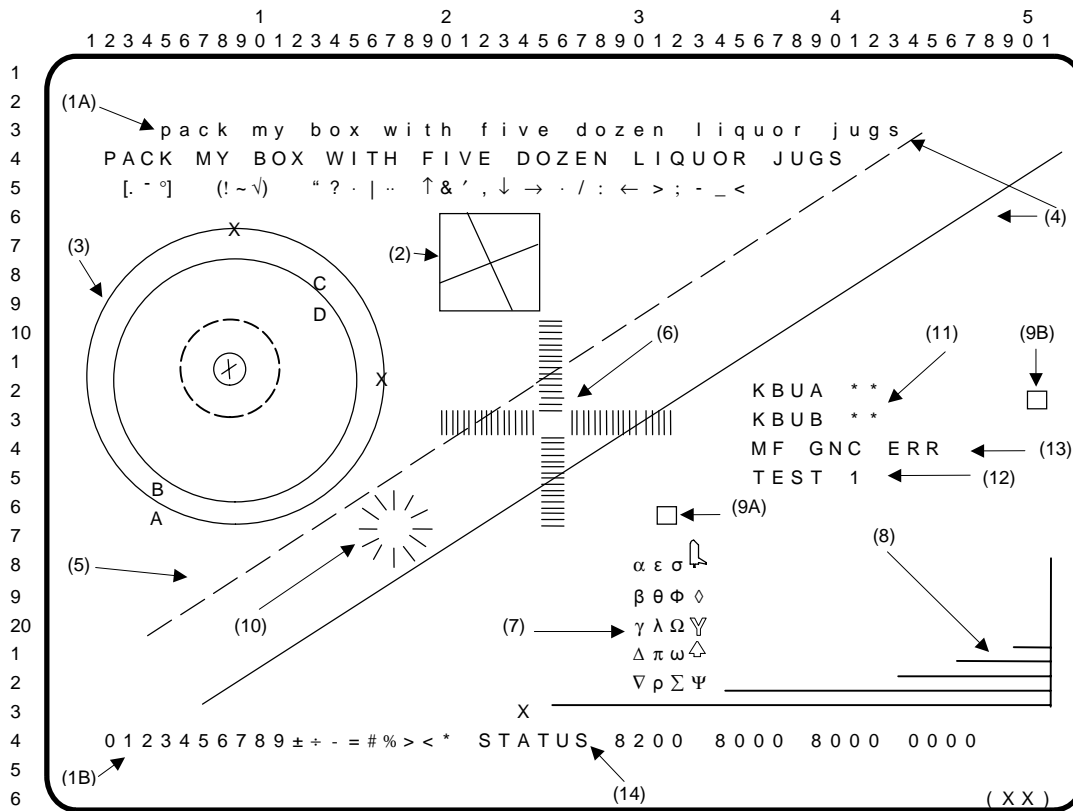

The display for the DEU Stand-Alone Self-Test is nonstandard, and this test is run independently of other functions. The only contact with the GPC is polling, so that the test may be terminated. The display does not include OPS, SPEC, or DISP page numbers. It does not include the standard title line, the GPC indicator, the mission elapsed time, the event timer, the tutorial line, the fault line, or the scratch-pad line. It cannot be overlain. This display is invoked via the IPL MENU display and is available only during a GPC IPL.

**(1)** DEU symbol elements.

**(1A)** The first line displays lower case Roman letters; the second line displays upper case Roman letters; and the third line displays characters, all in normal size and intensity.

**(1B)** Numerals are displayed in normal size and intensity. Mathematical symbols are displayed at bright intensity and normal size.

**(2)** A square with sides 0.7383 inch in length, oriented horizontally and vertically and drawn with normal intensity. Within the square is a dynamic display of rotating vectors.

**(3)** Display of four concentric circles in normal intensity. Three are drawn in solid lines and one is drawn with dashed lines. A capital letter X, at normal intensity, is written so its center coincides with the largest circle at the top (0°). Another such capital X is on the largest circle at the right side (90°). Within the arrangement of circles is a dynamic display of rotating and revolving letters.

**(4)** Two parallel lines run diagonally across the screen from the lower left corner to the upper right corner. Both lines are of normal intensity; the upper line is dashed, and the lower line is solid.

**(5)** An area that should be blank unless the blanking feature is malfunctioning. If the letter writing is working, but the blanking is not, the following legend appears in this area: 'BLK FAIL'.

**(6)** An array of tick marks for checking focus and resolution. The tick marks are short, straight line segments from the symbol generator character matrix.

**(7)** Four-by-five array of upper and lowercase Greek letters, del (upside down capital delta), Tacan symbol (an outline Y with all three arms of equal length and angle), diamond, and plan and elevation outlines of the space shuttle.



DEU STAND-ALONE SELF-TEST (Cont):

- (8) An array of horizontal lines of varying brightness. There are ten horizontal lines spaced vertically equidistant, and the right ends are vertically aligned and connected with a vertical line. The five shortest of these ten lines are displayed at normal intensity and flashing. The five longest of these ten lines are displayed with continuously varying intensity from zero to maximum and continuously varying back to zero.
- (9) **(9A)** A small square (from the symbol generator character matrix) which travels continuously back and forth in a horizontal line (between the center and the right edge of the screen). The square is displayed in normal intensity and travels back and forth, a complete cycle requiring approximately 18.62 seconds.
- (9B)** A similar vertically moving square. This square is displayed in normal intensity and travels up and down, a complete cycle requiring approximately 4.63 seconds. Every fourth cycle, this square coincides at the bottom of its travel with the horizontally moving square at its rightmost position.
- (10) A spinning 'bug' consisting of 16 lines in a sunburst array, rotating about a center which moves up and to the right. The pattern does not appear to be a rolling wheel, but rather an emblem at the center of a rolling wheel, with about four times the diameter. Immediately following the upward transit, the bug reverses direction and appears to roll and slide down the hill at the same rate it moved up. Then it starts up again. The complete cycle takes approximately 26.48 seconds.
- (11) Text block containing the legend 'KBUA' followed initially by two '\*'s and 'KBUB' followed initially by two '\*'s. These lines are for checking operation of the keyboard associated with the display. If the display is on the center CRT, one line is used for each of the two keyboards that may be connected to the CRT. The keys are coded from 00 thru 31, from left to right and top to bottom. As any key is depressed, its number appears on the display and remains until another key is depressed. This display of the codes goes on right along with key sequences that activate the status test.
- On the next line an encoding of the position of the major function switch is shown to the right of the letters MF as 'GNC' or 'SM'. The position of the major function switch may be changed for testing purposes.
- (12) Activation of the BITE test and an asterisk indication of when it is in progress. The BITE test is activated by entering the key sequence: ITEM 1 EXEC.
- (13) To terminate the DEU stand-alone self-test display, the major function switch must be in the same position it was in when the self-test was initiated while the RESUME key is entered. If the major function switch is not set properly, the word 'ERR' appears beside the major function indicator on the display and flashes. 'ERR' remains flashing until a key is depressed on the keyboard or until the position of the major function switch is changed; then the error message disappears.
- (14) The word 'STATUS' appears, followed by a pattern of four groups of four hexadecimal digits indicating the status of the BITE register. The digits are initially blank while the condition of the DEU is being assessed by the program. The status is then displayed. The normal display is: 8200 8000 8000 0000. If the DEU has just been reloaded, for such reasons as initial startup or a power transient, the last group of four digits, instead of being 0000, will be 2000.

1 2 3 4 5 6 7 8 9 0 1 2 3 4 5 6 7 8 9 0 1 2 3 4 5 6 7 8 9 0 1 2 3 4 5 6 7 8 9 0 1

(1) (3) (2)

```

1 XXXX IPL MENU (1) X DDD/HH:MM:SS
2 PASS1 1X PASS5 9X DDD/HH:MM:SS
(4) 3 BFS1 2X BFS5 10X STP/PURGE CYC CNT XXXXX ←(8)
4 PASS2 3X PASS6 11X ERROR/MSG CODE XXX
5 BFS2 4X BFS6 12X ERROR/MSG CODE CNT XXXX
6 PASS3 5X PASS7 13X TOTAL ERR/MSG CNT XXXX
7 BFS3 6X BFS7 14X MSGS STILL IN LIST XXX
8 PASS4 7X PASS8 15X
9 BFS4 8X BFS8 16X
(5) 10 MCDS BITE
17 DEU FORMAT LOAD X MODE XXXX ←(9)
2 BSR1 XXXX
(6) 3 START GPC SELF TEST 18X BSR2 XXXX
4 STOP GPC SELF TEST 19X SWSW XXXX
5 START DEU SELF TEST 20X
6
7
8
9
20 STOP STP ON ERROR 24X
(7) 1 CONTINUE STP ON ERR 25X START 28X
2 INHIBIT CKPT LOAD 26X STOP 29X
(11) 3
4
5
6 (XX)

```

XXXXXXXXXXXXXXXXXX

27 OPTION X

(5) (1) (3) (2)

1 2 3 4 5 6 7 8 9 0 1 2 3 4 5 6 7 8 9 0 1 2 3 4 5 6 7 8 9 0 1

```

1 GPC IPL MENU (2) X DDD/HH:MM:SS
2 DDD/HH:MM:SS
3 17 DEU FORMAT LOAD X STP/PURGE CYC CNT XXXXX ←(8)
4 START GPC SELF TEST 18X ERROR/MSG CODE XXX
(6) 5 STOP GPC SELF TEST 19X ERROR/MSG/CODE CNT XXXX
7 START DEU SELF TEST 20X TOTAL ERR/MSG CNT XXXX
(7) 8 STOP STP ON ERROR 24X MSGS STILL IN LIST XXX
9 CONTINUE STP ON ERR 25X
(11) 10 INHIBIT CKPT LOAD 26X
1 MCDS BITE
2 BSR1 XXXX ←(9)
3 BSR2 XXXX
4 SWSW XXXX
5
(10) 6 OLD PSW XXXX XXXX XXXX XXXX
REGISTER 0-3 XXXXXXXX XXXXXXXX XXXXXXXX XXXXXXXX
7 SET 0 4-7 XXXXXXXX XXXXXXXX XXXXXXXX XXXXXXXX
8
9 REGISTER 0-3 XXXXXXXX XXXXXXXX XXXXXXXX XXXXXXXX
20 SET 1 4-7 XXXXXXXX XXXXXXXX XXXXXXXX XXXXXXXX
1
2 FLOATING 0-3 XXXXXXXX XXXXXXXX XXXXXXXX XXXXXXXX
3 PT REGS 4-7 XXXXXXXX XXXXXXXX XXXXXXXX XXXXXXXX
4 MAJ=XXXXX MIN=XX SCHEDWRD=XXXXXXXXX CLOCK1=XXXXX
5 (XX)
6

```

## XXXXIPL MENU Display Description

The Initial Program Load (IPL) MENU display provides access to the GPC Self-Test Program (STP) function and the Real Time Processor (RTP) function of the GPC IPL program during self-test operation and the means to control and monitor memory purge operations for the DEU, MMU, and/or GPC.

- (1) The display consists of two pages. The title for page one is partially dynamic. During execution of the GPC IPL program, the title will be GPC IPL MENU (1). If the control should be passed to the Backup System Loader (BSL), the title will read BSL2IPL MENU (1). Page two is displayed only while GPC IPL is executing. It provides additional self-test information and is accessed via the SYS SUMM key.
- (2) IPL elapsed time is maintained on the upper time readout and is started at GPC IPL initialization. The lower time display is not initialized and is set to zero.
- (3) The GPC driving the display is indicated.
- (4) Items 1 thru 16 allow selection of the software to be loaded into the GPC following STP execution. Nominally, item 1 or 2 will be used.
- (5) Item 17 provides the capability of loading the DEU with a selected format load.
- (6) GPC and DEU Self-Test initiation command capability is provided via items 18 thru 20. DEU Self-Test is terminated by depressing the RESUME key or by positioning the DEU initialization switch to LOAD, then releasing.
- (7) Items 24 and 25 provide self-test controls which are valid only when the STP (item 18) has been initiated. Item 24 causes the self-test to halt at the first error. Item 25 allows the self-test to continue despite errors, until 99 errors have been logged.
- (8) Data provided during GPC IPL include: (1) the number of complete cycles through GPC self-test or memory purge operations; (2) the latest error code to be encountered; (3) the number of times the error code has occurred; (4) the total number of errors that have occurred; and (5) the number of errors yet to be viewed.
- (9) BITE status information is provided for the MCDS (DEU).
- (10) On page two (GPC IPL MENU (2)) the contents of the program status word, register sets 0 and 1, and the floating point register set are displayed for each error encountered. The major cycle count, minor cycle count, minor cycle scheduler word, and clock 1 value, which correspond to the currently displayed ERROR CODE, are also displayed.
- (11) Item 26 inhibits the loading of IMU checkpoint data from mass memory into the BF GPC.
- (12) Memory purge control is provided by items 27, 28, and 29. Item 27 selects the purge option (1 thru 8) which is then started by item 28. Item 29 may be used to stop any option in progress except during the final phase of option 8. The title is 'MEMORY PURGE' when an option is not selected and 'DEU ERASE', 'MMU 1/2 OVERWRITE/ERASE/CHECKSUM', or 'GPC ERASE' when option 1 thru 8 is selected.

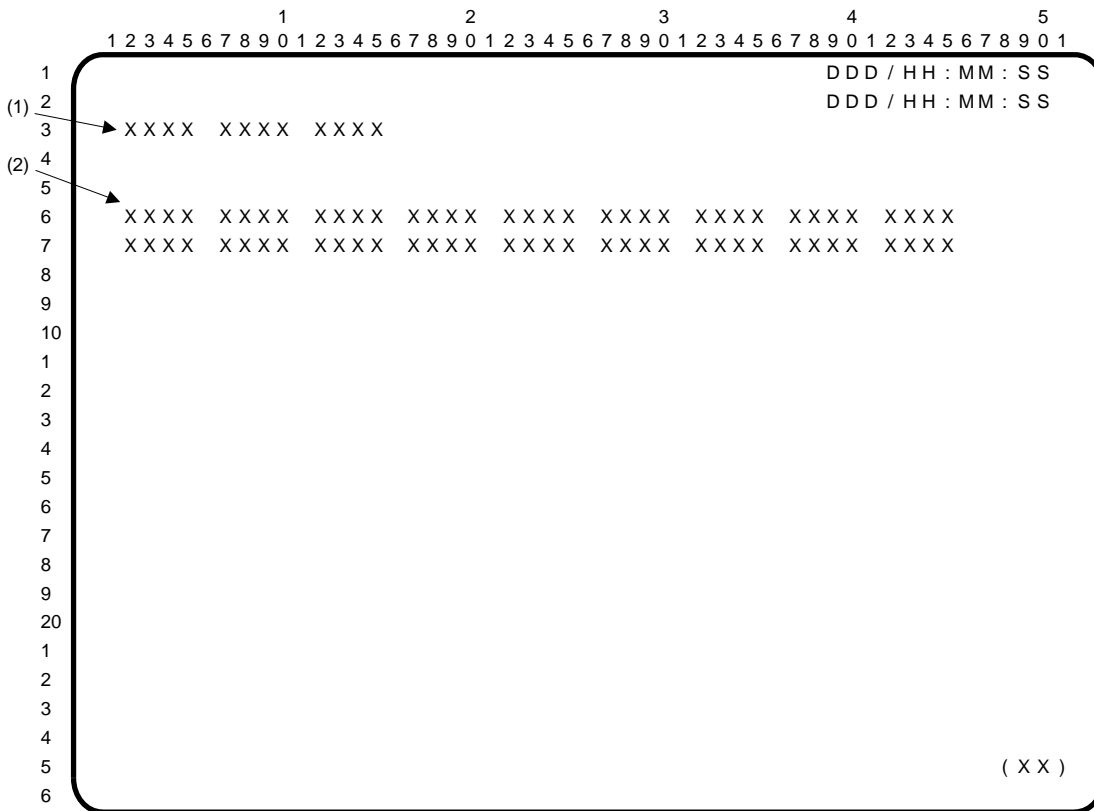

The Operational Test Program (OTP) provides the capability to test/troubleshoot the Display Electronic Unit (DEU) hardware and software. The testing does not require a GPC interface with the DEU and is available whenever the DEU Control Program (DCP) is in control (i.e., anytime after a successful DEU IPL).

Control of the OTP is available through the following keystroke sequences:

ITEM A EXEC – Initializes the DEU. This command acts in the same manner as cycling the DEU power switch.

ITEM B EXEC – Displays the hardware BITE STATUS word 1, hardware BITE STATUS word 2, and software BITE STATUS word (see **(1)**). Nominal values are 8200, 8000, and 0000, respectively.

ITEM C EXEC – Clears the BITE registers. Functional only when the DEU is not being polled by a GPC.

ITEM D + X X X X EXEC – Displays the contents of any DEU memory location or DCP buffer on the CRT (see **(2)**). The address of the location desired must be entered as four hexadecimal digits in the X X X X field. The first four-digit field on each line shows the starting address for that line. The following eight fields give the contents of eight memory locations starting with the given address.

ITEM E EXEC – Exits the OTP and restores the CRT to whatever display page was being shown when OTP was initiated.

ITEM F + X X EXEC – Displays one of up to 30 display backgrounds or skeletons stored in the DEU Critical Format Buffer. A two-digit integer input is required in the X X field (see Critical Format Table on following page). The stored display background format will be driven onto the CRT.

- (1)** DEU BITE STATUS WORDS – Display associated with ITEM B EXEC keyboard entry. First four-digit field is hardware BITE STATUS word 1; second field is hardware BITE STATUS word 2; third field is software BITE STATUS word.
- (2)** DEU MEMORY DISPLAY – Display associated with ITEM D + X X X X EXEC keyboard entry.

XX	Critical Format
1	FAULT
2	HORIZ SIT
3	VERT SIT
4	XXXXX MNVR YYYYY
5	ASCENT TRAJ/RTLS TRAJ
6	GNC SYS SUMM 1
7	ENTRY TRAJ
8	GPC MEMORY
9-11	SPARE
12	S TRK/COAS CNTL
13	IMU ALIGN
14	OVERRIDE
15	CONT ABORT
16	RCS
17-30	SPARE

This Page Intentionally Blank

# GNC CRT DISPLAYS

	<u>PAGE</u>
<u>OPS G1 (ASCENT)</u> .....	3-3
OPS 1011 XXXXXX TRAJ .....	3-4
OPS 1041 XXXXX MNVR YYYYY .....	3-7
DISP 18 GNC SYS SUMM 1 .....	(SEE GNC, OPS G2, PAGE 3-22)
SPEC 23 RCS .....	(SEE GNC, OPS G2, PAGE 3-35)
SPEC 50 HORIZ SIT .....	(SEE GNC, OPS G3, PAGE 3-68)
SPEC 51 OVERRIDE .....	3-12
SPEC 53 CONTROLS .....	(SEE GNC, OPS G3, PAGE 3-75)
<u>OPS G2 (ORBIT)</u> .....	3-17
OPS 2011 UNIV PTG .....	3-18
OPS 2021 XXXXX MNVR YYYYY .....	(SEE GNC, OPS G1, PAGE 3-7)
DISP 18 GNC SYS SUMM 1 .....	3-22
DISP 19 GNC SYS SUMM 2 .....	3-24
SPEC 20 DAP CONFIG .....	3-26
SPEC 21 IMU ALIGN .....	3-30
SPEC 22 S TRK/COAS CNTL .....	3-33
SPEC 23 RCS .....	3-35
SPEC 25 RM ORBIT .....	3-39
SPEC 33 REL NAV .....	3-41
SPEC 34 ORBIT TGT .....	3-46
SPEC 55 GPS STATUS .....	3-49
<u>OPS G3 (ENTRY)</u> .....	3-59
OPS 3011 XXXXX MNVR YYYYY .....	(SEE GNC, OPS G1, PAGE 3-7)
OPS 3041 ENTRY TRAJ 1 .....	3-60
OPS 3041           2 .....	3-62
OPS 3041           3 .....	3-62
OPS 3041           4 .....	3-63
OPS 3041           5 .....	3-63
OPS 3051 VERT SIT 1 .....	3-64
OPS 3051           2 .....	3-67
DISP 18 GNC SYS SUMM 1 .....	(SEE GNC, OPS G2, PAGE 3-22)
SPEC 21 IMU ALIGN .....	(SEE GNC, OPS G2, PAGE 3-30)
SPEC 22 S TRK/COAS CNTL .....	(SEE GNC, OPS G2, PAGE 3-33)
SPEC 23 RCS .....	(SEE GNC, OPS G2, PAGE 3-35)
SPEC 50 HORIZ SIT .....	3-68
SPEC 51 OVERRIDE .....	(SEE GNC, OPS G1, PAGE 3-12)
SPEC 53 CONTROLS .....	3-75
SPEC 55 GPS STATUS .....	(SEE GNC, OPS G2, PAGE 3-49)
<u>OPS G6 (ABORTS)</u> .....	3-77
OPS 6011 XXXXXX TRAJ .....	(SEE GNC, OPS G1, PAGE 3-4)
OPS 6021 VERT SIT 1 .....	(SEE GNC, OPS G3, PAGE 3-64)
OPS 6031 VERT SIT 2 .....	(SEE GNC, OPS G3, PAGE 3-67)
DISP 18 GNC SYS SUMM 1 .....	(SEE GNC, OPS G2, PAGE 3-22)
SPEC 23 RCS .....	(SEE GNC, OPS G2, PAGE 3-35)
SPEC 50 HORIZ SIT .....	(SEE GNC, OPS G3, PAGE 3-68)
SPEC 51 OVERRIDE .....	(SEE GNC, OPS G1, PAGE 3-12)
SPEC 53 CONTROLS .....	(SEE GNC, OPS G3, PAGE 3-75)
<u>OPS G8 (ON-ORBIT VEHICLE UTILITY)</u> .....	3-79
OPS 8011 FCS/DED DIS C/O .....	3-80
DISP 18 GNC SYS SUMM 1 .....	(SEE GNC, OPS G2, PAGE 3-22)
DISP 19 GNC SYS SUMM 2 .....	(SEE GNC, OPS G2, PAGE 3-24)
SPEC 23 RCS .....	(SEE GNC, OPS G2, PAGE 3-35)
SPEC 40 SENSOR TEST .....	3-82
SPEC 41 RGA/ADTA/RCS .....	3-83
SPEC 42 SWITCH/SURF .....	3-84
SPEC 43 CONTROLLERS .....	3-86
SPEC 44 SWITCHES .....	3-88

GNC

OPS G8 (ON-ORBIT VEHICLE UTILITY) (Cont)

SPEC 45 NWS CHECK ..... 3-89  
SPEC 55 GPS STATUS .....(SEE GNC, OPS G2, PAGE 3-49)

OPS G9 (PREFLIGHT VEHICLE UTILITY)..... 3-91

OPS 9011 GPC MEMORY ..... (SEE SYS S/W, PAGE 2-2)  
SPEC 55 GPS STATUS .....(SEE GNC, OPS G2, PAGE 3-49)  
SPEC 100 GTS DISPLAY..... 3-92  
SPEC 101 SENSOR SELF-TEST ..... 3-94  
SPEC 102 RCS/RGA/ADTA TEST ..... 3-95  
SPEC 104 GND IMU CNTL/MON..... 3-97  
SPEC 105 TCS CONTROL ..... 3-99  
DISP 106 MANUAL CONTROLS ..... 3-101  
SPEC 112 GPC/BTU I/F ..... 3-102  
SPEC 113 ACTUATOR CONTROL ..... 3-104



OPS G1 (ASCENT)

OPS G1  
(ASCENT)

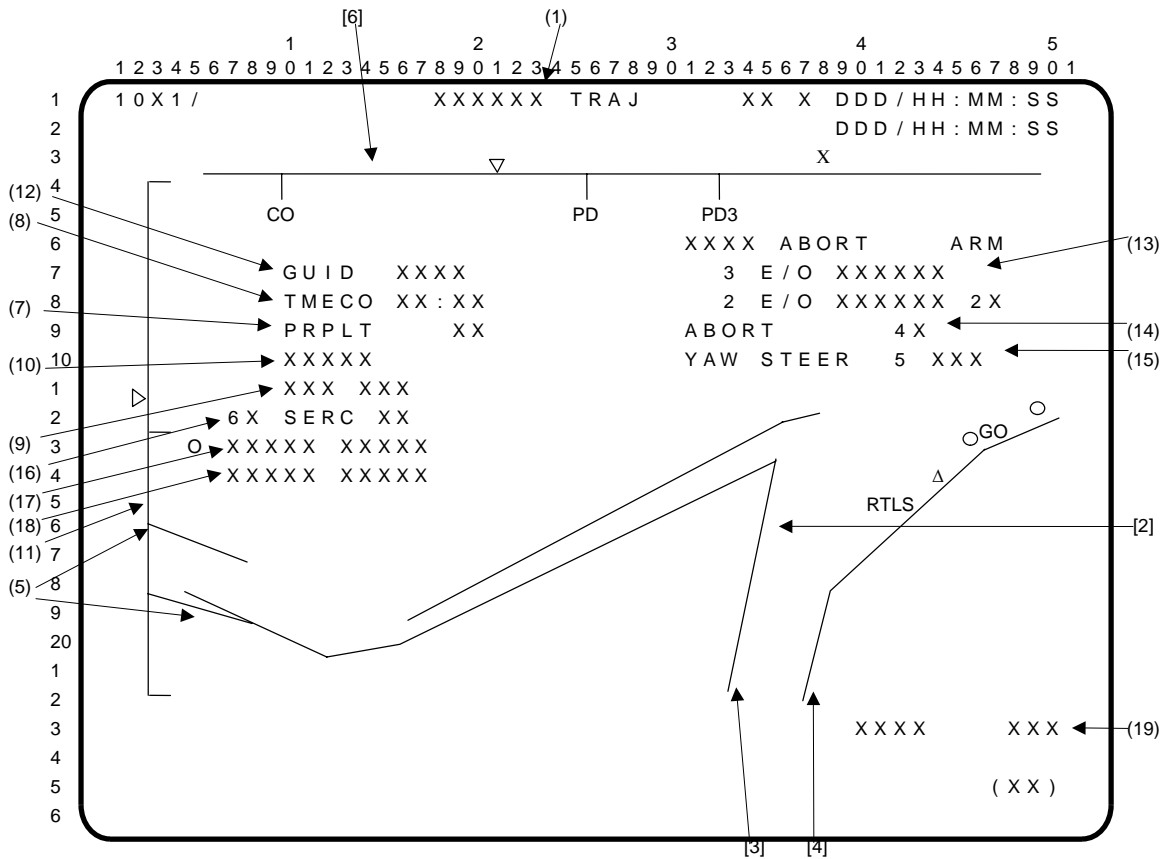

Note: [ ] denotes trajectory dependent data.

**(1)** The XXXXXX TRAJ title of this display is dynamic. It is LAUNCH TRAJ in MM101. In MM102 and MM103, it is ASCENT TRAJ unless abort is initiated. At TAL, ATO, or RTLS initiations, it indicates the abort mode selected. In MM601, the title is RTLS TRAJ. This display provides the crew with trajectory information following the SSME START command and normally stays up until crew selection of a transition to OMS 1 insertion major mode. During the powered flight portion of RTLS phase, the display stays up until ET separation.

This display allows the crew to monitor the automated contingency abort mode processing for two and three main engine out failure scenarios. This display also provides the crew with manual control to invoke the two engine out contingency abort. The snapshot inertial velocity at the time of first SSME failure confirmation is displayed. In addition, this display allows the crew to manually initiate or terminate single engine roll control as well as enable or inhibit contingency yaw steering.

**[2]** The central plot is an altitude vs. horizontal component of relative velocity profile from a last time abort. Current vehicle state is indicated by a moving triangle with the predicted state for 30 and 60 sec in the future indicated by circles.

**[3]** This segment of the altitude vs. velocity line is for an engine out at lift-off RTLS abort.

**[4]** This line represents the nominal ascent profile. An abort after staging would originate on this line but loft somewhat above it as the abort progressed. Abort regions are indicated along the plot as RTLS and GO.

**(5)** The  $\bar{q} = 2$  and  $\bar{q} = 10$  lines are the altitude vs. velocity lines; if the vehicle state is below the line,  $\bar{q}$  will be greater than 2 and 10 PSF, respectively.  $\bar{q} = 2$  and  $\bar{q} = 10$  PSF are ET separation constraints.

**[6]** The scale across the top is delta range ( $\Delta R$ ).  $\Delta R$  is defined as glide range potential based on energy state minus present range from the landing site in nautical miles. Present  $\Delta R$  is indicated by a moving triangle. A tick mark is placed on the scale where powered pitch down (PD) nominally occurs at MECO - 20 seconds, and a second tick is placed where PD occurs for the three-engine RTLS case. During RTLS, a flashing 'F' is displayed (at X, above the scale) when guidance enters the fine countdown mode (6 seconds before PD), then is turned off when PD begins.

XXXXXX TRAJ (Cont):

- (7) PRPLT is a digital readout of present propellant remaining in the external tank in percent.
- (8) TMECO is the predicted time of MECO, in minutes and seconds, from lift-off. This field will blank whenever a contingency abort is initiated except for a contingency Abort Mode 5 (RTLS RED – single engine RTLS completion).
- (9) 'SEP INH' is displayed in MM102 if the SRB AUTO separation is inhibited and is blanked upon transitioning to MM103. 'SEP INH' is also displayed in MM103 if ET AUTO separation is inhibited.
- (10) 'PC < 50' is displayed if the SRB Chamber Pressure drops below 50 psi.
- (11) The scale on the left is  $\Delta\dot{H}$ , which is navigation  $\dot{H}$  minus a reference  $\dot{H}$  (which is a function of  $\Delta R$ ). Present  $\Delta H$  is indicated by a moving, oversize, overbright triangle which flashes if off-scale.
- (12) GUID indicates the status of the guidance solution prior to a powered pitcharound. Prior to RTLS selection (MM601), this field is blanked. Once RTLS is selected, GUID INIT will be displayed until initialization is complete. As the vehicle progresses to the powered pitcharound point, GUID displays the percent deviation of the predicted final mass from the RTLS mass target. GUID INHB will be displayed if the powered pitcharound has been delayed due to an attitude violation or if guidance is unconverged. Once the powered pitcharound begins, GUID PPA will appear, and the field will be frozen.
- (13) 'CONT' or 'RTLS' is displayed depending on the type of abort. The text will initially display 'CONT' on transition to MM101.

A color word is displayed describing the contingency abort mode region for the three engine out (3 E/O) failure scenario. The text will initially display 'BLUE' on transition to MM101 and update cyclically. There are two different ways of updating the 3 E/O color word depending on whether or not the three engine out auto contingency logic is disabled pre-flight (via I-load). If the auto logic is enabled, the displayed color word is based on trajectory parameters such as dynamic pressure, angle of attack, and altitude rate to determine the optimum ET sep maneuver for the given conditions. The color word will either be blank, blue, green, orange, yellow, or red (Note: the 3 E/O red region can only be entered from a 3 E/O yellow contingency abort). A blank color word indicates that a three engine out contingency abort is not required for the loss of all three main engines. If MECO confirmed is set when the color region is not blank, the 3 E/O color word will be displayed double overbright to indicate the automatic maneuver is actually being performed.

A color word (blank, blue, yellow, orange, green, or red) is displayed describing the two engine out (2 E/O) failure scenario. The text will initially display 'BLUE' on transition to MM101.

- (14) Item 4 (ABORT) allows the crew to invoke the automated contingency abort as indicated by the 2 E/O abort mode region color word which is displayed double overbright when armed via item 2. An '\*' indicates selection of item 4; item 4 is initialized blank in MM101. Attempting to execute item 4 before item 2 has been selected will result in an 'ILLEGAL ENTRY' message.

Guidance will automatically initiate a single engine RTLS completion contingency abort mode (RTLS RED) if two SSMEs are confirmed failed and the 2 E/O abort mode color word is 'RED'.

Once items 2 and 4 have been correctly executed (either manual or auto), any further attempts to execute items 2, 4, or 5 will result in an 'ILLEGAL ENTRY' message.

NOTE: Once item 2 is executed, the software is locked into the displayed abort region. If a significant delay transpires between executing item 2 and item 4, the vehicle may transition to another abort region, but the maneuver to be flown will have been frozen in the previous region. The crew should execute items 2 and 4 in close succession.

XXXXXX TRAJ (Cont):

- (15) Item 5 (YAW STEER) allows the crew to enable (ENA)/inhibit (INH) contingency yaw steering. This item is initialized enabled in MM101. Item 5 is legal in MM101, MM102, MM103, and MM601 only; attempting to execute item 5 in any other major mode will result in an 'ILLEGAL ENTRY' message. Also, attempting to execute item 5 once items 2 and 4 have been correctly executed (either manual or auto) will result in an 'ILLEGAL ENTRY' message. Once a contingency abort is declared, the yaw steering option cannot be changed.
- (16) Item 6 (SERC) provides the crew with the capability to manually initiate or terminate single engine roll control. An '\*' next to the item number indicates that the contingency SERC is enabled. (OMS-RCS interconnect begins.) Item 6 is illegal until transition to MM102. 'ON' will be displayed double overbright to the right of SERC when the ENA RCS CNTL discrete is set to on (OMS-RCS interconnect is complete and jets will begin firing as needed for roll control); otherwise, the character string is blanked. When a second main engine failure is confirmed, the crew will not be able to terminate single engine roll control due to Ascent DAP and Abort Control Sequence requirements even though the item entry will be accepted on the display. If a first engine has failed or has had a data path failure, and sensed acceleration drops below a threshold value during second stage, SERC is automatically commanded.
- (17) The inertial velocity after one main engine is confirmed failed is displayed in feet per second below item 6 along with the character string 'EO VI'. These fields are initialized blank in MM101 and remain blank until one of the three main engines fails. The character string and velocity value will continue to be displayed until transition to MM104 and MM602.
- (18) The inertial velocity after a second main engine is confirmed failed is displayed in feet per second below the first EO velocity along with the character string 'EO VI'. These fields are initialized blank in MM101 and remain blank until the second of the three main engines fails. The character string and velocity value will continue to be displayed until transition to MM104 and MM602. The second main engine out velocity and text will be in double overbright.
- (19) The word 'DROOP' and the predicted single-engine droop altitude (in thousands of feet), assuming current thrust, will be displayed in MM103 and blanked at all other times. They will flash if the prediction is below the minimum I-loaded droop altitude and/or be displayed double overbright if the Droop Control Task software is commanding the vehicle's pitch attitude; otherwise they will be displayed at normal intensity without flashing. Also note that if double overbright is on, the low crossrange TAL target has automatically been invoked.

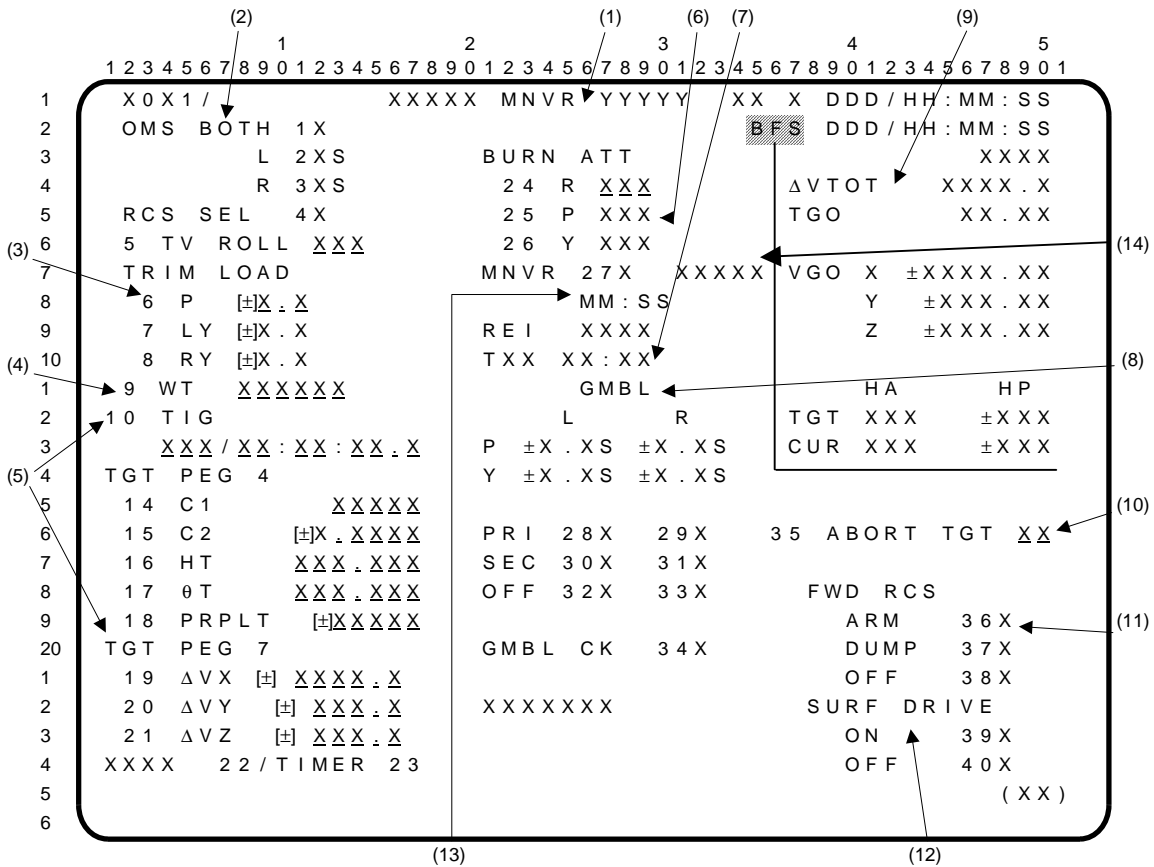

Note:  indicates parameters are driven and displayed on the BFS displays only.

(1) XXXXX MNVR YYYYYY. This GNC display is used in OPS 1, 2, and 3 for insertion, on-orbit, rendezvous, and deorbit maneuvers. It can be used to declare an AOA or ATO abort post MECO or to override automatic target selection in OPS 1 and to burn off forward RCS propellant and provide aerosurface hydraulic fluid thermal conditioning in OPS 3. Display titles are:

<u>OPS 1 MM104</u> OMS 1 MNVR EXEC ATO 1 MNVR EXEC AOA 1 MNVR EXEC	<u>OPS 1 MM105</u> OMS 2 MNVR EXEC ATO 2 MNVR EXEC AOA MNVR TRANS	<u>OPS 1 MM106</u> OMS 2 MNVR COAST ATO 2 MNVR COAST
<u>OPS 2 MM202</u> ORBIT MNVR EXEC	<u>OPS 3 MM301/MM303</u> DEORB MNVR COAST	<u>OPS 3 MM302</u> DEORB MNVR EXEC

(2)\* OMS/RCS SEL/TV ROLL. Items 1 thru 4 provide the engine selection capability for the burn and the associated guidance computations – BOTH for both OMS, L for left OMS, R for right OMS and RCS SEL for +X thrusters. These items are mutually exclusive and the selected option is indicated by an '\*'. When the display is first called up in MM104, BOTH is enabled. Subsequent callups reflect the last option selected and this option is transferred across OPS 1, 2, and 3. Item 22, 'LOAD', must be executed for guidance to recognize a selection. A '↓' is displayed after L and R when predefined chamber pressure and delta velocity limits are exceeded. When OMS RM is running (RM is reset by selecting OMS BOTH), it will remove the '↓' during initialization. For BFS, the '↓' is only driven when OMS chamber pressure is below the I-loaded value. A '↓' is blanked with reselection of the '↓' engine(s).

NOTE: If a bad engine ID is uplinked as part of a target load, the maneuver display will default to RCS +X thrusters in OPS 3 and to an indeterminable selection in OPS 1. A proper engine ID uplink or a crew item number entry will correct this problem. (DR38163U)

Item 5, TV ROLL, the desired local roll angle at ignition, comes from a compool (I-load, uplink, or crew input) and this item is used to update the displayed value (in OPS 2 only). Upon reinitialization of the display, the latest value will be displayed in OPS 1, 2, and 3. This item is not supported by BFS, but the I-loaded or uplinked value is displayed in OPS 1 and 3.

XXXXX MNVR YYYYY (Cont):

- (3)\* TRIM LOAD. Engine gimbal trim angles (in degrees) computed by the DAP are displayed and changed using item 6 – pitch (P) for both OMS and items 7 and 8 – LY, RY for yaw left and yaw right, respectively. Current DAP values are on the display when it is called up. Modification of trim angles requires execution of item 22 (LOAD).
- (4) WT. Item 9 provides the capability to display and change the DAP total orbiter weight (WT) in pounds. This value is calculated the first time the display is called and, if 'LOAD' is not flashing, is updated as current mass is updated. WT can be updated by ground uplink or crew entry but 'LOAD' must be executed for a change to be recognized.
- (5)\* TIG/TGT. Targeting information for guidance is displayed and is changeable by item entries provided in this section. The TIG in mission time (day/hr:min:sec) is always required and must be within 5 minutes in the past and 12 hours in the future. The PEG 4 targeting is done by specifying C1, C2, HT,  $\theta T$ , (OPS 1 and 3), and PRPLT (OPS 3 only) (items 14, 15, 16, 17, and 18) which define the flight path angle coefficients (C1 in fps and C2 a dimensionless value), target radius (HT) in nm, target central angle ( $\theta T$ ), in degrees, and total propellant (PRPLT) in pounds to be used by the deorbit maneuver. The sign on PRPLT defines which side of the orbital plane this quantity of fuel should be wasted. Also, an entry of zero for item 18 when LOAD is not flashing allows the crew to terminate wasting during a deorbit maneuver burn. Whenever PEG 4 targets are entered and LOAD (item 22) executed, the current LVLH components of velocity-to-be-gained ( $\Delta V$ s) shall be displayed and updated in the PEG 7 data fields (items 19 thru 21) (Not supported by BFS).

An external  $\Delta V$  targeting option (PEG 7) is provided by items 19 thru 21. These are the target delta velocities (feet per second) in the LVLH frame at ignition. Targeting inputs can be made by onboard targeting, ground uplink, or item entries. Whenever the display is called, targeting information for a previously executed maneuver will be blanked. Upon input of any PEG 7 target data, the PEG 4 target data fields are blanked. Any data being displayed in the PEG 7 slots will then be replaced with the entered data, and/or the latest previous PEG 7 target data (Not supported by BFS). All targeting inputs are sent to guidance upon execution of LOAD (item 22). After the LOAD item has been executed, any data changed which require the LOAD to be executed for recognition causes the word 'LOAD' to flash. The burn is not enabled until item 22 is executed again and 'LOAD' stops flashing. For the OMS 1 maneuver only, the LOAD is done automatically. Execution of item 23 initiates the CRT event 'TIMER' to count down to the TIG loaded in guidance (except for OMS 1 where the timer starts automatically when MM104 is initiated). If TIG is more than 5 minutes in the past, execution of item 23 causes an error message and the item will be ignored.

NOTE: An attempt to execute LOAD while targeting is still active from a previous command will result in an 'ILLEGAL ENTRY' message.

NOTE: If targeting is active in MM105 or MM302 when a PRO to MM106 or MM303 occurs, target parameters will be displayed on the Coast MM display when they should be blank. In addition, for the MM302 and MM303 case, the I-LOAD entry interface attitude will be overwritten by the targeting attitude and the ADI error needles will reflect this new attitude. Manual entry of the entry interface attitude would resolve this last problem. In general, avoid any major mode transition except 301 to 302 while targeting is still computing burn numbers. (DR 36015)

NOTE: If a transition to MM301 from MM303 occurs just after a state vector update (whole or delta) has been performed, target data entry rejection and CRT timer anomalies may be observed for several seconds while a targeting module finishes execution. When the module completes, item number entry will return to normal and the CRT timer will return to crew control. (DR 36479)

In MM202, the rendezvous guidance option chosen by the ORBIT TARGETING spec is displayed in text. Discrete (1) is set and 'LAMBERT' is displayed for this option. The discrete can be reset (0) by ground uplinking or by crew retargeting to external  $\Delta V$  (via this or the ORBIT TARGETING display) and 'EXT  $\Delta V$ ' will be displayed.

XXXXX MNVR YYYYY (Cont):

- (6)\* BURN ATT/MNVR. Items 24 thru 26 show the roll (R), pitch (P), and yaw (Y) angles (in degrees) in inertial coordinates at ignition computed by guidance for MM104, MM105, MM202, MM301, and MM302 in response to execution of LOAD (item 22). For MM303 an I-load-desired attitude, a ground-uplinked attitude (may be changed in OPS 2, MM301, or MM302), or a crew-entered attitude is displayed. In MM301, MM302 the crew may enter a desired BURN ATTITUDE prior to executions of LOAD or override a guidance-computed one after execution. In the override case, LOAD must be executed again to display the BURN ATTITUDE. BURN ATT R, P, and Y are only enabled for data loading in MM301, MM302, and MM303. The burn attitude stops updating upon MM transition. Item 27 'MNVR' provides for initiation of an automatic maneuver (PASS only) to the desired attitude if DAP AUTO is selected. An '\*' is displayed next to item 27 while the DAP is maneuvering to the pre-burn attitude, and while holding about the pre-burn attitude (OPS 1 and 3 only). If the current attitude is within 8 deg of the desired attitude when item 27 is executed, no '\*' will appear even with DAP AUTO selected; however, the orbiter will move slowly to the desired attitude. In MM202 the ADI error needles are referenced to BURN ATT when item 27 is executed. Execution of item 27 terminates/inhibits the three universal pointing options available via UNIV PTG display in OPS 2. This item is not supported by BFS.
- (7)\* REI/TXX. Orbiter range in nautical miles from 400k feet to the landing site is shown next to REI in OPS 3. Time-to-next-apsis (for OPS 1 and 2) or Time-to-400k feet for OPS 3 is provided, in minutes and seconds, next to TXX. In OPS 1 and 2, time to apogee (TTA) or time to perigee (TTP), whichever is closer, is displayed unless apogee and perigee differ by less than 5 nm. In this case, the title becomes TTC (Time- to-Circularize) and the time field is blanked. During OPS 3, TXX becomes TFF (Time-to-400k feet). In MM303, REI and TFF are recomputed whenever the state vector is updated by uplink or HSD entry. If guidance does not converge following a LOAD, these fields will be zeroed (OPS 3).
- (8)\* GMBL. This selection shows the pitch (P) and yaw (Y) gimbal angles for left (L) and right (R) OMS engines. The status is normally blank but will display a '↓' adjacent to a failed actuator on the selected system or an 'M' for missing data (last valid gimbal data are displayed). Items 28, 30 and 29, 31 allow selection of either primary (PRI) or secondary (SEC) drive systems for the left or right engines, respectively. Items 32 and 33 allow a powerdown of the left or right drive systems. These items are mutually exclusive. An '\*' is displayed by the item number of the system selected. When the display is first called up, primary drive systems are selected unless a different selection was made automatically during ascent. The last selections in OPS 1 are initialized in OPS 2, 3, and 6 when transitioning from OPS 1. Item 34, GMBL CK, allows an automatic TVC check of each active drive system. Display is initialized with item 34 deselected.
- (9)\* BURN DATA. The upper right section of the display contains a dynamic character field where 'EXEC' flashes from TIG -Z seconds (Z is I-loaded, typically 15 seconds) until KYBD EXEC is performed ('EXEC' then disappears), the guidance prediction of the total change in velocity ( $\Delta VTOT$ ) of the targeted maneuver in feet per second, the time to go (TGO) in min:sec (predicted burn time before TIG, or remaining burn time after TIG), the velocity (feet per second) to be gained in body coordinates (VGO X,Y,Z), and the predicted post burn (TGT) and current (CUR) apogee (HA) and perigee (HP) values in nautical miles. KYBD 'EXEC' must be performed after TIG -Z to enable the maneuver to start. In OPS 1 and 3, if guidance does not converge following a LOAD, targeted apogee and targeted perigee will be zeroed, and BURN ATT will be blanked. Also, if a transition is made out of maneuver execute modes MM104, 105, 202, or 302 while a burn is enabled or in progress, the burn will be canceled/terminated.
- (10) ABORT TGT. Item 35 provides a method of selecting an AOA or ATO abort and the target set. It allows an upmode or downmode of the abort desired. It is legal in MM104 and MM105 only, with an ABORT TGT ID of 0 displayed initially in MM104 and entries of 1, 3 thru 5 available thereafter in MM104 and 1 thru 12 in MM105. Any deviation from these TGT IDs in MM104 or MM105, or item 35 execution outside these modes results in an 'ILLEGAL ENTRY' message. Automatically selected IDs from the dedicated abort switch or the OMS 2 target associated with an OMS 1 target set, appear on this display (upon transition to MM105 for the OMS 2 target), but these targets may be overridden by entry of a new target set ID. 'ILLEGAL ENTRY' message results if an ID entry is attempted while an OMS burn is enabled or in progress. If AOA is selected in MM105, 'OPS 301' will flash to indicate when targeting for the AOA OMS 2 burn is complete. The crew can then execute 'OPS 301 PRO'. Manual changes to the targeting data entered in MM105 will be carried across the transition to MM301 without the crew having to perform an item 22 (LOAD).

XXXXX MNVR YYYY (Cont):

- (11) FWD RCS. Items 36 thru 38 provide the capability to initiate, via ARM and DUMP in that order, or terminate burnoff of forward RCS propellants in OPS 3 by executing OFF. An '\*' is displayed by each item number as it is executed. Execution of 'OFF' removes the '\*'s from ARM and DUMP.
- (12) SURF DRIVE. The capability to initiate and terminate a flight control surface drive function is provided by items 39 (ON) and 40 (OFF). This function provides simultaneous motion of all aerosurfaces for hydraulic fluid thermal conditioning in OPS 3 only. An '\*' is displayed next to the selected item number. Display is initialized with item 40 selected and selection of item 39 occurs in MM301. SURF DRIVE remains ON to MM304 when it is auto deselected. Execution of these items in OPS 1 and 2 results in an 'ILLEGAL ENTRY' message.
- (13) TIME-TO-GO. If the DAP is in AUTO and the maneuver to a burn attitude has been initiated with an Item 27, this field will display the amount of Time-to-Go (TTG) to complete the maneuver in the current DAP. This field will be displayed overbright if the pre burn maneuver will not be complete prior to Tig - 30 seconds or (OPS 2 only) if the TTG is greater than 59:59. This field will blank at OMS ignition if the maneuver to burn attitude is not yet complete.
- (14) DAP MODE. The current selected DAP mode (AUTO, FREE, INTRL or LVLH) is displayed in this field. This field will be displayed overbright if Item 27 is executed and the DAP is not in AUTO.

\*PROGRAM NOTES

- (2) Use of BOTH to Clear OMS Down Arrows. If an engine indicates a failure ('↓') during a burn, subsequent to the burn the arrow cannot be cleared by selecting the BOTH item number. The '↓' will be automatically cleared by OMS RM at TIG-15 seconds for a subsequent OMS burn regardless of engine selection. (DR 55314)
- (3) Stale OMS Trim Angle Data. During maneuver operations in MM104 thru MM106, MM202, MM301 thru MM303, the OMS trim angles remain static during and after a burn until the next item entry or display recall. Perform an item entry or display recall to update the OMS trim angles, repeating for each DEU. (DR 39371)
- (5) Timer Countdown Terminated Unconditionally on MM301 Init. or MNVR Target Item Update. Any CRT timer countdown initiated by the crew or the software will be terminated upon entry to MM301 or upon update of a MNVR target item by keyboard or uplink. The crew may reinitiate the countdown using items 22 (LOAD) and 23 (TIMER). (DR 37591)

Guidance Convergence Indications. Subsequent to execution of the LOAD item number, the only positive indication of guidance being unable to converge on a solution will be the display of zeroes for BURN ATT (blank or non-zero when converged) and TGT HA and HP (non-zero when converged). (DR 37573)

Item Entries During RCS BURN. During an RCS maneuver, entries from the KEYBOARD will be accepted by the software. This is the case whether the maneuver was initially planned +4X or whether both OMS engines have failed during the maneuver. If any target set related entry except propellant-to-be-depleted (i.e., trims, engine select, TIG, or targets) is made during the maneuver, target solution values (i.e., TGO, VGOs, burn attitude, etc.) are blanked and a flashing 'LOAD' appears. The same applies for any such target entry prior to burn enable. Do not make target item entries (except for propellant-to-be-depleted) during an RCS maneuver. If an entry is inadvertently made, a new LOAD will be required to reestablish the guidance solution. The TIG for the LOAD must be in the future. Also, the THETA target must be adjusted if TIG is changed (in OPS 3 only) or an REI miss will result. (DR 37564)

Unsupported AOA/ATO Requests in MM105 after OMS 2. If an AOA or ATO abort is requested in MM105 following OMS-2 burn completion:

- A. The AOA/ATO targeting function is not scheduled, so MNVR target items are not automatically updated.
- B. When a crew manually enters a desired MNVR target (item 10-17), followed by the LOAD item, the ATO targeting is correct; however, AOA targeting is incorrect (it should be done in MM301).



- C. For AOA, subsequent transition to MM106 causes the MNVR title to be unreadable in MM106. (DR 45739)

No Flashing 'LOAD' for BFS on Major Mode Transitions. After transitioning from MM104 to MM105, MM104 to MM301, or MM106 to MM301, 'LOAD' will flash on the PASS Maneuver Display but not on the BFS Maneuver Display. Additionally, 'LOAD' will not flash for the BFS OPS 0 to OPS 3 transition, but will flash on the PASS Maneuver Display after the OPS 2 to OPS 3 transition. The flashing 'LOAD' does not appear for the BFS since there are no valid target data to be loaded. It will appear when an uplink or keyboard entry of target data is performed.

For both the PASS and BFS, 'LOAD' must be flashing before item 18 (PRPLT) on the Maneuver Display can be entered with a non-zero value. Because of the flashing 'LOAD' difference between PASS and BFS, a non-zero item 18 could be entered on a PASS keyboard and displayed on the PASS Maneuver Display while being rejected by the BFS without an ILLEGAL ENTRY message. (DR 108559/B20611, 45749)

- (6) No Burn Att for Yaw Near  $\pm 90$  deg. If a PEG 4 or PEG 7 target solution results in a desired preburn yaw attitude near  $\pm 90$  deg, the desired BURN ATT will not be displayed on the MNVR display. This is a display problem only; guidance will still function normally and ADI error needles are still valid. (DR 37585)

Attitude Maneuver to Unknown Attitude. If an auto maneuver is in progress in OPS 2 and item 22 (LOAD) is entered, a new burn attitude will be computed and displayed; the vehicle, however, will continue to maneuver to the old burn attitude. Mode the DAP to any manual mode and back to auto to avoid confusion regarding the attitude to which the vehicle is maneuvering. The crew could also reexecute item 27 with the DAP in auto (once the burn attitude values are displayed) to begin the new maneuver. (DR 48348)

- (7) TFF/REI Blanking. The maneuver display parameters TFF and REI do not get computed for perigee altitudes above 55 nm (an I-load) on any LOAD situation in OPS 3. These parameters are blanked on the display when this occurs; an REI/TIG adjust (as called for in the ASCENT CHECKLIST) is not possible. These parameters may therefore not be computed for AOAs with large MECO underspeeds. (DR 37573)

- (8) Actuator Deselection. If both the primary and secondary actuators are deselected, the P and Y gimbals angles for that engine show a static display of the last valid gimbal data prior to OFF execution (item 32/33). Transition to OPS 3 in this case may result in erroneous gimbal data being displayed. Manually reselecting either primary or secondary gimbals will reinstate dynamic data. (DR 37123)

Gimbal Drive Check. The GMBL CK item can be executed during an OMS burn and will cause the check to be performed, overriding OMS TVC flight control commands. (DR 37561)

- (9) Abnormal OMS Termination/Keyboard Lockout. Multiple failures during an OMS maneuver may lead to control problems and a subsequent guidance divergence requiring manual OMS cutoff. The proper crew response is to terminate OMS thrust with the ARM PRESS SWITCH. The absence of OMS cutoff commands (in the software) causes KEYBOARD lockout.

If TGO stops counting down, the auto system probably will not achieve cutoff and the proper crew response is a manual OMS cutoff.

The chance of a KEYBOARD lockout in this situation should be recognized and, if it results, the procedure for manual setting of the cutoff commands should be used.

In the case of a keyboard lockout, release is effected by an OPS XXX PRO to the next OPS (MM104-MM105, MM302-MM303). Note that MM105-MM106 terminates OMS burn capability in OPS 1 since MM106-MM105 is not permitted.

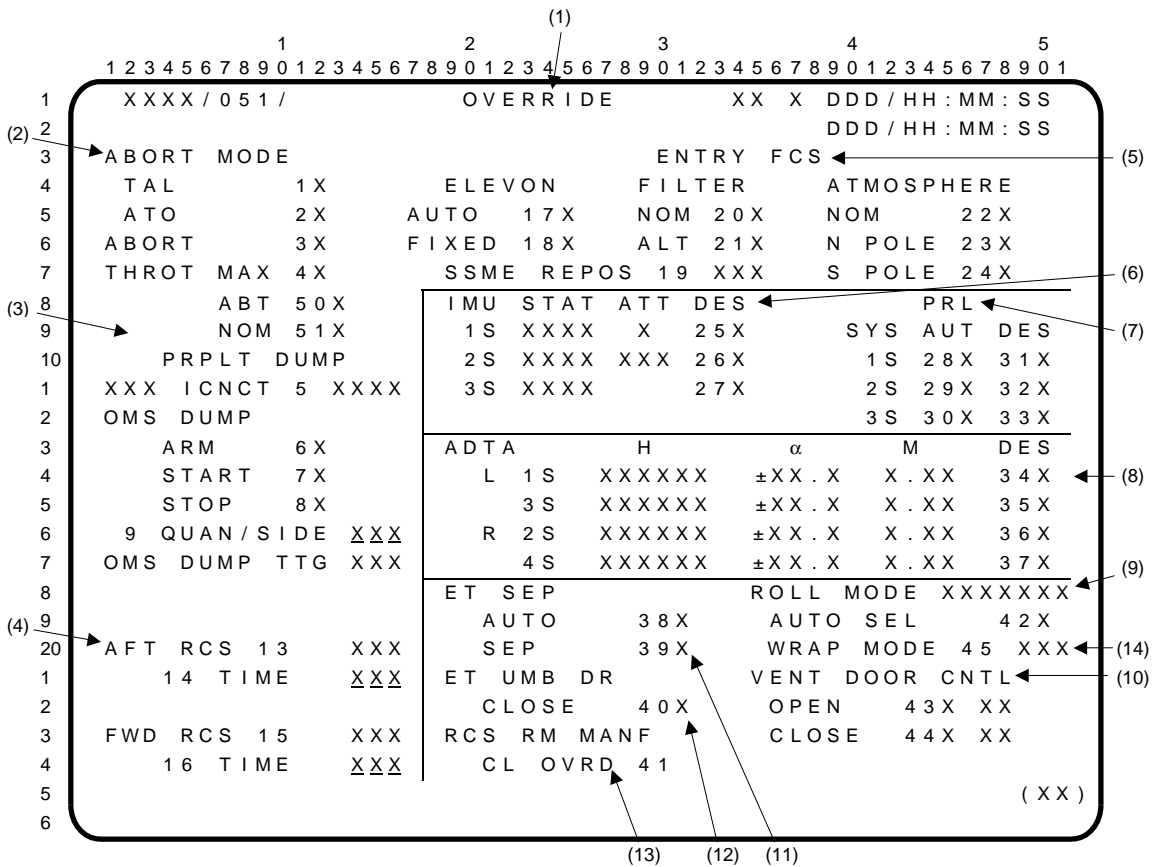

**(1)** **OVERRIDE.** This display is used during OPS 1, 3, and 6 and provides the following capabilities: selection of the desired switch mode for **(2)** ABORT, **(11)** ET SEP, **(12)** ET UMB DR, and **(9)** ENTRY ROLL MODE switches; **(3)** enable/inhibit the OMS/RCS ICNCT function, the OMS dump, the OMS assist burn, and the **(4)** AFT and FWD RCS dumps; **(5)** select the elevon schedule, body bending filter, and the entry atmospheric model in OPS 3 and control the SSME drag chute repositioning sequence; selection/deselection of **(6)** an IMU LRU, **(7)** hydraulic system (PRL), or **(8)** ADTA; **(10)** open/close vent doors during OPS 3 and 6; **(13)** overrides any RCS MANF VLV microswitch dilemma which causes RM to set the MANF VLV status to CLOSED; **(14)** status and control of wraparound FCS mode.

**(2)** **ABORT MODE.** Items 1 and 2 allow the crew to select a TAL abort in MM103 and MM104 or an ATO abort in MM102, MM103, and MM104. These items are mutually exclusive and the selected mode is indicated by an '\*'. The abort sequence is initiated by execution of item 3 and is indicated by an '\*'. Execution of item 3 must be preceded by selection of item 1 or 2. The display is initialized with all three items deselected (no '\*'). Item 4 (THROT MAX), Item 50 (THROT ABT), and Item 51 (THROT NOM), provide the crew with the capability to change the SSME upper throttle level limit to one of three pre-mission I-Loaded throttle limit values and to rescale the SBTC to the new throttle level. Items 4, 50, and 51 are mutually exclusive and the selected throttle limit shall be indicated by driving an asterisk (\*) after the applicable item number. Item 4 is legal only in MM102, MM103, and MM601.

**(3)\*** **PRPLT DUMP.** Items 5 thru 9 allow the crew to enable, inhibit, and control manual or automatic abort dumps in OPS 1, 3, and 6. Item 5 (ICNCT) is used to enable (ENA)/inhibit (INH) the OMS/RCS interconnect function. The interconnect is initialized enabled in OPS 1 and inhibited in OPS 3. If a manual dump is initiated, the status of the OMS/RCS interconnect will be determined by item 5. If item 5 is enabled when an intact abort is selected, item 5 will be set to an I-loaded value by the Abort Control Sequence. If item 5 is inhibited when the abort is selected, item 5 will remain inhibited. Whenever the Abort Control Sequence or OMS/RCS Interconnect Sequence terminates the OMS/RCS interconnect, item 5 will be reset (INH). In MM304/MM602, if the OME\_ONLY\_FLAG is set, attempting to execute item 5 will result in an 'ILLEGAL ENTRY' message, and the item will be rejected. Item 5 does not operate when the Single Engine Roll Control (SERC) flag is set in OPS 1/6. The interconnect is automatically enabled by the Abort Control Sequence. Execution of item 5 at this time will result in an 'ILLEGAL ENTRY' message.

## VERRIDE (Cont):

'CPLT' will be displayed to the right of 'XXX ICNCT 5' when the OMS/RCS interconnect is completed and will return to blank when the return to normal configuration is completed.

Items 6 (ARM) and 7 (START) allow the crew to manually initiate a dump. Item 8 (STOP) inhibits or terminates an automatic dump, or terminates a manual dump. An '\*' indicates selection. The display is initialized with items 6, 7, and 8 reset (no '\*'). Execution of item 6 arms the dump and blanks the STOP \*. Item 7, which can only be executed when item 6 is showing an '\*', starts the dump. Executing item 8 will blank the ARM and START asterisks and stop the dump in progress. Any automatic dumps associated with an abort selection will be inhibited if an '\*' is present next to item 8.

When the crew manually initiates a contingency abort from the XXXXXX TRAJ display, the PROPLT DUMP ARM and START discrettes are set ON, and an '\*' is displayed next to items 6 and 7.

Item 9 (QUAN/SIDE) allows the crew to enter an amount of propellant to be dumped, measured in percent of quantity per side. Item 9 is initialized in OPS 1 to a software calculated quantity based on a manual dump I-load; thereafter, item 9 reflects crew input. If an intact abort is selected, the OMS dump time will be set to an I-loaded value by the Abort Control Sequence, based on the abort selected, and item 9 will be computed and displayed as a function of this I-load. In OPS 3, item 9 is initialized to the last value from OPS 1, or to an automatic dump value based on abort selection.

If a new value is entered into item 9 while any OMS dump is in progress, the dump will be based on the new value. If the quantity entered via item 9 exceeds MAX QUAN ENTRY, the entry will be rejected and an 'ILLEGAL ENTRY' message will be displayed.

Items 5 thru 9 are not legal in MM104, MM105, and MM106; attempting to execute these items in these major modes will result in an 'ILLEGAL ENTRY' message.

OMS DUMP TTG (time-to-go) displays the amount of time remaining, in seconds, to dump OMS propellant, whether or not a dump is in progress. In OPS 1, the OMS dump time is initialized to the manual OMS dump time I-load value; any changes thereafter to OMS DUMP TTG will be a function of quantity input by the crew via item 9, an I-loaded value based on the intact abort selected, or the completion of an OMS/RCS interconnect. The OMS DUMP TTG value reflects dump time using a scale factor based on a two OMS engine flow rate. During an OMS/RCS interconnect with RCS jets commanded on, the OMS DUMP TTG computation will be adjusted by a scale factor to reflect the additional RCS flow rates. OMS DUMP TTG decrements as dumping occurs until it reaches zero at which time the dump is terminated.

- (4)\* Items 13 and 15 are used in OPS 3 and 6 to enable (ENA)/inhibit (INH) the aft and forward RCS dumps, respectively. The dumps are initialized enabled, and thereafter will reflect crew inputs, except in OPS 3 when the TAL flag is not set, where dumps are initialized inhibited. Items 14 and 16 are initialized with I-loaded dump times in seconds in OPS 1 and 3 (if the TAL flag is set). In OPS 6 they carry over the last values from OPS 1. Depending on the number of jets involved during a dump, these times will decrement accordingly. In OPS 3 with the TAL flag not set, the times are initialized to 0. MM304 RCS dumps may be enabled by putting in a nonzero dump time via items 14 and 16, and enabling the dumps via items 13 and 15, respectively. The display fields of items 15 and 16 will be blanked during a Contingency Dump, and will cause an 'ILLEGAL ENTRY' message if executed.
- (5) ENTRY FCS. Items 17 and 18 allow the crew to command the aerojet DAP to use an AUTO or FIXED elevon schedule. The display is initialized with the AUTO schedule selected. The FIXED schedule will be used for aero PTIs. For flights with no scheduled PTIs, the aft schedule will be I-loaded into the FIXED slot for use during a no yaw jet entry. Items 20 and 21 can be used to choose the nominal (NOM) or alternate (ALT) body bending filter. The display is initialized with the NOM filter selected. However, if OPS 3 is entered from OPS 1, the ALT (item 21) body bending filter will be selected. An '\*' indicates selection during operation in OPS 3 only. Items 17 and 18 are mutually exclusive, as are items 20 and 21; selection of one automatically deselects the other. In OPS 1 or OPS 6, the '\*' is blanked as the elevon schedule and the body bending filter are I-loaded independent of crew input. These items are legal in OPS 3 only, and will result in an 'ILLEGAL ENTRY' message if executed in any other OPS.

## OVERRIDE (Cont):

Item 19 (SSME REPOS) allows the crew to enable (ENA)/inhibit (INH) the repositioning of the SSMEs which occurs automatically in MM304. The SSME REPOS is initialized blank until OPS 3 when it is set to ENA; thereafter, the status field will reflect crew inputs. Item 19 is legal in MM301, MM302, MM303, and MM304 only, and will result in an 'ILLEGAL ENTRY' message if executed in any other major mode.

Items 22 thru 24 allow the crew to select the atmospheric model used by entry navigation. The display is initialized with the nominal model selected, item 22 (NOM). Items 23 (N POLE) and 24 (S POLE) select north polar and south polar models, respectively. These items are mutually exclusive, with an '\*' displayed next to the currently active model. These items are legal in OPS 3 only; execution in OPS 1 or 6 will have no effect.

- (6) IMU. A parameter status column is provided after each LRU ID number. The column is blank for normal operations, or displays a '↓' for an RM-declared failure or IMU deselection by RM or the crew, a '?' for an RM dilemma, or an 'M' for missing data. The STAT column displays output from the Built-In Test Equipment (BITE) and is either blank (normally) or displays 'BITE' for a detected LRU problem. The ATT column displays which Inertial Measurement Unit (IMU) is selected for use and whether the IMU data are good or not. Bad data are indicated by 'RGA'. Items 25 thru 27 allow reselection/deselection of the LRUs, and are initially blank.
- (7) Priority Rate Limiting (PRL). For each of the three hydraulic systems, two item numbers are provided to allow the crew to manually override/reselect automatic systems management and to deselect/select a hydraulic system. A system which has been automatically downmoded (declared unavailable to PRL) will display a '↓'. The 'failed' system may be forced back into PRL availability by executing its AUT item entry which blanks the '↓' and '\*' in the AUT column and establishes manual systems management. A repeat execution of the AUT item entry restores the automatic systems management and puts an '\*' in the AUT column. The DES item entry allows the option of instructing the Hydraulic SOP to declare a system failed and removes automatic systems management (i.e., drives the '↓', blanks any '\*' in the AUT column, and drives an '\*' in the DES column). A repeat execution of the DES item entry toggles the manual deselection (i.e., blanks the '↓', and blanks the '\*' in the DES column). The items are mutually exclusive and initialized in the AUTO mode. A status column is provided for each system to display a blank for normal or upmoded manual system operation, a '?' for an RM dilemma (as declared by a miscompare of the remaining two transducers in any one hydraulic system), or a '↓' for a failure or downmoded system. If any of these items are executed in MM104, MM105, MM106, MM301, MM302, or MM303, an 'ILLEGAL ENTRY' message will occur. When a manual system override (AUT or DES) is executed in OPS 1, a transition to OPS 3 will clear the manual selections made in OPS 1 and return to auto systems management. Manual systems management will only resume if the manual override is reexecuted in OPS 3.
- (8) ADTA. For each of the four ADTA LRUs, the ADTA-derived altitude in feet (H), ADTA-derived angle of attack in degrees ( $\alpha$ ), and ADTA-derived Mach number (M) are displayed. The parameter status column after the LRU IDs is blank (normally), displays a '↓' for an RM declared failure or crew deselection, a '?' for an RM dilemma, or an 'M' for missing data. Items 34 thru 37 allow deselection/reselection of an LRU. ADTA data are blanked during OPS 1. These items are legal in MM304, MM305, MM602, and MM603. Execution of these items in OPS 1, MM301, MM302, MM303, or MM601 will result in an 'ILLEGAL ENTRY' message.
- (9) ROLL MODE. A status of where RM determines the position of the ENTRY ROLL MODE switch to be is displayed as L GAIN, NO YJET, or AUTO. Should this switch fail, item 42 allows selection of the AUTO position which will result in an '\*' being displayed and the status will read 'AUTO'. The item is initialized deselected, and thereafter reflects crew inputs. Item 42 is legal only in MM304, MM305, MM602, and MM603.
- (10) VENT DOOR CNTL. Items 43 (OPEN) and 44 (CLOSE) provide manual capability to command the forward and aft compartment vent doors, and/or all vent doors depending on the major mode these items are executed in. These items are mutually exclusive. Attempting to execute a command while an operation is in progress will result in an 'ILLEGAL ENTRY' message.

An '\*' is displayed immediately adjacent to an item after it is either manually executed or commanded by an auto control sequence. An 'OP' or 'CL' character string is displayed adjacent to the '\*' after the executed sequence has completed. This character string will continue to be displayed until a subsequent item is commanded, at which time it will be blanked. During a manual or auto sequence, the 'OP' or 'CL' character string field will be blanked.

Item 43 (OPEN) is legal only in OPS 3 and MM602 and MM603. Item 44 (CLOSE) is legal only in MM301 through MM304 and MM602, and in MM305 and MM603 after the ROLLOUT FLAG is

## OVERRIDE (Cont):

set true. Execution of these items in any other Major Mode will result in an 'ILLEGAL ENTRY' message; in addition, the attempted command will be rejected.

A manual CLOSE (item 44) executed in MM301 will cause all doors to be commanded closed. Subsequently, left vent doors 1/2 and 8/9 will automatically be reopened. In MM302 and MM303, executing an item 43 or 44 will command all vent doors open or closed, respectively. A manual OPEN (item 43) in MM304 will cause only the left vent doors 1/2 and 8/9 to open; in MM602, all doors will open. A manual CLOSE in MM304 (or MM602) will command all vent doors closed. All vent doors are commanded closed, regardless of their configuration, at the transition to MM304 (or MM602). Finally, a manual OPEN (item 43) executed in MM305 will command all vent doors open.

- (11)\* ET SEP. Items 38 and 39 allow the crew to select the ET SEP AUTO mode or to initiate External Tank (ET) separation. An '\*' is displayed when either item is selected, and both items are deselected initially. These items are legal only in MM102, MM103, MM104, MM105, MM106, and MM601.
- (12) ET UMB DR. Item 40 provides a backup to the dedicated switch for closing the ET umbilical doors. This item is legal only in MM104, MM105, and MM106 and is deselected initially.
- (13) RCS RM. Item 41 allows the crew to override an RCS MANF VLV microswitch dilemma which has forced the RCS RM to set the valve status to CLOSED. Execution of this item causes RCS RM to set the valve status to OPEN on any valve in dilemma, and puts the Reaction Control (RCS) jets (those without previous ON, OFF, or LK failures that have not been failure overridden) back in the jet availability table.
- (14) WRAP MODE. Item 45 allows the crew to enable or inhibit the flight control system wraparound mode. Execution is allowable only in OPS 3 and at any other time will result in an 'ILLEGAL ENTRY' message. The status field to the right of item 45 is blank until OPS 3 transition, after which it toggles between 'ENA' or 'INH' based on crew selection. If a TAL abort has been declared, it will be initialized to INH. When the wrap mode is active, 'ACT' will be displayed.

## \*PROGRAM NOTES

- (3) Possible Contingency Dump Lockout if Second Dump Request Pre-MECO. In an abort situation which causes an automatic Pre-MECO OMS dump (MM103), if an additional OMS dump is requested during the OMS engine purge process, the dump does not occur, and subsequent requests for contingency OMS dumping are not honored. The same contingency dump lockout can also occur in MM103 when requesting another crew initiated contingency dump during the purge process of a previous contingency dump. Therefore, contingency dumping should only be requested prior to completion of the original OMS dump or after OMS purge completion. (DR 55217)

OMS Propellant Dump Termination Via Arm/Press Switches. If the OMS ARM/PRESS switches are turned OFF during a contingency dump (MM102, MM103, MM601, MM602), OMS RM will fail vote the OMS engines. Attempts to reactivate the dump will also fail. Terminate a dump sequence using item 8 rather than the ARM/PRESS switches. An MM104, MM201, or MM301 PRO allows the OMS engines to fire again. (DR 55306)

- (4) RCS Dump Status May Change to Inhibit in MM304 or MM602. In MM304 or MM602, when dump start initiation conditions are met, the user may see the forward and/or aft RCS DUMP STATUS (items 13 and 15) change from 'ENA' to 'INH'. This occurs if the dump duration (I-LOAD or crew entry) is a negative number.

The negative dump duration allows the dump to remain enabled but not started. The crew may then start a dump during a TAL or an RTLS by entering only one item entry (entering a positive dump duration) instead of two (dump duration and dump enable). (DR 101386)

- (11) ET SEP Switch Default. In OPS 1 (not TAL abort), if the ET SEP switch defaults to 'MANUAL', ET SEP AUTO (item 38) is used to override the function back to AUTO. In OPS 6 or TAL abort, default is to 'AUTO', so item 38 is not needed.

This Page Intentionally Blank

OPS G2 (ORBIT)

OPS G2  
(ORBIT)

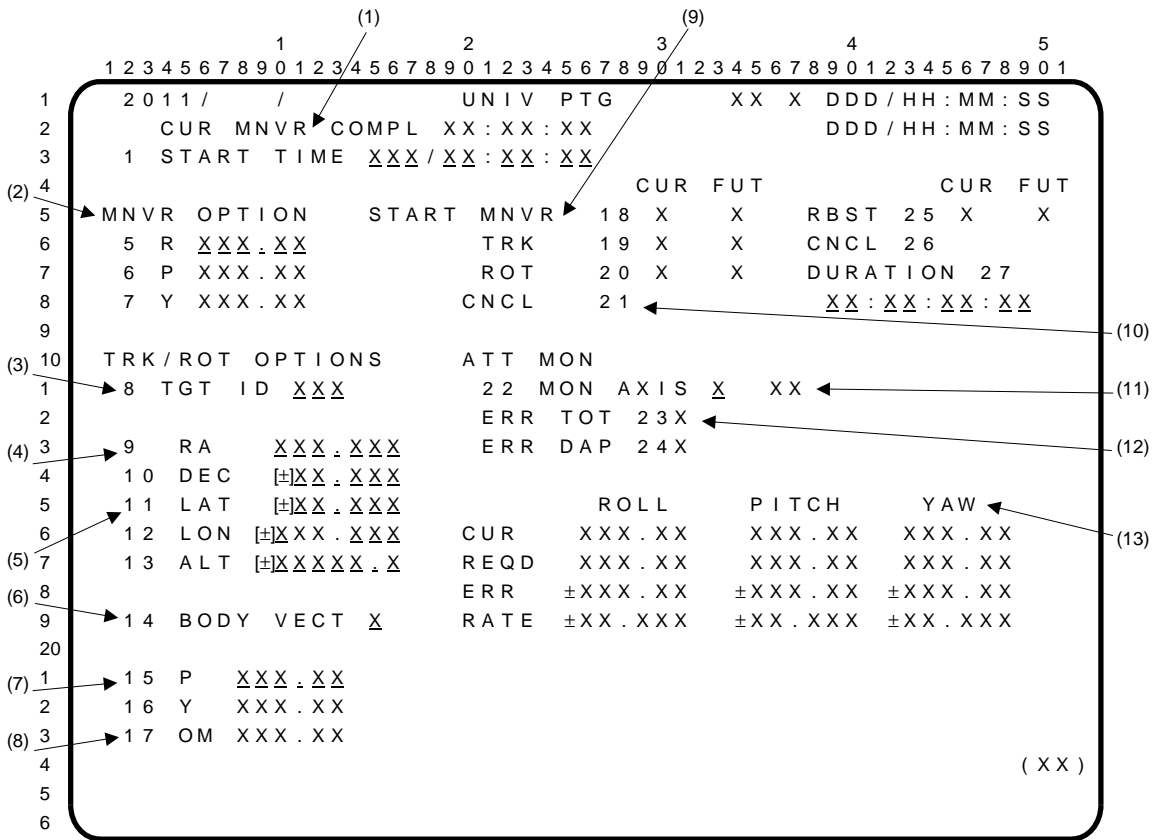

UNIV PTG. A GNC OPS display available in OPS 2 (OPS 2011). This display provides data and controls for auto attitude options and monitoring attitudes, errors, and rates. See table for units and limits.

(1) CUR MNVR COMPL. This field shows in hrs:mins:secs of MET the estimated completion time of the current inertial maneuver (MNVR) or tracking (TRK) option, or the execution time of the current rotation (ROT) option. This time is frozen when the attitude is within a given tolerance of the DAP attitude deadband about the desired attitude, or when the DAP LVLH mode is selected during a maneuver. The time remains unchanged if a maneuver is not in progress and the CNCL, DAP MAN, or LVLH option is selected. Time is reset to zero when CNCL is selected during a maneuver.

START TIME (items 1 thru 4) is designated in days/hrs:mins:secs (MET) for the selected control option. Display is initialized with the time at zero.

(2) MNVR OPTION (items 5 thru 7) provides selection of roll, pitch, and yaw components of the desired final inertial attitude. Display is initialized with inputs at zero.

(3)\* TGT ID (item 8) provides selection of target identification for the TRK option.

<u>TGT ID</u>	<u>LINE-OF-SIGHT TO:</u>
1	Orbiting vehicle
2	Center of Earth
3	Earth relative target
4	Center of Sun
5	Celestial target
6 to 10	Unassigned
11 to 60	Navigation stars, OPS 2, 3, and 8
61 to 110	Navigation stars, OPS 2 and 8

Display is initialized with 2 selected.



UNIV PTG (Cont):

- (4) RA, DEC (items 9 and 10) show right ascension and declination for selected celestial targets (TGT IDs of 4, 5, and 11 to 110). When TGT ID of 5 is selected, the RA and DEC data flash indicating an option is available to change the data via keyboard. Flashing stops when new data are entered, a control option (items 18 thru 20) is selected, or the TGT ID is changed. An attempt to change data when TGT ID is not 5 results in an 'ILLEGAL ENTRY' message. The display is initialized with items 9 and 10 set at zero.

NOTE: Errors in the Universal Pointing solar ephemeris I-loads result in a 1/2-degree error in the center of Sun target vector (ID = 4).

- (5) LAT, LON, ALT (items 11 thru 13) show the latitude, longitude, and altitude of an Earth relative target. When TGT ID of 3 is selected, these parameters flash indicating an option is available to change the data via keyboard. Flashing stops when new data are entered, a control option is selected, or the TGT ID is changed. An attempt to change these parameters when TGT ID is not 3 results in an 'ILLEGAL ENTRY' message. The display is initialized with items 11 thru 13 set at zero.
- (6) BODY VECT (item 14) selects the body vector pointed along the line-of-sight for the TRK option and along the axis of rotation for the ROT option.

<u>Body Vector Identifier</u>	<u>Axis</u>
1	+X
2	-X
3	-Z
4	-Y ST
5	Selectable

Display is initialized with item 14 set at 1.

- (7) P, Y (items 15 and 16) show pitch/yaw components corresponding to the selection made in item 14. When BODY VECT of 5 is selected, the pitch and yaw parameters flash indicating an option is available to change the data via keyboard. Flashing stops when new data are entered, a control option is selected, or item 14 is changed. An attempt to change these parameters when BODY VECT is not 5 results in an 'ILLEGAL ENTRY' message. The display is initialized with items 15 and 16 set at zero.
- (8) OM (item 17) selects Omicron angle for the TRK control option. Entry of any defined TGT ID (item 8) blanks the OM value. Subsequent selection of TRK control option maintains OM blanking, which indicates selection of two axis tracking. If an OM value is entered, subsequent selection of the TRK option initiates three axis tracking. If an OM has been entered previously, execution of item 14 (body vector identifier) causes the OM value to flash, indicating an option is available to change the data via keyboard. Flashing stops when a new value is entered or a control option is selected. Entry of an OM value outside the limit range results in an 'ILLEGAL ENTRY' message. The display is initialized with OM set at zero.
- (9)\* START MNVR, TRK, ROT (items 18 thru 20) provide selection of the maneuver, tracking, or rotation control option, respectively. Initiation of a control option depends on the START TIME entered in items 1 thru 4. If the START TIME is current or in the past and DAP is AUTO, the control option is initiated upon selection, an '\*' appears momentarily in the FUT (future) column next to the selected option, then moves to the CUR (current) column next to the selected option, and any other option is deselected (no '\*'). If the START TIME is in the future, the selected control option is initiated at that time and in the interim an '\*' appears in the FUT (future) column next to the selected option. The selected option in progress ('\*' in the CUR column) drives the REQD attitude, ERR, and the ADI error needles. Control option initiation must be preceded by DAP AUTO. If a future start time is within 30 seconds of current time and AUTO was not selected, a Class 3 alert and 'SEL AUTO' message are generated. Data may be entered for a single future control option during execution of the current option. An '\*' appears in the FUT column next to the applicable option while the '\*' remains in the CUR column next to the current, active option. When the START TIME entered for the future option equals current time, the '\*' in the FUT column is blanked and is displayed in the CUR column. If the previous control option is active, it is deselected (no '\*'). If a future option has been selected and then data related to that particular option are changed prior to the future start time via keyboard inputs, the future option will be deselected (no '\*'), and will automatically maintain the current option. The crew must repeat selection of the desired future option. The three control options are terminated/inhibited

UNIV PTG (Cont):

by: (a) selecting MNVR (item 27) on the ORBIT MNVR EXEC display; (b) selecting MAN or LVLH; (c) taking a powered RHC out of detent; or (d) selecting the CNCL option. Providing that CNCL has not been executed, a control option is reinitiated by: (a) exiting MM202; or (b) selecting AUTO DAP.

- (10) CNCL (item 21) deselects both current and future control options and initiates inertial attitude hold at the current attitude. No '\*' is displayed upon execution. The display is initialized with item 21 selected. When in DAP AUTO and CNCL is selected, attitude errors are displayed with respect to the current attitude when the CNCL option was executed. This attitude reference is maintained in a subsequent selection of a MAN maneuver and return to AUTO DAP. Reselection of the CNCL option zeroes these attitude errors. Errors are then displayed with respect to the current attitude regardless of DAP configuration. CNCL (item 26) only cancels a reboost mnvr.
- (11) MON AXIS (item 22) selects the coordinate reference or attitude monitor axis for display of attitude angles, errors, and rates. Executing '1' with item 22 gives a display of '1 + X'. The attitude monitor quantities are then displayed relative to standard orbiter body axes. Executing a '2' with item 22 gives a display of '2 - X'. The attitude monitor quantities are then displayed relative to the coordinate system rotated 180 deg about the Z axis with respect to standard orbiter body axes. The display is initialized with '1 + X' selected.
- (12) ERR TOT, ERR DAP (items 23 and 24) select total attitude error or digital autopilot attitude error to be displayed by the ADI error needles and the attitude monitor parameters. An '\*' indicates selection. The display is initialized with ERR TOT selected.
- (13) ATT MON displays current and required attitudes, errors as selected by item 23 or 24, and attitude rates. The final required attitude and attitude errors will be displayed while in DAP MAN if a current or future option is selected. Whenever DAP LVLH or CNCL is selected, the required attitude is set equal to the current attitude and attitude errors are set to zero. The display is initialized with required attitude equal to current attitude.

Upon execution of an item 25 (RBST), if the START TIME is current or in the past and DAP is AUTO, the control option is initiated upon selection, an '\*' appears momentarily in the FUT (future) column next to the selected option, then moves to the CUR (current) column next to the selected option, and any other option is deselected (no '\*'). If the START TIME is in the future, the selected control option is initiated at that time and in the interim an '\*' appears in the FUT (future) column next to the selected option. The duration of the auto reboost is set with items 27 thru 29.

\*PROGRAM NOTES

- (3) (9) Enable RNDZ NAV before Target Tracking. Execution of the target tracking option (item 19) with TGT ID (item 8) = 1 when rendezvous navigation is not enabled will cause divide by zero GPC errors. RNDZ NAV (item 1, REL NAV display) must be enabled each time GNC OPS 2 is entered, before attempting to track another orbiting object. (DR 53101)
- (9) Disable Target Tracking before OPS Transition. Target tracking of another orbiting vehicle should be stopped via item 21 before executing an OPS transition or mode recall, or the target state vector may be lost. (DR 58374)

**ITEM ENTRY LIMITS TABLE**

ITEM NUMBERS	CRT NAME	UNITS	LIMITS
	MNVR OPTION		
5	R	deg, M50	0.00 to 359.99
6	P	deg, M50	0.00 to 359.99
7	Y	deg, M50	270.00 to 359.99 and 0.00 to 90.00
	TRK/ROT		
8	TGT ID		1 to 5, 11 to 110 (see text)
9	RA	deg, M50	0.000 to 359.999
10	DEC	deg, M50	-90.000 to +90.000 (+ =North, - = South)
11	LAT*	deg	-90.000 to +90.000 (+ = North, - = South)
12	LON*	deg	-180.000 to +180.000 (+ = East, - = West)
13	ALT*	nm	-3444.0 to 20,000.0
14	BODY VECT		1 to 5 (see text)
15	P	deg	0.00 to 359.99
16	Y	deg	270.00 to 359.99 and 0.00 to 90.00
17	OM	deg	0.00 to 359.99
	ATT MON		
22	MON AXIS		1 to 2 (see text)

\*LAT, LON, and ALT are referenced to the Fischer Ellipsoid.

	1									2									3									4									5								
	1	2	3	4	5	6	7	8	9	1	2	3	4	5	6	7	8	9	1	2	3	4	5	6	7	8	9	1	2	3	4	5	6	7	8	9	1	2	3	4	5	6	7	8	9
1	XXXX/XXX/018									GNC SYS SUMM 1									XX X									DDD/HH:MM:SS																	
2																												DDD/HH:MM:SS																	
3	RCS	JET	ISOL																																										
4	MANF	FAIL	VLV	SURF									POS									MOM									DPS									1	2	3	4	5	
5	F 1	XXX	XXS	L	OB	XXX.XS									XXS	GPC									S	S	S	S	S																
6	2	XXX	XXS	I	B	XXX.XS									XXS	MDM									FF	S	S	S	S																
7	3	XXX	XXS	R	I	XXX.XS									XXS	FA									S	S	S	S	S																
8	4	XXX	XXS	OB									XXX.XS	XXS																															
9	5	XXX	XXS	AIL									XXX.X																																
10	L 1	XXX	XXS	RUD									XXX.X	FCS									CH	1	2	3	4																		
1	2	XXX	XXS	SPD									BRK	XXX.X	S									S	S	S	S																		
2	3	XXX	XXS	BDY									FLP	XXX.X																															
3	4	XXX	XXS	XXXXXX																																									
4	5	XXX	XXS																			NAV									1	2	3	4											
5	R 1	XXX	XXS	CNTLR									1	2	3	IMU									S	S	S																		
6	2	XXX	XXS	RHC									L	S	S	S	ACC									S	S	S	S																
7	3	XXX	XXS										R	S	S	S	RGA									S	S	S	S																
8	4	XXX	XXS										A	S	S	S	TAC									S	S	S																	
9	5	XXX	XXS										THC	L	S	S	S	MLS									S	S	S																
20										SBTC									L	S	S	S	ADTA									S	S	S	S										
1																			A	S	S	S																							
2																			R	S	S	S																							
3																																													
4																																													
5																																													
6																																													

( X X )

GNC SYS SUMM 1 is a GNC display (DISP 18) available in all GNC OPS via the SYS SUMM key. Digital and/or status information which supports RCS manifolds, aerosurfaces, controllers, data processing system (DPS), flight control subsystem channels (FCS CH), and navigation subsystems is displayed.

### PARAMETER CHARACTERISTICS

CRT NAME	UNITS	DISPLAYED RANGE	STATUS INDICATORS				
			M	?	↑	↓	
RCS MANF F(L,R) 1-4 JET FAIL	text	blank, 'ON', 'LK', 'OFF'					
ISOL VLV	text	'OP', 'CL'	M	?			
5 JET FAIL [1]	text	blank, 'ON', 'LK', 'OFF'					
ISOL VLV	text	'CL', 'OP'	M	?			
[3] SURF: L(R) OB(IB) POS	deg	D36.5 to U21.5			↑	↓	
MOM	percent	-99 to +99			↑		
AIL POS	deg	L5.0 to R5.0					
RUD POS	deg	L27.1 to R27.1					
SPD BRK POS	percent	0 to 100					
BDY FLP POS	percent	0 to 100					
[2]	text	See Remarks					
CNTRLR: RHC L(R) 1-3	[4]		M	?			↓
A1-3	[1]		M	?			↓
THC L1-3	[4]		M	?			↓
A1-3	[1]		M	?			↓
SBTC L(R) 1-3	[3]		M	?			↓
DPS: GPC 1-5			M				↓
MDM FF 1-4			M				↓
FA 1-4			M				↓
FCS: CH 1-4	[6]		M				↓
NAV: IMU 1-3	[5]		M	?			↓
ACC 1-4	[6]		M	?			↓
RGA 1-4	[6]		M	?			↓
TAC 1-3	[3]		M	?			↓
MLS 1-3	[3]		M	?			↓
ADTA 1-4	[3]		M	?			↓

GNC SYS SUMM 1 (Cont):

REMARKS

- [1]** OPS 2 and 8 only.
- [2]** The data field below BDY FLP POS indicates pilot valve status: 'blank' for normal; 'HOLD 2' for an RM-detected change in body flap position when no command is present; 'HOLD 1' when 'HOLD 2' fails to correct the change in body flap position; 'CYCLE' indicates that neither 'HOLD 2' nor 'HOLD 1' fixed the problem; 'FAIL' indicates body flap direction is not following the command.
- [3]** OPS 3 and 6 only.
- [4]** OPS 2, 3, 6, and 8 only.
- [5]** OPS 1, 2, 3, 6, and 8.
- [6]** OPS 1, 3, and 6 only.

PROGRAM NOTES

When an FCS channel switch is moved between the AUTO and OVERRIDE positions, a momentary down arrow may appear on GNC SYS SUMM 1 for that channel. This occurs because the switch is of the break-before-make variety causing a momentary loss of power to the ASA during switch movement.

Although RHC LRU fault annunciation is possible in OPS 1, the RHC LRU status fields are blanked in OPS 1 preventing display of RHC failure, dilemma, or comm-fault status. (DR 104639)

	1										2										3										4										5									
	1	2	3	4	5	6	7	8	9	0	1	2	3	4	5	6	7	8	9	0	1	2	3	4	5	6	7	8	9	0	1	2	3	4	5	6	7	8	9	0	1	2	3	4	5	6	7	8	9	0
1	XXXX/XXX/019										GNC SYS SUMM 2										XX X										DDD/HH:MM:SS																			
2																					BFS										DDD/HH:MM:SS																			
3	OMS AFT QTY L					R					OMS					L					R																													
4	OXID XX.XS					XX.XS					TK P					HE					XXXXS XXXXS																													
5	FU XX.XS					XX.XS										OXID					XXXXS XXXXS																													
6	FU INJ T					XXXXS XXXXS										FU					XXXXS XXXXS																													
7	RCS					OXID					FU					JET					ISOL																													
8	FWD					HE P					XXXXS XXXXS					N2 TK P					XXXXS XXXXS																													
9	TK P					XXXXS XXXXS					REG P					XXXXS XXXXS					P VLV					XXS XXXS																								
10	QTY					XXXXS XXXXS					ENG IN					P					OXID					XXXXS XXXXS																								
11	MANF 1 P					XXXXS XXXXS					XXX					XXS					FU					XXXXS XXXXS																								
12	2 P					XXXXS XXXXS					XXX					XXS					VLV 1					XXXXS XXXXS																								
13	3 P					XXXXS XXXXS					XXX					XXS					2					XXXXS XXXXS																								
14	4 P					XXXXS XXXXS					XXX					XXS																																		
15	5										XXX					XXS					OXID					FU					JET					ISOL														
16	AFT					HE P					XXXXS XXXXS					R					HE P					XXXXS XXXXS																								
17	L					TK P					XXXXS XXXXS					TK P					XXXXS XXXXS																													
18	QTY					XXXXS XXXXS										QTY					XXXXS XXXXS																													
19	MANF 1 P					XXXXS XXXXS					XXX					XXS					1 P					XXXXS XXXXS					XXX					XXS														
20	2 P					XXXXS XXXXS					XXX					XXS					2 P					XXXXS XXXXS					XXX					XXS														
21	3 P					XXXXS XXXXS					XXX					XXS					3 P					XXXXS XXXXS					XXX					XXS														
22	4 P					XXXXS XXXXS					XXX					XXS					4 P					XXXXS XXXXS					XXX					XXS														
23	5										XXX					XXS					5										XXX					XXS														
24																															(XX)																			

Note: BFS indicates parameters are driven and displayed on the BFS displays only.

GNC SYS SUMM 2 is a GNC display (DISP 19) available in PASS OPS 2 and 8 and in BFS OPS 1, 3, and 6, via the SYS SUMM key. A summary of RCS propellant, manifold, and jet status data and a summary of OMS quantities, pressures, valve positions, and fuel injector temps are provided.

### PARAMETER CHARACTERISTICS

CRT NAME	UNITS	DISPLAYED RANGE	STATUS INDICATORS							
			M	H	L	↑	↓	?		
OMS: AFT QTY L(R)	OXID, FU [1]	percent	0 to 30.1	M						
FU INJ T	L,R	degF	-75 to +300	M			↑	↓		
RCS: F(L,R) HE P	OXID, FU	psia	0 to 4000	M	H	L	↑	↓		
TK P	OXID, FU [2]	psia	0 to 400	M	H	L	↑	↓		
QTY	OXID, FU	percent	0 to 100	M				↓		
MANF 1-4 P	OXID, FU [3]	psia	0 to 1000	M						
	JET FAIL [3] [4]	text	blank, 'ON', 'OFF', 'LK'							
	ISOL VLV [3] [5]	text	'OP', 'CL'	M						
OMS: TK P HE	L,R	psia	0 to 5000	M				↓		
OXID	L,R	psia	0 to 400	M			↑	↓		
FU	L,R	psia	0 to 400	M			↑	↓		
N2 TK P	L,R	psia	0 to 5000	M				↓		
REG P	L,R	psia	0 to 500	M			↑	↓		
P VLV	L,R	text	'OP', 'CL'	M						
ENG IN P OXID	L,R	psia	0 to 400	M						
FU	L,R	psia	0 to 400	M						
VLV 1(2)	L,R	percent	0 to 100	M						

GNC SYS SUMM 2 (Cont):

REMARKS

- [1]** AFT quantities of oxidizer and fuel are displayed in percent remaining; for missing data (M) the last value of OMS quantity remaining will be displayed until the condition is cleared. '↓' displayed in PASS only.
- [2]** The RCS TK P OXID, FU reflects the outlet pressure of each tank. The RCS TK P OXID, FU indication on PASS SPEC 23 and on the TK P meter reflects ullage pressure.
- [3]** RCS MANF 5 (Vernier Jets) is not supported in BFS.
- [4]** The JET FAIL status indications for BFS are 'ON', 'OFF', or blank; leak is not supported.
- [5]** BFS will display 'M' or blank for RCS manifold isolation valve status post-engage. Not supported pre-engage.

	1										2										3										4										5									
	1	2	3	4	5	6	7	8	9	0	1	2	3	4	5	6	7	8	9	0	1	2	3	4	5	6	7	8	9	0	1	2	3	4	5	6	7	8	9	0	1	2	3	4	5	6	7	8	9	0
1	XXXX / 020 /										DAP CONFIG										XX X DDD / HH : MM : SS																													
2																					DDD / HH : MM : SS																													
3	XXX 1 XXXXXX										2 XXXXXX										PRI DAP EDIT																													
4	ROT RATE	10	X	.	X	X	X	X	X	X	30	X	.	X	X	X	X	X	X	50	X	.	X	X	X	X	X	3	DAP	A	X	X	(2)																	
5	ATT DB	11	X	X	.	X	X				31	X	X	.	X	X				51	X	X	.	X	X		4	DAP	B	X	X	(3)																		
6	RATE DB	12	X	.	X	X					32	X	.	X	X					52	X	.	X	X		5	XXXX																							
7	ROT PLS	13	X	.	X	X					33	X	.	X	X					53	X	.	X	X																										
8	COMP	14	.	X	X	X					34	.	X	X	X					54	.	X	X	X																										
9	P OPTION	15	X	X	X	X					35	X	X	X	X					55	X	X	X	X																										
10	Y OPTION	16	X	X	X	X					36	X	X	X	X					56	X	X	X	X		NOTCH	FLTR	(5)																						
1	TRAN PLS	17	X	.	X	X	X				37	X	.	X	X	X				57	X	.	X	X	X	ENA	6	X																						
2	XXX											ALT																																						
3	RATE DB	18	X	.	X	X	X				38	X	.	X	X	X				58	X	.	X	X	X	X	JETS	ROT																						
4	JET OPT	19	X	X	X	X					39	X	X	X	X					59	X	X	X	X	ENA	7	X																							
5	# JETS	20	X											40	X											60	X																							
6	ON TIME	21	X	.	X	X					41	X	.	X	X					61	X	.	X	X	REBOOST																									
7	DELAY	22	X	X	.	X	X				42	X	X	.	X	X				62	X	X	.	X	X	8	CFG	X																						
8	XXXX											VERN																																						
9	ROT RATE	23	X	.	X	X	X				43	X	.	X	X	X				63	X	.	X	X	X	9	INTVL																							
20	ATT DB	24	X	X	.	X	X				44	X	X	.	X	X				64	X	X	.	X	X	X	X	X	.	X	X																			
1	RATE DB	25	.	X	X	X					45	.	X	X	X					65	.	X	X	X																										
2	ROT PLS	26	X	.	X	X					46	X	.	X	X					66	X	.	X	X																										
3	COMP	27	.	X	X	X					47	.	X	X	X					67	.	X	X	X																										
4	CNTL ACC	28	X											48	X											68	X																							
5																																																		
6																																																		

The DAP CONFIG display provides the capability to review and change On-Orbit DAP parameters. A table of 30 DAP loads is stored in GPC memory for use by the orbit DAP. This table is split into fifteen DAP A loads (A1 through A15) and fifteen DAP B loads (B1 through B15). One DAP A load and one DAP B load are designated and stored as the selected DAP loads. Each DAP load consists of nineteen parameters (rates, deadbands, pulse sizes, etc.) which produce the desired control characteristics of the orbit DAP. The parameters of the selected DAP A and DAP B loads shall be displayed on the DAP CONFIG display by items 10 through 28 and 30 through 48, respectively. The crew can modify these selected DAP load parameters, or select a different DAP load from the DAP table which is pre-flight configured via I-Loads. The crew uses the dedicated DAP A or B PBI to specify which of the selected DAP loads (A or B) is active and is actually being used by the orbit DAP.

- (1) DAP A and DAP B (items 1 and 2) permit the two DAP loads to be selected from the DAP table and displayed. An integer value of 1 through 15 can be entered for either item to indicate the desired DAP load. A leading zero is optional but shall be displayed. Any entries outside this range will result in an 'ILLEGAL ENTRY' message.

When transitioning from OPS 0,1, or 3 to OPS 2, the selected DAP A and B loads shall be initialized to A1 and B1, respectively. Thereafter, the DAP load shall be determined by crew entries. When a DAP load is selected from the DAP table in GPC memory:

- a) the selected DAP load ID (integer 1 thru 15) shall be displayed and
- b) the selected DAP load parameter values shall be displayed by items 10 thru 28 or items 30 thru 48.

There is always a selected DAP A and DAP B load, even though items 1 and 2 may be blank. Item 1 or 2 is blanked if items 10 thru 28, or 30 thru 48 are modified, respectively. Modification of items 10 thru 28 or 30 thru 48 changes the selected DAP parameters, but does not affect the DAP table parameter values stored in GPC memory.

The DAP indicator or DAP ID (DAP AXX or DAP BXX) is displayed double overbright if it is the active DAP load.



## DAP CONFIG (Cont):

- (2) DAP A EDIT and DAP B EDIT (items 3 and 4) are mutually exclusive items which permit the crew to review the DAP table without affecting the selected DAPs and edit the DAP table parameters. An integer value of 1 thru 15 can be entered for either item to designate the desired DAP load to be displayed. A leading zero is optional, but shall be displayed. A value of zero can be entered for either item to indicate cancellation of the editing. A value other than 0 thru 15 for items 3 or 4 shall result in an 'ILLEGAL ENTRY' message.

At OPS 2 initialization, blanks shall be displayed for items 3 and 4 and the display fields associated with items 50 thru 68 are blanked. Only crew item entries can initiate the edit process. When item 3 or 4 is executed with a value of 1 thru 15:

- a) the designated EDIT DAP ID (integer 1 thru 15) shall be displayed,
- b) the other EDIT DAP ID shall be blanked, and
- c) the designated DAP parameter values shall be displayed by the edit parameter set (items 50 thru 68).

When items 3 or 4 are executed with a value of zero, both EDIT DAP IDs shall be blanked, the display fields associated with items 50 thru 68 shall be blanked, and the LOAD next to item 5 shall be displayed at normal intensity and not flashing.

Once the crew has entered an EDIT DAP ID (item 3 or 4), they can change the DAP table values by modifying items 50 thru 68. These EDIT DAP changes to the DAP table are not implemented until the LOAD (item 5) is executed. If the EDIT DAP ID is the same as one of the selected DAP IDs, then when the EDIT DAP changes (items 50 thru 68) are implemented by executing item 5, the selected DAP parameters (items 10 thru 28 or 30 thru 48) will be set to the new EDIT DAP parameter values. If the selected DAP parameters are modified using items 10 thru 28 or 30 thru 48, the EDIT DAP parameters are not affected.

- (3) LOAD (item 5) is used to implement the EDIT DAP changes made to the DAP table via items 50 thru 68. When any of these items are modified, the LOAD shall be displayed double overbright and flashing until item 5 is executed. The EDIT DAP changes are not stored in the DAP table and do not affect the selected DAP parameters until item 5 is executed. If both EDIT DAP A (item 3) and EDIT DAP B (item 4) are blank, execution of LOAD shall result in an 'ILLEGAL ENTRY' CRT message and rejection of the input.

LOAD (item 5) shall be displayed at normal intensity and not flashing at OPS 2 initialization, after item 5 is executed, after item 3 or 4 is executed with a value of zero, and after item 3 or 4 is executed with a value of 1 thru 15 but before any item 50 thru 68 is executed.

- (4) The parameters defined by items 10 thru 28 for the selected DAP A and items 30 thru 48 for the selected DAP B and items 50 thru 68 for EDIT DAP A or B allow for the display and modification of the DAP load parameters as determined by the DAP item entries (items 1 and 2) and the EDIT DAP item entries (item 3 or 4). The jet indicator, PRI or VERN or ALT shall be displayed double overbright to indicate which jets are selected to provide control of the vehicle. A brief description of each DAP parameter is given below.

ROT RATE (PRI and VERN). The rotation rates (also called discrete rates) for primary jets (items 10, 30, 50) and vernier jets (items 23, 43, 63) determine the desired rotation rates to be achieved for a DISC RATE manual command or auto maneuver. The ROT RATE values are specified in degrees/second.

ATT DB (PRI and VERN). The attitude deadbands for primary jets (items 11, 31, 51) and vernier jets (items 24, 44, 64) determine the width of the Orbit DAP phase plane. The same deadband value shall be used for all attitude maneuver axes. The ATT DB values are specified in degrees.

RATE DB (PRI and VERN). The rate deadbands for primary jet (items 12, 32, 52) and vernier jets (item 25, 45, 65) determine the upper and lower boundaries of the DAP phase plane. The same rate deadband value shall be used for all maneuver axes. The RATE DB values are specified in degrees/second.

ROT PLS (PRI and VERN). The rotational pulse size for primary jets (items 13, 33, 53) and vernier jets (items 26, 46, 66) determine the rotational rate resulting from a single manual rotational pulse command. The ROT PLS values are specified in degrees/second.

## DAP CONFIG (Cont):

COMP (PRI and VERN). The rotational compensations for primary jets (items 14, 34, 54) and vernier jets (items 27, 47, 67) determine the allowable rotational rate for a given axis resulting from a rate command about another axis. A zero value specifies no compensation is desired. The COMP values are specified in degrees/second.

P and Y OPTION (PRI). The pitch option (items 15, 35, 55) and yaw option (items 16, 36, 56) for primary jets only allow selection of one of three control modes for the pitch and yaw axes; nose and tail jets, nose jets only, or tail jets only. As any of the item numbers are executed, the display field cycles through the three mode choices (ALL, NOSE, and TAIL).

TRAN PLS (NORM). The translational pulse size (items 17, 37, 57) determines the desired velocity delta resulting from a single manual translational pulse command. The TRAN PLS is specified in feet/second. A zero value may not be entered.

RATE DB (ALT). The rate deadband alternate (items 18, 38, 58) determines the upper and lower boundaries of the DAP phase plane and shall be used for all axes. RATE DB ALT is specified in degrees/second.

JET OPT (ALT). The jet option alternate (items 19, 39, 59) allows for selection of one of two control modes, nose and tail jets (ALL) or tail jets only (TAIL). Selection of nose only is not available. When the items are executed, they shall toggle between the two control modes (ALL and TAIL).

# JETS (ALT). The number of jets alternate (items 20, 40, 60) provides selection of the maximum number of primary jets (1, 2, or 3) allowed to be fired simultaneously while in Alternate Primary Mode.

ON TIME (ALT) and DELAY (ALT). The on time alternate (items 21, 41, 61) and delay time alternate (items 22, 42, 62) determine the maximum duration of each jet firing and the minimum time delay between jet firings, respectively, while in the Alternate Primary Mode. Both the ON TIME and DELAY shall be specified in seconds.

CNTL ACC. The control acceleration (items 28, 48, 68) is used to select one of ten sets of I-load or uplinked mass properties that will be used to calculate the mass property dependent acceleration data for the on-orbit DAP. The control acceleration is also used to select a set of notch filter parameters. The nominal or default orbiter configuration is represented by value 0, while values 1 thru 9 are used for alternate orbiter/payload configurations.

Decimal data entries for items 10 thru 28, 30 thru 48, and 50 thru 68 may be entered to six (6) significant digits total.

- (5) The notch filter enable function (item 6) allows the crew to enable or disable the DAP notch filter capability, subject to possible override by the DAP, when a non-zero control acceleration is selected. An asterisk (\*) is displayed when the notch filter capability is enabled. Item 6 is initialized per the state of the ENABLE\_NF flag from the Orbit DAP. The notch filter parameters control the number of filters active in the DAP state estimator and the frequencies they attenuate. The DAP initializes the notch filter capability to the enabled state each time a new, non-zero control acceleration is selected (via items 28 and 48), provided that the associated notch filter parameters permit it (number of filters greater than zero). The crew can then disable/enable the function as desired. The DAP disables the notch filter capability if the control acceleration is zero or if the number of filters associated with the control acceleration value is zero. The crew cannot override this deselection.

XJETS ROT ENA. The X jets rotation enable (item 7) sets a flag enabling +X and -X PRCS jets to provide rotational control (pitch) while docked to ISS.

REBOOST CFG and INTVL. Reboost config (item 8) provides a choice of jet configurations to be used by the DAP during auto-reboost ops. Reboost interval (item 9) is the time in seconds between pulses during an auto-reboost.

- (6) Implied Item Numbers. Item numbers 29 and 49 are implied and are not legal for use on this display. If either of the item numbers is executed, an operator error results, the input is rejected, and the 'ILLEGAL ENTRY' CRT message is displayed.

**ITEM ENTRY LIMITS TABLE**

ITEM NUMBERS	CRT NAME	AFFECTED RCS MODES	UNITS	LIMITS
1	DAP A	ALL		1-15 (see text)
2	DAP B	ALL		1-15 (see text)
	DAP EDIT			
3	DAP A	ALL		0-15 (see text)
4	DAP B	ALL		0-15 (see text)
	REBOOST			
8	CNFG	ALL		1-4 (see text)
9	INTVL		sec	0.08-999.99
	PRI			
10, 30, 50	ROT RATE	PRI,ALT	deg/sec	0.0500-2.0000
11, 31, 51	ATT DB	PRI,ALT	deg	0.10-40.00
12, 32, 52	RATE DB	PRI	deg/sec	0.10-5.00
13, 33, 53	ROT PLS	PRI,ALT	deg/sec	0.001-1.000
14, 34, 54	COMP	PRI,ALT	deg/sec	0.000-0.999
15, 35, 55	P OPTION	PRI		(see text)
16, 36, 56	Y OPTION	PRI		(see text)
17, 37, 57	TRANS PLS	PRI	ft/sec	0.001-1.000
	ALT			
18, 38, 58	RATE DB	ALT	deg/sec	0.050-5.000
19, 39, 59	JET DPT	ALT		(see text)
20, 40, 60	# JETS	ALT		1-3 (see text)
21, 41, 61	ON TIME	ALT	sec	0.08-9.99
22, 42, 62	DELAY	ALT	sec	0.00-99.99
	VERN			
23, 43, 63	ROT RATE	VERN	deg/sec	0.0020-1.0000
24, 44, 64	ATT DB	VERN	deg	0.010-40.000
25, 45, 65	RATE DB	VERN	deg/sec	.010-.500
26, 46, 66	ROT PLS	VERN	deg/sec	.001-.500
27, 47, 67	COMP	VERN	deg/sec	0.000-.999
28, 48, 68	CNTL ACC	VERN,ALT		0-5 (see text)

```

1 2 3 4 5 6 7 8 9 0 1 2 3 4 5 6 7 8 9 0 1 2 3 4 5 6 7 8 9 0 1 2 3 4 5 6 7 8 9 0 1
(1) (2) (3) (4) (5) (6) (7)
1  XXXX / 0 2 1 /          IMU ALIGN          XX X DDD / HH : MM : SS
2  IMU                      DDD / HH : MM : SS
3  1 S      2 S      3 S
4  STAT  XXXX  XXXX  XXXX          ALIGN XXX
5  TEMP   XX   XX   XX          IMU 1 10X  REF STAR 1 3X
6  STBY   2 1X  2 2X  2 3X          2 11X          IMU 1 4 X
7  OPER   4 X   5 X   6 X          3 12X  TYPE 15 XXXXX
8  DES    7 X   8 X   9 X
9
10  EXEC 16 X
(3) 1  ACC                      TERM 17
2
3  X  ±X . XX  ±X . XX  ±X . XX          IMU BITE MASK ←
4  Y  ±X . XX  ±X . XX  ±X . XX          1  XXXX  2 4 X
5  Z  ±X . XX  ±X . XX  ±X . XX          2  XXXX  2 5 X
6
(4) 7  ANG                      3  XXXX  2 6 X
8
9  X  XXX . XX  XXX . XX  XXX . XX          NAV ΔV THRESH ←
20 Y  XXX . XX  XXX . XX  XXX . XX          1 8  XXXXXX
1  Z  XXX . XX  XXX . XX  XXX . XX          MM READ 19 X
2  ΔX ±XXXX . XX ±XXXX . XX ±XXXX . XX
3  ΔY ±XXXX . XX ±XXXX . XX ±XXXX . XX
4  ΔZ ±XXXX . XX ±XXXX . XX ±XXXX . XX
5
6  ( X X )

```

(1) IMU ALIGN. A GNC SPEC (21) available in OPS 2 and 3. The SPEC provides the capability to monitor and control the on-orbit IMU hardware and software mode status and alignment submode. This display is also used to mask IMU BITEs.

(2)\* IMU. A status parameter is displayed beside each IMU number. An 'M' is displayed if its data are missing. A '↓' is displayed whenever RM declares an IMU failed or an IMU is deselected automatically by RM or manually by the crew via Item 7, 8, or 9. A '?' is displayed by each IMU participating in the voting logic for an RM dilemma. The status (STAT) of each IMU is output as 'BITE' (double overbright), 'OFF', or blank. If the temperature status discrete indicates all temperatures (TEMP) are within tolerance, 'OK' is displayed; when the temperatures are out-of-tolerance low, 'LO' is output; and when temperatures are out-of-tolerance high, 'HI' is output (double overbright). The HI indication takes precedence. For any IMU, STBY and OPER modes are mutually exclusive. An '\*' is displayed next to the currently active mode.

Items 21 thru 23 provide controls to select the standby (STBY) mode of operation.

Items 4 thru 6 allow selection of the operate (OPER) mode. Ensure that the asterisk appears by the OPER item before selecting an IMU for use. The asterisk is indicative of internal IMU Operate Sequence completion.

Items 7 thru 9 provide controls to select or deselect the IMUs for the selection filter. An '\*' beside the appropriate item number indicates that the IMU has been deselected or declared failed by RM.

(3) ACC. The accelerometer outputs from all IMUs are transformed into M50 coordinates. Acceleration is displayed in feet per second squared.

(4) ANG. Outputs (X, Y, Z) are displayed representing the body to M50 Euler angles in degrees, as computed for each IMU in the Z, Y, X Euler order. The Z and Y angles can be used to determine the RA and DEC pointing angles of the spacecraft +X axis. The Z angle is equal to the RA and the minus Y angle is equal to the DEC. If Item 15 indicates TORQUE, the delta angles (ΔX, ΔY, ΔZ) are displayed in degrees as the difference between the desired cluster-to-M50 and the present cluster-to-M50 orientation. If Item 15 indicates MATRIX, the delta angles represent the difference between the current cluster-to-M50 and the present cluster-to-M50 orientation. The delta angles are updated for display once per minute. Therefore, it is necessary to wait 1 minute or until the angles are observed to change to ensure that they reflect the selected star pair.

## IMU ALIGN (Cont):

(5)\* ALIGN XXX. Items 10 thru 12 are used to select or deselect the IMUs to be aligned. An '\*' is driven next to the option (1, 2, or 3) currently selected. An attempt to change the IMU to be aligned while alignment is in progress will result in an 'ILLEGAL ENTRY' message. Executing an alignment (Item 16) with no IMUs selected for alignment will result in an 'ILLEGAL ENTRY' message. For Star Align (Item 13), either TORQUE or MATRIX, 'ENA' is driven after the word ALIGN when the star tracker module has determined that automatic star selection has resulted in sufficient star sighting data to perform an alignment (star angle separation is within  $90 \pm 55$  degrees). Violation of this threshold will nominally inhibit star alignment (although  $\Delta$ ANGs are still calculated using data from stars in slots 2 and 3); however, 'manual' selection of stars (via Items 17, 18, and 19 on SPEC 22) with angle separations that exceed  $90 \pm 55$  degrees will allow star alignment, without the 'ENA' indication. Note: 'ENA' always appears for COAS stars.

Item 13. REF STAR is used to select star data (obtained with either Star Tracker or COAS sightings) as reference (REF) data for IMU alignment. Item 13 is the default data source. Item 13 will be active whenever the display is first called, an alignment is completed, or an alignment is terminated (with Item 17). When Item 13 is active an asterisk (\*) is driven next to it. Item 13 supports two modes of alignment. If Item 13 is active and Item 15 (TYPE) indicates TORQUE, a command to align (Item 16) will utilize Star Tracker/COAS data to reposition IMU platforms (selected by Items 10-12) to the desired orientation. Item 13 may also be used in conjunction with Item 15 to perform a matrix alignment based on star data. If Item 13 is active and Item 15 indicates MATRIX, execution of Item 16 will recompute the selected IMU's platform orientations without physical repositioning. Item 13 will be reset off (asterisk blanked) whenever Item 14 is activated (by the entry of a reference IMU number).

Item 14. REF IMU is used to designate an IMU as the source of alignment reference data. The designated reference number (1, 2, or 3) is displayed to the right of the item label. Item 14 also supports two modes of alignment. If Item 14 indicates a reference IMU and Item 15 (TYPE) indicates TORQUE, a command to align (Item 16) will reposition the selected IMUs (Items 10-12) to the desired orientation. This is an IMU/IMU align.

If Item 14 indicates a reference IMU and Item 15 indicates MATRIX, a command to align (Item 16) will compute platform orientations in a similar fashion to the matrix alignment associated with Item 13, i.e. orientations of the selected IMUs are computed, without repositioning. This is a Matrix Align using IMU Data. Notes: (1) If the reference IMU is the only IMU to be aligned with this option, the matrix update consists of copying the desired matrix to the current matrix. (2) If the reference IMU is selected for alignment in addition to at least one other IMU, the reference IMU will be a null operation.

Items 13 and 14 are mutually exclusive. Entering a value for Item 14 will blank the asterisk adjacent to Item 13. Item 14 will be reset (data entry blanked) whenever an asterisk is indicated for Item 13. Note: Executing an IMU align when the reference IMU is not in operate (OPER) mode will result in an 'ILLEGAL ENTRY' message.

Item 15. TYPE selects the alignment type (MATRIX or TORQUE) in conjunction with either Item 13 or Item 14. The platform is either moved (TORQUE) or the platform's current orientation is recomputed without movement (MATRIX), independent of Item 13 or Item 14. When matrix alignment is selected, via Item 15, "MATRIX" will be displayed in the adjacent field. When matrix alignment is not selected, "TORQUE" will be displayed. Prior to execution of Item 16, Item 15 may be switched (i.e. it may be toggled). The default alignment selection is TORQUE. Item 15 will display TORQUE whenever the display is first called, an alignment is completed, or alignment is terminated (with Item 17).

Item 16. EXEC is the functional control used to cause the alignment submodes to be executed. An attempt to execute this item in any of MM302, MM303, MM304, or MM305 after selecting a star align will result in an 'ILLEGAL ENTRY' message being displayed. An '\*' appears next to Item 16 when an alignment mode is active and is reset (blank) when the alignment is complete. Execution of Item 16 while an alignment is already in progress will result in an 'ILLEGAL ENTRY' message. Note: Execution of an align option, using stars, with less than two stars selected for the alignment will result in an 'ILLEGAL ENTRY' message and rejection of the input.

If an alignment is in progress (Item 16 - '\*') when the display is dropped, the alignment continues to completion. Upon completion of the alignment, the REF STAR (Item 13) and TORQUE (Item 15) options will be reselected automatically. If an alignment mode was selected but not initiated (Item 16 was not executed), and the display is dropped, the last selected mode will be retained upon recall of the display.

Item 17. Execution of Item 17 (TERM) terminates any selected alignment option and reselects the STAR ALIGN option. Items 16 and 17 are mutually exclusive. Requesting an alignment termination when an alignment is not in progress will result in an 'ILLEGAL ENTRY' message.

- (6) IMU BITE MASK. Items 24 thru 26 allow the crew to mask any BITEs present on IMUs 1, 2, and 3. An '\*' is driven next to the item number selected. Execution of these items masks only those BITEs already present; in order to mask any new BITEs, masking must be terminated and then reactivated. The data displayed under BITE reflects the current BITE status – not the mask status.
- (7) Item 18. NAV  $\Delta V$  THRESH allows crew selection during OPS 2 of the IMU NAV acceleration threshold (in micro g's) above which navigation uses IMU delta Vs for state propagation during FCS C/O, on orbit, and rendezvous operations. An I-loaded value is initially displayed but thereafter reflects crew inputs. For transitions between OPS 2 and OPS 8, the latest threshold value will be retained.
- Item 19. Execution of Item 19 (MM READ) causes IMU calibration data to be read from mass memory for the IMUs selected by Items 10 thru 12. An '\*' is displayed when READ is in progress. 'ILLEGAL ENTRY' will result if item entries are attempted during MM READ.

\*PROGRAM NOTES

- (2) IMU Operate Mode Indication. It is possible for the IMU LRU to be in the operate mode (as indicated by an OPER asterisk) but for the software to still be in an IMU STBY state. The ACC and ANG data for that IMU will be indicating zeroes in this situation. The problem can be corrected by executing the OPER item number for that IMU. (No DR)
- (5) Unexpected 'ILLEGAL ENTRY' when Selecting IMU Alignment. If the Bite Test 4 MDM initialization read is bypassed at OPS 2 or 3 transition, the output discrete that indicates the IMU is 'In Operate' is set to zero. Any IMU to IMU alignment entry (Item 16) with an IMU whose 'In Operate' output discrete is zero fails with an 'ILLEGAL ENTRY'. If this occurs, select Item 4, 5, or 6 (OPERATE) to set the 'In Operate' output discrete for the reference IMU and repeat the alignment. (DR 100520)

	1										2										3										4										5																			
(2)	1	2	3	4	5	6	7	8	9	0	1	2	3	4	5	6	7	8	9	0	1	2	3	4	5	6	7	8	9	0	1	2	3	4	5	6	7	8	9	0	1	2	3	4	5	6	7	8	9	0										
1	XXXX / 022 /										S TRK / COAS CNTL										XX X										DDD / HH : MM : SS																													
2																															DDD / HH : MM : SS																													
3	S TRK CNTL -Y -Z										S TABLE										1										2										3																			
4	SELF-TEST 1X 2X										TRK ID										XXX										XXX										XXX																			
5	STAR TRK 3X 4X										Δ MIN										XXX										XXX										XXX																			
6	TGT TRK 5X 6X										ANG DIF										XXX X										XXX X										XXX X																			
7	BREAK TRK 7 8										ERR										XX XX										XX XX										XX XX																			
8	TERM / IDLE 9X 10X										SEL										17X										18X										19X																			
9											S TABLE CLR										20																																							
10																																																												
1	S TRK										-Y										-Z										COAS																													
(3) 2	REQD ID 11										XXX										12										XXX										REQD ID 21										XXX									
3	TRK ID										XXX										XXX										Δ DEG X										±X X																			
4	S PRES										X										X										Y										±X X																			
5	Δ ANG ±X XX										±X XX										SIGHT MODE										2 2 X																													
6	THOLD 13										X										14										X										ACCEPT										2 3									
7	SHUTTER										XX										XX										CAL MODE										2 4 X																			
8	MAN OP 15X										16X										DES										2 5 X																													
9	STATUS										XXXXXXXXXX										XXXXXXXXXX										POS X 2 6 X										-Z 2 7 X																			
20	XXXX										XXXX										Δ BIAS X XX										X XX																													
1																					UPDATE 2 8										2 9																													
2																																																												
3																																																												
4																															( X X )																													
5																																																												
6																																																												

- (1) S TRK/COAS CNTL. A GNC SPEC (SPEC 22) available in OPS 2 and 3. If SPEC 22 is requested in MM302 thru MM305, an 'ILLEGAL ENTRY' message will occur and any pages overlaying the OPS display will be canceled. The SPEC provides a means of monitoring and controlling star tracker operation and moding. It also provides the data and controls necessary to perform COAS sightings and calibration.
- (2) S TRK CNTL. Items 1 and 2 allow selection of the SELF-TEST mode for the -Y and -Z star trackers, respectively. Items 3 and 4 select the star track (STAR TRK) submode of operation. Both the -Y and -Z trackers can track simultaneously. An '\*' appears next to the item number of the active S TRK CNTL mode and remains until another selection is made. Items 5 and 6 select the target track (TGT TRK) mode (-Y or -Z, respectively) for rendezvous. Execution of items 7 and 8 forces the star tracker to break track (BREAK TRK) with the current star and begin tracking the next star encountered in the search pattern. Execution of items 9 and 10 (TERM/IDLE) terminates all star tracker processing except that required to obtain BITE and to support display requirements. An '\*' is displayed next to the item number when it has been selected.
- (3) S TRK. Items 11 and 12 (REQD ID) allow input of the ID of a desired star to be tracked. A zero entry allows automatic star selections. (Valid star IDs are 11 thru 60 in OPS 3, 11 thru 110 in OPS 2 and 8.) TRK ID outputs a code indicating which star or target is currently being tracked. In the absence of a valid star or target ID, the ID field is zeroed. The star present (S PRES) location outputs an '\*' whenever a star is being tracked by the star tracker. The delta angle (ΔANG) in deg output is the angle between the expected star line-of-sight and the actual measured line-of-sight.

Items 13 and 14 allow input of a magnitude threshold (THOLD) for star tracking. Valid inputs are 0, 1, 2, or 3. The SHUTTER position for each star tracker is shown as 'OP' for open or 'CL' for closed. Execution of items 15 and 16 (MAN OP) either forces the shutter open or returns shutter control to the automatic mode. An '\*' appears next to the appropriate item number when the shutter is being forced open. While the shutter is forced open there is no bright object protection. If the Sun or the sunlit Earth enters the tracker FOV, there is a possibility of damaging the tracker. The STATUS of the star tracker is output as 'ST FAIL', 'ST PASS', 'FALSE TRK', 'OUT FOV', 'HI RATE', 'NO TARGET', or blank. The line below the status line is used to display BITE (double overbright) when any of the BITE discrettes indicate that a failure has been detected.

## S TRK/COAS CNTL (Cont):

- (4) S TABLE. Data are displayed in three columns where the far left column (1) represents the current or most recent data. Columns 2 and 3 represent progressively older data. Track ID (TRK ID) is a code associated with each star in the table.  $\Delta$ MIN shows how old each input is in minutes. The angular difference (ANG DIF) output displays the measured separation angle between the two stars. Angle error (ANG ERR) is the difference between the ANG DIF computed from the star catalogue and the ANG DIF computed from the star tracker measurements. Items 17, 18, and 19 (SEL) allow selection of the star pair used to compute the alignment data. '\*'s next to the item numbers indicate the star pair selected. The item numbers act as flip-flops.

NOTE: The selections will remain in force until a new star is tracked and input to the table, at which time the system reverts to automatic selection. This can be inhibited by executing TERM/IDLE (items 9 and 10). Item 20 clears all data from the star table for both star tracker and COAS sightings.

- (5)\* COAS. Item 21 (REQD ID) allows input of the star or target on which COAS marks are to be made. The  $\Delta$ DEG X and Y output parameters display the equivalent -Z COAS offsets of a star or target being tracked by the -Z axis star tracker. (These X and Y offsets are aligned with the orbiter X and Y body axis coordinates; that is, +X toward the nose and +Y toward the starboard wing.) Item 22 selects the COAS SIGHT MODE in which the ADI ATT REF button performs the COAS mark function and is disabled from its ATT REF function. Item 23 (ACCEPT) accepts the COAS mark and allows processing of the 'mark' data (applies to COAS STAR SIGHT MODE only). Item 24 selects the COAS calibration mode (CAL MODE). Execution of item 25 deselects (DES) COAS operation and causes an '\*' to appear next to the item number. Items 22, 24, and 25 are mutually exclusive. Items 26 and 27 allow selection of the mounting location (POS) of the COAS (either +X or -Z, respectively). The calibration ( $\Delta$ BIAS) in deg outputs the angular difference between the loaded COAS line-of-sight and the measured calibration COAS line-of-sight in NAV BASE coordinates. Items 28 and 29 (UPDATE) are used to incorporate a new COAS bias.

### \*PROGRAM NOTES

- (5) COAS ACCEPT without Mark. Current software makes no check to ensure a COAS mark has been taken as a condition for processing an ACCEPT item selection. Therefore, erroneous data could go into the star table. This might only be apparent to the crew after a second (valid) star is sighted and the ANG DIF shows a significant error from the expected angular separation. If an ACCEPT command is inadvertently entered without a mark, complete current processing by entering the second ACCEPT command, reinitialize by entering a star table clear (item 20), and then perform the normal sight mode procedure. (DR 35151)

COAS Operation from AFT Station in OPS 3. Marks from the aft station are not detected by flight software in OPS 3 because switch processing does not occur in OPS 3 for the aft station. COAS operations should only be performed at the forward station during OPS 3. (DR 35151)



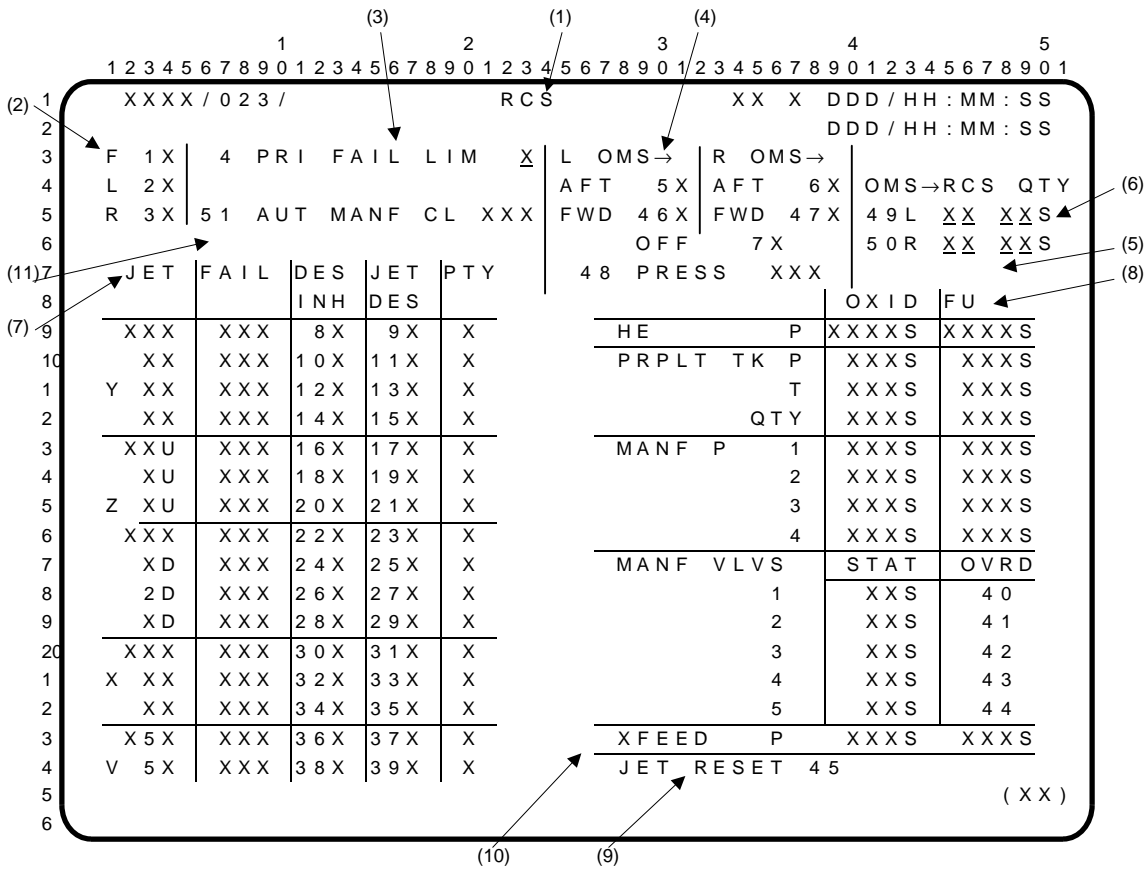

- (1) RCS display. Available as a GNC SPEC (SPEC 23) in OPS 1, 2, 3, 6, and 8, it provides the capability to select the desired RCS module for display of RM and system data, monitor and control the RCS RM, and control the RCS crossfeed and RCS/OMS interconnect operations.
- (2) F, L, R. Items 1, 2, and 3 are used to select the desired RCS pod for data display. Item 1 selects forward (F) RCS pod data to be shown; item 2 selects aft left (L) RCS pod data; and item 3 selects aft right (R) RCS pod data. Item 1 is initially selected and thereafter reflects crew selection. An <sup>(\*)</sup> appears next to the selected item number.
- (3) PRI FAIL LIM. Item 4 allows the crew to input the number of failures which can cause jets to be removed from the table of available jets, by RM, for each pod. The limit applies to primary jets only and is initially I-loaded and thereafter reflects crew inputs.
- (4) L, R OMS TO AFT. Item 5 is used to initiate gauging of OMS propellant used by RCS and automatic OMS ullage pressure maintenance for the left (L) OMS. Item 6 is used to perform a similar function from the right (R) OMS. Item 7 terminates the gauging and ullage pressure maintenance. Item 7 (OFF) is the default selection and thereafter reflects crew inputs. These three items are illegal in OPS 1, 3, and 6. Item 46 and item 47 were created for the Forward RCS Interconnect System Upgrade. Since this hardware upgrade was cancelled, these 2 items are illegal in all OPS.
- (5) PRESS ENA (INH). Item 48 is a toggle between enable and inhibit. This provides capability to inhibit the OMS pressurization software. This software is enabled with an item 5 or 6 (see L, R OMS TO AFT above) and will automatically repress the OMS tanks if the OMS Helium/Vapor Isolation switch is in GPC and the OMS ullage pressure is below the low limit. If an item 48 is executed one time, then the repress software will be inhibited. When executed a second time, the repress software will be re-enabled.
- (6) OMS TO RCS QTY. Digital readouts of left and right OMS propellant used by the RCS system are provided in percent of total OMS quantity when the OMS-to-RCS interconnect is enabled. Items 49 and 50 allow the crew to update the interconnect quantity displayed from the left OMS or the right OMS, respectively. The interconnect counter works in OPS 2 and 8 only. The counter will be passed and displayed for OPS 3 transitions, but the counter will not update with additional interconnect usage.

RCS (Cont):

(7) JET. Table of RCS jet RM status and controls.

The JET ID is a three-character field which represents RCS pod (F, L, R), jet manifold (1, 2, 3, 4, 5), and JET exhaust direction – L (left), R (right), U (up), D (down), F (forward), A (aft). (For example, JET F1D is FWD RCS, MANF 1, fires DOWN.) The JET column will appear as follows for the three selections.

PRIMARY JETS

JET DIRECTION	RCS POD			ITEM NUMBERS
	FWD/LEFT/RIGHT			
Y	F1L	L4L	R4R	8,9
	3L	2L	2R	10,11
	2R	3L	3R	12,13
	4R	1L	1R	14,15
Z	F1U	L4U	R4U	16,17
	3U	2U	2U	18,19
	2U	1U	1U	20,21
	F1D	L	R	22,23
	3D	4D	4D	24,25
	2D	2D	2D	26,27
	4D	3D	3D	28,29
X	F1F	L3A	R1A	30,31
	3F	1A	3A	32,33
	2F			34,35

VERNIER JETS

V	F5L	L5L	R5R	36,37
	5R	5D	5D	38,39

FAIL RM status is shown in the FAIL column. An 'ON', 'OFF', or 'LK' (leak), as appropriate, appears in the FAIL column if RM detects a failure. In the event of multiple failures in a single jet, JET FAIL status will show the last detected failure. The DAP priority (1-4) for each primary jet in the selected pod is displayed below PTY. Vernier jet PTY status is blank. MANF 5 status is not supported in OPS 3.

Items 8, 10, 12,... 38 (DES INH) may be used to prevent automatic deselection of a failed 'OFF' or 'LK' jet. (RM does not auto deselect a failed 'ON' jet.) When a DES INH item entry has been executed from not inhibited to inhibited, an '\*' will appear next to the item number, RM will continue to annunciate failures, but will not automatically deselect the affected jet. In addition, the priority (PTY) of the affected jet will be changed to the lowest priority for that jet group. The priorities of other jets in the group which were lower than the affected jet will be moved up by one. (Priority changes are reflected in the PTY column.) The second execution of a particular DES INH item (i.e., 'toggle RM') blanks the associated '\*' and clears jet fail status flags. If that particular jet is subsequently reselected, its RM auto deselect capability is active for subsequent failures. Reexecuting the DES INH item (from inhibited back to not inhibited) has no effect on the jet's priority.

Items 9, 11, 13,... 39 are used to select or deselect (DES) jets from use by the DAP. The items work as flip-flops. If the jet is selected, executing the item deselects the jet; and if it is deselected, executing the item selects the jet. The '\*'s indicate when a jet is deselected. A jet can be deselected automatically by RM for 'OFF', 'LK' failures or a manifold STAT = 'CL', and manually reselected via items 9, 11,... 39 entry if the manifold valve STAT is 'OP'. If reselected, the failure indication will continue to be displayed, the RM failure monitor will be unable to annunciate any subsequent occurrence of the original failure for that jet, the '\*' will be blanked and the jet will be returned to the availability table with no change in priority.

RCS (Cont):

- (8)** A table of RCS propellant systems data for both fuel (FU) and oxidizer (OXID) is on the right side of the display. The data shown on the display are: helium pressure (HE P), propellant (PRPLT) tank pressure (TK P), temperature (T), quantity (QTY), manifold (MANF) pressures (P) forward, left, and right 1, 2, 3, 4, and isolation valve (MANF VLV 1, 2, 3, 4, 5) positions ('OP' for open and 'CL' for closed), as determined by RM. Items 40 thru 44 allow the crew to override the manifold isolation valve status. Execution of any of these item numbers causes the software status of that manifold valve (as indicated in the STAT column) to switch to the alternate state (OP to CL, or CL to OP). The manifold status is not constrained to remain in the overridden state and will reflect software reevaluation of the valve status if the software detects a subsequent status change. Parameter characteristics and status indicators for the data provided in this portion of the display are as follows:

CRT NAME	UNITS	DISPLAYED RANGE	STATUS INDICATORS					
			M	H	L	↑	↓	?
HE P	psia	0 to 4000	M				↓	
PRPLT TK P	psia	0 to 400	M			↑	↓	
T	degF	0 to 160	M			↑	↓	
QTY	percent	0 to 100					↓	
MANF P (1,2,3,4)	psia	0 to 1000	M					
VLVS 1-5	text	'OP' or 'CL'	M					?
XFEED P	psia	0 to 1000	M					

- [1]** The nominal displayed range is not restricted to 0 thru 100 and could be somewhat lower (negative) or higher.
- (9)** JET RESET. Item 45 allows the crew to manually reset all failed jets that have not been automatically or manually deselected and also resets all fail counters to zero. Execution of item 45 clears the fail column for those jets which have not been automatically or manually deselected, provided the associated manifold isolation valve is open.
- (10)** XFEED P. Selection of item 1 (FRCS) will result in the field being blanked in both OXID and FU.
- (11)** AUT MANF CL. Item 51 enables or inhibits the automatic closure of a RCS manifold with a Failed ON jet. ENA is displayed when the function is enabled. INH is displayed when the function is inhibited. This option is only available in OPS 2 and 8.

## JET SELECTION TABLE

JET GROUP		1	2	3	4	5	6	7	8	9	10	11	12	13	14
TRANS, ORBIT,	1	F1F	F3L	F4R	F3U	F4D(R)	F3D(L)	R3A	L3A	L1L	R3R	L1U	R1U	L3D	R3D
	2	F2F	F1L	F2R	F1U	F2D(R)	F1D(L)	R1A	L1A	L3L	R1R	L4U	R4U	L2D	R2D
AEROJET/GRTLS,	3	F3F			F2U					L4L	R2R	L2U	R2U	L4D	R4D
DAP	4									L2L	R4R				
R															
O	+P					1 [2]	1 [2]					1	1		
T	-P				1									1	1
A	+R												1	1	
T	-R											1			1
I	+Y		1								1 [6]				
O	-Y			1						1 [6]					
N															
T [1]															
R	+X							1 [3]	1 [3]						
A	-X	2													
N	+Y		1							1					
S	-Y			1							1				
L	+Z				1 [4]							1 [4]	1 [4]		
A	-Z														
T	(OPS 1)					2 [5]	2 [5]							3 [5]	3 [5]
I															
O	-Z														
N	(OPS 2,3)					1	1							2	2

Table applies to single axis maneuvers in each of the three DAPs – TRANS, ORBIT, and AEROJET/GRTLS. For each maneuver, the number of jets which will be commanded to fire within each jet group is shown. Within each jet group, the I-loaded priority for selection is top to bottom.

- NOTES: [1] No translation capability exists in the AEROJET/GRTLS DAPs.  
[2] In the TRANS DAP, for a +PITCH rotation, groups 5 and 6 are both removed from the table if both jets in either group are deselected.  
[3] In the TRANS DAP, two jets are used in groups 7 and 8.  
[4] In the ORBIT DAP, a HIGH +Z translation utilizes three jets from each of groups 4, 11, and 12.  
[5] A single jet deselection in any group will cause all groups to be downmoded by one jet.  
[6] AEROJET DAP roll reversals use 2 jets minimum.

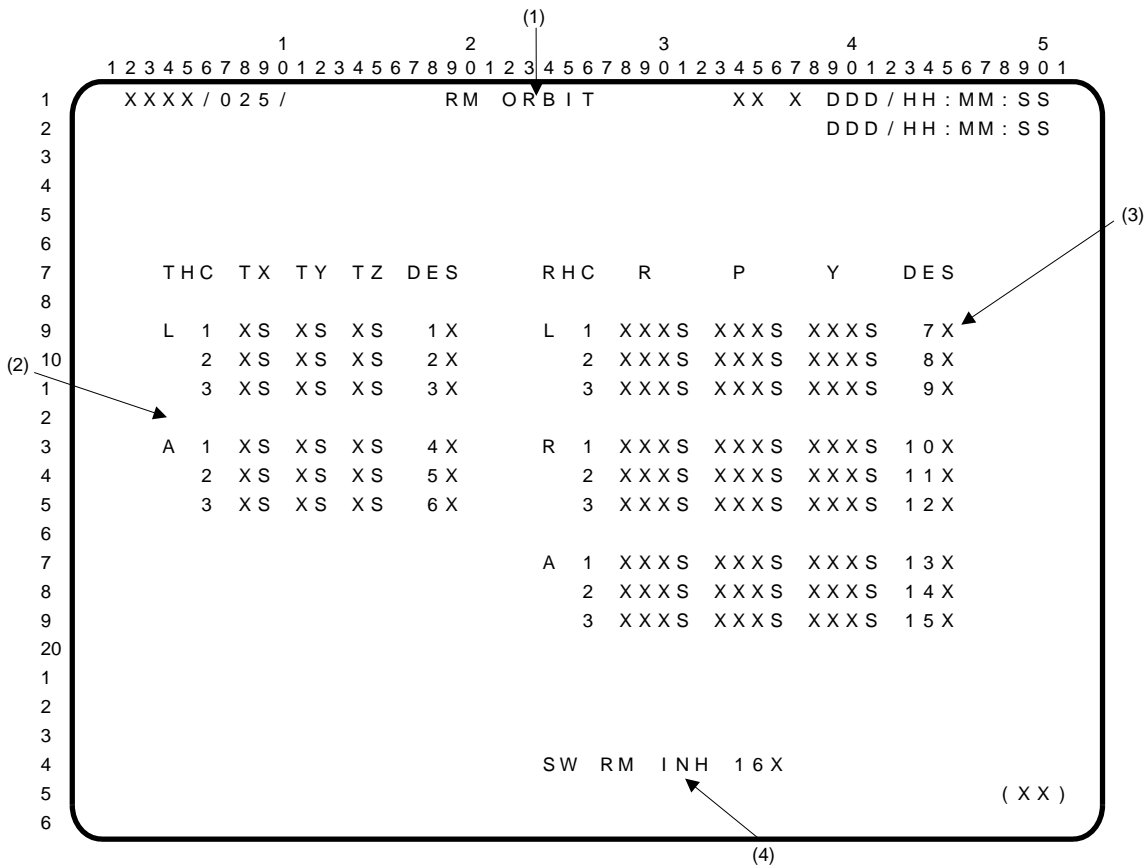

- (1) RM ORBIT display. A GNC specialist function (SPEC 25) available in OPS 2. Includes means to monitor and control the selection filters for the Translational and Rotational Hand Controllers (THC and RHC), and to inhibit/enable Switch Redundancy Management (SW RM).
- (2)\* Commands from the left (L) and aft (A) THC transducers are displayed as a '+' or '-' (in controller axes) under TX, TY, or TZ, depending on the direction of THC deflection. A blank indicates no sensed command.
- (3) RHC left (L), right (R), and aft (A) commands are displayed in percent of full deflection. The '+' and '-' outputs are displayed as 'R' and 'L', respectively, for RHC roll and yaw commands, and 'U' and 'D', respectively, for RHC pitch commands. The directions are referenced to the controller axes. A '00' indicates no sensed command.

Status indicators next to each command display are driven as a blank for normal, 'M' for missing data, '?' for a dilemma condition, and '↓' for RM or manual deselection.

Items 1 thru 15 are used to manually select and deselect the THC and RHC commands to be used by their associated selection filters. Repeatedly executing an item alternately results in selection and deselection. An '\*' next to the item number signifies deselection. SEL/DES status is maintained across OPS transitions.

- (4) Item 16 is a toggle item entry that allows the crew to inhibit the GNC Switch RM. When executed, switch outputs are no longer accepted by the Switch RM processor (selection filter). Additionally, the Switch RM Processor output is "frozen" as a constant output until item 16 is executed again (toggle inhibit off). Contacts which had been deselected prior to the inhibit action are not put back into the selection filter when this item number is executed. An '\*' is displayed after the item number to indicate when the inhibit is in effect. The first time the display is called, the Switch RM will be enabled (i.e., no '\*'), and thereafter will reflect the crew inputs.

RM ORBIT (Cont):

\*PROGRAM NOTES

- (2) AFT THC Data Display. The physical orientation (rotated 90 degrees clockwise) of the AFT THC causes crew commands to be displayed as follows:

<u>THC CMD</u>	<u>TX</u>	<u>TY</u>	<u>TZ</u>
PUSH	+		
PULL	-		
DOWN		+	
UP		-	
STBD			+
PORT			-

	1										2										3										4										5									
	1	2	3	4	5	6	7	8	9	0	1	2	3	4	5	6	7	8	9	0	1	2	3	4	5	6	7	8	9	0	1	2	3	4	5	6	7	8	9	0	1	2	3	4	5	6	7	8	9	0
1	XXXX / 033 /										REL NAV										XX X DDD / HH : MM : SS																													
2	RNDZ NAV ENA 1X										SV UPDATE										DDD / HH : MM : SS																													
3	KU ANT ENA 2X										POS XX XX										AVG G ON 5X																													
4	MEAS ENA 3X										VEL XX XX																				GPS																			
5	NAV										RR XXXX																				STAT P 1σ DES																			
6	SV SEL 4 XXXX										RNG XXXX XXX										RNG XXXX XXXS										1S XXXX XXXXX31X																			
7	RNG XXXX XXX										RNG XXXX XXXS										2S XXXX XXXXX32X																													
8	Ṙ ±XXXX XX										Ṙ ±XXXX XXS										3S XXXX XXXXX33X																													
9	θ XXX XX										EL ±XXX XS																				SV TRANSFER																			
10	Y ±XX XX										AZ ±XXX XS																				FLTR MINUS PROP																			
1	Ÿ ±XXX X										ωP ±XX XS																				POS XX XX																			
2	NODE XX : XX : XX										ωR ±XX XS																				VEL XX XX																			
3	FILTER																														FLTR TO PROP 8X																			
4	S TRK 12X RR 13X COAS 14X																														PROP TO FLTR 9X																			
5	STAT XXXXXXXXXXXX XXXX X ±X X																														ORB TO TGT 10X																			
6	FLTR UPDATE 15 XXX Y ±X X																														TGT TO ORB 11X																			
7	COVAR REINIT 16X																														EDIT OVRD																			
8	RESID										RATIO ACPT REJ										AUT INH FOR																													
9	RNG ±XX XX X X XXX XXS																				17X 18X 19X																													
20	Ṙ ±XX XX X X XXX XXS																				20X 21X 22X																													
1	V / EL / Y ±X XX X X XXX XXS																				23X 24X 25X																													
2	H / AZ / X ±X XX X X XXX XXS																																																	
3	GPS X ±XXX XX X XS																				4 2XS 4 3X 4 4X																													
4	X ±XXX XX X XS																																																	
5																																																		
6																																																		

The REL NAV display is a GNC specialist function (SPEC 33) available in OPS 2 which provides data and controls for rendezvous navigation operations, thrust monitoring, state vector management, and Ku-band antenna enabling.

### PARAMETER CHARACTERISTICS

CRT NAME	UNITS	DISPLAYED RANGE	STATUS INDICATORS				
			M	?	↑	↓	
[1] SV UPDATE: POS VEL	kft ft/sec	Full Range Full Range					
NAV: SV SEL	text	'PROP' or 'FLTR'					
RNG [2]	kft	Full Range					
R [2] [3]	ft/sec	Full Range					
θ [2]	deg	0 to 360					
Y [2] [4]	kft	Full Range					
Ÿ [2] [4]	ft/sec	Full Range					
NODE	time	hr/min/sec					
RR: [5]	text	See Remarks					
RNG	kft	Full Range	M				↓
Ṙ [3]	ft/sec	Full Range	M				↓
EL [6]	deg	-90 to +90	M				↓
AZ [7]	deg	-180 to +180	M				↓
ωP [6]	mr/sec	-99.9 to +99.9	M				↓
ωR [7]	mr/sec	-99.9 to +99.9	M				↓
SV TRANSFER: FLTR MINUS PROP POS VEL [8]	kft ft/sec	Full Range Full Range					
FILTER: STAT [9]	text	See Remarks					
OFFSET X/Y [10]	deg	Full Range					
RESID: RNG	kft	Full Range					
R	ft/sec	Full Range					
V/EL/Y	deg	Full Range					
H/AZ/X	deg	Full Range					
GPS: P	kft	Full Range					
V	ft/sec	Full Range					
RATIO [2] [11]		See Remarks					↓
MARK HIST: ACPT [12]		See Remarks					
REJ [12]		See Remarks					
GPS: STAT [13]	text	See Remarks					
P1σ [14]		See Remarks					

REL NAV (Cont):

REMARKS

- [1] The POS and VEL data fields show the changes made to the position and velocity state vectors by the rendezvous nav filter between the last and current computation cycle.
- [2] These parameters will be blanked if RNDZ NAV is not enabled.
- [3] Sign convention is positive for opening rate, negative for closing rate.
- [4] Positive sense for  $Y$  and  $\dot{Y}$  is along the negative angular momentum vector of the target.
- [5] The Radar System (RR) status field displays 'COMM' when the mode switch (S13) is in the COMM position or it displays 'GPC', 'GDSDG', 'ATRK', or 'MSLW'; reflecting the position of the Ku-band rotary switch (S7). The S7 switch position indications are, however, overridden by 'STST' when self-test is in progress.
- [6] The  $\omega_P$  and EL data fields display pitch inertial angle rate and pitch position (elevation), respectively. Positive sense for each is antenna motion toward the +X orbiter axis.
- [7] The  $\omega_R$  and AZ data fields display roll inertial angle rate and roll position (azimuth), respectively. Positive sense for each is antenna motion toward the -Y orbiter axis.
- [8] FILTER MINUS PROP POS and VEL data indicate the difference between the propagated and filtered state vectors. Once the NAV filter has converged, these parameters can be used to determine when to update the propagated state with the filtered state.
- [9] The STAT field is blank or displays 'NO TARGET', 'FALSE TRK', 'OUT FOV', or 'HI RATE' to indicate the status of the Star Tracker (-Y or -Z) currently selected to the Target Track mode on the S TRK/COAS CNTL display. The secondary status field displays 'BITE' when a failure has been detected for the selected Star Tracker.
- [10] OFFSET data represent the displacement of the target being tracked by the -Z Star Tracker in the -Z COAS FOV. This field is blank except when the -Z STAR TRK or TGT TRK mode (item 4 or 6) on the S TRK COAS CNTL display is selected.
- [11] Residual (RESID) data are the calculated difference between the NAV estimate of the relative position of the orbiter and target and the observed (sensor) measurement. RATIO data are computed by rendezvous navigation software and used for editing bad data. The RATIO data field will be blank if valid data are not presented to the filter. Sensor data are used to update the state vector and covariance matrix if they pass the residual edit test, but RESID and RATIO data are displayed whether or not this test is passed. These data are blanked any time RNDZ NAV is inhibited.
- [12] MARK HIST data reflect the number of NAV marks which have been accepted (ACPT)/rejected (REJ) by the NAV filter for each data type. A '↓' is driven in the REJ column when an I-loaded number of sequential marks is rejected and removed when the mark is forced or an I-loaded number of sequential acceptable marks occurs. The ACPT/REJ counters are reset to zero when a state vector (target or orbiter) is changed (or transferred via item 9, 10, or 11), a covariance matrix is reinitialized (item 16), rendezvous navigation is enabled (item 1), another sensor is selected (item 12, 13, or 14), or after a dual or single engine OMS burn (an RCS translation will not exceed the threshold).
- [13] The STAT field displays one of the messages in the following table to indicate the status of each GPS receiver.



REL NAV (Cont):

Display	Message Description
NI	Receiver is not installed
M	Communication fault
BIT	Receiver Built-In-Test in progress
RPF	Receiver processor failure
BATT	GPS battery low
DGF	GPS data good failure
(blank)	Nominal operation – No GPS related anomaly

- [14]** The one sigma position error (in feet) based on the receiver Figure of Merit (FOM) and labeled as 'P 1 $\sigma$ ' is presented for each installed GPS receiver. The applications software will provide an integer from 0 to 9 which shall be converted to display a one sigma standard position error in feet as indicated below:

FOM Integer	Position error (P), one sigma (1 $\sigma$ ) to be displayed (feet)
0	(blank)
1	75
2	175
3	250
4	325
5	650
6	1650
7	3275
8	16400
9	99999

ITEM ENTRY CHARACTERISTICS

- ITEMS 1 thru 3      RNDZ NAV ENA/KU ANT ENA/MEAS ENA – used to alternately enable/disable rendezvous navigation software, enable/inhibit GNC Angle Pointing data ICC between GNC and SM major functions and enable/inhibit navigation from incorporating external sensor measurements (RR, ST, COAS) in MM202. An '\*' is displayed after each item when it is enabled and each item/function is disabled/inhibited when the display is first called. Item 3 is legal only in MM202 and when rendezvous navigation is enabled. Upon return to MM201, this item is set to inhibit.
- ITEM 4              SV SEL – used to control the source of relative state data. 'PROP' is displayed for a navigated state vector that is not updated by the RNDZ NAV filter. 'FLTR' is displayed when the state vector being used incorporates RNDZ NAV filter data. This display is initialized to 'PROP'.
- ITEM 5              AVG G ON – used to initiate/terminate powered flight navigation for thrust monitoring (MM201 only). An '\*' is displayed next to the item when powered flight navigation is enabled/on. It is ON in MM202 whenever the display is called and is initialized ON each time MM201 is entered.

REL NAV (Cont):

- ITEMS 8 thru 11 SV TRANSFER – used to transfer and overwrite state vectors, FLTR TO PROP, PROP TO FLTR, ORB TO TGT, and TGT TO ORB, respectively. An '\*' is displayed next to the item when it is executed and remains for one NAV cycle while the transfer is in progress. These items are mutually exclusive; execution of any of these items while a transfer is in progress is illegal. In addition, these items are legal only when rendezvous navigation (item 1) is enabled. Also, items 9, 10, and 11 cause a covariance matrix reinitialization when executed.
- ITEMS 12 thru 14 S TRK/RR/COAS – used to select the angle sensors for rendezvous navigation. Upon initial display callup, S TRK is selected ('\*' at item 12). These items are mutually exclusive and subsequent selection of a different item deselects the old item and moves the '\*' from the old to the new selection.
- ITEM 15 FLTR UPDATE – allows the crew to change which vehicle state is to be filtered. The FLTR UPDATE Item Entry is a toggle that switches from either the orbiter state to be filtered, or the target state to be filtered. The FLTR UPDATE Item Entry (Item 15) shall be valid only if rendezvous navigation (Item 1) is OFF; if an Item 15 is requested while rendezvous navigation (Item 1) is enabled, then an 'ILLEGAL ENTRY' message shall be generated. The 'XXX' field by Item 15 shall be either 'ORB' or 'TGT'. FLTR UPDATE is initialized to the pre-mission defined I-Load value upon entry to OPS 2, and shall be restored to the pre-mission defined I-Load value whenever the GN&C OPS 2 overlay occurs.
- ITEM 16 COVAR REINIT – used to reinitialize the covariance matrix. An '\*' is displayed next to this item for one NAV cycle while the covariance matrix is being reinitialized. If rendezvous navigation is not enabled, execution of this item is illegal. Covariance matrix is also reinitialized each time item 1 (RNDZ NAV) is enabled or item 9, 10, or 11 is executed.
- ITEMS 17 thru 25 EDIT OVRD – used to select the auto (AUT), inhibit (INH), or force (FOR) option for range (RNG), range rate (R), and angle (V/EL/Y) data utilization in the NAV filter. Only one option at a time can be selected for each parameter set (i.e., RNG, R, V/EL/Y) and that option is indicated by an '\*' under AUT, INH, or FOR. The INH option is automatically selected for all three parameter sets ('\*' next to items 18, 21, and 24) when the display is initially called up and reflects crew selection thereafter.
- The AUT option allows automatic processing of data in the NAV filter. The INH option inhibits data from being used by the filter to update the state vector or to increment the reject counter but allows these data to be used to generate residual and ratio data for display. The FOR option causes the edit test criterion to be relaxed, allowing data to be processed when the current residual passes the new edit test. (For angles from COAS marks, the FOR option incorporates the most recent COAS mark taken within the last 2 minute period.) The FOR option stays in effect only for the next data point after which control reverts ('\*' moves) to the previously executed option (AUT or INH).
- ITEMS 31 thru 33 Deselected Receiver – Item Entries 31, 32, and 33 provide the capability for each GPS receiver to be deselected or reselected (toggle) for use by the GPS selection filter. Deselection is indicated by an asterisk '\*' adjacent to the DES item number. A blank next to a DES item number indicates that the associated receiver has not been deselected (either initial value or reselection).
- If a GPS receiver is not installed, then execution of the associated Item Entry shall result in an 'ILLEGAL ENTRY' message being generated.

REL NAV (Cont):

ITEMS 42 thru 44

Items 42, 43, and 44 set the GPS to Navigation Auto/Inhibit command and the GPS to Navigation Force command. Executing Item 42 (GPS to Navigation Auto/Inhibit command is set to 'AUTO') allows the navigation filter state to be automatically reset/updated with the selected GPS state (when available) every I-Load specified time interval while in GN&C Major Mode 201 (automatic 'AUTO' reset/update of the navigation filter state is not permitted in Major Mode 202). Executing Item 43 (GPS to Navigation Auto/Inhibit command is set to 'INHIBIT') inhibits the resetting of the navigation filter state with the selected GPS state. Items 42 and 43 are mutually exclusive.

Executing Item 44 (GPS to Navigation Force command is set to 'FORCE') forces the navigation filter state to be automatically reset/updated with the selected GPS state (when available) on the navigation cycle, the 'FORCE' command taking precedence over the setting of the GPS to Navigation Auto/Inhibit command on that cycle. Navigation Force command to 'FORCE' is permitted in both Major Mode 201 and 202. While the FORCE command is being executed, the setting of the GPS to Navigation Auto/Inhibit command remains as set by the crew. The 'FORCE' command is removed by navigation after the navigation reset is executed, so that the setting of the GPS to Navigation Auto/Inhibit command again controls the resetting of the navigation state with the selected GPS state on subsequent navigation cycles. Note that the 'FORCE' is a one-time force.

```

1 2 3 4 5 6 7 8 9 0 1 2 3 4 5 6 7 8 9 0 1 2 3 4 5 6 7 8 9 0 1 2 3 4 5 6 7 8 9 0 1
1 XXXX / 034 / ORBIT TGT XX X DDD / HH : MM : SS
2 DDD / HH : MM : SS
3 MNVR TIG ΔVX ΔVY ΔVZ ΔVT
4 XX X XXX / XX : XX : XX ±XXX . X ±XX . X ±XX . X ±XXX . X
5 PRED MATCH = XXXXXXXX
6
7 INPUTS CONTROLS
8 1 TGT NO XX T2 TO T1 25
9 2 T1 TIG XXX / XX : XX : XX XXXX 26
10 6 EL XXX . XX COMPUTE T1 28X
1 7 ΔX / DNRN [±]XXX . XX COMPUTE T2 29X
2 8 ΔY [±]XXX . XX
3 9 ΔZ / ΔH [±]XXX . XX
4 10 ΔẊ [±]XXX . XX
5 11 ΔẎ [±]XXX . XX
6 12 Δẏ [±]XXX . XX
7 13 T2 TIG XXX / XX : XX : XX
8 17 ΔT [±]XXX . X
9 18 ΔX [±]XXX . XX
20 19 ΔY [±]XXX . XX
1 20 ΔZ [±]XXX . XX
2 21 BASE TIME XXX / XX : XX : XX
3
4
5
6

```

```

ORBITER STATE
XXX / XX : XX : XX . XXX
X ±XXXXXX . XXX
Y ±XXXXXX . XXX
Z ±XXXXXX . XXX
VX ±XX . XXXXXX
VY ±XX . XXXXXX
VZ ±XX . XXXXXX

```

Orbit Targeting (ORBIT TGT) is a GNC specialist function (SPEC 34) available in OPS 2. It is used to predict and choose a two-impulse maneuver sequence prior to and during rendezvous or during the execution of a standoff type maneuver. On initial callup, the MNVR, PRED MATCH, and INPUTS displays show zeroes (except items 21 thru 24 which are initialized to I-loaded values) and thereafter these fields reflect crew inputs.

**PARAMETER CHARACTERISTICS**

CRT NAME	UNITS	DISPLAYED RANGE	STATUS INDICATORS				
			M	?	↑	↓	
MNVR: XX X TIG ΔVX ΔVY, ΔVZ ΔVT PRED MATCH	[1] [2] [3] time [4] ft/sec [4] ft/sec [5] ft/sec [6] ft	1 to 40 blank or '*' day/hr/min/sec -999.9 to +999.9 -99.9 to +99.9 -999.9 to +999.9 0 to 9,999,999					
INPUTS: TGT NO T1 TIG EL ΔX/DNRNG, ΔY, ΔZ/ΔH ΔX, ΔY, ΔZ T2 TIG ΔT ΔX, ΔY, ΔZ BASE TIME	[1] [7] time [8] deg [9] kft [9] ft/sec [10] time [11] min [12] kft [13] time	1-40 day/hr/min/sec 000.0 to 359.99 -999.99 to +999.99 -999.99 to +999.99 day/hr/min/sec -300 to +300 -999.99 to +999.99 day/hr/min/sec					
ORBITER STATE: XXX/XX:XX:XX.XXX X,Y,Z VX,VY,VZ	[14] time [15] kft [16] kft/s	day/hr/min/sec -99999.999 to 99999.999 -99.999999 to 99.999999					

ORBIT TGT (Cont):

REMARKS

- [1] Target set number on which the maneuver is based.
- [2] '\*\*' indicates that the TIG is in the past.
- [3] The impulsive ignition time of the maneuver in MET.
- [4] LVLH external delta V components of each maneuver.
- [5] Total delta V of the maneuver.
- [6] Distance to which the on-orbit predictor was matched in targeting.
- [7] Impulsive ignition time (MET) of first maneuver of a two-impulse set. If T1 TIG is in the past, a COMPUTE T1 (item 28) will cause T1 TIG to be set to current time plus an I-load  $\Delta$  time and the targeting performed using the navigated state.
- [8] Elevation angle measured from the orbiter, positive up, to the target. If  $EL \neq 0$  then an elevation angle search is performed and the TIG determined; if  $EL = 0$ , input TIG is used.
- [9] These data show the orbiter relative position and velocity at T1 TIG.
- [10] Impulsive ignition time (MET) of the second maneuver of the two-impulse set. If  $\Delta T$  is not zero, a COMPUTE T1 (item 28) will cause T2 TIG to be calculated and displayed in these locations along with targeting outputs. If the T2 TIG is in the past when a COMPUTE T2 (item 29) is done, it will be reset to current time plus an I-load  $\Delta$  time and the maneuver is computed using the navigated state vector at the new T2 TIG time.
- [11] Transfer time between first maneuver time (T1 TIG) and second maneuver time (T2 TIG). If  $\Delta T$  is blank, it will be computed based on the T2 and T1 TIG times when a COMPUTE T1 is executed. If  $\Delta T$  is negative on execution of a COMPUTE T1, both  $\Delta T$  and T2 TIG will be computed based on an algorithm used in orthogonal braking and will be displayed.
- [12] Desired orbiter relative position at T2 TIG.
- [13] Time from which subsequent maneuvers are calculated.
- [14] Current Greenwich Meridian Time (GMT).
- [15] Current M50 orbiter position.
- [16] Current M50 orbiter velocity.

ITEM ENTRY CHARACTERISTICS

- ITEM 25                      Transfers the T2 TIG of the previous maneuver sequence to the T1 TIG slot of the current maneuver sequence. While either T1 or T2 computations are in progress, entry of any item on the display is illegal.
- NOTE: This capability allows sequential execution of two-impulse targeting sets where only the first maneuver is executed and it is desired to target a new two-impulse set with the T1 maneuver being at the previously defined T2 TIG.
- ITEM 26                      Loads data from the INPUTS data field (except item 1) into the associated data slots for use by the targeting software. The word 'LOAD' will begin flashing next to item 26 when an item 2 thru 24 entry is made. 'LOAD' will continue to be displayed, but flashing will cease when item 26 is executed. Execution of item 26 also overwrites the previous (or I-load) target set values so that the new values will appear if that maneuver set is again requested via item 1.
- NOTE: Item 26 is illegal unless any of items 2 thru 24 have been changed.

ITEM ENTRY CHARACTERISTICS (Cont):

ITEM 28                      Calculates the first maneuver solution of the specified two-impulse set. The calculated results are displayed in the MNVR section of this display and are also output to guidance for display on the ORBIT MNVR EXEC display. Also, all of the items in the INPUTS section of the display will fill in. An '\*' will be driven beside item 28 until the calculations are complete. As soon as the T1 computation is complete, the GNC CRT timer will start counting down on the next unexecuted maneuver TIG.

NOTE: Item 28 is illegal if RNDZ NAV is not enabled or if no target set has been selected.

ITEM 29                      Calculates second maneuver of a two-impulse set. An '\*' is displayed until computations are complete. The maneuver solution computed is that required to null relative velocity at T2 TIG. If T2 TIG is in the past, it is set to current time plus a predefined delta time and the maneuver is computed using the navigated state vector. When the calculations are complete, the required  $\Delta V$ s are displayed in the MNVR section of this display and are passed to guidance awaiting execution. Also, the GNC CRT timer will start counting down to the next unexecuted maneuver TIG.

NOTE: While either T1 or T2 computations (item 28 or 29) are in progress, entry of any item on the display is illegal.

Item 29 is illegal if RNDZ NAV is not enabled or if no target set has been selected.

		(1)										GPS STATUS										XX X DDD / HH : MM : SS									
		1 2 3 4 5 6 7 8 9 0 1										2 3 4 5 6 7 8 9 0 1										3 4 5 6 7 8 9 0 1									
1		XXXX / 055 /																													
2																						DDD / HH : MM : SS									
3		I / O	10	X	GPS1 S	GPS2 S	GPS3 S																								
(2) 4	→	STAT			XXXX	XXXX	XXXX											GPS MINUS NAV ← (16)													
(3) 5	→	MODE			XXXX	XXXX	XXXX											Δ H ±XXXXXXXX Δ Ĥ ±XXX.XX													
(4) 6	→	S / TEST			11XS	12XS	13XS											Δ DR ±XXXXXXXX Δ ĎR ±XXX.XX													
(5) 7	→	INIT			14X	15X	16X											Δ CR ±XXXXXXXX Δ ĆR ±XXX.XX													
(6) 8	→	NAV			17X	18X	19X																								
(7) 9	→	RESTART			20X	21X	22X											X LAT X LON ALT ← (17)													
10																		XX.XX XXX.XX XXX.XXXX													
(9) 1	→	GDOP			XX	XX	XX																								
(10) 2	→	DG FAIL			S	S	S											AUT INH FOR													
(11) 3	→	DES RCVR			26X	27X	28X											GPS TO G&C S32X 33X 34X ← (18)													
(12) 4	→	QA OVRD			29XS	30XS	31XS											GPS TO NAV S35X 36X 37X ← (19)													
(13) 5	→	SF CAND			X	X	X											METERING OVERRIDE 38X ← (20)													
(14) 6	→	QA1 P 1			σXXXXXXXX	XXXXXXXX	XXXXXXXX											GPS TIME ADJUST ENA 39X ← (23)													
7		QA2 POS			X.XX	X.XX	X.XX											SATELLITES													
8		VEL			X.XX	X.XX	X.XX											TRKD C1 C2 C3 C4 C5 C6 ← (21)													
9		QA3 POS			X.XXS	X.XXS	X.XXS											GPS1 XX XX XX XX XX XX													
20		VEL			X.XXS	X.XXS	X.XXS											GPS2 XX XX XX XX XX XX													
1					1-2	2-3	3-1											GPS3 XX XX XX XX XX XX													
2		QA4 POS			X.XXS	X.XXS	X.XXS																								
3		VEL			X.XXS	X.XXS	X.XXS											DES 43 XX XX XX XX ← (22)													
(15) 4	→	XXX.X			LAST SEL	FIL	UPDATE											XX XX XX XX													
5																															
6																															

The Global Positioning System STATUS display (SPEC 55) provides the crew with the capability to monitor and control GPS operations. It is available in GNC OPS 1, 2, 3, 6, 8, and 9. All information associated with receivers which are not installed shall be blanked with the exception of 'NI' (Not Installed) being displayed in the appropriate receiver status fields. Execution of item entries associated with the uninstalled receivers shall generate an 'ILLEGAL ENTRY' message.

NOTE: Items 1 thru 9 are not used and execution of these items will result in an 'ILLEGAL ENTRY' message.

(1) GPS1, GPS2, GPS3. Item 10 provides the capability to control GPS receiver I/O in GNC OPS 9. 'Item 10+X EXEC' (where X=0, 1, or 2) controls the execution of one of the following three GPS receiver I/O options:

- '0' Disabled GPS receiver I/O, indicated by a '0' beside item 10. When in GNC OPS 9, all GPS cyclical processing functions shall be suspended.
- '1' 6.25 Hz non-commfaultable GPS to GPC input only, indicated by an '1' beside item 10.
- '2' Flight GPS I/O of 1.04 Hz GPS to GPC input and 6.25 Hz GPC to GPS output indicated by a '2' beside item 10.

GPS I/O shall initially be disabled in GNC OPS 9 and a '0' shall be driven beside item 10. If no GPS receivers are installed, then GPS receiver I/O is disabled in all OPS and attempts to execute item 10 shall cause an 'ILLEGAL ENTRY' message. Otherwise, on the first execution of 'item 10+1 EXEC', a '1' is driven beside item 10; on the second item 10 execution, the only values can be 'item 10+0 EXEC' or 'item 10+2 EXEC'. An 'item 10+2 EXEC' will enable flight I/O and drive a '2' beside the item. When in I/O state 1 or 2 and 'item 10+0 EXEC' will return GPS I/O to the disabled state and display a '0' beside the item. The legal sequence may be repeated indefinitely in GNC OPS 9.

The GPS1, GPS2, and GPS3 column headers identify the item entries and display parameters associated with a GPS receiver. For the single string GPS configuration, an '\*' will be displayed next to the GPS column header(s) in the parameter status field if the receiver's state is selected. When three GPS receivers are installed, an 'Blank' will be displayed in the column header of every GPS eligible for selection.

The corresponding fields for uninstalled receivers will remain blank.

GPS STATUS (Cont):

- (2) STAT. This field displays the status of each GPS receiver.

Display	Message Description
NI	Receiver is not installed
M	Communication fault
BIT	Receiver Built-In-Test in progress
RPF	Receiver processor failure
BATT	GPS battery low
DGF	GPS data good failure
(blank)	Nominal operation – No GPS related anomaly

If a receiver processor failure occurs, a CLASS 3 alarm will be annunciated by GAX for all operational sequences, except for OPS 9. 'RPF' and 'M' will be displayed double overbright. STAT is active regardless of whether the corresponding receiver is installed.

- (3) MODE. This field displays the current operating mode of the receiver.

Display	Message Description
INIT	Initialization mode
TEST	Self-Test mode
INS	Inertial Navigation System submode
PVA	Position, Velocity, Acceleration submode
Site	3-character vehicle location mnemonic
(blank)	Receiver is not in an operating mode

If the receiver is reporting prelaunch standby or stationary mode, a three-character mnemonic representing the last crew-selected IMU calibration site or landing site is displayed in the mode field (prior to launch the IMU calibration site, as selected on SPEC 104, is displayed; post liftoff, the first three characters of the last selected runway on SPEC 50 are displayed). When the receiver is reporting prelaunch standby or stationary mode, the site location will supercede 'INS' or 'PVA' but not 'INIT' or 'TEST'. The receiver will normally be in prelaunch standby nav submode only in MM901 and MM101.

The latest valid receiver mode is displayed. If the receiver is not installed, the displayed mode, which is initialized to blank at an OPS transition, will remain blank. If the receiver is powered off or failed at an OPS transition, the displayed mode will remain blank until the receiver enters a valid mode. Once the receiver is in a valid mode, the displayed mode will not be blank for that OPS, since the latest valid mode remains on the display, even if the receiver is powered off or if it fails. If the mode field is blank, the STAT parameter (2) should be referenced for further information. During a communications fault the receiver MODE indication will remain in the operating mode last displayed.



## GPS STATUS (Cont):

- (4)** S/TEST. Items 11, 12, and 13 provide the capability to command a self-test for the associated GPS receiver. An '\*' shall be displayed while self-test is being commanded. 'BIT' will be driven in the receiver status field while the self-test is in progress. 'BIT' will be removed from the receiver status field on completion of the self-test. The receiver will remain in S/TEST upon completion of S/TEST until commanded to INIT or NAV mode, at which time the '\*' will be removed. Reentering an item to command an S/TEST while the receiver is already in S/TEST will not result in a restart of the S/TEST and will result in an 'ILLEGAL ENTRY' message. A new S/TEST can be commanded only when a receiver is in INIT or NAV mode. The items of **(4)**, **(5)**, and **(6)** for an individual receiver are mutually exclusive.

A status indicator provides feedback on the progress and completion of the commanded self-test. The status indicator for each receiver is initially an '↑' and will be blanked while a self-test is in progress. Upon completion of the self-test, an '↑' will be shown if the self-test completed successfully or a "↓" will be shown if the receiver failed the self-test.

The up or down arrow will remain shown on the display until the receiver enters either INIT or NAV mode.

For uninstalled receivers, executing item 11, 12, or 13 will result in an 'ILLEGAL ENTRY' message.

- (5)** INIT. Items 14, 15, and 16 provide the capability to command the initialization of a GPS receiver. An '\*' shall be displayed while initialization operations are in progress and while the receiver remains in the INIT mode. The receiver gives no indication when it completes the initialization mode. Commanding INIT mode while the receiver is in the INIT mode will result in an 'ILLEGAL ENTRY' message. The receiver will remain in the INIT mode until commanded to S/TEST or NAV mode, at which time the '\*' will be removed. The items of **(4)**, **(5)**, and **(6)** for an individual receiver are mutually exclusive.

For uninstalled receivers, executing item 14, 15, or 16 will result in an 'ILLEGAL ENTRY' message.

- (6)** NAV. Items 17, 18, and 19 provide the capability to mode the GPS receiver to the navigation mode. An '\*' shall be displayed once the receiver is commanded to the navigation mode. The receiver will remain in the NAV mode until commanded to S/TEST or INIT mode, at which time the '\*' will be removed. Commanding NAV mode while the receiver is in NAV mode will result in an 'ILLEGAL ENTRY' message. If a receiver is commanded to NAV before a commanded S/TEST or INIT has been completed, the receiver will transition to the NAV mode when it completes the S/TEST or INIT mode. The items of **(4)**, **(5)**, and **(6)** for an individual receiver are mutually exclusive.

For uninstalled receivers, executing item 17, 18, or 19 will result in an 'ILLEGAL ENTRY' message.

- (7)** RESTART. Items 20, 21, and 22 provide the capability to command each GPS receiver to restart its navigation filter. This option is available only when the receiver is in the INS NAV submode, indicated by 'INS' being displayed in the MODE field. An 'ILLEGAL ENTRY' message will be generated if the RESTART command is entered and the receiver is not in the INS NAV submode. An '\*' shall be displayed in the associated item field while the filter restart operations are in progress for that receiver and the '\*' will be removed upon receiver completion of the restart. If the receiver is in the S/TEST or INIT modes, commanding a receiver filter restart will result in an 'ILLEGAL ENTRY' message.

For uninstalled receivers, executing item 20, 21, or 22 will result in an 'ILLEGAL ENTRY' message.

- (8)** Intentionally Omitted

## GPS STATUS (Cont):

- (9)** GDOP. This field displays the geometric dilution of precision (GDOP) computed in each GPS receiver. GDOP is a function of GPS satellite geometry. Displayed values of GDOP range from 1 to 15, with a smaller number indicating a more favorable satellite geometry. The GDOP data will be blank: (1) in GN&C OPS 9, OPS 1, MM601 when it is determined by the GPS SOP to be static; and (2) in GN&C OPS 2, OPS 3, OPS 8, MM602 and MM603 when GPS data is determined by the GPS RCVR State Proc to be invalid.

The corresponding fields for uninstalled receivers will remain blank.

- (10)** DG FAIL. This field indicates whether the receiver data used by the GPS receiver state processing principal function are valid. If the receiver is in the navigation mode and the receiver data are invalid, or the receiver state time tag is more than 3.84 seconds older than the current navigation filter state time tag, a '↓' is displayed in double overbright; otherwise the status field is blanked. The status field is also blanked if the receiver is in the TEST or INIT mode.

The corresponding fields for uninstalled receivers will remain blank. All fields are blanked in OPS 9.

- (11)** DES RCVR. Items 26, 27, and 28 provide the capability for each receiver to be deselected or reselected (toggle) for use by the GPS selection filter. Deselection is indicated by an "\*" adjacent to the DES item number. A blank indicates that the associated receiver has not been deselected.

Execution of item entries 26, 27, or 28 in GN&C OPS 1, OPS 9, or MM601 will result in an 'ILLEGAL ENTRY' message. GPS receivers can be deselected or reselected from HORIZ SIT DISP in OPS 3 and MM602 and 603 (3 GPS receivers installed). In OPS 2 a receiver can be deselected or reselected from REL NAV DISP. Deselection or reselection will carry over OPS transitions.

- (12)** QA OVERRIDE. Items 29, 30, and 31 are used to force a given receiver's state to be a candidate for GPS state vector selection even though that state may have failed any of three quality assessments (indicated by a down arrow next to one or more of the QA1, QA3, and QA4 checks described in **(14)**). An "\*" is displayed if the override has been selected. QA data continues to be calculated for a GPS even if it has been selected for a QA OVERRIDE. Note that a QA OVERRIDE does not override a receiver-data-good failure on a GPS (see **(2)**) or a crew deselection of a GPS (see **(11)**). In either case, an attempted QA OVERRIDE of that GPS will drive a '↓' in the associated parameter status field, indicating that the QA OVERRIDE command is not being honored. The override applies continuously until it is removed by again executing the item, at which time the parameter field is blanked.

Note that items 29, 30, and 31 will not override a QA4 dilemma and force a given receiver's state to be a candidate for GPS state vector selection.

For uninstalled receivers, executing item 29, 30, or 31 will result in an 'ILLEGAL ENTRY' message.

These parameters are blanked in OPS 9, OPS 1, and MM601.

- (13)** SELECTION FILTER CANDIDATE. An "\*" in the status field indicates that the state for the given receiver is a candidate for GPS state selection. A '↓' indicates that the state for the given receiver is not a candidate for GPS state selection. In order to be a candidate for selection the receiver cannot have been deselected (see **(11)**); must have valid data as indicated by the receiver (see **(10)**); must have passed QA1, QA3, and QA4 quality assessments (see **(14)**) unless the QA override for that receiver (see **(12)**) has been set; or it must have been forced (see **(18)**).

The field will also remain blank in OPS9, OPS 1, and MM601.

The corresponding field for uninstalled receivers will remain blank.

- (14)** QA1, QA2, QA3 and QA4

QA1 P1σ This field displays the Figure of Merit (FOM) or estimate of position error for each receiver. The FOM is related to the error as follows:

## GPS STATUS (Cont):

FOM integer	Position error (P), one sigma ( $1\sigma$ ) [feet]
0	(blank)
1	75
2	175
3	250
4	325
5	650
6	1650
7	3275
8	16400
9	99999

The FOM data from the GPS Receiver State Processing Principal Function will be blank when the receiver is not in NAV mode (i.e., in TEST or INIT mode) or when the GPS NAV data used by the GPS Receiver State Processing Principal Function are not valid. They are blanked in OPS 9, OPS 1, and MM601 when determined by the GPS SOP to be static.

If the FOM exceeds a pre-mission determined I-Load tolerance, a '↓' shall be driven in the appropriate parameter status indicator field next to the displayed FOM value and displayed double overbright. If the receiver state estimate fails the QA1 FOM quality assessment check, it is excluded as a candidate from the GPS state vector selection process, unless forced to be a candidate for selection by the crew ((**13**) and (**18**)), in which case the '↓' remains.

The corresponding fields for uninstalled receivers will remain blank.

QA2 POS & VEL This selection displays the maximum position (POS) and maximum velocity (VEL) residual ratios. The ratios give the crew an indication as to how well the GPS and NAV states agree only and are not used to determine candidacy for GPS state vector selection. The position and velocity residual ratios are computed by differencing the navigation state and the individual GPS state in UVW coordinates, and dividing each of the UVW difference components by a corresponding UVW I-Load derived tolerance.

The calculation of UVW position and velocity QA2 residuals shall be in a coordinate system that is GNC Major Mode dependent. In Modes 304, 305, 602, and 603, the UVW coordinate system shall be an earth relative coordinate system. For all other major modes where these residuals are computed, the UVW coordinate system shall be an inertial coordinate system. The actual QA2 calculations use all six components of position and velocity, but only the maximum position and velocity residual ratio is displayed.

The data are static when the receiver is in the TEST or INIT mode and the display field will be blank in OPS 9, OPS 1, and MM601.

The corresponding fields for uninstalled receivers will be blank for all OPS.

QA3 POS & VEL This section displays the QA3 position (POS) and velocity (VEL) residual ratios. These ratios are computed as follows: (1) The position and velocity differences between the current GPS receiver orbiter state estimate which has been propagated to the current navigation filter time and that receiver's valid state estimate from the previous navigation cycle which has been propagated to the current navigation filter time is computed; (2) the ratios are then computed by dividing the position and velocity differences by pre-mission determined I-Load tolerances. The QA3 test gives the crew an indication of the stability of the receiver position and velocity estimates. The GPS receiver state processing QA3 software tests the vector magnitude of the position and velocity difference against pre-mission determined I-Loads. If the QA3 test for either a position or velocity ratio fails (ratio > 1) that receiver's state is then excluded as a candidate from the GPS state vector selection process, unless forced to be a candidate for selection by the crew ((**12**) and (**18**)). A down arrow, "↓", shall then be displayed next to the associated ratio value for a QA3 test failure. The down arrow is displayed if the failure condition exists, regardless of the state of the QA override discrete or the GPS to G&C FORCE discrete. The down arrow is removed when the failure condition no longer exists. If the QA3 blanking flag for a receiver is ON, the QA3 position and velocity ratios and their corresponding status indicators for that receiver are blanked.

## GPS STATUS (Cont):

The data are static when the receiver is in the TEST or INIT mode and the display field will be blank in OPS 9, OPS 1, and MM601.

The corresponding fields for uninstalled receivers will be blank for all OPS.

QA4 POS & VEL A GPS receiver is available for QA4 processing (receiver to receiver residual ratio calculations) if the receiver data is determined to be valid. Receiver data is valid if its DG FAIL status is showing a blank **(10)** and the receiver is selected **(11)**. However, QA4 failure/dilemma detection will only be performed on receiver which passes QA1 check or has its QA Override set ON. Display of QA4 Ratios and Status Indicators: This section displays the Quality Assessment 4 (QA4) position (POS) and velocity (VEL) residual ratios for comparison of GPS receiver to GPS receiver. Column 1 displays the differences between GPS receiver 1 and 2; column 2 displays the differences between 2 and 3; and column 3 displays the differences between 3 and 1. Data is displayed whenever the receiver data used by the GPS receiver state processing principal function is valid (DG FAIL blank, **(10)**) for both GPS receivers in the associated pair. If data for either GPS receiver in the pair of receivers being compared is invalid, then the QA4 data and the associated status indicators shall be blanked for that pair of receivers.

When receiver state data is valid for only one GPS receiver, the QA4 data and the associated status indicators shall be blanked for all pairs of receivers.

The '↓', is removed when the limit exceedance condition no longer exists for each GPS receiver pair combination or when at least one receiver in a pair combination is deselected, or has failed its QA1 check and its QA Override reset to OFF.

The data is static when the receiver is in the TEST or INIT mode. The display fields shall be blank in GN&C OPS 1, OPS 9, and MM 601.

This section is applicable only when three GPS receivers are installed. For zero or one GPS receiver installed, all QA4 fields shall be blanked.

QA4 Fail: At the three GPS receivers available for QA4 level, if any QA4 receiver to receiver comparisons are failed, and it can be determined which receiver is inconsistent with the remaining two receivers, then that receiver fails QA4 and is excluded as a candidate from the GPS state vector selection process, unless forced to be a candidate by the crew (**(12)** and **(18)**). A down arrow, '↓', shall be displayed to the right of the difference to indicate the two GPS receiver pairs which exceeded the position or velocity difference limit. For example, if GPS receiver 2 were to have failed, then a down arrow, '↓', should appear for pair 1 - 2 data (column 1) and pair 2 - 3 (column 2). The identification of GPS receiver 2 as common to the two columns displaying a down arrow, '↓', would show that GPS receiver 2 has failed the QA4 test. GPS receiver 2 would also show a down arrow, '↓', next to the GPS column header **(1)**. If the number of GPS receivers available for QA4 changes on a later execution cycle to be less than 3, then the QA4 fail indicator is set to OFF (to indicate no failure).

QA4, 3 GPS in Dilemma: At the three GPS receivers available for QA4 level, if all three QA4 receiver to receiver pair comparisons fail, then all three GPS receivers are declared to be in dilemma. When all three GPS receivers are in dilemma, '?' will appear by the GPS column header for all three GPS receivers. The dilemma established at the three GPS receiver level will be reassessed at each subsequent execution cycle as long as there are at least two receivers with valid data for QA4 processing. In a rare scenario where at least two receivers transition from data valid to invalid on the same execution cycle, the three GPS level dilemma established on the prior execution cycle will be latched until either:

If two or more GPS receivers are later available for QA4 processing, and conditions no longer exist for a QA4 dilemma on that execution cycle.

Or, two GPS receivers are deselected.

For a QA4 dilemma, neither the GPS to GNC FORCE command **(18)** nor the QA override **(12)** will override the QA4 dilemma and force a given receiver's state to be a candidate for GPS state vector selection. The crew must resolve the dilemma and then deselect GPS receivers until only a single GPS receiver remains selected.

## GPS STATUS (Cont):

**QA4, 2 GPS in Dilemma:** At the two GPS receivers available for QA4 level, a down arrow, '↓', shall be displayed by the appropriate QA4 ratio if the remaining GPS receiver pair has exceeded the position or velocity difference limit. Both remaining receivers shall be removed from the candidate set for the GPS state vector selection on the current execution cycle and a '?' will appear by the GPS column header of each receiver. If one of the two GPS receivers that were available for QA4 on the prior execution cycle has receiver data transition from valid (on prior cycle) to receiver data invalid, then the prior two GPS level dilemma will remain set until either:

- (15) **TIME SINCE LAST SELECTION FILTER UPDATE.** This field displays the minutes since the last selection of a GPS state by the GPS state vector selection software function. It indicates the time since at least one of the criteria defined in (13) has been satisfied by any receiver. Should the time since the last selection of a GPS state exceed a pre-mission defined value, GAX will annunciate a class 3 message and an alert tone, and the time will be displayed double overbright. The time will be reset to zero at OPS transition, after an on-orbit IPL, when GPS receiver data updates the selected state, and when all three receivers are not available. The field will be blanked until a selected GPS state becomes available.

The field will also be blank in OPS 9, OPS 1, and MM601.

- (16) **GPS MINUS NAV.** This section displays the components of the position and velocity vector differences between the selected GPS state estimate and the orbiter navigation filter state estimate in UVW coordinates: altitude ( $\Delta H$ ), downrange ( $\Delta DR$ ), and crossrange ( $\Delta CR$ ) for both position and velocity. Units are ft and ft/sec for position and velocity, respectively. The data fields are blanked when no GPS state is available.

The field will also be blank in OPS 9, OPS 1, and MM601.

- (17) **GEODETTIC COORDINATES.** This section displays the geodetic coordinates of the selected GPS state: altitude (ALT), latitude (LAT), and longitude (LON). Altitude is displayed in nautical miles. Latitude is displayed in degrees from the equator with an 'N' or 'S' displayed in the field before the LAT title for northern ( $LAT \geq 0$ ) or southern ( $LAT < 0$ ) hemisphere. Longitude is displayed in degrees from the Greenwich meridian with an 'E' or 'W' displayed in the field before the LON title if the orbiter is east ( $LON \geq 0$ ) or west ( $LON < 0$ ) of the Greenwich meridian, respectively. In MM 304, 305, 602, and 603, altitude is displayed with units of kilo-feet.

The data fields are blanked when no GPS state is available. The field will also be blank in OPS 9, OPS 1, and MM601.

- (18) **GPS TO GUIDANCE AND CONTROL (G&C).** Items 32, 33, and 34 set the GPS to Guidance and Control Auto/Inhibit/Force command. An '\*' next to the item number set by the application software represents the selected setting. The three item entries are mutually exclusive. Selecting item 32 ('AUTO') commands the application software to automatically reset/update the user parameter (UPP) state vector with the selected GPS state every navigation cycle (when a selected state is available), rather than resetting the UPP state with the selected navigation filter state. Item 33 ('INHIBIT') inhibits the application software from using the selected GPS state to reset the UPP state. Item 34 sets the command to 'FORCE'. In this setting, the command performs two functions in the application software: (1) it forces the GPS receiver states from all installed receiver states, that are determined by the receiver to have good data (receiver data good is ON) and are not deselected by the crew (item 26, 27, or 28 (DES RCVR)), to be processed by the GPS state selection filter, forcing a selection of a GPS state; and (2) it forces the use of this selected state in resetting the UPP state for guidance. Unlike the GPS to Navigation Force command, which is a one-time force, the GPS to guidance and control 'FORCE' condition remains active until either item 32 or 33 is selected.

If item 32 is executed and no selected GPS state vector is available, the application software will command a '↓' in the status field before the item 32 label. The '↓' will be removed once a selected state becomes available. If item 34 is executed and no selected GPS state is available and all installed receivers are either deselected or indicate that their state data are not good (receiver data good is OFF), the application software will command a '↓' in the status field before the item 32 label. The '↓' will be removed once the state of a receiver which has not been deselected is indicated as good by the receiver, since the GPS to G&C FORCE setting will force a selected state to be made available on that navigation cycle. In preland, if TACAN is not in FORCE, item 32 has been selected, MLS data good, and a selected GPS state is available, the application software will command a '↓' in the parameter status indicator field before

GPS STATUS (Cont):

the item 32 label, indicating to the crew that the processing of MSBLS measurements by the application software and using the MSBLS derived navigation state for guidance has precedence over the “automatic” use of the selected GPS state in providing the state for guidance.

If item 34 has been selected, however, no ‘↓’ will appear in the parameter status indicator field before the item 32 label and the following application software conditions apply:

- (1) The application software will use the selected GPS state (when available) for guidance;
- (2) MSBLS measurements will not be processed by the application software;
- (3) TACAN measurements will be processed if TACAN is in AUTO.

The GPS to Guidance and Control command will initially be set to ‘INHIBIT’. It will also be set to ‘INHIBIT’ at OPS transitions. The GPS to G&C command can also be set on SPEC 50 with the setting there also shown on the GPS STATUS display.

These items will be allowed or not allowed in a given Operational Sequence depending on the value of the GPS\_LOCKOUT I-Load parameter.

GPS\_LOCKOUT DESCRIPTION AND USE

GPS_LOCKOUT VALUE	Description and Use
0	<ul style="list-style-type: none"> <li>• No GPS receivers installed</li> </ul>
1	<ul style="list-style-type: none"> <li>• GPS receivers installed</li> <li>• Capability to use selected GPS state in the onboard system locked out</li> </ul>
2	<ul style="list-style-type: none"> <li>• GPS receivers installed</li> <li>• Use of selected GPS state in the onboard system allowed in OPS 2 and OPS 8</li> </ul>
≥ 3	<ul style="list-style-type: none"> <li>• GPS receivers installed</li> <li>• Use of selected GPS state in the onboard system allowed in OPS 2, OPS 8, and OPS 3</li> </ul>

LEGALITY OF GPS STATUS DISPLAY ITEM ENTRIES WITH DEPENDENCY ON GPS\_LOCKOUT

GPS_LOCKOUT VALUE	0	1	2	≥ 3
GPS_TO_NAV_AI (Items 35 and 36)	I	I	2,8	2,3,8, 602, 603
GPS_TO_NAV_FORCE (Item 37)				
GPS_TO_GC_AIF (Items 32,33,34 Legality)				

“I” indicates ILLEGAL ENTRY

A Number indicates the OPS or MM when the Item Entry is available

**NOTE:** All above item entries are ILLEGAL in OPS 9, OPS 1 and MM601 regardless of the value of GPS\_LOCKOUT

**(19)** GPS TO NAV COMMAND. Items 35, 36, and 37 set the GPS to Navigation Auto/Inhibit command and the GPS to Navigation Force command. While in GN&C MM 201 or OPS 8, executing item 35 (GPS to Navigation Auto/Inhibit command is set to ‘AUTO’) allows the navigation filter state to be automatically reset/updated with the selected GPS state (when available). Automatic ‘AUTO’ reset/update of the navigation filter state is not permitted in MM 202. Automatic updates occur at an I-Load specified time interval. Also, the automatic GPS updates to navigation will be terminated, even though the GPS to Navigation Auto/Inhibit

## GPS STATUS (Cont):

command is in 'AUTO', if the selected GPS residual ratio edit flag is ON, or the time since the selected GPS state was last updated with receiver data is greater than or equal to an I-loaded limit.

While in OPS 3 or OPS 6, executing item 35 (GPS to Navigation Auto/Inhibit command is set to 'AUTO' and MLS measurements not available) allows the navigation filter state to be automatically reset/updated with the selected GPS state (when available). Automatic updates occur at one of two I-Load specified time intervals, depending on whether or not the orbiter is above an I-Loaded altitude for changing GPS update rates. Also, the automatic GPS updates to navigation will be terminated, even though the GPS to Navigation Auto/Inhibit command is in 'AUTO', if the selected GPS residual ratio edit flag is ON, the orbiter is at or below an I loaded lower limit altitude for automatic GPS updates, or the time since the selected GPS state was last updated with receiver data is greater than or equal to an I-Loaded limit. Executing item 36 (GPS to Navigation Auto/Inhibit command is set to 'INHIBIT') inhibits the resetting of the navigation filter state(s) with the selected GPS state. Items 35 and 36 are mutually exclusive.

Executing item 37 (GPS to Navigation Force command is set to 'FORCE') forces the navigation filter state to be automatically reset/updated with the selected GPS state (when available) on the next navigation cycle, the FORCE command taking precedence over the setting of the GPS to Navigation Auto/Inhibit command on that cycle. While the FORCE command is being executed, the setting of the GPS to Navigation Auto/Inhibit command remains as set by the crew. The 'FORCE' command is removed by navigation after the navigation reset is executed, so that the previous setting of the GPS to Navigation Auto/Inhibit command again controls the resetting of the navigation state with the selected GPS state on subsequent navigation cycles. Note that the 'FORCE' is a one-time force.

An "\*" next to the item number represents the selected setting. Note that only one setting will be indicated on a given navigation cycle. The indication is FORCE if the GPS to Navigation Force Command was selected. If the GPS to Navigation Force Command was not selected, the indication is either AUTO or INHIBIT, depending on the selection of the GPS to Navigation Auto/Inhibit Command.

The initial setting of the GPS to Navigation Auto/Inhibit command is 'INHIBIT'. It will also be set to 'INHIBIT' at OPS transitions. The initial setting of the GPS to Navigation Force command is 'OFF' and it will be set to 'OFF' at OPS transitions. The GPS to Navigation commands can also be set on SPEC 50 with the setting there also shown on the STATUS display.

These items will be allowed or not allowed in a given Operational Sequence depending on the value of the GPS\_LOCKOUT I-Load parameter. See tables in **(18)**.

- (20)** METERING OVERRIDE. Item entry 38 (METERING OVERRIDE) shall toggle the discrete controlling the override of navigation principal function metering of the updates to the user parameter reset state. The user parameter reset state is used by the user parameter navigation computation functions and is eventually used by guidance. Depending on the configuration of the navigation system as determined by item entries, either the selected GPS state or the baseline navigation state can be used to update the user parameter reset state. The updates to the user parameter reset state, defined as the difference between the user parameter reset state from the previous navigation cycle propagated to current time and either the baseline navigation state or the selected GPS state as determined by the crew, are metered to be within values defined by permission altitude dependent I-Loads to limit guidance transients. Metering of the updates to the user parameter reset state occurs under the following conditions: continuous metering limit checking when the selected GPS state is being used to update the user parameter reset state; metering until the update to the user parameter state lies within the I-Load tolerance, when switching from using the selected GPS state to using the baseline navigation state to update the user parameter reset state; metering until the update to the user parameter state lies within the I-Load tolerances, when using the baseline navigation state to update the user parameter reset state and the baseline navigation state has been reset to the selected GPS state. Item 38 is initialized OFF, with no asterisk being displayed (blank), so that metering is being performed under the conditions defined above. When toggled to ON, with an asterisk being displayed, metering is overridden and the updates to the user parameter state are not limited. In this case, the user parameter reset state is either the selected GPS state or the baseline navigation state as determined by prior item entries.

## GPS STATUS (Cont):

Execution of item 38 in any OPS or major mode other than GN&C OPS 3, and MM 602 and 603 will result in an 'ILLEGAL ENTRY' message being generated.

- (21)** SATELLITES TRACKED. This section shall display the GPS satellites being tracked by each receiver. Up to a maximum of six receiver channels can be displayed. If the receiver has less than six channels, the data will be blanked for the nonexistent channels. The order of the satellite number displayed reflects a one-to-one correspondence to the receiver channel tracking that satellite. Values from GPS SOP include 'blank' (no satellites being tracked) and 1 to 63. This data will be blank when the receiver is not in the NAV mode or experiencing a communication fault. The corresponding fields for uninstalled receivers will remain blank.
- (22)** DESELECT SATELLITES. Item entries 43 to 50 allow the crew to deselect satellites, valid satellite ID's being 1 to 63, as candidates for selection by the GPS receivers by building, based on Item Entries, a derived health status word. The '+' delineator deselects satellites and the '-' delineator removes satellites from being deselected as described below. As an example, 'ITEM 43 + 23 EXEC' will indicate to all GPS receivers that satellite ID 23 should not be used as a candidate for selection. If another satellite was previously deselected by item entry 43, an 'ILLEGAL ENTRY' message will be generated, the displayed data is unchanged and no change to deselected satellites occurs. If this satellite, ID 23 in this example, is currently deselected by another Item Entry, one of item entries 44 to 50 in this example, an 'ILLEGAL ENTRY' message will be generated, the displayed data is unchanged and no change to deselect satellites occurs.

'ITEM 43 - 23 EXEC' will indicate to all GPS receivers that satellite 23 should once again be considered as a candidate for selection. If item Entry 43 previously deselected satellite 23, then 'ITEM 43 - 23 EXEC' will result in a blank being displayed, and satellite 23 being available for selection. If satellite 23 is not currently deselected by item Entry 43, then an 'ILLEGAL ENTRY' message will be generated, the displayed data is unchanged and there is no change to deselected satellites.

Entry of satellite number of 0, less than - 63, or greater than + 63 will cause an 'ILLEGAL ENTRY' message to be issued. All satellites are initialized as available for selection. Satellite Deselection information for item entries 43 to 50 shall be maintained in the GNC major function base.

- (23)** GPS TIME ADJUST ENABLE. Item 39 enables a GPS time adjustment which is to be executed in the event of MTU failure. This item entry will bias the GPS time to force the GPS age-of-aiding from the GPCs to be equal to GPC\_GPS\_TARGET (typically 240 ms in PASS). This time adjustment will be made at every announced reset of the GPS aiding state, which occurs every 60 seconds. It should be noted that this item entry must be executed before GPC clock drift forces the GPS into the unaided (PVA) mode. PVA mode will occur when the aiding state sent to the GPC is outside 5 ms in the future to 2000 ms in the past. If the GPS modes to PVA, this item entry will have no effect and a ground uplink will be required to correct the onboard GPC time.

This item entry is illegal in OPS 1, OPS 9, and MM 601.



OPS G3 (ENTRY)

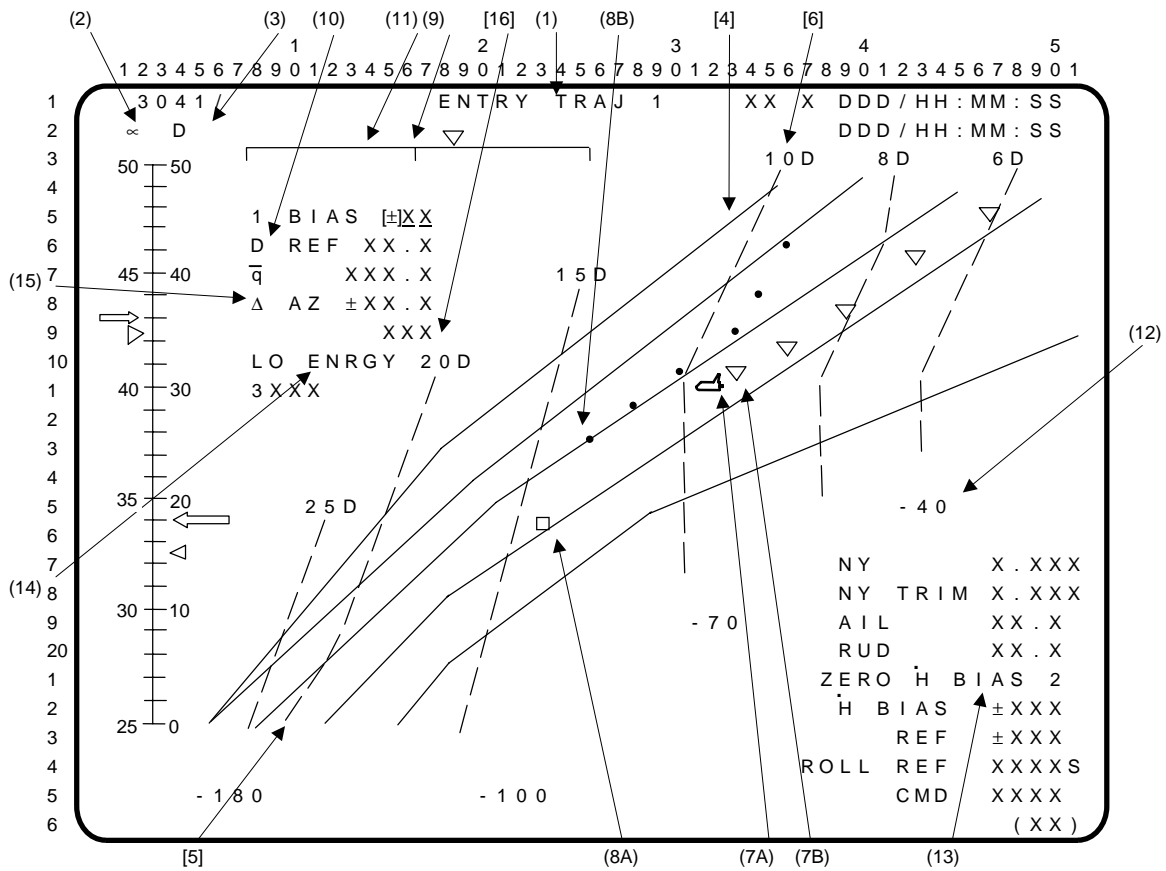

Note: [ ] denotes trajectory dependent data.

- (1) ENTRY TRAJ 1. A Guidance, Navigation, and Control (GNC) Operational Sequence (OPS) display of entry conditions with relative velocity from 24 kfps to 18 kfps. Called via OPS transition from MM303 to 304 (crew keyboard entry 'OPS 304 PRO'). Includes (2) Angle of Attack ( $\infty$ ) tape scale and symbols; (3) drag (D) tape scale and symbols; (4) trajectory guidelines; (5) nominal altitude rates; (6) constant nominal drag acceleration lines; (7) the orbiter's current location and previous locations; (8) the orbiter reference location and previous locations computed by guidance; (9) phugoid scale; (10), (12), (14), and (15) parametric data; (11) and (13) control items; and (16) PTI status indicator.
- (2)  $\infty$ . Dynamic symbols representing commanded  $\infty$  ( $\rightarrow$ ) and actual  $\infty$  ( $\triangleright$ ) move along the  $\infty$  tape scale (scale range is I-loaded). The symbols flash when they reach the off-scale position, and the  $\triangleright$  flashes if actual and commanded  $\infty$  differ by more than two degrees.
- (3) D. Dynamic symbols representing commanded D ( $\leftarrow$ ), and actual D ( $\triangleleft$ ) move along the D tape scale (scale range 0 to 50  $\text{fps}^2$ ).
- [4] Nominal trajectory guidelines (solid lines).
- [5] Nominal altitude rates correspond to the altitude rates required to guide the shuttle trajectory between the guidelines when the actual drag acceleration is matched to the nominal drag value.
- [6] Nominal constant drag acceleration lines (dashed lines) are labeled at the top with the drag value the line represents.
- (7) (7A) The dynamic orbiter symbol ( $\triangleleft$ ) is located on the plot using relative velocity (~24 to 18 kfps) and RANGE (~4000 to 1000 nm).  
(7B) Trailers ( $\nabla$ ) are left by the orbiter every 28.8 seconds on the plot to show the trend of the actual trajectory.

ENTRY TRAJ 1 (Cont):

- (8) **(8A)** The dynamic guidance symbol ( $\square$ ) is located on the plot using relative velocity and range computed by entry guidance. When the guidance has converged to a good solution, the  will be inside the  $\square$ .
- (8B)** Trailers ( $\bullet$ ) are left on the plot by the  $\square$  every 28.8 seconds to aid in monitoring of the convergence of the primary guidance (15.36 sec for ENTRY TRAJ 3, 4, 5).
- (9) Phugoid scale. Displays roll error based on achieving a biased reference drag.
- (10) D REF and  $\bar{q}$ . Data are displayed for the biased reference drag (D REF) in  $\text{fps}^2$  and dynamic pressure ( $\bar{q}$ ) in psf.
- (11) Item 1 provides a data entry to bias the reference drag (D REF).
- (12) NY, NY TRIM, AIL, RUD,  $\dot{H}$  BIAS,  $\dot{H}$  REF, ROLL REF, and ROLL CMD. Data are displayed for lateral acceleration (NY) in g's, lateral acceleration trim (NY TRIM) in g's, aileron trim (AIL) in deg, rudder trim (RUD) in deg, guidance-computed altitude reference term ( $\dot{H}$  BIAS) in fps, reference body roll angle (ROLL REF) in deg, and commanded body roll angle (ROLL CMD) in deg. ('AIL' and 'RUD' values will not be displayed when BFS is in the preengaged state.)
- (13) Execution of item 2 zeroes the  $\dot{H}$  BIAS computed by guidance.
- (14) Item 3 enables contingency abort TAL low-energy entry guidance. This item is initially inhibited and may only be enabled by crew item entry. Once enabled, subsequent entries of item 3 will alternately inhibit and enable this function. Status is shown by the character string 'INH' or 'ENA' next to item 3.
- The character string 'LO ENERGY' is initialized to normal brightness. Once low-energy guidance is enabled by item 3 and activated by entry software, the string is displayed double-overbright. If the entry software subsequently deactivates low-energy guidance (i.e., if the energy situation improves enough), 'LO ENERGY' will return to normal brightness and item 3 will return to its inhibited state.
- (15)  $\Delta$ AZ is a digital readout of the heading error in degrees with respect to the HAC tangent point and is displayed only in the PASS.
- [16] 'PTI' is displayed beneath ' $\Delta$ AZ' during a PTI maneuver. If the maneuver is inhibited (by automatic criteria or manual control), it will flash until the maneuver starts. It is blanked when the window is exited, the maneuver is complete, or an AOA or TAL abort is in progress. 'PTI' data are only available in the PASS.

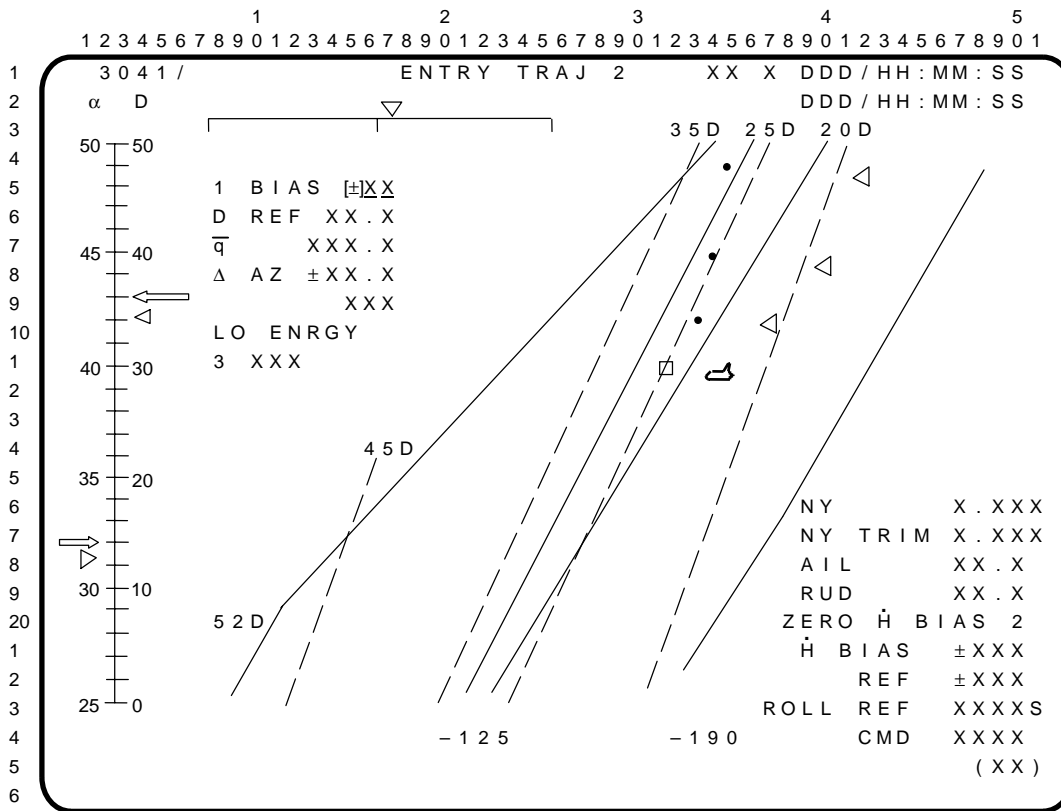

ENTRY TRAJ 2. A GNC OPS display of entry conditions with relative velocity from 19 to 14 kfps (approximately) and range-to-go from 1500 to 500 nm (approximately). See ENTRY TRAJ 1 for a description of the data on the display.

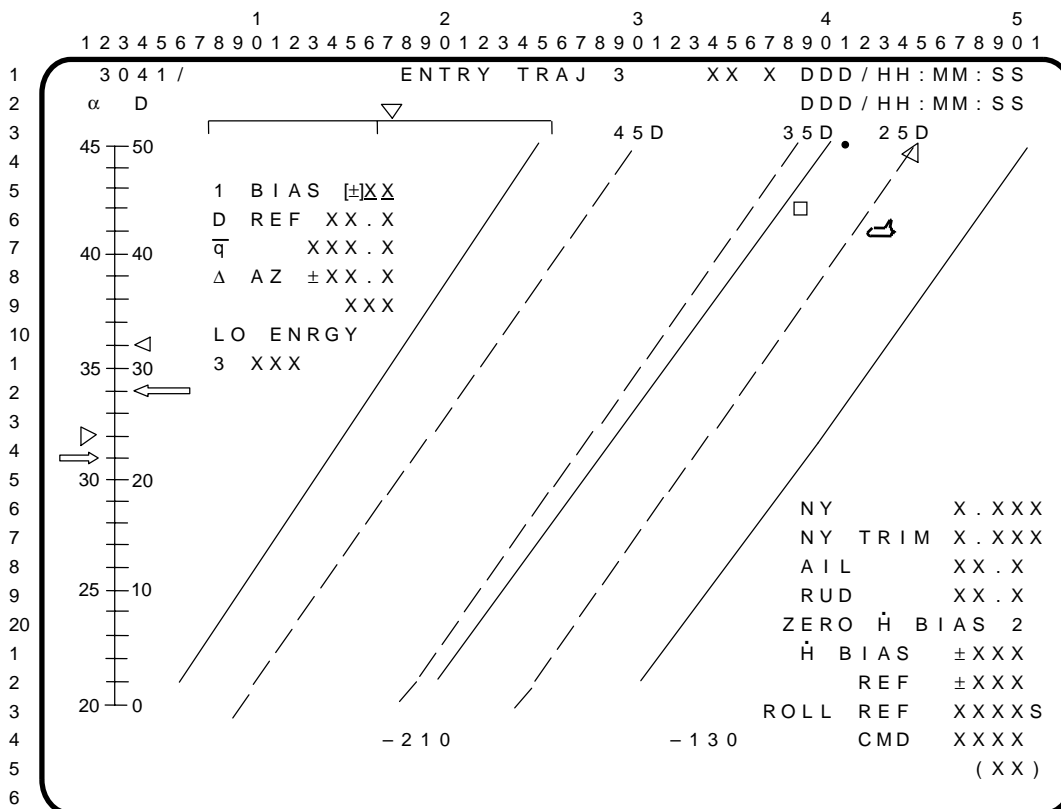

ENTRY TRAJ 3. A GNC OPS display of entry conditions with relative velocity from 14 to 10 kfps (approximately) and range-to-go from 700 to 350 nm (approximately). See ENTRY TRAJ 1 for a description of the data on the display.

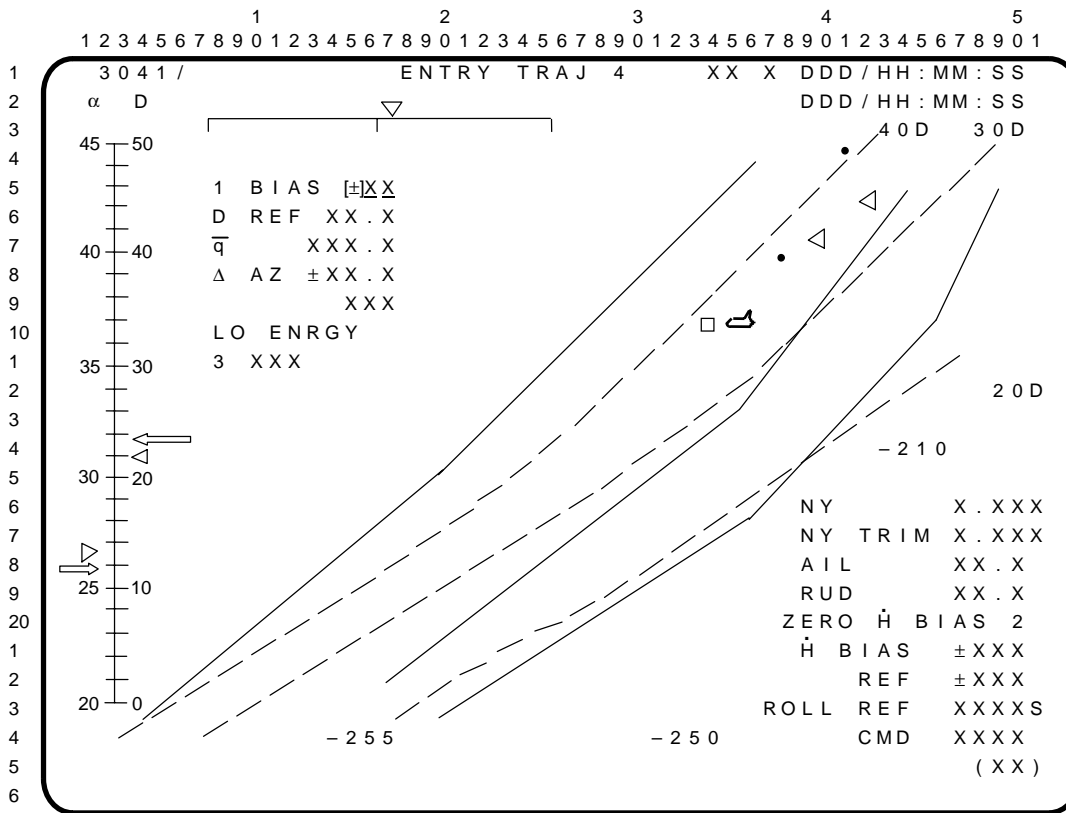

ENTRY TRAJ 4. A GNC OPS display of entry conditions during the high-energy portion of the transition phase. It is forced up automatically when the ENTRY TRAJ 3 passes out of range in OPS 3, or a PRO is performed from the ENTRY TRAJ 3 display in OPS 3. See ENTRY TRAJ 1 for a description of the data on display.

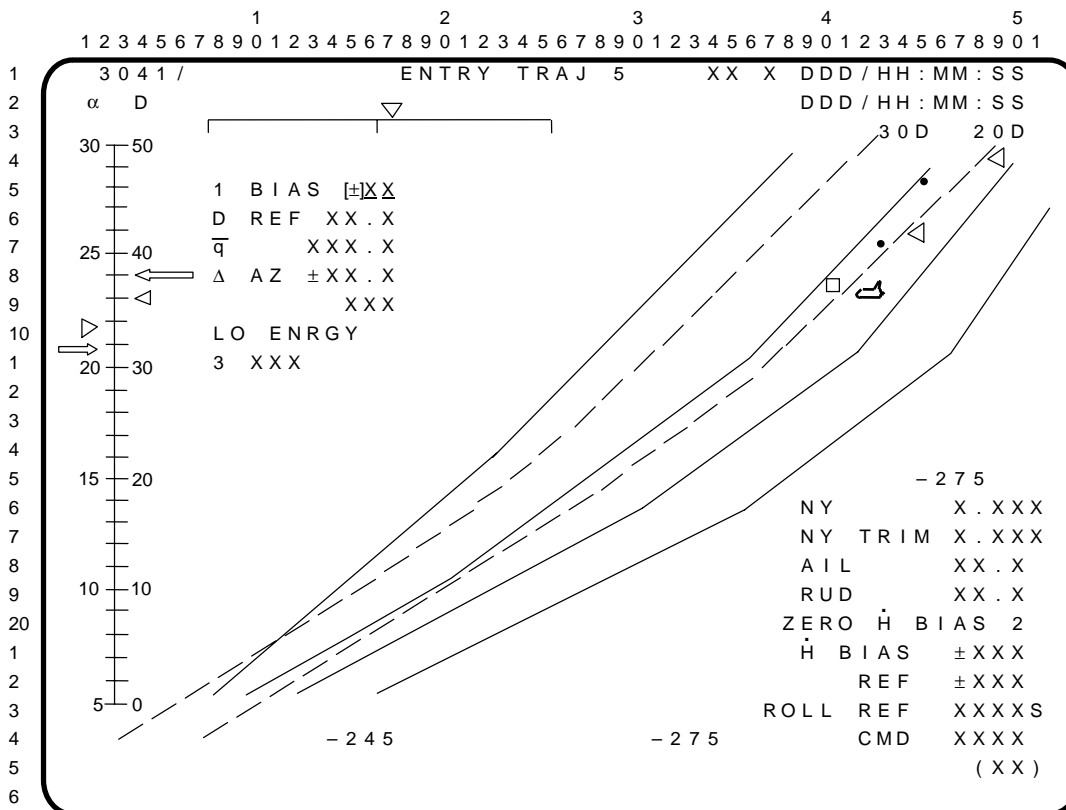

ENTRY TRAJ 5. A GNC OPS display of entry conditions during the low-energy portion of transition phase. See ENTRY TRAJ 1 for a description of the data on the display.

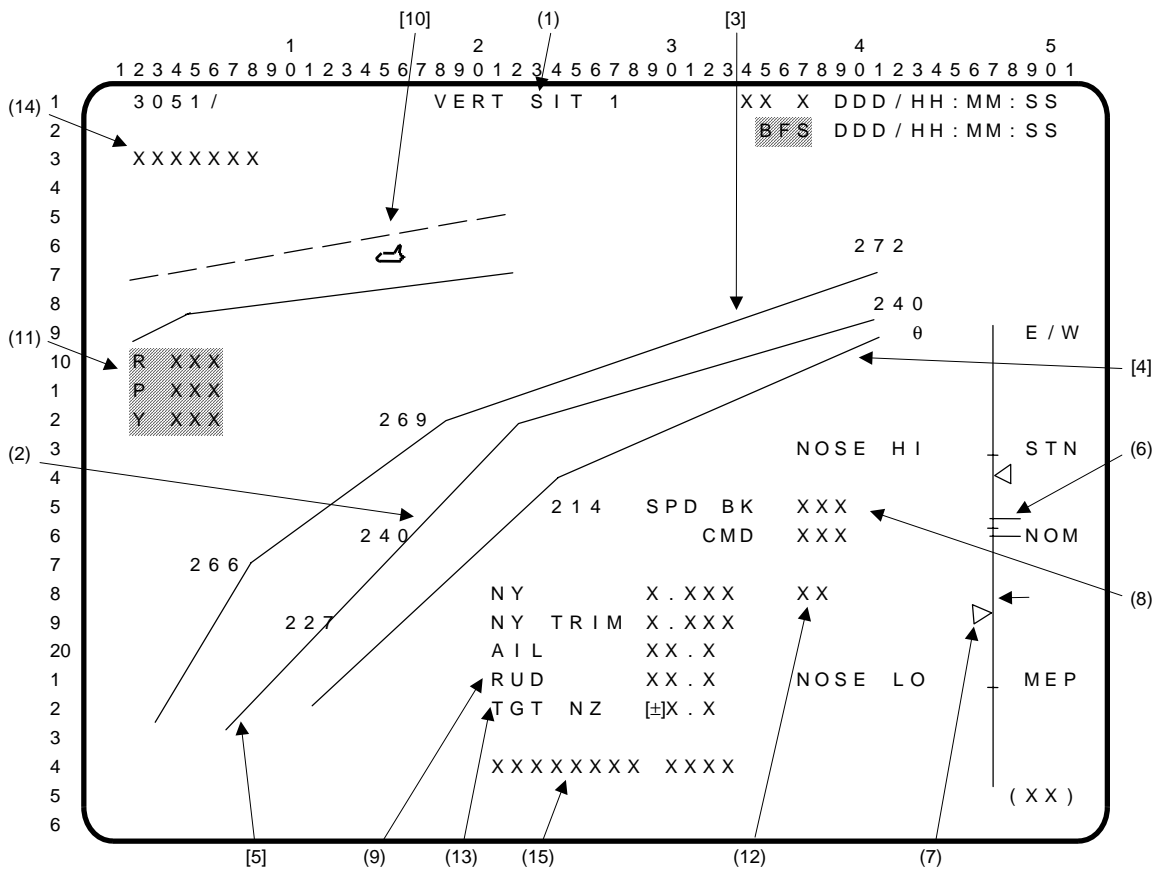

Note: [ ] denotes trajectory dependent data.  
 indicates parameters are driven and displayed on the BFS display only.

- (1) VERT SIT 1. A GNC OPS display forced up automatically, or when the crew performs an OPS 305 PRO or OPS 602 PRO in OPS sequences 3 and 6, respectively. Includes (2) display of vehicle state and altitude dissipation rate; [3]  $\bar{q}$  limit line; [4] max Lift-to-Drag (L/D) limit line; [5] nominal profile line; (6) and (7) energy-tape scale; (8) and (9) digital data; and [10] alpha/mach transition and lower limit lines.
- (2) The orbiter ( ) altitude is plotted versus range-to-go to waypoint 2 (WP2) via waypoint 1 (WP1). Altitude is scaled from 100,000 to 30,000 ft (approximately). Range is scaled from 70 to 10 nm (approximately). The orbiter symbol is rotated to indicate the current altitude dissipation rate.
- [3] The leftmost limit line ( $\bar{q}$  limit) represents the minimum range the vehicle can fly without exceeding the  $\bar{q}$  limit using full SPD BK. This line assumes that no winds are present.
- [4] The rightmost limit line (max L/D limit) shows the max range profile, SPD BK closed. The corresponding Equivalent Airspeed (KEAS) in knots is labeled under the line. This line assumes that no winds are present.
- [5] The nominal altitude profile is labeled with associated KEAS at various ranges. This line assumes that no winds are present.
- (6) The current shuttle energy state is displayed as '◁' on the right side of the vertical tape scale. If the shuttle energy state is above the S-Turn (STN) energy level, or below the Minimum Entry Point (MEP) requested energy level, and the minimum range criterion is met, the symbol flashes to show that the guidance should be S-turning (or requesting MEP retargeting). The nominal energy state and the energy limits are displayed as tick marks. The minimum desirable E/W level for an overhead approach is indicated by the OTT downmode energy state symbol (←). If E/W is below this level, a class 3 message ('OTT ST IN') is generated and 'OVHD' flashes on SPEC 50, calling for a downmode to a straight-in (STRT) approach (via item 6 on SPEC 50). The '←' blanks when the range to the runway is less than the minimum range at which the downmode calculation is performed.

VERT SIT 1 (Cont):

NOTE: For GRTLS, guidance does not begin to compute the current vehicle energy state, the nominal energy state (tick mark), or the energy limit until alpha transition begins (about 2 minutes into MM602). Prior to this time, these indicators will appear off-scale low and the energy triangle will flash.

- (7) The current shuttle pitch attitude ( $\theta$ ) is displayed as  $\triangleright$  on the left side of the vertical tape scale when relative velocity is less than an I-loaded limit. This symbol will flash when off-scale.
- (8) Actual speed brake (SPD BK) and commanded speed brake (CMD) positions are displayed in percent. 'CMD' is blanked after TAEM for BFS.
- (9) The lateral acceleration (NY) in g's, lateral acceleration trim (NY TRIM) in g's, aileron (AIL) trim in deg, and rudder (RUD) trim in deg are also displayed. For these parameters, positive is indicated by R (right) and negative is indicated by L (left). ('AIL' and 'RUD' values are not displayed when BFS is in the preengaged state.)
- [10] Alpha/mach transition and lower limit lines (used in MM602 only). The orbiter symbol indicates the current alpha/mach state and flashes when alpha is outside I-loaded limits.
- (11) BFS-computed roll, pitch, and yaw errors are displayed prior to BFS engage for comparison with PASS-driven ADI error needles. Each error value is preceded by one of the following characters: 'U', 'D', 'L', or 'R'. These indicate the fly-to direction of that error. If the roll error is 100 degrees or greater, an overflow indicator of 'R >>' or 'L >>' is displayed for a right or left fly-to error, respectively.

When in an NZ command phase (MM602 NZ-hold, MM603, and MM305), the pitch error field displays G error to the nearest tenth of a g. The G error (NZ error) is also a fly-to error ('U' or 'D') and may be used as a cross-check for the PASS ADI pitch error needle.

These errors and signs are not displayed after BFS engage.

- (12)\* 'NZ' is displayed overbright during RTLS whenever guidance is in the constant NZ phase.
- (13) A pullout normal acceleration (NZ) value is calculated in GRTLS TAEM Guidance in MM602 and displayed in (g's) in MMs 602 and 603. This field is not supported or displayed by BFS and is available in OPS 6 only.
- (14) In the PFS only, the character string 'BAILOUT' is displayed double overbright and flashing, one space in to indicate that the TAEM Guidance Abort Bailout mode has been armed, but not engaged. When both pitch and bank axes of the FCS have been moded to AUTO with the bailout mode armed, the character string 'BAILOUT' is displayed double overbright and not flashing, indicating that the bailout mode has been engaged. Otherwise, the character string is blanked.
- (15) The ECAL status character string 'ECAL/BDA', along with the item 1 and 'INH' or 'ENA' will be displayed in OPS 6, in the PFS only. The string shall be blanked in OPS 3 when ECAL logic is not possible. The ECAL item entry provides the crew the capability to enable/inhibit contingency abort OPS 6 ECAL guidance. It shall be displayed normal brightness intensity if the ECAL guidance is not active and shall be displayed double overbright if ECAL guidance is active. Execution of item 1 during an intact abort or while in OPS 3 shall result in an 'ILLEGAL ENTRY' message.

\*PROGRAM NOTES

- (12) Alpha-Recovery/NZ-Hold Transition. A subphase transition from alpha-recovery to NZ-hold in MM602 requires one of the following conditions:

either,

A. NZ >1.8G (I-load)

or

B. For intact abort only,  
ALPHA >45 degrees (I-load) in a guidance cycle, and  
ALPHA <45 degrees in a subsequent cycle.

Furthermore, the pitch error needle on the ADI displays:

1. The alpha error during the alpha-recovery subphase, and
2. The NZ error during the NZ-hold subphase.

Normally, Case A takes place and transition to NZ-hold subphase occurs automatically. Case B is normally forced by CSS takeover.

VERT SIT 1 (Cont):

The crew should monitor VERT SIT 1 during MM602 and wait for display of an overbright NZ which appears when guidance transitions to NZ-hold phase (either Case A or B). The pitch axis of the ADI error needle will display NZ error in NZ-hold subphase. The crew may then null the NZ error manually. (BO7339A/DR 46515)



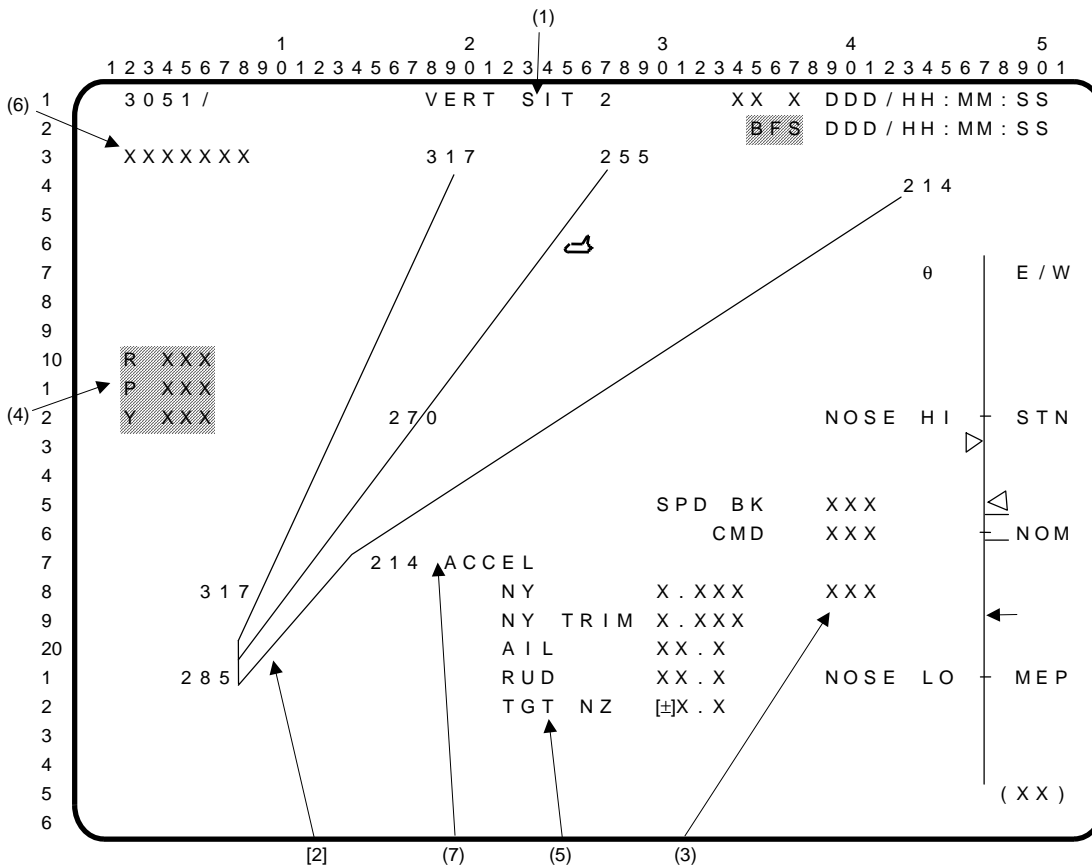

Note: [ ] denotes trajectory dependent data.

[ ] indicates parameters are driven and displayed on the BFS display only.

- (1) VERT SIT 2. A GNC OPS display forced up automatically in OPS sequences 3 and 6. The information shown on the display is described under VERT SIT 1. Altitude is scaled from 30,000 to 8,000 ft (approximately). Range-to-go to WP2 via WP1 is scaled from 25 to 5 nm (approximately).
  - [2] Left end points are connected to show all three profiles end up in the same EAS condition.
  - (3) The text 'A/L' is displayed and flashed when the TAEM guidance termination flag is set.
  - (4) BFS-computed roll, pitch, and yaw errors are displayed prior to BFS engage for comparison with PASS-driven ADI error needles. Each error value is preceded by one of the following characters: 'U', 'D', 'L', or 'R'. These indicate the fly-to direction of that error. If the roll error is 100 degrees or greater, an overflow indicator of 'R >>' or 'L >>' is displayed for a right or left fly-to error, respectively.
- When in an NZ command phase (MM602 NZ-hold, MM603, and MM305), the pitch error field displays G error to the nearest tenth of a g. The G error (NZ error) is also a fly-to error ('U' or 'D') and may be used as a cross-check for the PASS ADI pitch error needle.
- These errors and signs are not displayed after BFS engage.
- (5) A pullout normal acceleration (NZ) value is calculated in GRTLS TAEM guidance in MM602 and displayed (in g's) in MM602 and MM603. This field is not supported or displayed by BFS and is available in OPS 6 only.
  - (6) In the PFS only, the character string 'BAILOUT' is displayed double overbright and flashing to indicate the TAEM Guidance Abort Bailout mode has been armed, but not engaged. When both pitch and bank axes of the FCS have been moded to AUTO with the bailout mode armed, the character string 'BAILOUT' is displayed double overbright and not flashing, indicating that the bailout mode has been engaged. Otherwise, the character string is blanked.
  - (7) The static heading 'ACCEL' is not displayed by BFS.

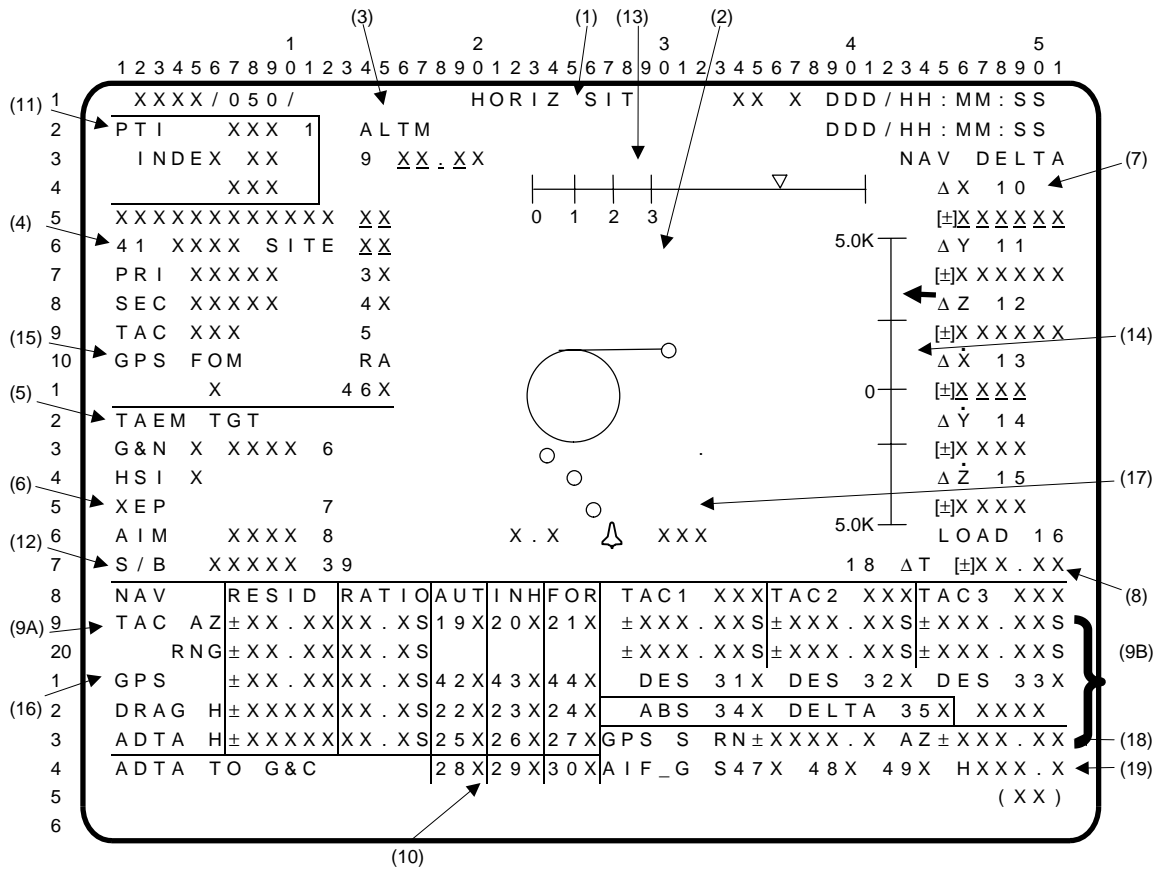

HORIZ SIT display before start of Heading Alignment Phase

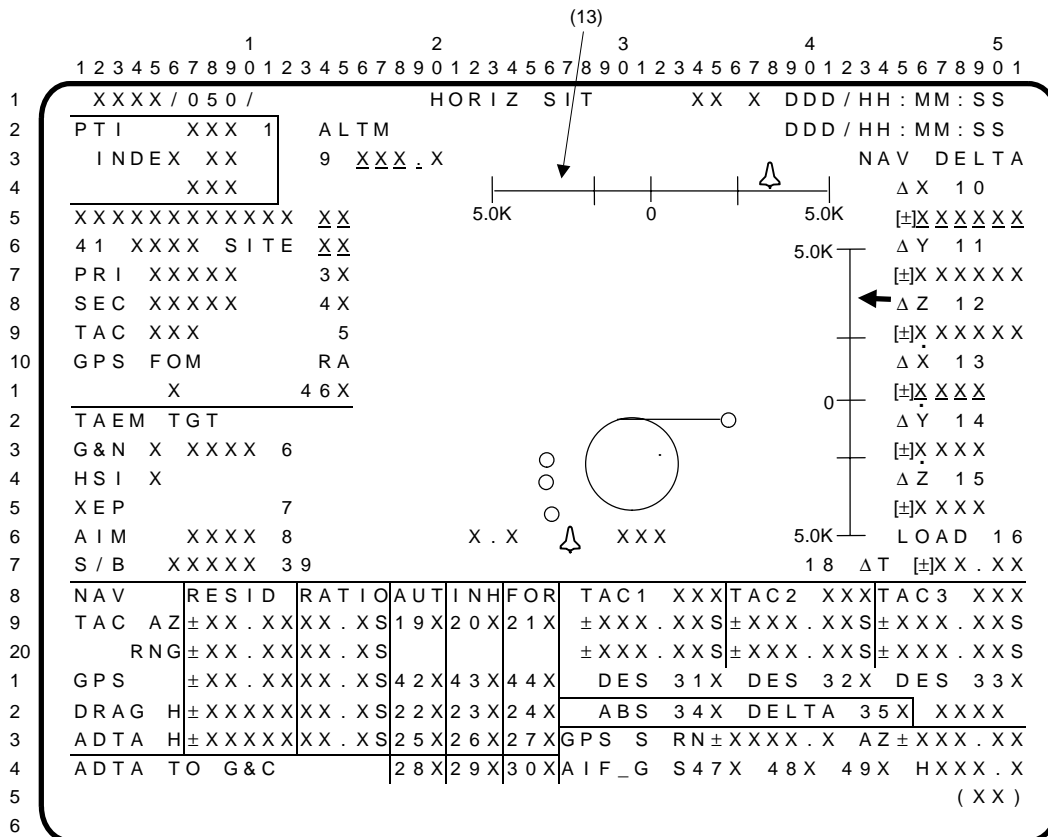

HORIZ SIT display after start of Heading Alignment Phase

- (1) HORIZ SIT display. A GNC SPEC available in OPS sequences 1, 3, and 6. Includes (2) display of orbiter position and heading relative to heading-alignment circles; (3) altimeter setting control; (4) TAL site, RTLS site, contingency abort site, runway, and TACAN designation controls; (5) approach indicators and control; (6) entry point indicator and control; (7) and (8) NAV update controls; (9) navigation filter displays and controls; (10) air data to Guidance and Control (G&C); (11) Programmed Test Input Control and indicators; (12) Speedbrake control; (13) display of time to HAC initiation or crosstrack error; (14) display of altitude error; (15), (16), (18) GPS filter displays & controls; (19) GPS slant range & azimuth to TACAN station; and (17) MSBLS data utilization indicator.
- (2) The graphic portion of the display contains a fixed orbiter symbol, three dynamic-position predictors, Heading-Alignment Circle (HAC), runway touchdown point (circle), and a linear extension from the touchdown point to the circle-intersection point. The predictor symbols represent the orbiter position predicted 20, 40, and 60 seconds in the future. The HACs and runway symbol move relative to the orbiter symbol while the orbiter symbol is fixed on the display. The data next to the orbiter symbol are the current value of normal acceleration in g's (total load factor in MM304, NZ in MM305, MM602, and MM603). The data and the orbiter symbol flash when normal acceleration exceeds an I-loaded limit.
- (3) Item 9 is used to input the barometric altimeter (ALTM) setting corrected to Mean Sea Level (MSL).

NOTE: The five underscores for this display field are offset one space to the left. Data entry and processing are not affected.

- (4) Item 40 (text is 40 TAL SITE X X; appears above item 41) allows selection of the TAL landing site in OPS 1. The display is initialized with the primary (I-loaded) TAL site selected and thereafter reflects crew inputs (possible index of 1 to 25). If a TAL abort is declared, item 40 will blank; the TAL site index will appear next to item 41; and the associated primary and secondary runways and TACAN data will appear next to items 3, 4, and 5. Item 40 is available in OPS 1 only. Execution in any other OPS or following an RTLS, TAL, or contingency abort selection will result in an 'ILLEGAL ENTRY' message. Entry of a TAL site that has not been designated as a TAL site will result in the message 'TARGET ERR TAL' being generated.

Item 41 allows the selection of the landing site in OPS 1, 3, or 6 from a possible index of 1 to 25 landing areas. Each site consists of one primary (PRI) and one secondary (SEC) runway, two TACANs, and an MSBLS (where available).

In addition, MECO targets are associated with each of the designated RTLS and TAL abort sites. The landing site index is displayed next to item 41 with the associated runway and TACAN channel data displayed next to items 3, 4, and 5. The display is initialized in MM101 with the primary (I-loaded) RTLS site selected. In OPS 1/6, 'RTLS', 'TAL', or 'CONT' is displayed next to item 41 to indicate the availability of RTLS, TAL, and contingency abort site selection. 'RTLS' is displayed throughout OPS 1 and 6 unless a TAL or contingency abort is selected. If a TAL abort is declared in OPS 1, 'TAL' is displayed until either a transition to OPS 3 or a contingency abort is selected. If a contingency abort is declared, 'CONT' is displayed throughout the remainder of OPS 1 and OPS 6. An alternate RTLS site can be chosen (which also specifies the RTLS MECO targets) up until powered pitchdown in MM601. After powered pitchdown, the RTLS landing site can be changed, but the MECO targets will not be updated. Entry of an erroneous RTLS site will result in the message 'TARGET ERR RTLS' being generated. If an erroneous RTLS site is selected prior to RTLS abort selection, the item entry will be rejected. If it is selected after RTLS abort selection, the error message is still generated; however, the nav data are accepted and guidance will steer to that site (although the new MECO target line data will be rejected).

When a TAL abort is declared, the data associated with items 41, 3, 4, and 5 will automatically change to reflect the TAL site selected via item 40. Entry of a TAL site changes both the TAL MECO targets and landing site; an alternate TAL site can be chosen up until fine countdown (MECO -10 seconds). After fine countdown, the TAL landing site can be changed; however, the MECO targets will not change. Entry of an erroneous TAL will result in the message 'TARGET ERR TAL' being generated; the erroneous target will be accepted by the display and NAV, but not by Guidance.

## HORIZ SIT (Cont):

When a contingency abort is declared, items 41, 3, 4, and 5 will remain the same. However, any of the 25 possible landing areas can be selected, and no 'TARGET ERR' messages will be generated. The MECO targets associated with the site selected via item 41, if any, will be ignored by Powered Contingency Guidance.

In OPS 3, 'LAND' is displayed next to item 41. Any of the 25 possible landing areas can be selected, and no 'TARGET ERR' messages will be generated.

Items 3 and 4 allow selection of either the primary or secondary runway of a selected landing site. The IDs of the primary and secondary runways are displayed next to items 3 and 4, respectively. Primary is automatically selected (indicated by an '\*') once a landing site is specified. Items 3 and 4 are mutually exclusive.

Item 5 provides the capability to select either of two TACANs associated with a selected landing site. When a landing site is selected, the primary TACAN is automatically selected, and subsequent executions of item 5 alternately select the secondary and primary TACANs. The channel ID of the selected TACAN is displayed next to item 5.

- (5)\* Item 6 designates the HAC to be used for targeting during entry or RTLS. 'OVHD' or 'STRT' is displayed next to item 6 to indicate an overhead or straight-in approach. The display is initialized in OPS 1, 3, and 6 with OVHD selected and it remains selected unless downmoded by crew selection of the alternate HAC. When a new landing site (item 41) is selected, the approach will be reinitialized to OVHD and if the energy level is too low, but the range to the runway and the required turn angle are within I-loaded limits, OVHD will flash and a class 3 message will be generated. The flashing terminates when STRT is selected. Indicators 'L' and 'R' are also displayed at G&N and HSI to identify whether the left or right HAC is the target point. These indicators are initialized upon transitioning into MM304 and MM601 after MECO (G&N), or 602 (HSI) and will be blank prior to that time. Item 6 is legal only in MM101, MM304, MM305, MM602, and MM603.
- (6) Item 7 (XEP) allows the crew to alternately select the nominal entry point or the minimum entry point for guidance targeting. Selection is indicated by NEP or MEP, respectively. The indicator is initially driven to NEP. Item 8 (AIM) allows the crew to alternately redesignate the glide slope ground intercept point between nominal and closest to the runway (for high head winds) until TAEM/Autoland Interface. Selection is indicated next to item 8 by NOM and CLSE. The display is initialized with NOM selected.
- (7) NAV DELTA. Items 10 thru 15 are used to enter position ( $\Delta X$ ,  $\Delta Y$ ,  $\Delta Z$ ) and velocity ( $\Delta XDOT$ ,  $\Delta YDOT$ , and  $\Delta ZDOT$ ) deltas in runway coordinates. Item 16 is used to update the NAV state with the deltas entered by items 10 thru 15. Item 17, corresponding to the state vector transfer item in the BFS, is illegal in the PASS. Execution of item 17 in the PASS or item 16 during an uplink state update will result in an 'ILLEGAL ENTRY' message.
- (8) Item 18 provides the capability to update state vector downtrack errors by means of adding or subtracting a delta time in seconds. The update is performed after a time is entered via item 18 and is followed by the execution of item 16 (LOAD). The delta time display field is zeroed when the display is first called and will be rezeroed upon completion of a delta time update by Entry Navigation. Item 18 is legal in OPS 3 only; executing this item in any other OPS will cause an 'ILLEGAL ENTRY' message to be generated.
- (9) (9A)\* Navigation filter displays and controls for Tactical Air Command and Navigation System (TACAN) azimuth (TAC AZ) and range (RNG), drag altitude (DRAG H), and Air Data Transducer Assembly altitude (ADTA H) are provided. (For GPS, see (16)). For each parameter, the output from its selection filter minus the composite NAV state vector estimate of that data forms the residual (RESID). For each parameter, the ratio (RATIO) of actual residual to the maximum allowable residual is displayed in the RATIO column. Items 19, 22, and 25 are used to allow navigation to select data to be used if it passes the edit test. If the RATIO is less than one, the data pass the update edit test and are incorporated into the state vector. A status column to the right of the RATIO contains a '↓' when the parameter has failed the update edit test a specified percentage of times (I-loaded). The '↓' disappears when a certain percentage of the data passes the edit test. Items 20, 23, and 26 inhibit (INH) the incorporation of measured data into the state vector. Items 21, 24, and 27 force (FOR) the navigation filter to use the data if the data are being processed. An '\*' appears next to any item (19 thru 27) that has been selected. The display is initialized with items 20, 22, and 26 selected. Items 19 thru 21, 22 thru 24, and 25 thru 27 are mutually exclusive. The residual and ratio data fields are blanked for a parameter if its data are not being processed.

## HORIZ SIT (Cont):

- (9B)\*** The TACAN channel of the ground station that TAC 1, 2, and 3 are locked onto or attempting to lock onto is displayed. TACAN azimuth and range are displayed for the TACANs in either absolute or delta values as selected by item 34 or 35. Items 34 and 35 are mutually exclusive, and an "\*" will be driven next to the item selected. The display is initialized with item 35 selected. A status column is provided for the azimuth and range for each TACAN. A blank in the column indicates normal operation. A '↓' is displayed if the parameter is declared failed by RM. An 'M' is displayed if data are missing. A '?' is displayed if a dilemma is declared by RM. Items 31 thru 33 allow a failed TACAN to be deselected/reselected. The word 'TEST' is displayed if the self-test is being conducted. If a TACAN should lock-on while the other two units are in self-test, for the remainder of the test all three TACANs will show '?'. This is a display confusion factor only; TACAN RM is aware of which two are actually in dilemma and will not use the third unit until the self-test is complete.
- (10)** Items 28 thru 30 provide control over the source of air data parameters input to GNC. Item 28 (AUT) provides auto transition from NAV-derived air data to default NAV to ADTA. Item 29 (INH) inhibits the ADTA data and enables either default NAV or NAV-derived data. Item 30 (FOR) forces the use of ADTA data. In 'AUT', MACH must be less than 2.5 to process ADTA parameters, while in 'FOR' no such MACH number constraint exists. These three items are mutually exclusive and an "\*" is driven next to the selected item. The display is initialized with item 29 selected.
- (11)** Item 1 (PTI) allows the crew to alternately enable (ENA) or inhibit (INH) programmed test input maneuvers in MM101, MM102, MM304, and MM305. However, there will be no PTIs performed during ascent. The display is initialized with PTIs inhibited. PTIs are also inhibited/terminated manually by going to the CSS mode in the DAP or, in OPS 3, by taking the RHC out of detent. PTI maneuvers are enabled/reenabled by reestablishing the auto mode in the DAP and executing item 1. The maneuver to be performed is indicated next to INDEX by '0' for OPS 1 and by 1 to 25 in OPS 3. 'PTI' is displayed oversized and overbright below the INDEX data field during a maneuver. 'PTI' flashes if in the PTI initiation window and the maneuver is not active. It is blanked and the PTI window is incremented when the maneuver is terminated or, if no maneuver is performed, when the window is exited. It will be blanked in OPS 1 and throughout a TAL or AOA.
- (12)** Item 39 (S/B) provides the capability to select one of two modes of speedbrake control logic during OPS 3 and 6. Upon transition to MM601 or MM301, if a TAL abort has not been declared, the display will be initialized to the nominal mode, displaying the text 'NOM' to the left of the item number. In MM301, if a TAL abort has been declared, the display is initialized to the short field mode. Subsequent executions of item 39 alternate the choice between NOM and SHORT modes. The short field mode is indicated by displaying the text 'SHORT' double overbright. Execution of item 39 is legal down to the transition to the Approach and Landing (A/L) Guidance phase. An 'ILLEGAL ENTRY' message will result if item 39 is executed either after the A/L Guidance transition, or anytime during OPS 1.
- (13)** The time to Heading Alignment Cone (HAC) initiation is displayed in MM305 and MM603 on a horizontal scale during the TAEM Acquisition or S-turn phase. A downward pointing triangle becomes visible 20 seconds prior to HAC initiation. This symbol appears on the right (left) end of the scale for a left (right) turn onto the HAC and remains there flashing until 10 seconds to HAC initiation. The symbol then stops flashing and moves from right (left) to left (right) for a left (right) turn onto the HAC. When the symbol reaches the 0 second tickmark, the crew should expect the ADI roll error needle to deflect indicating the roll onto the HAC is being commanded. Time to HAC initiation is also displayed on the ADI roll rate pointer if the ADI RATE switch is in the MED position.

Once the Heading Alignment phase has begun, the horizontal scale changes from time to HAC initiation to a crosstrack scale. During the Heading Alignment phase, radial distance from the HAC is displayed with a full scale deflection of 5,000 ft. During the Prefinal and Approach and Land phases, the vehicle's distance from the extended runway centerline (Y position in runway coordinates) is displayed with a full scale deflection of 2,500 ft. A shuttle symbol is used in both cases for this display to indicate that it represents the vehicle's actual location with respect to the HAC or runway centerline rather than a "fly-to" indicator. The symbol will flash when at full scale deflection. Crosstrack error is also displayed on the ADI yaw rate pointer with the same full scale deflection but in a "fly-to" sense when the ADI RATE switch is in the MED position.

HORIZ SIT (Cont):

In addition to radial distance and Y position, the ADI yaw rate pointer displays heading error in a “fly-to” sense prior to the HAC if the ADI RATE switch is in the MED position.

The horizontal scale, tickmarks, labels, and symbol blank at an altitude of 7,000 ft to indicate that the ADI rate pointers no longer display position error information when the ADI RATE switch is in the MED position (the ADI rate pointers stow at 7,000 ft and revert back to rates after a 3 second delay).

- (14) The altitude error computed by guidance based on a spiral HAC is displayed in Major Modes 305 and 603 on a vertical scale with a full scale deflection of 5,000 ft prior to the Prefinal phase or a full scale deflection of 1,000 ft during the Prefinal and Approach and Landing phases. A left pointing arrow is used to indicate that altitude error is displayed in a “fly-to” sense. The symbol will flash when at full scale detection. Altitude error is also displayed on the ADI pitch rate pointer with the same full scale deflection when the ADI RATE switch is in the MED position.

The vertical scale, tickmarks, labels, and symbol blank at an altitude of 7,000 ft to indicate that the ADI rate pointers no longer display position error information when the ADI RATE switch is in the MED position (the ADI rate pointers stow at 7,000 ft and revert back to rates after a 3 second delay).

- (15) GPS FOM & RA. This field displays the Figure of Merit (FOM) or estimate of position error for each receiver. The FOM is related to the error as follows:

FOM	Estimated error (meters)
1	$e \leq 25$
2	$25 < e \leq 50$
3	$50 < e \leq 75$
4	$75 < e \leq 100$
5	$100 < e \leq 200$
6	$200 < e \leq 500$
7	$500 < e \leq 1000$
8	$1000 < e \leq 5000$
9	$5000 < e$

The FOM data from the GPS Receiver State Processing Principal Function will be static when the receiver is not in NAV mode (i.e., in TEST or INIT mode) or when the GPS NAV data used by the GPS Receiver State Processing Principal Function are not valid.

If the FOM exceeds a pre-mission determined I-Load tolerance, a ‘↓’ shall be driven in the appropriate parameter status indicator field next to the displayed FOM value and displayed double overbright. If the receiver state estimate fails the FOM quality assessment check, it is excluded as a candidate from the GPS state vector selection process, unless forced to be a candidate for selection by the crew, in which case the ‘↓’ remains. The corresponding fields for uninstalled receivers will remain blank.

RA refers to Radar Altimeter; item 46 allows RA data to be used by the GPS receiver. The item toggles between inhibiting and permitting the use of such data; a blank and an ‘\*’ are driven beside item 46, respectively. It is initialized in the inhibited state. It is legal in all OPS except when the I-loaded constant ALT\_RA\_CUTOFF\_HIGH  $\leq$  zero. In this case, executing item 46 will result in an ILLEGAL ENTRY message.

## HORIZ SIT (Cont):

- (16) This line displays GPS NAV data. RESID and RATIO are indications of GPS data quality. RESID is the difference in nautical miles between the GPS and navigational software position vectors. RATIO is the ratio of the the position or velocity residual to the maximum allowable position or velocity residual. A 'P' for position or a 'V' for velocity will be driven in the first space of the RATIO data field to indicate which sort of ratio is being displayed (the 'P' or 'V' will be double overbright if a propagated state is being used because no GPS state has passed the residual edit test on the current NAV cycle). Both fields will be blank in OPS 1 or OPS 6, or if no GPS receivers are installed.

If RATIO < 1 (indicating good GPS data), the status field next to it will be blank; if RATIO > 1 (indicating bad GPS data), a '↓' will be driven in that status field; if RATIO > 1 and the crew force GPS data to NAV anyway (by executing item 44 - see following table), an '↑' will be driven in the status field.

GPS TO NAV COMMAND. Items 42, 43, and 44 set the GPS to Navigation Auto/Inhibit command and the GPS to Navigation Force command. Executing item 42 ('AUTO') allows the navigation filter state(s) to be automatically reset/updated with the selected GPS state (when available) every I-Load specified time interval. Executing item 43 ('INHIBIT') inhibits the resetting of navigation filter state(s) with the selected GPS state. Items 42 and 43 are mutually exclusive.

Executing item 44 ('FORCE') forces the navigation filter state to be automatically reset/updated with the selected GPS state on the next navigation cycle, the FORCE command taking precedence over the setting of the GPS to Navigation Auto/Inhibit command on that cycle. While the FORCE command is being executed, the setting of the GPS to Navigation Auto/Inhibit command remains as set by the crew. The 'FORCE' command is removed by navigation after the navigation reset is executed, so that the previous setting of the GPS to Navigation Auto/Inhibit command again controls the resetting of the navigation state with the selected GPS state on subsequent navigation cycles. Note that the 'FORCE' is a one-time force.

An '\*' next to the item number represents the selected setting. Note that only one setting will be indicated on a given navigation cycle. The indication is FORCE if the GPS to Navigation Force Command was selected. If the GPS to Navigation Force Command was not selected, the indication is either AUTO or INHIBIT, depending on the selection of the GPS to Navigation Auto/Inhibit Command.

The initial setting of the GPS to Navigation Auto/Inhibit command is 'INHIBIT'. It will also be set to 'INHIBIT' at OPS transitions. The initial setting of the GPS to Navigation Force command is 'OFF' and it will be set to 'OFF' at OPS transitions. The GPS to Navigation commands can also be set on SPEC 50 with the setting there also shown on the STATUS display.

If any of these items are executed in OPS 1 or OPS 6, an 'ILLEGAL ENTRY' message will result. In OPS 3, execution of these items is controlled by the value of the GPS\_LOCKOUT I-load parameter. If GPS\_LOCKOUT is 0, 1, or 2, execution of these items will produce an 'ILLEGAL ENTRY' message in OPS 3 as well; if GPS\_LOCKOUT is 3 or more, execution of these items in OPS 3 will be permitted.

- (17) The character string 'MLS' will be displayed in double overbright if MSBLS data is being used by the navigation filter and the MSBLS derived navigation state is being sent to guidance; otherwise, the character string is blanked.
- (18) The slant range (RN) in nautical miles and azimuth (AZ) in degrees to the auto selected TACAN station (shown by the three-letter call sign in item 5 of the HORIZ SIT Display) and the altitude above the landing site in thousands of feet are displayed using the GPS state estimate from the installed receivers (LRU2 for the single string case). The slant range and azimuth are displayed in either absolute or delta mode in the display fields, similar to the TACAN range and azimuth data (refer to **(9B)**). A single parameter status indicator is provided for the range, azimuth, and altitude data to the right of the GPS label. A blank for the status indicator indicates nominal processing of state data from the receiver. If the receiver state is indicated as not good by the receiver (receiver data good is off) or the receiver state time is more than 2 seconds in the past than the user parameter state time, a '↓' will be displayed in the parameter status indicator field and the data will be blanked. This data will also be blank in OPS 1 and in MM301, MM302, MM303, and MM601.

## HORIZ SIT (Cont):

- (19)** Items 47, 48, and 49 set the GPS to Guidance and Control Auto/Inhibit/Force command. An '\*\*' next to the item number set by the application software represents the selected setting. The three item entries are mutually exclusive.

Selecting item 47 ('AUTO') commands the application software to automatically reset/update the user parameter (UPP) state vector with the selected GPS state every navigation cycle (when a selected state is available), rather than resetting the UPP state with the selected navigation filter state. Item 48 ('INHIBIT') inhibits the application software from using the selected GPS state to reset the UPP state. Item 49 sets the command to 'FORCE'. In this setting, the command performs two functions in the application software: (1) it forces the GPS receiver states from all installed receiver states, that are determined by the receiver to have good data (receiver data good is on) and are not deselected by the crew (item 26, 27, or 28 (DES RCVR) on SPEC 55), to be processed by the GPS state selection filter, forcing a selection of a GPS state; and (2) it forces the use of this selected state in resetting the UPP state for guidance.

Unlike the GPS to Navigation Force command, which is a one-time force, the GPS to guidance and control 'FORCE' condition remains active until either item 47 or 48 is selected.

If item 47 is executed and no selected GPS state vector is available, the application software will command a '↓' in the status field before the item 47 label. The '↓' will be removed once a selected state becomes available. If item 49 is executed and no selected GPS state is available and all installed receivers are either deselected or indicate that their state data are not good, the application software will also command a '↓' in the status field before the item 47 label. The '↓' will be removed once the state of a receiver which has not been deselected is indicated as good by the receiver, since the GPS to G&C FORCE setting will force a selected state to be made available on that navigation cycle.

In preland, if TACAN is not in FORCE, item 47 ('AUTO') has been selected, MLS data good, and a selected GPS state is available, the application software will command a '↓' in the parameter status indicator field before the item 47 label, indicating to the crew that the processing of MSBLS measurements by the application software and using the MSBLS derived navigation state for guidance has precedence over the "automatic" use of the selected GPS state in providing the state for guidance. If item 49 ('FORCE') has been selected, however, no '↓' will appear in the parameter status indicator field before the item 47 label and the following application software conditions apply:

- (1) the application software will use the selected GPS state (when available) for guidance;
- (2) MSBLS measurements will not be processed by the application software and if TACAN is in AUTO, TACAN measurements will be processed.

The GPS to Guidance and Control command will initially be set to 'INHIBIT'. It will also be set to 'INHIBIT' at OPS transitions. The GPS to G&C command can also be set on SPEC 55 with the setting there also shown on the HORIZ SIT display.

If any of these items are executed in OPS 1 or OPS 6, an 'ILLEGAL ENTRY' message will result. In OPS 3, execution of these items is controlled by the value of the GPS\_LOCKOUT I-load parameter. If GPS\_LOCKOUT is 0, 1, or 2, execution of these items will produce an 'ILLEGAL ENTRY' message in OPS 3 as well; if GPS\_LOCKOUT is 3 or more, execution of these items in OPS 3 will be permitted.

### \*PROGRAM NOTES

- (5)** OVHD to STRT Toggle in MM101. Item 6 cannot be used to toggle back to OVHD once STRT has been selected in MM101. The desired landing site can then be reselected (item 41), which will reset OVHD. (DR 42650)
- (9A)** Possible Display of Invalid Bearing Data. Due to the timing between RM, SOP, and display software modules, it is possible for TACAN bearing data flagged as 'invalid' by the TACAN SOP to be displayed if a TACAN is alternately achieving and breaking lock at about 1 Hz. An intermittent 'M' on the display will usually occur in this situation. (DR 37577)
- (9B)** Repetitive TACAN Self-Test. If a dilemma exists between two TACAN units and self-test is unable to resolve the dilemma, there is a possibility that the software could get into a loop which would continue to command self-test every eight seconds. Deselecting one of the units or moding the units to T/R will be required to clear up the problem. (DR 37693/45703)



	1										2										3										4										5									
(2)	1	2	3	4	5	6	7	8	9	0	1	2	3	4	5	6	7	8	9	0	1	2	3	4	5	6	7	8	9	0	1	2	3	4	5	6	7	8	9	0	1	2	3	4	5	6	7	8	9	0
1	XXXX / 053										CONTROLS										XX X										DDD / HH : MM : SS																			
2																															DDD / HH : MM : SS																			
3																																																		
4	SEC	ACT	CK								AERO	PORT	STAT								SSME	PORT	STAT																											
5																																																		
6	CH1	1	X								L	OB	1	S	S	S	S				L	P	S	S	S	S																								
7														I	B	2	S	S	S	S				Y	S	S	S	S																						
8											R	I	B	3	S	S	S	S				C	P	S	S	S	S																							
9														O	B	4	S	S	S	S				Y	S	S	S	S																						
10	START	5	X								R	UD	5	S	S	S	S				R	P	S	S	S	S																								
1	STOP	6	X								S	P	D	6	S	S	S	S				Y	S	S	S	S																								
2																																																		
3	NEG	STIM																		ACT / CH																														
4	ENA	7	X								8	BYPASS				X	X																																	
5											9	RESET				X	X																																	
(3)																																																		
7	LRU	AA	RG	SURF	FDBK																																													
8			DES	DES	DES																																													
9			DES	DES	DES																																													
20	1	10	X	S	14	X	S	18	X	S																																								
1	2	11	X	S	15	X	S	19	X	S																																								
2	3	12	X	S	16	X	S	20	X	S																																								
3	4	13	X	S	17	X	S	21	X	S																																								
4																																																		
5																																																		
6																															( X X )																			

- (1) CONTROLS is a specialist function (SPEC 53) available in GNC OPS 1, 3, and 6. This display provides the capability to control secondary actuator checks and deselection/reselection of AAs, RGAs, and aerosurface position feedback transducer strings. This display also allows the crew to monitor the status of the aerosurface and SSME actuator secondary ports.
- (2) SEC ACT CK. Items 1 thru 4 select actuator channels 1 thru 4 for testing and item 5 (START) initiates testing of the aerosurfaces on the selected channel. An '\*' is displayed next to items 1 thru 5 when selected. Execution of item 5 without a channel selected will result in an 'ILLEGAL ENTRY' message. Execution of item 6 terminates testing and blanks the '\*'s next to items 1 thru 5. If a second channel is selected during testing, the '\*'s next to the previously selected channel and next to item 5 will be blanked and an '\*' will appear next to item 6. Item 7 (NEG STIM ENA) changes the polarity of the secondary actuator check. An '\*' next to item 7 indicates negative polarity; a blank indicates positive polarity. Items 1 thru 7 are legal in MM301, MM302, and MM303 only. Items 1 thru 5 and 7 are initialized blank (no '\*'s); item 6 is initialized with an '\*' next to the item.

The aerosurface port status (AERO PORT STAT) for each channel is shown as blank (no bypass), '↓' (bypassed), or 'M' (missing data). Aerosurfaces which do not show '↓' during testing can be checked by placing the appropriate FCS channel switch (on panel C3) in the OFF position. All ports in the off channel should then show '↓' on the display. These '↓'s will remain even if a new SEC ACT CK channel selection is made, until the switch is moved from OFF. Items 8 (BYPASS) and 9 (RESET) are used to bypass and reset, respectively, the aerosurface secondary actuator port specified by the ID entered below ACT/CH. Legal IDs are those shown in the table in paragraph 8, FCS/DED DIS C/O display (OPS 8011). These IDs are initialized at zero and entry of an ID for either item causes the other to be zeroed. When item 8 is used, the selected ACT/CH(s) will remain bypassed even if the FCS channel switch on PNL C3 for that channel is in 'OVERRIDE'. Item 9 will reset any selected port(s) that may have been bypassed with item 8 and will also momentarily reset a selected port that may have been bypassed due to a failure.

## CONTROLS (Cont):

- (3)** LRU AA/RGA/SURF FDBK. Items 10 thru 13, 14 thru 17, and 18 thru 21 provide for deselection/reselection of accelerometer assembly (AA), rate gyro assembly (RGA), and aerosurface feedback (SURF FDBK) transducer strings as candidates for the selection filter. An '\*' next to an item number (10 thru 21) indicates that the corresponding LRU/string has been deselected by the crew or, for AAs and RGAs (items 10 thru 17), deselection can be triggered by RM fail detection. The deselect status of items 10 thru 21 is carried over when transitioning from OPS 1 to OPS 3/6. In MM101 through MM106/MM601, items 18 thru 21 select/deselect body flap transducers only. Execution of any item, 10 thru 21, with an '\*' present, reselects the corresponding LRU and blanks the '\*'. The status column for each item (10 thru 21) displays an 'M' when a comm fault is declared, is blank (normal condition) or, for items 18 thru 21 only, displays a '↓' when RM declares one or more transducers in the string to be failed.
- (4)** SSME PORT STAT. The port status for each channel on the SSME TVC actuators is shown as blank (no bypass), '↓' (bypassed), and 'M' (invalid data).

OPS G6 (ABORTS)

PAGE

OPS 6011 XXXXXX TRAJ.....(SEE GNC, OPS G1, PAGE 3-4)  
OPS 6021 VERT SIT 1 .....(SEE GNC, OPS G3, PAGE 3-64)  
OPS 6031 VERT SIT 2 .....(SEE GNC, OPS G3, PAGE 3-67)  
DISP 18 GNC SYS SUMM 1 .....(SEE GNC, OPS G2, PAGE 3-22)  
SPEC 23 RCS.....(SEE GNC, OPS G2, PAGE 3-35)  
SPEC 50 HORIZ SIT .....(SEE GNC, OPS G3, PAGE 3-68)  
SPEC 51 OVERRIDE .....(SEE GNC, OPS G1, PAGE 3-12)  
SPEC 53 CONTROLS .....(SEE GNC, OPS G3, PAGE 3-75)

OPS G6  
(ABORTS)

This Page Intentionally Blank

OPS G8 (ON-ORBIT VEHICLE UTILITY)

OPS G8  
(ON-ORBIT VU)

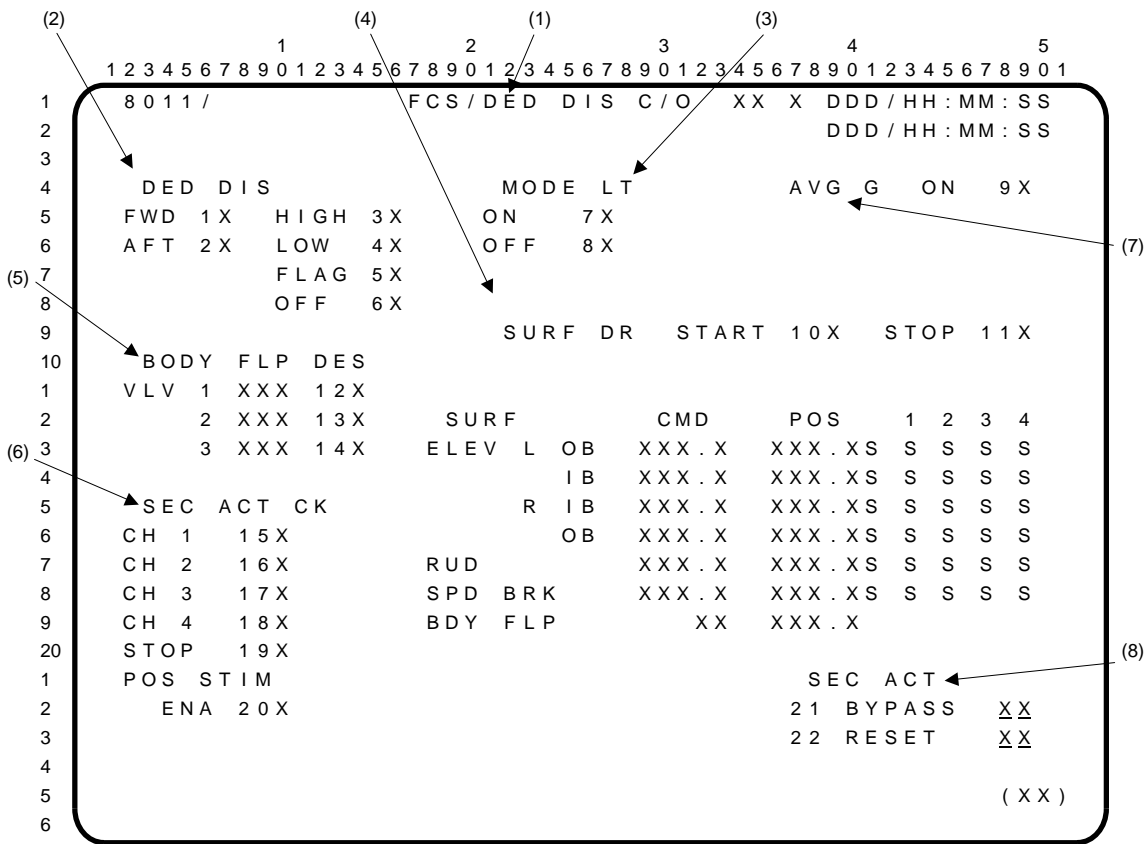

- (1) FCS/DED DIS C/O. A Guidance, Navigation, and Control (GNC) Operational Sequence (OPS) display available in OPS 8 (OPS 8011). It provides an interface to initiate and monitor the Dedicated Display checkout (DED DIS), the Mode Light test (MODE LT), the Aerosurface Drive test (SURF DR), and the Secondary Actuator Check (SEC ACT CK). If this OPS is overlaid with a Specialist Function (SPEC), any tests that are active continue; however, when the OPS is terminated by calling another OPS, all tests underway are terminated in an orderly fashion.
- (2) DED DIS. Items 1 and 2 select forward station displays (FWD) and aft station displays (AFT), respectively, and are mutually exclusive. The display is initialized with the FWD selected. The selected station is indicated by an "\*" next to the appropriate item number. The capability exists to drive the Attitude Direction Indicator (ADI), Altitude/Vertical Velocity Indicator (AVVI), Alpha/Mach Indicator (AMI), Horizontal Situation Indicator (HSI), and Surface Position Indicator (SPI) with high and low values as well as present all error flags. Items 3 thru 6 allow the mode selection for HIGH, LOW, FLAG, and OFF, respectively. They are mutually exclusive, and the active item is indicated by an "\*" next to the number.
- (3) MODE LT. This allows the General Purpose Computer (GPC) interface with the AUTO, Control Stick Steering (CSS), DIR, AUTO/MAN, and FCS MODE LTs to be checked. Controls for the MODE LT interface test allow turning the lights ON (item 7) and turning them OFF (item 8). Items 7 and 8 are mutually exclusive, and the active item is indicated by an "\*" next to the item number.
- (4)\* SURF DR. A SURF DR is available to check the GPC capability to drive the aerosurfaces and to warm the hydraulic fluid. The controls for the SURF DR allow the START (item 10) and STOP (item 11) of the aerosurface drive function. Items 10 and 11 are mutually exclusive, and item 10 is mutually exclusive with items 15 thru 18. The active control is indicated by an "\*" next to the item number. The display is initialized with neither item selected. An output command (CMD) and selected position (POS) feedback are displayed for each aerosurface (SURF). Outputs for the elevons (ELEV) and rudder (RUD) are displayed in degrees with the direction of trailing edge deflection shown as 'U' (up) and 'D' (down) for the ELEV, and 'L' (left) and 'R' (right) for the RUD; speed brake (SPD BRK) outputs and positions are in percent of full deflection; CMD position for body flap (BDY FLP) is UP, DN (down), or blank; and the BDY FLP POS value is displayed in percent of full deflection. The status indicator after POS for ELEV, RUD, and SPD BRK will be a '↓' if predetermined limits between CMD and POS are exceeded during the aerosurface drive test.

FCS/DED DIS C/O (Cont):

The port status for channels 1, 2, 3, and 4 on all appropriate aerosurfaces is displayed as blank (no bypass), '↓' (bypass), or 'M' (data missing).

- (5) BODY FLP VLV. Controls and status of the body flap pilot valves (BODY FLP VLVs) are presented for each valve. An 'ENA' (Enable) or 'INH' (Inhibit) is displayed corresponding to the state of the enable signal. Each BDY FLP VLV may be selectively inhibited by executing item 12, 13, or 14. An '\*' next to the item number indicates that the DES (deselect) command is active. Execution of item 12, 13, or 14 when the '\*' is present enables the item and removes the '\*'. These controls are enabled when the display is initialized in OPS 8, but the current state is maintained across other OPS transitions.
- (6)\* SEC ACT CK. Secondary actuator check (SEC ACT CK) tests the bypass feature of the actuators by issuing a command on one channel of different magnitude than the other three. This command is maintained for a time duration adequate to cause ports to bypass (at least 140 msec). Controls are provided for actuator channels CH1 thru CH4 (items 15 thru 18). Execution of item 19 (STOP) terminates the test. Items 15 thru 19 are mutually exclusive, and items 15 thru 18 are mutually exclusive with item 10. An '\*' appears next to the active item number. Resetting the channels is accomplished by using the Flight Control System (FCS) channel switches. The display is initialized with item 19 selected. Item 20 (POS STIM) changes the polarity of the secondary actuator check which is performed when items 15 thru 8 are executed. An '\*' indicates positive polarity; a blank indicates negative. The display is initialized positive each time it is called.
- (7) AVG G. Item 9 turns powered flight navigation (AVG G) on or off. 'ON' results in an '\*' next to the number. This display is initialized with AVG G ON and thereafter reflects crew inputs.
- (8) SEC ACT. Entry of an aerosurface secondary actuator channel ID at item 21/22 causes a command to be issued to bypass/reset that channel. Channel ID is defined as 'XY' where 'X' is the desired aerosurface and 'Y' is the actuator channel (see table, below). Bypasses and resets initiated in OPS 8 are the initialization data for any subsequent OPS cyclic I/O. The display is initialized with items 21 and 22 as zeroes.

		Actuator Channel 'Y'			
		1	2	3	4
<u>AEROSURFACE – 'X'</u>		<u>Item 21/22 Data Entry ID</u>			
LOB ELEVON	1	11	12	13	14
LIB ELEVON	2	21	22	23	24
RIB ELEVON	3	31	32	33	34
ROB ELEVON	4	41	42	43	44
RUDDER	5	51	52	53	54
SPEEDBRAKE	6	61	62	63	64

\*PROGRAM NOTES

- (4) (6) Run ADT Prior to SEC ACT CK. The SURF DR (ADT) test should be run prior to the SEC CK because SURF DR leaves the surfaces far enough from the hardstops to ensure a valid SEC ACT CK. (DR 35572)

ADT Fault Annunciation. An 'AERO DRIVE' fault message and associated '↓' are generated when the SEC ACT CK (channel 1) is run. This is expected and can be cleared by MSG RESET on the MCDS keyboard. (DR 46503)

Actuator Bypass Down Arrows. Actuator bypass '↓'s will not appear as expected if more than 2 channels are bypassed before resetting. Bypassed channels should be reset before bypassing the next channel. (DR 44250)

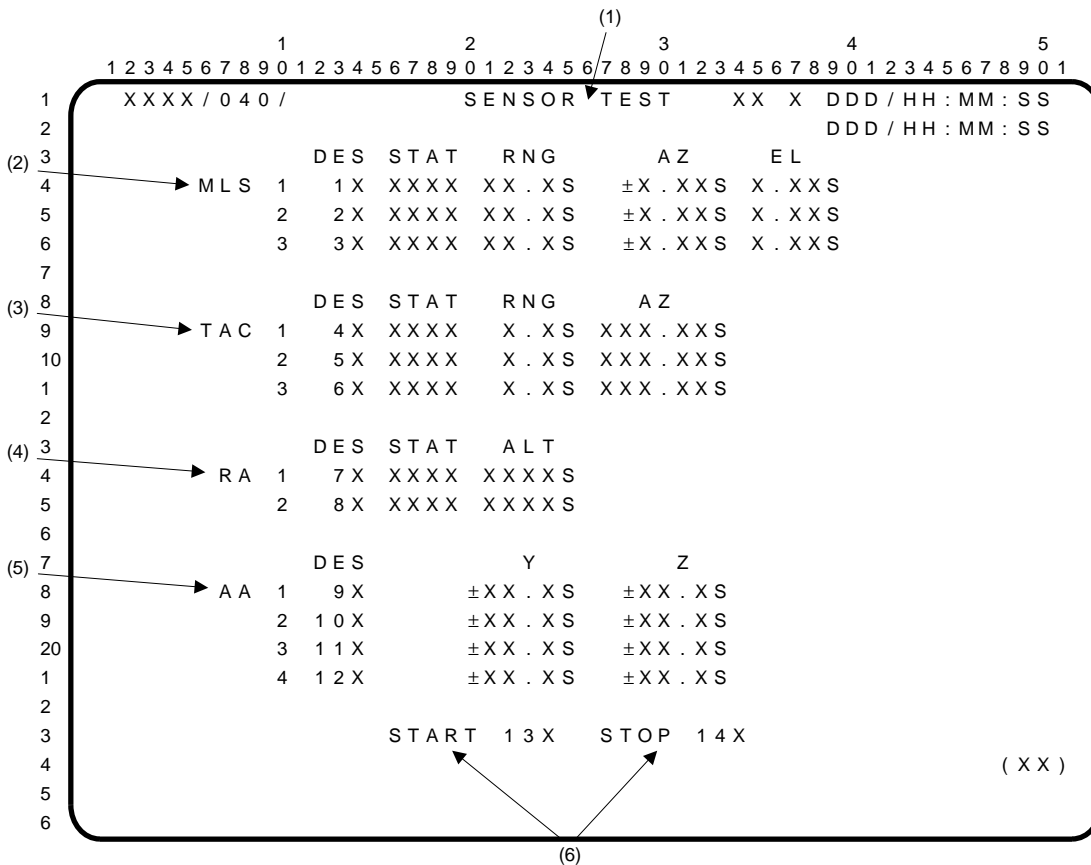

(1) **SENSOR TEST.** A GNC SPEC (SPEC 40) available in OPS 8. It provides a means of initiating, monitoring, and terminating the self-tests of the Microwave Landing System (MLS), Tactical Air Navigation (TACAN), Radar Altimeter (RA), and Accelerometer Assembly (AA) sensors. It also provides control of the SFs for each of these sensors. Execution of a DES item number changes the selection as a candidate for the SFs of the corresponding sensor. An '\*' appears next to the item number if the corresponding sensor is deselected as a candidate. The SF configuration from this display is carried over into OPS 3. A status indicator beside each test parameter can show the following:

'M'	data missing
'↑'	test value too high
'↓'	test value too low
blank	normal

(2) **MLS.** MLS status (STAT) is output as 'BITE', 'OFF', or blank. 'BITE' will be displayed when self-test is active, and the elevation-sign bit, range-sign bit, elevation-validity bit, or range-validity bit indicates a failure. When MLS self-test is not active, only the elevation or range-sign bits will drive the 'BITE' indication. If the 'BITE' indicator is set, it will be blanked if the condition is corrected. MLS STAT is run at 2 Hz. Range (RNG) in nautical miles, azimuth (AZ) in degrees, and elevation (EL) in degrees are displayed for each MLS.

(3) **TAC (TACAN).** TACAN STAT will be output as 'BITE', 'OFF', or blank. If the BITE indicator is set, 'BITE' is displayed only while the test is in progress and blanked if the condition is corrected. RNG in nautical miles and AZ in degrees are displayed for each TACAN.

(4) **RA.** RA STAT will be output as 'BITE', 'OFF', or blank. If the BITE indicator is set, the 'BITE' is latched, and reset upon the initiation of self-test STOP. Altitude (ALT) in feet is displayed for each RA.

(5) **AA.** No STAT column is provided for AA. Lateral acceleration (Y) and normal acceleration (Z) in feet per second per second are displayed for each AA.

(6) **Test Controls.** Execution of item 13 (START) initiates self-testing of all displayed sensors. An '\*' appears next to item 13 while testing is in progress and is blanked upon test completion. Execution of item 14 (STOP) after test completion removes all self-test stimuli, clears the parameter status indicators, blanks RA STAT, enables cyclic update of sensor parametric data, and displays an '\*' next to item 14. Execution of item 14 while self-test is active ('\*' at item 13) is illegal; items 13 and 14 are initialized blank.



	1										2										3										4										5																			
	1	2	3	4	5	6	7	8	9	0	1	2	3	4	5	6	7	8	9	0	1	2	3	4	5	6	7	8	9	0	1	2	3	4	5	6	7	8	9	0	1	2	3	4	5	6	7	8	9	0										
1	XXXX / 041 /										RGA / ADTA / RCS										XX X										DDD / HH : MM : SS										DDD / HH : MM : SS																			
(2) 3	DES STAT										R										P										Y																													
4	R 1	1 X	XXXX								±XX . XS										±XX . XS										±XX . XS																													
5	G 2	2 X	XXXX								±XX . XS										±XX . XS										±XX . XS																													
6	A 3	3 X	XXXX								±XX . XS										±XX . XS										±XX . XS																													
7	4	4 X	XXXX								±XX . XS										±XX . XS										±XX . XS																													
8																																																												
9	DES STAT										PS										P∞C										P∞U										P∞L										T									
(3) 10	A 1	5 X	XXXX	XX .	XXXX	XX .	XXXX	XX .	XXXX	XX .	XXXX	XX .	XXXX	XX .	XXXX	XX .	XXXX	XX .	XXXX	XX .	XXXX	XX .	XXXX	XX .	XXXX	XX .	XXXX	XX .	XXXX	XX .	XXXX	XX .	XXXX	XX .	XXXX	XX .	XXXX	XX .	XXXX	XX .	XXXX	XX .	XXXX	XX .	XXXX	XX .	XXXX	XX .	XXXX	XX .										
1	D 3	6 X	XXXX	XX .	XXXX	XX .	XXXX	XX .	XXXX	XX .	XXXX	XX .	XXXX	XX .	XXXX	XX .	XXXX	XX .	XXXX	XX .	XXXX	XX .	XXXX	XX .	XXXX	XX .	XXXX	XX .	XXXX	XX .	XXXX	XX .	XXXX	XX .	XXXX	XX .	XXXX	XX .	XXXX	XX .	XXXX	XX .	XXXX	XX .	XXXX	XX .	XXXX	XX .	XXXX	XX .										
2	T 2	7 X	XXXX	XX .	XXXX	XX .	XXXX	XX .	XXXX	XX .	XXXX	XX .	XXXX	XX .	XXXX	XX .	XXXX	XX .	XXXX	XX .	XXXX	XX .	XXXX	XX .	XXXX	XX .	XXXX	XX .	XXXX	XX .	XXXX	XX .	XXXX	XX .	XXXX	XX .	XXXX	XX .	XXXX	XX .	XXXX	XX .	XXXX	XX .	XXXX	XX .	XXXX	XX .	XXXX	XX .										
(4) 3	A 4	8 X	XXXX	XX .	XXXX	XX .	XXXX	XX .	XXXX	XX .	XXXX	XX .	XXXX	XX .	XXXX	XX .	XXXX	XX .	XXXX	XX .	XXXX	XX .	XXXX	XX .	XXXX	XX .	XXXX	XX .	XXXX	XX .	XXXX	XX .	XXXX	XX .	XXXX	XX .	XXXX	XX .	XXXX	XX .	XXXX	XX .	XXXX	XX .	XXXX	XX .	XXXX	XX .	XXXX	XX .										
4	TEST										HI 9X										LOW 10X										STOP 11X																													
5																																																												
6																																																												
(5) 7																																																												
8																																																												
9																																																												
20	RJDF										12X										TEST EXEC										15X										TEST XXXX																			
1	RJDA-A										13X										CONTINUE										16X										JET XXX																			
2	-B										14X										STOP										17																													
3																																																												
4																																																												
5																																																												
6																																									( X X )																			

- (1) RGA/ADTA/RCS. A GNC SPEC (SPEC 41) available in OPS 8. It provides a means of initiating, monitoring, and terminating the self-tests of the Rate Gyro Assembly (RGA) and Air Data Transducer Assembly (ADTA) sensors, controls of the SF for each of these sensors, and controls for performing the RCS DRIVER TEST (trickle current). Execution of a DES item number changes the selection as a candidate for the SFs of the corresponding sensor. An '\*' appears beside the item number if the corresponding sensor is deselected as a candidate. The SF configuration from this display is carried over into OPS 3. A status indicator next to each test parameter can show the following: an 'M' for missing data, a '↓' for test value too low, an '↑' for test value too high, or blank. When an 'M' is displayed, the last valid value of the parameter is displayed.
- (2) RGA. RGA STAT is output as 'SMRD' or blank. If the Spin Motor Rotation Detector (SMRD) indicator is set, the SMRD display will be latched and reset if the error condition is corrected or upon execution of STOP (item 11). Roll (R), pitch (P), and yaw (Y) in degrees per second are displayed for each RGA.
- (3) ADTA. ADTA STAT is output as 'BITE' or blank. If the BITE indicator is set, the 'BITE' display will be latched, and reset if the error condition is corrected or upon execution of STOP (item 11). Static Pressure (PS), Center Alpha Pressure (P∞C), Upper Alpha Pressure (P∞U), Lower Alpha Pressure (P∞L) in inches of mercury, as well as Total Temperature (T) in degrees Celsius are displayed for each ADTA.
- (4) TEST. Items 9 and 10 initiate either the HIGH TEST or the LOW TEST for RGAs and ADTAs. An '\*' appears next to the appropriate item number to indicate the selected test. Items 9 and 10 are initialized blank. Item 11 stops the self-test on all sensors. An '\*' appears next to the item number to indicate that the tests have been stopped. Test results are evaluated visually.
- (5) RCS DRIVERS. Items 12, 13, and 14 allow selection of the Reaction Jet Drivers Forward, Aft-group A, or Aft-group B (RJDF, RJDA-A, or RJDA-B), respectively. These items are mutually exclusive. An '\*' appears next to the item which has been selected. TEST is a status indication that will be output as 'FAIL' for a malfunction or a comm fault, 'RUN' for a test-active, and 'CPLT' for a test-complete. The jet alpha-numeric ID (JET) is output during an error in the test to identify the jet and is blanked after the execution of CONTINUE (item 16). TEST EXEC (item 15) begins the test. CONTINUE reinstates a suspended test. The test is suspended upon each error detection. An '\*' appears next to the item which is active. STOP (item 17) deselects RCS testing (i.e., deselects the jet driver group, blanks the asterisks by item 12, 13, or 14 and item 15 or 16, and blanks 'CPLT'). Item 17 is legal only when RCS DRIVERS TEST is blank or 'CPLT'.

										SWITCH / SURF										XX X DDD / HH : MM : SS									
																				DDD / HH : MM : SS									
										OR IDE					DES					OR IDE					DES				
										1	1	XS	1X	3	1	XS	7X												
										2	XS	2X	2	XS	8X														
										3	XS	3X	3	XS	9X														
FCS CH										2	1	XS	4X	4	1	XS	10X												
										2	XS	5X	2	XS	11X														
										3	XS	6X	3	XS	12X														
										P					R / Y					SPD BRK		BDY FLP							
										AUT		CSS			AUT		CSS			AUT	MAN	AUT	DES						
										L	1	XS	XS	XS	XS	XS	XS	XS	XS	XS	XS	13X							
										2	XS	XS	XS	XS	XS	XS	XS	XS	XS	XS	XS	14X							
										3	XS	XS	XS	XS	XS	XS	XS	XS	XS	XS	XS	15X							
FCS MODE										R	1	XS	XS	XS	XS	XS	XS	XS	XS	XS	XS	16X							
										2	XS	XS	XS	XS	XS	XS	XS	XS	XS	XS	XS	17X							
										3	XS	XS	XS	XS	XS	XS	XS	XS	XS	XS	XS	18X							
										L OB		L IB			R IB		R OB			RUD		SPD BRK		BDY FLP					
										1	XXX . XS	XXX . XS	XXX . XS	XXX . XS	XXX . XS	XXX . XS	XXX . XS	XXX . XS	XXX . XS	XXX . XS	XXX . XS	19X							
										2	XXX . XS	XXX . XS	XXX . XS	XXX . XS	XXX . XS	XXX . XS	XXX . XS	XXX . XS	XXX . XS	XXX . XS	XXX . XS	20X							
										3	XXX . XS	XXX . XS	XXX . XS	XXX . XS	XXX . XS	XXX . XS	XXX . XS	XXX . XS	XXX . XS	XXX . XS	XXX . XS	21X							
										4	XXX . XS	XXX . XS	XXX . XS	XXX . XS	XXX . XS	XXX . XS	XXX . XS	XXX . XS	XXX . XS	XXX . XS	XXX . XS	22X							
																				( XX )									

- (1) SWITCH/SURF display. A GNC SPEC (SPEC 42) available only in OPS 8. It includes FCS CH switch contact outputs and controls to select and deselect the switch contacts as selection filter (SF) inputs; FCS MODE switch contact outputs and controls to select or deselect the switch contacts; and SURF position deflections for each transducer and controls to select and deselect the transducers as inputs to the SFs. The DES configuration is maintained across all OPS transitions for initialization of SF processing.
- (2)\* FCS CH. An '\*' appears in the ORIDE column when any of the redundant contacts of the four FCS CH switches is sensed to be in the ORIDE position. A status discrete ('M' for missing data, blank for okay) may appear adjacent to the switch contact discrete. Items 1 thru 12 are used to select or deselect the switch contact outputs as inputs to the SFs. An '\*' next to the item number indicates deselection. Executing the item number again causes the '\*' to disappear and indicates selection.
- (3) FCS MODE. The outputs of the triply-redundant pitch (P), roll/yaw (R/Y), SPD BK, and BDY FLP switch contacts for both the left (L) and right (R) FCS MODE switches are displayed. An '\*' is shown under the switch position Auto (AUT), or CSS for P and R/Y, AUT or MAN for SPD BK, and AUT for BDY FLP, when the switch contact is sensed to be in that position. A status discrete is provided for each output as described in (2). Items 13 thru 18 are used to select or deselect the switch contact outputs as inputs to the SFs in the same manner described in (2) for items 1 thru 12. Deselection causes a set of contacts for all FCS MODE switches to be deselected.
- (4) SURF. The SURF position deflections sensed by each of four transducers for the LOB, LIB, RIB, and ROB elevons; SPD BK and BDY FLP are displayed in the lower section of the display. ELEV and RUD deflections are displayed in degrees. SPD BK and BDY FLP deflections are displayed in percent (0-99). A status discrete is provided for each output as described in (2). Items 19 thru 22 are used to provide manual control over which transducers are SF candidates in the same manner described in (2) for items 1 thru 12. Each item causes the specified transducer for all surfaces to be selected or deselected.

SWITCH/SURF (Cont):

\*PROGRAM NOTES

- (2) FCS Channel Switch Comm Fault Status. In OPS 8 (only), comm faulted FCS channel switch contacts are not removed from contact selection filtering as they should be. If FF 1, 2, or 3 failures or 'BCE STRG 1(2,3) B' bypasses occur, switch status should be closely monitored via the SPEC and ground downlist to ensure that erroneous OVERRIDE commands do not occur. (DR 30526)

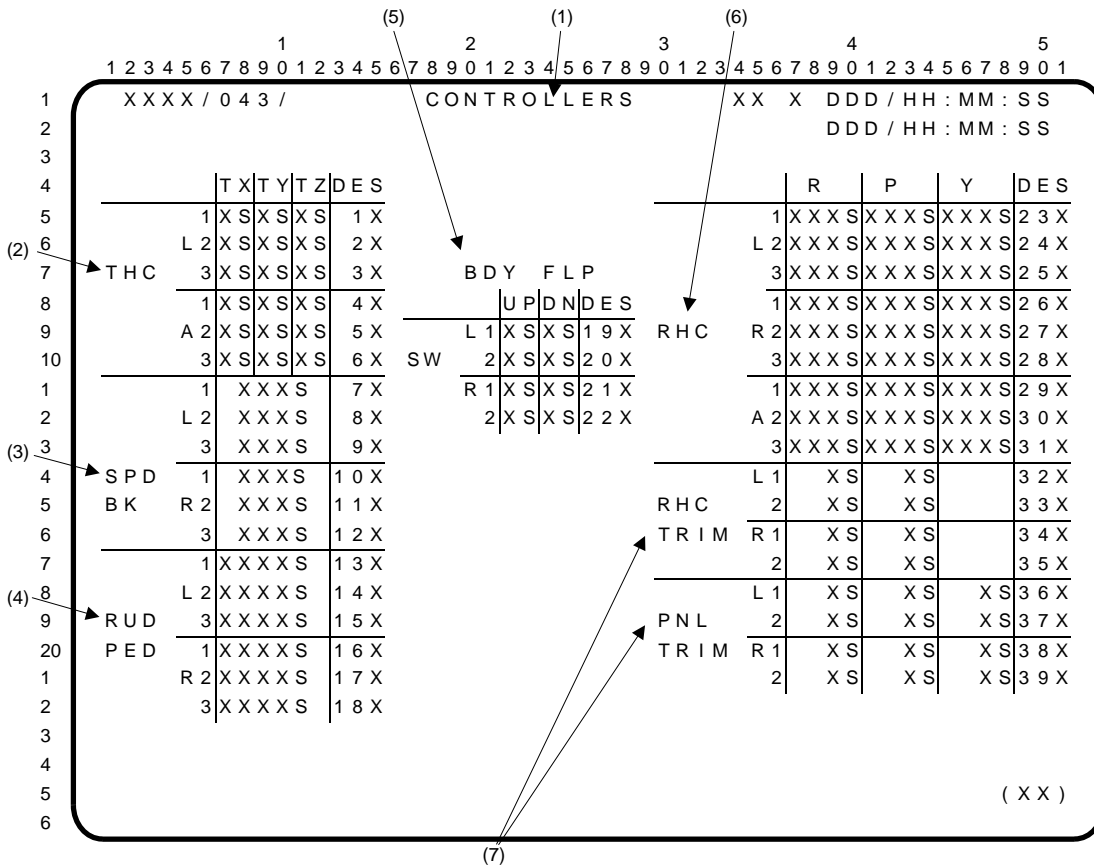

(1) CONTROLLERS display. A GNC SPEC (SPEC 43) available in OPS 8. It includes means to monitor commands from the Translational Hand Controller (THC), SPD BK controllers, rudder pedals (RUD PED), BDY FLP slew switches, Rotational Hand Controllers (RHC), and RHC and panel (PNL) TRIM switches, as well as controls to select and deselect the controller output for the selection filters (SFs).

NOTE: The following applies to all the data fields described in the following paragraphs. A status discrete to the right of each data field contains an 'M' if data are missing and a blank if data are present. Additionally, for THC and RHC, a '↓' is displayed if Redundancy Management (RM) has isolated a failure. RM cannot resolve failures in certain 2-LRU operations (miscompare), and displays a '?' for both elements in this case. Items 1 thru 39 are used to manually select and deselect controller commands to be used by their associated SFs. An '\*' next to the item number signifies deselection. Repeatedly executing an item alternately results in selection and deselection. The SFs are active only for THC and RHC in OPS 8. However, the DES configuration is maintained for transition to OPS 3 for initialization of all associated SFs.

- (2)\* THC. Commands from the left (L) and aft (A) THC transducers are displayed as a '+' or '-' (in controller axes) under TX, TY, or TZ depending on the translation deflection.
- (3) SPD BK. Commands are displayed in percent (0 to 100) of SPD BK extension.
- (4) RUD PED. RUD PED L and R commands are displayed in percent (0 to 100) of L or R RUD PED deflection.
- (5) BDY FLP. BDY FLP L and R switch (SW) contact outputs are shown as an '\*' under UP or DN when that position is sensed as commanded by the switch contacts.
- (6)\* RHC. RHC L, R, and A commands are displayed in percent of full deflection for Pitch (P) 'U' or 'D', Roll (R) 'L' or 'R', or Yaw (Y) 'L' or 'R'. Note: The U/D/L/R is referenced to the controller axes.
- (7) RHC TRIM and PNL TRIM. L and R RHC and PNL TRIM switch commands are displayed under R and P for RHC TRIM and R, P, and Y for PL TRIM. 'R' or 'L' under the R and Y columns corresponds to a right or left command. 'U' or 'D' under the P column corresponds to an up or down command. A blank under any column indicates no sensed trim command.

CONTROLLERS (Cont):

\*PROGRAM NOTES

- (2) AFT THC Data Display. The physical orientation (rotated 90 degrees clockwise) of the AFT THC causes crew commands to be displayed as follows:

THC CMD	TX	TY	TZ
PUSH	+		
PULL	-		
DOWN		+	
UP		-	
STBD			+
PORT			-

- (6) RHC Contact Deselection. When RM automatically deselected an RHC channel, it places a down arrow by the axis that experienced the failure but not by the other two axes on that channel. An '\*' will appear under the 'DES' column for that channel to indicate that all axes on that channel have been deselected.

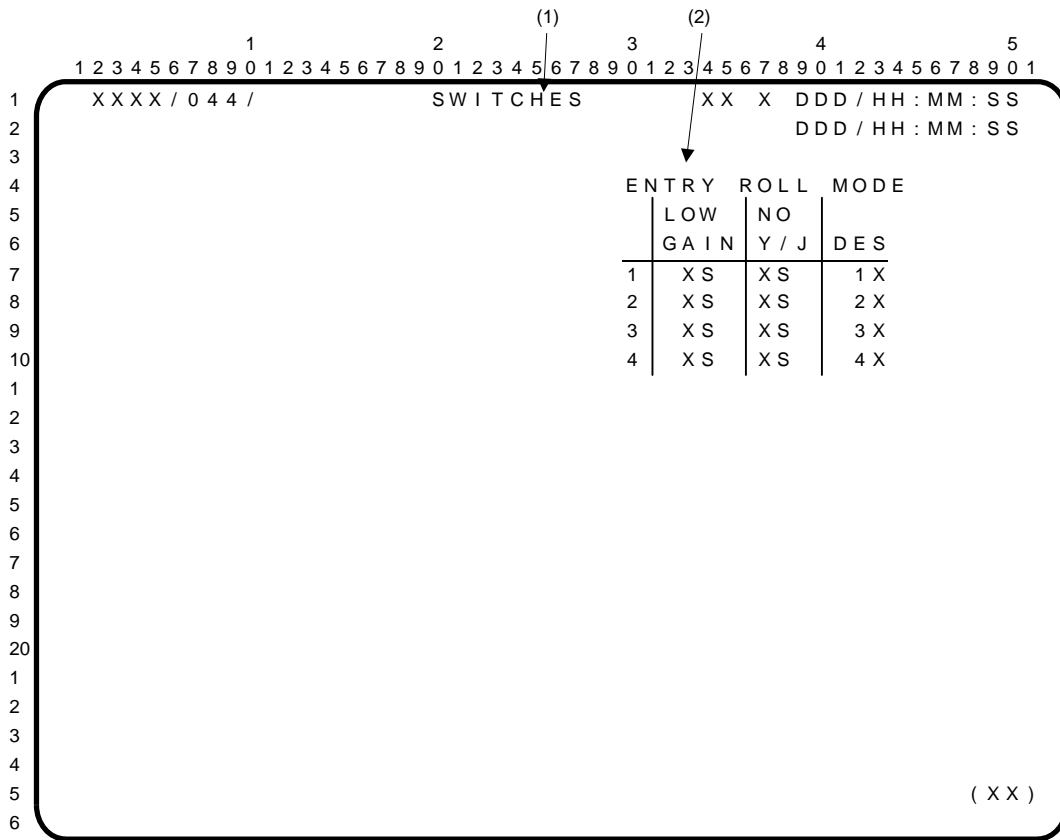

- (1) SWITCHES display. A GNC SPEC (SPEC 44) available only in OPS 8 which provides the capability to monitor and control the selection filtering of the ENTRY MODE switch.
- (2) Items 1 thru 4 are used to alternately select or deselect 'ENTRY ROLL MODE' redundant contact sets 1 thru 4 to be used as inputs to RM selection filtering. An '\*' is displayed at the item number to indicate deselection (DES) or in the 'LOW GAIN' or NO Y JET ('NO Y/J') columns to indicate that the closed position is sensed. An 'M' is displayed for each contact whenever data for that contact are missing; otherwise, the status parameter is blank.

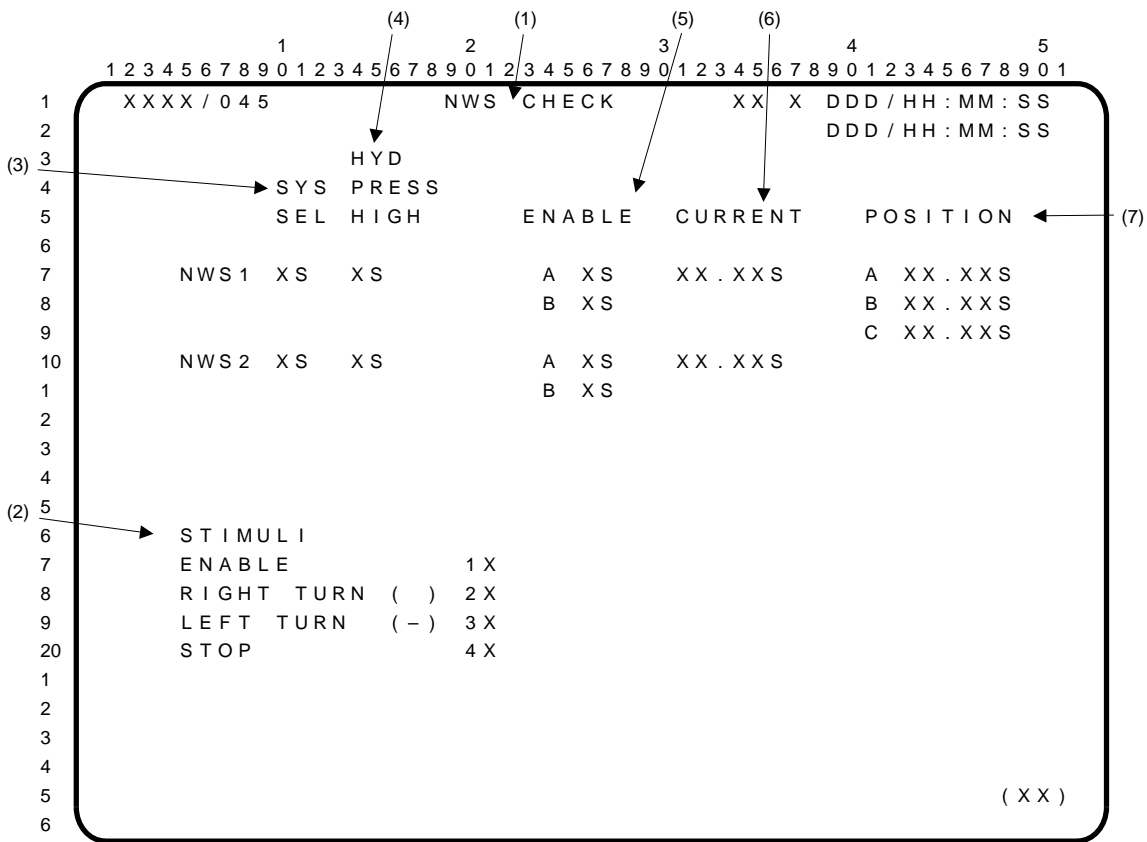

**(1)** NWS CHECK. A GNC SPEC (SPEC 45) available only in OPS 8 with the improved NWS avionics mod kit. This display provides the capability to control the Enable and Position commands to the Nose Wheel Steering (NWS) system, perform checks on the nose wheel feedback and steering position transducers, monitor the NWS system discretes and electro-hydraulic servo valve electrical current, and annunciate (Class O) out-of-tolerance conditions during the on-orbit FCS checkout.

**(2)** STIMULI. Items 1 thru 3 are used to initiate checks on the selected NWS system mode. Item 1 (ENABLE) sets the NWS Enable commands A and B to true. Item 2 (RIGHT TURN) sends a positive position steering command (I-LOAD) to the NWS control box, and item 3 (LEFT TURN) sends a negative steering position command (I-LOAD) to the NWS control box. Item 4 (STOP) halts all stimuli to the NWS. An '\*' appears next to the item (1 thru 4) currently selected. However, because these items are mutually exclusive, only one may be selected at a time. Execution of any item automatically deselects the item previously selected, and an '\*' should appear by the new item. When the display is initialized, item 4 is automatically selected, whereby the NWS position command is set to zero volts, and the NWS Enable commands are set to false.

NOTE: Parameter status indicators (PSIs) are displayed directly to the right of most of the respective data fields described below. An 'M' is displayed if data for a field is missing or has been comm faulted. A '↓' is displayed if data for a field is outside of a predefined tolerance or is unexpected. The PSI field is blank if the data parameter is within its predefined limits or if it is an expected value.

**(3)** SYS SEL. An '\*' by NWS1 or NWS2 indicates the selected position of the NWS mode switch on panel L2. If the switch is in the OFF position, both fields will be blank. An 'M' is displayed in the adjacent PSI field if the data field path has been comm faulted by the flight control operating system (FCOS); otherwise, the PSI field is blank. An anomalous condition exists if an '\*' appears by both SYS SEL fields, although the display will not annunciate an out-of-tolerance condition for this case.

## NWS CHECK (Cont):

- (4)** HYD PRESS HIGH. The status of the NWS steering engaged valve (hydraulic pressure switch) is indicated by data in the two HYD PRESS HIGH fields. Selection of the NWS mode switch determines which contacts of this valve switch will be tested. During normal NWS operation, hydraulic pressure downstream of the ENABLE valves causes the steering engaged valve to actuate; the switch contacts on the valve then close, providing a high (active) signal to the Nose Wheel Position SOP, and grounding the NWS Failed Discrete and Fail Light. However, because hydraulic pressure is isolated from the NWS actuator on orbit, this valve should not activate during the OPS 8 check. An '\*' in either of the HYD PRESS HIGH data fields indicates that the valve is in its actuated position, or that it has incurred a switch contact failure. An 'M' displayed directly to the right of either of these data fields indicates that the respective data path has been comm faulted by the FCOS. For all other conditions, these two PSIs will be blank.
- (5)** ENABLE. Item 1 (ENABLE) sets the NWS Enable commands A1(2) and B1(2) to true, depending on the selected mode of NWS. (NWS1 and NWS2 modes are selected by the NWS mode switch.) By executing this item, the GNC GPCs transmit the appropriate enable commands (A1, B1 or A2, B2) to the NWS control box avionics and pilot valves, using the same flight critical MDM channelization as used during rollout. Upon execution of item 1, an '\*' should appear next to this item. Good enable command paths are verified if an '\*' is displayed in the appropriate NWS ENABLE fields. For each Enable discrete, an 'M' will be displayed in the PSI field if the expected data are missing, or a '↓' will be displayed if the function is failed. The PSI field will be blank for good data. The selected mode of NWS is NO-GO unless both enables are good, since both enables are required to satisfy the NWS pilot valve logic, and thereby enable hydraulics to the actuator.
- (6)** CURRENT. The electro-hydraulic servo-valve excitation current for the selected NWS mode and stimulus is displayed in milliamperes (mA). If the NWS switch is selected to 1 or 2, and the display is initialized (item 4 selected) or item 1 is selected, the NWS position commands are set to zero volts (null command). The NWS actuator feedback transducers are nominally biased -0.44 volts (about +1° in the stowed and locked nose wheel position), so that transducer null failures may be detected on orbit. Therefore, prior to sending a RIGHT TURN (item 2) or LEFT TURN (item 3) command, the indicated electrical current is the current associated with this transducer bias. An 'M' in the PSI field indicates that the data path for the servo-valve current has been comm faulted. A '↓' will be displayed if the current is outside of its predefined limits. The PSI will be blank if the current is good and the data path has not been comm faulted.
- (7)** POSITION. The steering position transducer (SPT) signals, conditioned by the steering position amplifiers (SPAs), indicate the true stowed nose wheel position in degrees (zero degrees). The SPTs are biased similarly to the feedback transducers. However, the nose wheel is stowed and locked on orbit and does not change position even when a RIGHT TURN (item 2) or LEFT TURN (item 3) command is executed. Therefore, the SPT/SPA signals should remain constant throughout FCS checkout. In order to preclude a 0° transducer reading at the stowed position from masking a null failure of one of these transducers, the SPTs are biased -0.42 volts (about +1° at the stowed and locked nose wheel position). A scale factor is applied to the SPT/SPA signals to convert the readings from volts to degrees; then, a bias is added to compensate for the built in -0.42 volts transducer off-set. The results are displayed in the position field, in degrees. If the absolute value of any position is >0.75°, a '↓' will appear in the respective PSI field, directly to the right of the value. An 'M' in a PSI field indicates that the data path for that value is missing (e.g., I/O error, LRU failure, etc.). A blank PSI field indicates that the position is good, and that the data path is not missing.



OPS G9 (PREFLIGHT VEHICLE UTILITY)

OPS G9  
(PREFLT VU)

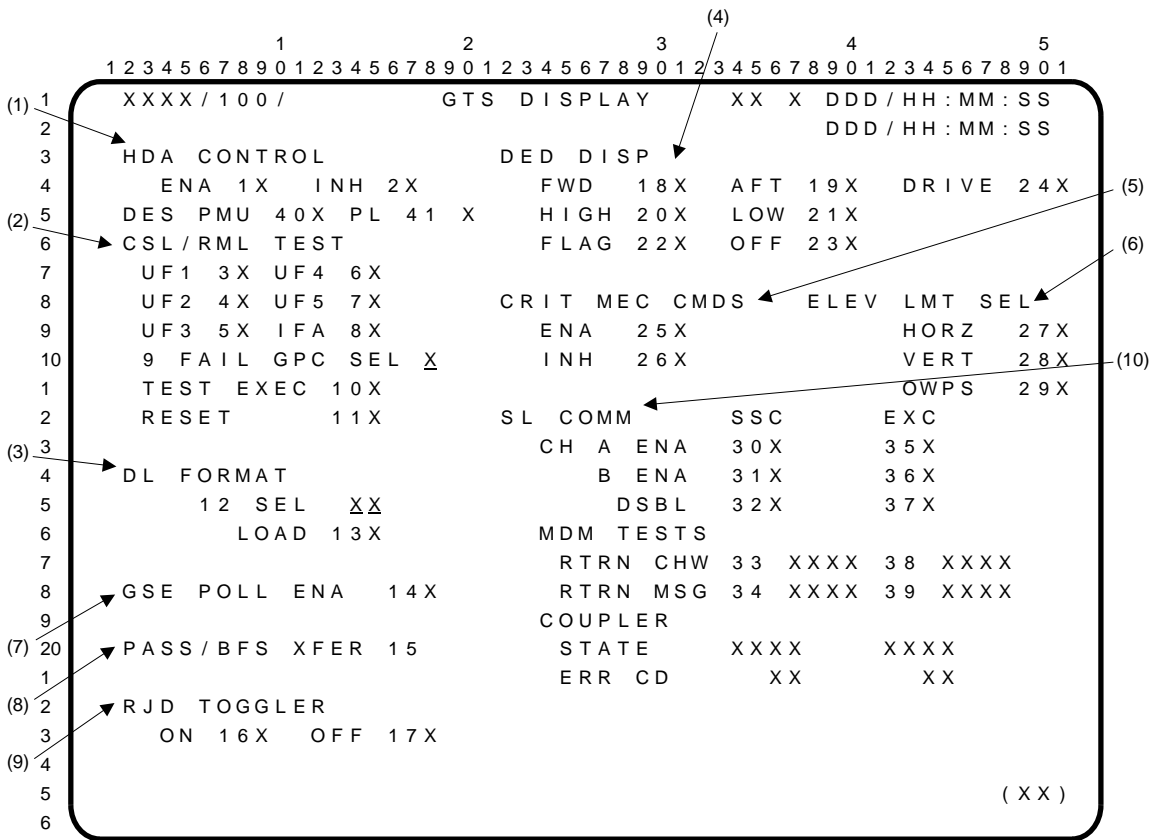

General Test Support (GTS) display is a specialist function (SPEC 100) available in OPS 9 in GNC or PL major functions. Includes **(1)** control of Housekeeping Data Acquisition (HDA) and (in G9 only) PCMMU/PL data acquisition, **(2)** Computer Status Lights (CSL) and RM Logic testing, **(3)** downlist format selection, **(4)** testing of dedicated displays, **(5)** use of critical master events controller (MEC) commands, **(6)** elevon position limit, **(7)** GSE polling, **(8)** one-shot PASS/BFS transfer, **(9)** RJD toggler, and **(10)** Spacelab Communication (SL COMM) control and monitoring.

**(1)** Items 1 and 2 enable and inhibit, respectively, housekeeping data acquisition. An '\*' indicates the item selected. Selecting item 1 blanks the '\*'s beside item 40 in OPS G9 and P9 and beside item 41 in G9 (an '\*' is always displayed beside item 41 in P9). Selecting item 2 puts an '\*' beside item 40 in G9 and P9, and beside item 41 in G9.

Items 40 and 41 control collection of PCMMU and PL data, respectively, during HDA processing in G9 only. Both are toggle items which, when selected, cause associated I/O to cease and an '\*' to appear next to the selected item. The next selection of that item restarts the I/O and blanks the '\*'. Upon transition to G9 both items 40 and 41 are initialized with their '\*'s blanked, indicating that PCMMU and PL data are being acquired. If either item is attempted in G9 with item 2 (HDA INH) active, or in PL OPS 9, an ILLEGAL ENTRY message will result.

**(2)** Items 3 thru 7 (UF 1 thru 5) select GPC 1 thru 5 (voting GPCs) UFAIL light row of the CAM. Item 8 (IFA) selection causes the IFAIL (diagonal) light for the GPC selected in item 9 to turn on. Items 3 thru 8 toggle, and selection(s) is (are) indicated by an '\*' (item 8 is mutually exclusive with items 3 thru 7 and 9). Item 9 plus inputs of 1 to 5 select the GPC to be voted against (or declare itself failed) which determines the CAM column light. Item 10 initiates testing as determined by selections made in items 3 thru 9. Item 11 execution deselects items 3 thru 8 and turns CAM lights off. CAM lights remain on until item 11 is executed or new SPEC/OPS is selected. Selection of item 10 or 11 is indicated by an '\*'. An '\*' by item 10 is blanked upon execution of any item 3 thru 9, or item 11. An '\*' by item 11 is blanked upon execution of any item 3 thru 10.

**(3)** Item 12 +X X EXEC selects downlist format ID XX for loading.

Item 13 loads format XX.

OPS G9  
(PREFLT VU)

## GTS DISPLAY (Cont):

- (4)** Items 18 thru 24 control dedicated display testing. A set of selected values drives the ADIs, AMIs, AVVIs, HSI, and SPIs through the FORWARD (FWD) DDU (item 18) and AFT DDU (item 19), respectively. High value, low value, and flag tests are initiated by selecting items 20, 21, and 22, respectively. Item 24 selects the drive test values and item 23 terminates any test in progress. Items 18, 19, and 20 thru 23 are mutually exclusive.
- (5)** Items 25 and 26 enable and inhibit, respectively, TCS critical commands to the MEC.
- (6)** Items 27 and 28 select HORIZ or VERT elevon position low limits and drive rate limit for a horizontally or vertically positioned vehicle. Item 29 provides an additional set of elevon position high/low limits and drive rate limit to be used with the Orbiter Weather Protection System (OWPS). Items 27 thru 29 are mutually exclusive and the display is initialized with item 29 selected.
- (7)** Item 14 enables GSE polling.
- (8)** Item 15 enables a transfer of initialization data from the PASS to the BFS. Must be used with the BFS MEMORY display (BFS, OPS 0).
- (9)** Items 16 and 17 send RJD TOGGLER CMD A ON or OFF commands to all RCS jets simultaneously (in GNC OPS 9 only). Items are mutually exclusive and an '\*' indicates selected item.
- (10)** Items 30 and 35 (CH A ENA) initialize polling of the Spacelab Subsystem Computer (SSC) and the Spacelab Experiment Computer (EXC), respectively, using Channel A. Items 31 and 36 (CH B ENA) perform the same function, respectively, using Channel B. Items 32 and 37 (DSBL) terminate polling for the SSC and EXC, respectively. Items 30 thru 32 are mutually exclusive for the SSC and items 35 thru 37 are mutually exclusive for the EXC. An '\*' is displayed next to the currently selected item number for each computer. Items 33 and 38 allow an MDM return command header word test to be performed on the SSC and EXC, respectively. Test results are displayed as 'FAIL' or blank if good. Items 34 and 39 (RTRN MSG) allow an MDM return message test to be performed on the SSC and EXC, respectively. Test results are displayed as 'FAIL' or blank if good. The contents of the COUPLER status word (STATE, ERR CD) are displayed to indicate if communication has been achieved with the SSC/EXC computers. The text displayed for STATE is 'BUSY', 'RSET' (reset), 'HALT', 'BITE', or 'CPLT' (complete). Error code ('ERR CD') outputs are displayed in decimal.

										1										2										3										4										5									
1	2	3	4	5	6	7	8	9	0	1	2	3	4	5	6	7	8	9	0	1	2	3	4	5	6	7	8	9	0	1	2	3	4	5	6	7	8	9	0	1	2	3	4	5	6	7	8	9	0										
1	XXXX / 101 /										SENSOR SELF-TEST										XX X										DDD / HH : MM : SS																												
2																															DDD / HH : MM : SS																												
(1) 3																																																											
4											ENA STAT RNG AZ EL																																																
5	M 1										1 X XXXX XX . XS										± X . XXS X . XXS																																						
6	L 2										2 X XXXX XX . XS										± X . XXS X . XXS																																						
7	S 3										3 X XXXX XX . XS										± X . XXS X . XXS																																						
8																																																											
(2) 9											ENA STAT RNG AZ																																																
10	T 1										4 X XXXX X . XS										XXX . XXS																																						
1	A 2										5 X XXXX X . XS										XXX . XXS										TEST CONTROL :																												
2	C 3										6 X XXXX X . XS										XXX . XXS										START 13 X																												
3																															AUTO SEQ 14 X																												
(3) 4											ENA STAT ALT																				TERM 15 X																												
5	R 1										7 X XXXX XXXXS																																																
6	A 2										8 X XXXX XXXXS																				INH ALL 16 X																												
7																																																											
(4) 8											ENA										Y										Z																												
9	A 1										9 X										± XX . XS										± XX . XS																												
20	A 2										10 X										± XX . XS										± XX . XS																												
1											3										11 X										± XX . XS																												
2											4										12 X										± XX . XS																												
3																																																											
4																																																											
5																																																											
6																															( X X )																												

SENSOR SELF-TEST is a specialist function (SPEC 101) which is available in GNC OPS 9. This display provides the means to enable self-testing of the Microwave Scan Beam Landing System (MSBLS), the Tactical Air Navigation (TACAN), the Radar Altimeters (RA), and Accelerometer Assemblies (AA).

Execution of items 1 thru 12 enables LRUs for testing. Any number of these sensors may be enabled at once. An '\*' is displayed beside those items selected for testing. The Test Status (STAT) is displayed for LRUs except AA as follows: blank for normal, 'OFF' for power off, and 'BITE' for internal hardware failure. 'BITE' is blanked whenever the condition is cleared. A status indicator beside each test parameter will show one of the following: blank for normal, '↓' for data exceeding low limit, and '↑' for data exceeding high limit.

- (1) Items 1 thru 3 enable an MSBLS for self-test on range (RNG) in nautical miles, azimuth (AZ) in degrees, and elevation (EL) in degrees.
- (2) Items 4 thru 6 enable a TACAN for self-test on RNG in nautical miles and AZ in degrees.
- (3) Item 7 or 8 enables an RA for self-test in altitude (ALT) in feet.
- (4) Items 9 thru 12 enable an AA for self-test in lateral acceleration (Y) in feet per second per second and normal acceleration (Z) in feet per second per second.
- (5) TEST CONTROL. Item 13 (START) initiates self-testing on the enabled sensors. If none are enabled, this item will do a search, then complete. Selection of item 13 drives an '\*' which blanks when testing is completed. Item 14 (AUTO SEQ) initiates self-testing on all twelve sensors whether enabled or not. Item 15 (TERM) terminates testing and inhibits all twelve sensors from self-test. Execution of item 13 or 14 with testing in progress or after test completion is illegal unless item 15 is entered first.
- (6) Item 16 (INH ALL) inhibits all twelve sensors from self-test. Execution of item 16 when item 13 or 14 is selected is illegal.

	1										2										3										4										5																													
	1	2	3	4	5	6	7	8	9	0	1	2	3	4	5	6	7	8	9	0	1	2	3	4	5	6	7	8	9	0	1	2	3	4	5	6	7	8	9	0	1	2	3	4	5	6	7	8	9	0																				
1	XXXX / 102 /										RCS / RGA / ADTA										TEST XX X										DDD / HH : MM : SS																																							
2																															DDD / HH : MM : SS																																							
3	RCS DRIVERS																																																																					
(1) 4	R J D F										1 X										START TEST										4 X										STAT XXXX																													
5	R J D A - A										2 X										CONT										5 X										JET XXX																													
6	- B										3 X										TERM										6										STEP X																													
7																																																																						
8																																																																						
9																																																																						
10																																																																						
11	SENSORS																				TEST CONTROL :																																																	
(2) 2	ENA STAT										R										P										Y										HIGH START 15 X																													
3	R 1										7 X XXXX										±XX.XS										±XX.XS										±XX.XS										AUTO SEQ 17 X																			
4	G 2										8 X XXXX										±XX.XS										±XX.XS										±XX.XS										TERM 18 X																			
5	A 3										9 X XXXX										±XX.XS										±XX.XS										±XX.XS																													
6	A 4										10 X XXXX										±XX.XS										±XX.XS										±XX.XS										INH ALL 19 X																			
(3) 7																																																																						
8																																																																						
9	ENA STAT										P ∞ C										P S										P ∞ U										P ∞ L										T T																			
20 1	A 1										11 X XXXX										XX.XXXS										XX.XXXS										XX.XXXS										XX.XXXS										XXX.XXS									
1	D 3										12 X XXXX										XX.XXXS										XX.XXXS										XX.XXXS										XX.XXXS										XXX.XXS									
2	T 2										13 X XXXX										XX.XXXS										XX.XXXS										XX.XXXS										XX.XXXS										XXX.XXS									
3	A 4										14 X XXXX										XX.XXXS										XX.XXXS										XX.XXXS										XX.XXXS										XXX.XXS									
4																																																																						
5																																																																						
6																																																																						

RCS/RGA/ADTA TEST is a specialist function (SPEC 102) which is available in GNC OPS 9. This display provides the means to enable testing of reaction jet drivers, rate gyro assemblies, and air data transducer assemblies.

### RCS DRIVERS

- (1) Items 1 thru 3 select a group of reaction jet drivers for testing. More than one group may be selected at one time (when STAT shows blank or 'CPLT').
- (2) Item 4 initiates testing on the selected group or groups of reaction jet drivers. Testing is done serially.

Item 5 continues testing that has halted because of jet driver failure.

Item 6 terminates testing, deselects all three groups of jet drivers, and blanks all '\*'s and other parameters associated with RCS DRIVERS. Item 6 is legal only when an '\*' shows beside any item 1 thru 4 and STAT shows 'FAIL' or 'CPLT'.

- (3) STAT shows: 'RUN' for testing under way; 'FAIL' for failure of a jet driver under test, or a comm fault; 'CPLT' for completion of testing on selected groups; or blank.

JET shows: the jet identification that has failed when STAT shows 'FAIL'. The first character designates the general location of the failed jet as F (forward), L (left), or R (right); the second character is a numeral giving the jet manifold number; the third character describes the thrust direction as L (left), R (right), U (up), D (down), F (forward), or A (aft).

STEP shows: the number following step indicates the point at which the test failed.

### SENSORS

The test data for each sensor are listed. More than one sensor, items 7 thru 14, may be in the enabled state at one time. The sensor test status (STAT) is displayed as follows:

- blank – normal
- 'BITE' – internal hardware failure (for ADTA only)
- 'SMRD' – spin-motor rotation detection error (for RGA only)

## RCS/RGA/ADTA TEST (Cont):

A status indicator beside each parameter will show one of the following: blank for normal, '↓' for data exceeding low limit, and '↑' for data exceeding high limit.

- (4)** Items 7 thru 10 enable a Rate Gyro Assembly (RGA) for self-testing on roll rate (R), pitch rate (P), and yaw rate (Y). Rates are displayed in deg/sec.
- (5)** Items 11 thru 14 enable an Air Data Transducer Assembly (ADTA) for self-test in Center Alpha Pressure ( $P_{\infty C}$ ), Static Pressure (PS), Upper Alpha Pressure ( $P_{\infty U}$ ), Lower Alpha Pressure ( $P_{\infty L}$ ), and Total Temperature (TT). Pressures are displayed in inches-Hg and temperatures in degC.
- (6)** TEST CONTROL. Item 15 initiates self-testing with high values on the enabled sensors (items 7 thru 14, marked with '\*s'). Item 16 initiates self-testing with low values on the enabled sensors. If no sensors are enabled, this function will do a search, then complete. Item 17 initiates self-testing with both high and low values on all eight of these sensors. Execution of item 15, 16, or 17 is illegal when testing is in progress or after a test has been completed unless TERM (item 18) is entered first. Item 18 inhibits testing all eight of these sensors (blanks all '\*s' beside items 7 thru 14). Item 18 is legal only after test results have been displayed for all sensors selected for testing.
- (7)** Item 19 inhibits all of the sensors (items 7 thru 14) with regard to self-testing. Its selection causes the '\*' to appear beside 19 and to be removed from items 7 thru 14. Item 19 is legal only when item 15, 16, or 17 is not selected.

	1									2									3									4									5																						
	1	2	3	4	5	6	7	8	9	0	1	2	3	4	5	6	7	8	9	0	1	2	3	4	5	6	7	8	9	0	1	2	3	4	5	6	7	8	9	0	1	2	3	4	5	6	7	8	9	0	1	2	3	4	5	6	7	8	9
1	XXXX / 104 /									GND IMU CNTL / MON									XX X									DDD / HH : MM : SS									DDD / HH : MM : SS																						
3	IMU									1									2									3																															
4	X	1	XX	X	.XX					X	4	XX	X	.XX						X	7	XX	X	.XX						SEL	IMU	1	16	X																									
5	Y	2	XXX	.XX						5	XXX	.XX							8	XXX	.XX																		2	17	X																		
6	Z	3	XXX	.XX						6	XXX	.XX							9	XXX	.XX																		3	18	X																		
7																																																											
8		O	XXX	.XX						XXX	.XX								XXX	.XX									ATT	DET									19	X																			
9		M	XXX	.XX						XXX	.XX								XXX	.XX									HNGR	CAL	A								20	X																			
10		I	XXX	.XX						XXX	.XX								XXX	.XX																			B	21	X																		
11		IR	XXX	.XX						XXX	.XX								XXX	.XX																			C	22	X																		
12		V	X	±XX	.XX					±XX	.XX								±XX	.XX									PREFLT	CAL									23	X																			
13		Y	±XX	.XX						±XX	.XX								±XX	.XX									GYROCOMP										24	X																			
14		Z	±XX	.XX						±XX	.XX								±XX	.XX									XXXX	XXXX																													
15		VRSS	XX	.XX						XX	.XX								XX	.XX									INERTIAL										25	X																			
16																													PLAT	POS									26	X																			
17		B	HDW	XXXX						XXXX									XXXX										TERM / IDLE										27	X																			
18		I	S / W	XX						XX									XX										28	MM	WRITE								X																				
19		T	STAT	XX						XX									XX																																								
20																																																											
21		PWR	ON	X						X									X										MM	STATUS	XXXX																												
22		I / O	S							S									S										GENIMU										31	X																			
23		STBY	10	X						11	X								12	X									30	SITE	SEL								X																				
24		OPER	13	X						14	X								15	X									ACTUAL										XXX																				
25																																							(XX)																				

GND IMU CNTL/MON is a specialist function (SPEC 104) available in GNC OPS 9. This display supports IMU ground calibration, attitude determination, platform positioning, gyrocompassing, inertial, and TERM/IDLE functions. In addition, this display provides for a Mass Memory Read or Write of calibration parameters.

- (1) Entry of values for items 1 thru 9 (in degrees) provides Euler angles defining the NAV-base to cluster transformation for Inertial Measurement Units (IMUs) 1, 2, and 3 to support the platform positioning function.
- (2) Display of outer (O), middle (M), inner (I), and inner roll (IR) gimbal angles (in degrees) for each IMU; individual accelerometer delta velocity ( $\Delta V_X$ ,  $\Delta V_Y$ ,  $\Delta V_Z$ ) in feet per second per second in cluster coordinates for each IMU; and RSS delta velocity ( $\Delta VRSS$ ) in feet per second per second for each IMU.
- (3) BITE status words in hexadecimal for each IMU.
- (4) Power-on status for each IMU; blank indicates power off while an '\*' indicates power on. I/O status for each IMU; blank for normal and 'M' for missing data.
- (5)\* Execution of items 10, 11, and 12 places IMU 1, 2, and 3, respectively, in the standby (STBY) mode. Execution of items 13, 14, and 15 places IMU 1, 2, and 3, respectively, in the operate (OPER) mode. An '\*' is displayed beside any executed item.
- (6) Execution of items 16, 17, and 18 selects IMUs for calibration/alignment and mass memory read/write. An '\*' is displayed next to any executed item.
- (7) Execution of items 19 thru 26 initiates the calibration/alignment procedures. An '\*' is displayed beside any executed item, and any '\*' displayed beside any other of items 19 thru 26 is blanked. Under item 24, 'FAIL' is displayed if the alignment-goodness test fails; 'CPLT' is displayed when the velocity and tilt test is completed. Execution of item 27 terminates calibration/alignment procedures.

GND IMU CNTL/MON (Cont):

- (8) Execution of 'ITEM 28 +1(2,3)' initiates a mass memory write of calibration parameters to mass memory area 1, 2, or 3 for selected IMU(s). Item 29 initiates a mass memory read of calibration parameters for all selected IMUs. Items 28 and 29 are valid only when item 27 is selected. MM STATUS will show 'IP' (in progress), 'FAIL' (checksum fail or I/O fail), 'CMPT' (complete error free), or blank. IMU calibration data will not be updated by the MM read if MM STATUS is 'FAIL'.
- (9) Execution of 'ITEM 30 +1(2 thru 9)' causes predefined IMU SITE dependent data from a look-up table to be utilized by the IMU software. Item 30 is valid only when the IMUs are in TERM/IDLE (\*\* beside item 27). The ACTUAL site selected is displayed below SITE SEL (entries 1 thru 9 are associated with sites 39A, VAS, OPF, JSC, PMD, DNY, 39B, LC6, and OMC, respectively). An 'ILLEGAL ENTRY' message will be generated if an attempt is made to enter a value other than 1 thru 9 or execute item 30 when the IMUs are not in TERM/IDLE.
- (10) Execution of item 31 loads the generic IMU calibration parameters for the selected IMU(s). An 'ILLEGAL ENTRY' error message will be displayed if selected IMU(s) is not in TERM/IDLE mode (ITEM 27\*) or if no IMU is selected.

\*PROGRAM NOTES

- (5) IMU Commands during BTU Testing. Execution of items 13 thru 15 during BTU level 2 testing (ref. SPEC 112, item 26) will result in an 'ILLEGAL ENTRY' message and all IMUs will remain in the STBY mode.



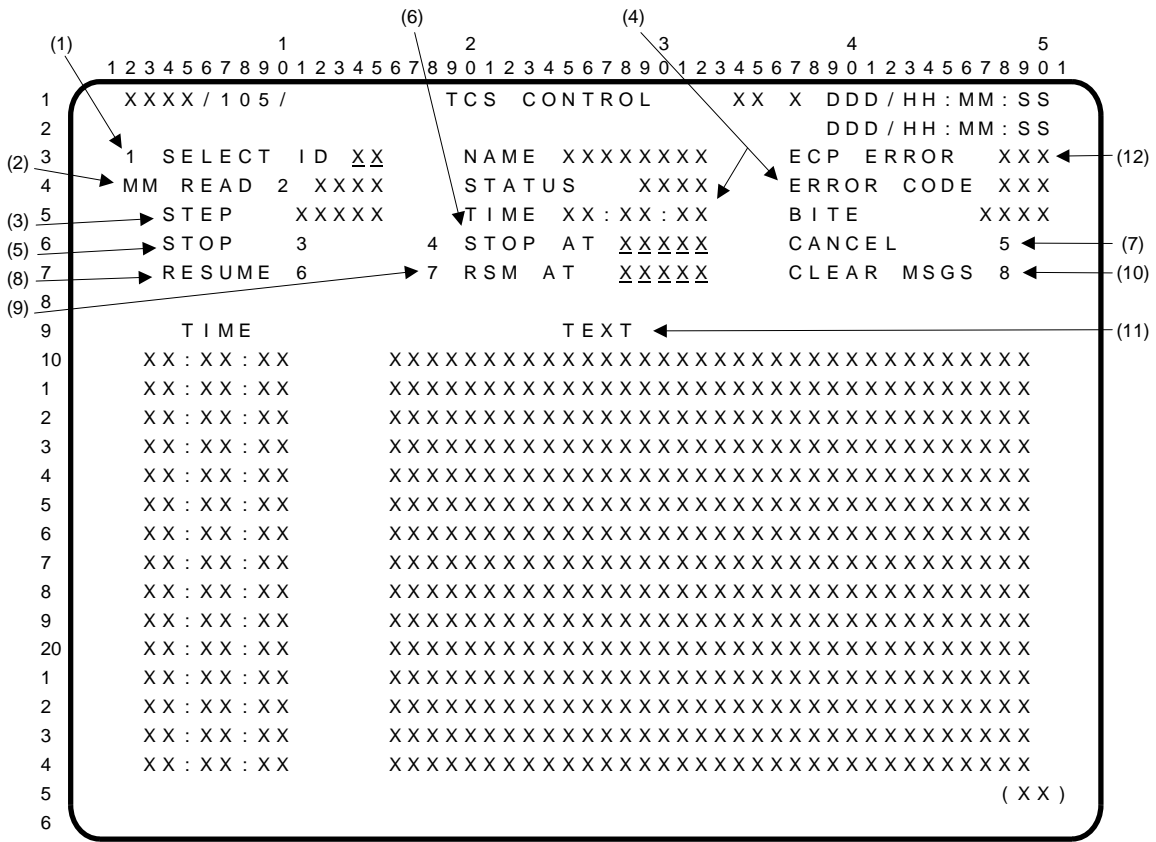

Test Control Supervisor (TCS CONTROL) display is a specialist function (SPEC 105) available in GNC OPS 9. This display supports the calling, execution, and interactive control of predefined test sequences which are mass memory resident.

- (1) SELECT ID. ITEM 1 +X X EXEC selects sequence XX for execution, where  $1 \leq XX \leq 64$ .  
NAME. The name corresponding to ID number XX is displayed here.
- (2) MM READ. Item 2 reads and executes the sequence identified in (1). An '\*' is displayed next to the item while the read is in progress. 'CPLT' is displayed when the sequence begins executing.
- (3) STEP. The number of the main sequence step currently executing is displayed (next if currently stopped).  
STATUS. The following status indications are displayed when the indicated conditions are met: 'RUN' if sequence is currently executing; 'SPND' if sequence is stopped for an Explicitly-Coded Program (ECP) or TCS error or TCS stop operation; 'END' after item 5 is executed or a TCS end operator is encountered.
- (4) ERROR CODE. The error code number is displayed if the sequence has stopped for an error condition. This field is blanked at the start of a new ECP or upon keyboard entry of item 5 (CANCEL) or item 6 (RESUME).  
BITE. The hexadecimal representation of the BITE registers is displayed if the sequence stops for an error condition.  
TIME. The time of the error stop in hr:min:sec is displayed.
- (5) STOP. Item 3 causes execution to stop at the end of the current step.
- (6) STOP AT. ITEM 4 +X X X X X EXEC causes execution to stop at step XXXXX (main sequence only).
- (7) CANCEL. Item 5 terminates the sequence and clears it from the display and the buffer.

TCS CONTROL (Cont):

- (8)** RESUME. Item 6 resumes a suspended sequence with the next step (at the step number shown at STEP, if the stop is within the main sequence).
- (9)** RSM AT. ITEM 7 +X X X X ENTER resumes a suspended sequence with the main sequence step numbered XXXXX.
- (10)** CLEAR MSGS. Item 8 clears out all the text messages on the display together with their associated time tags.
- (11)** TEXT. Execution of a text operator within the sequence (with CRT as the designation) causes the text to be displayed. A maximum of 34 characters is allowed. Latest message is on top; others roll down to make room; 15 maximum; any excess message drops off the bottom.  
  
TIME. The Greenwich Mean Time (GMT), in hr:min:sec, associated with each message is displayed.
- (12)** ECP ERROR. The decimal equivalent of the ECP error code will be displayed when a call program error is encountered. The error code is blanked upon the start of a new ECP.

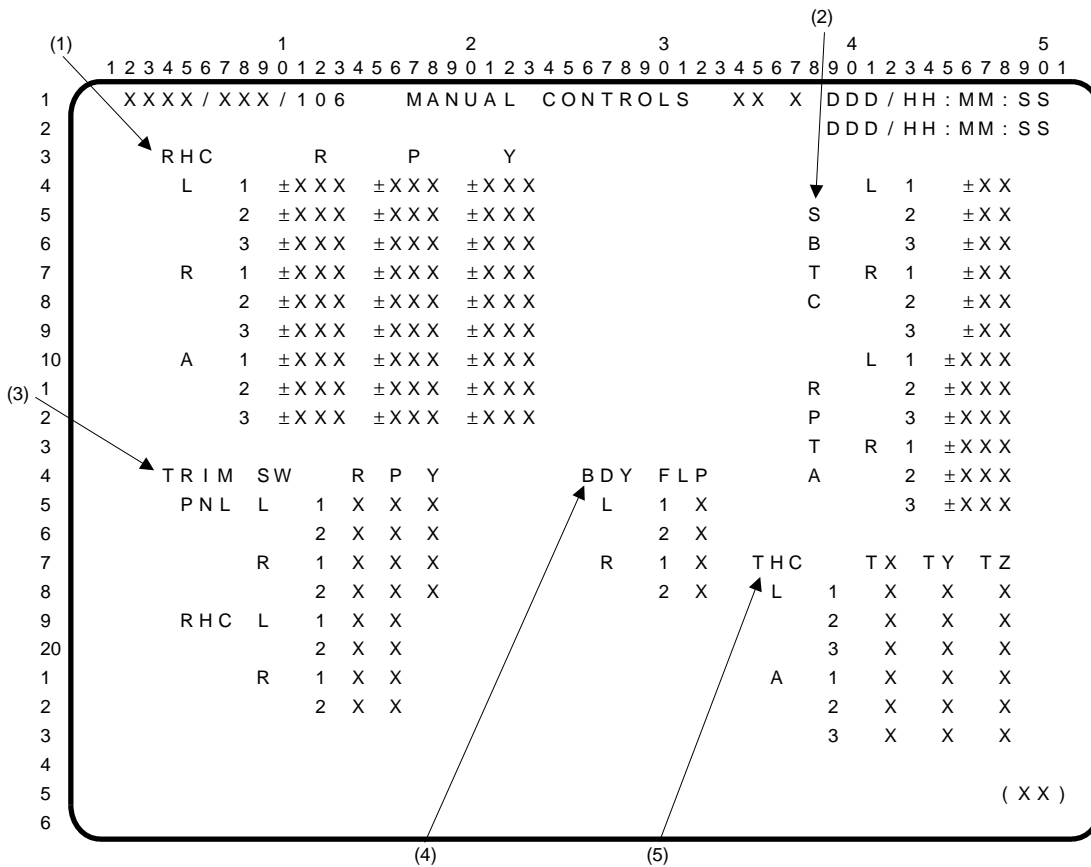

MANUAL CONTROLS is a display (DISP 106) which is available in GNC OPS 9. This display is used to test the switch contacts and transducers associated with the trim switches, body-flap switches, rotational hand controllers (RHC), translational hand controllers (THC), speedbrake thrust controller (SBTC), and rudder pedal transducer assembly (RPTA). These controllers are disengaged from their normal functions when this display is active.

- (1) ROTATIONAL HAND CONTROLLERS. Roll (R), pitch (P), and yaw (Y) axes displayed in percent deflection. Three channels each for left-hand, right-hand, and aft stations.
- (2) SPEED BRAKE THRUST CONTROLLER and RUDDER PEDAL TRANSUDCER ASSEMBLY. Three channels each for left-hand and right-hand stations displayed in percent deflection.
- (3) TRIM SWITCHES. R, P, and Y axes. Two channels each for left-hand and right-hand panel switches for left-hand and right-hand RHC switches. (No RHC yaw trim switches.)
- (4) BDY FLP. Two channels each for left and right stations.
- (5)\* TRANSLATIONAL HAND CONTROLLERS. X, Y, and Z axes. Three channels each for forward and aft stations.

\*PROGRAM NOTES

- (5) AFT THC Data Display. The physical orientation (rotated 90 degrees clockwise) of the AFT THC causes crew commands to be displayed as follows:

THC CMD	TX	TY	TZ
PUSH	+		
PULL	-		
DOWN		+	
UP		-	
STBD			+
PORT			-

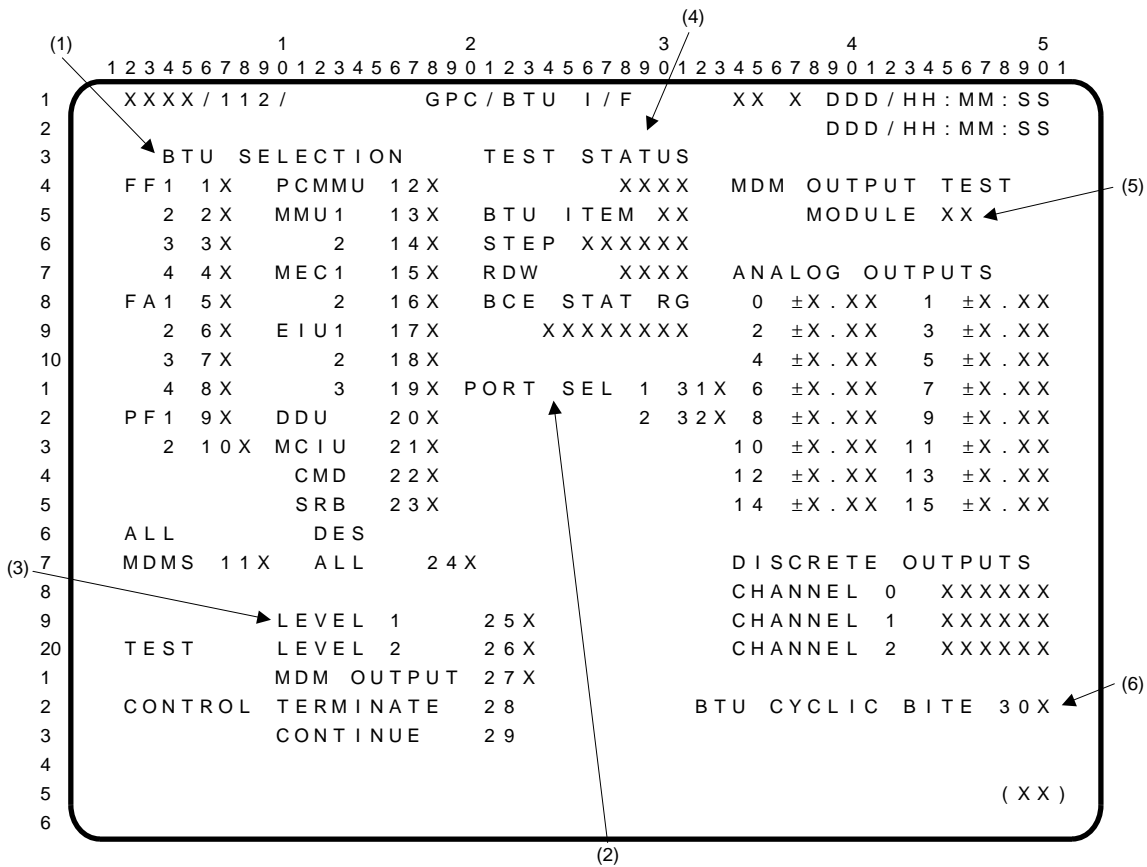

The GPC/BTU I/F display is a GNC specialist function (SPEC 112) available in GNC OPS 9. This display provides control and monitoring of GPC/BTU interface testing during ground checkout. All tests are executable in a redundant GPC configuration except the PCMMU (item 12) which is limited to a simplex GPC configuration.

- (1)\* BTU SELECTION. Items 1 thru 10 select a Multiplexer/Demultiplexer (MDM) for testing. More than one of these may be selected at one time. Item 11 selects all ten of the above MDMs for testing. Items 12 thru 23 select a non-MDM Bus Terminal Unit (BTU) for testing. If one of these is selected, no other BTU may be selected at the same time. An '\*' is displayed next to the selected item(s), 1 thru 23. Item 24 deselects all BTUs. Deselection is indicated by an '\*' displayed next to item 24. Items 1 thru 10 are mutually exclusive with items 11 thru 24 and items 11 thru 24 are mutually exclusive with each other. An attempt to select items 11 thru 24 while any test is in progress or suspended will be rejected and results in an error message.
- (2) PORT SEL. Items 31 and 32 are used to select MDM ports for testing. This selection has no effect on MDM ports used for other traffic. An '\*' beside the appropriate item indicates the selected port.
- (3)\* LEVEL. Item 25 initiates level one (interface verification) testing which is applicable to all selectable BTUs. The item number of the BTU being tested is displayed next to 'BTU ITEM'. An '\*' is displayed next to the selected item, and 'ACT' is displayed under 'TEST STATUS'. Item 26 initiates level two (internal operations) testing on the selected MDM, PCMMU, MCIU, EIU, MEC, CMD, and SRB BTUs.

NOTE: Execution of item 26 when an IMU has been commanded to operate will generate an 'ILLEGAL ENTRY' message and exit the test.

Item 27 initiates MDM output testing which is applicable to all selectable MDMs. Item 28 terminates testing in progress, or suspends it in an orderly manner. Item 29 continues a suspended test or causes the MDM output test to go on to the next step.

NOTE: Execution of item 25, 26, or 27 while in the redundant set shall result in an 'ILLEGAL ENTRY' message.

GPC/BTU I/F (Cont):

- (4) TEST STATUS. Blank until a test is initiated or after BTU selection is reconfigured but before another test is initiated; 'ACT' (Active) when a test is running or suspended because of an error; 'CPLT' (Complete) after the test is completed or terminated.

BTU ITEM. The item number corresponding to the BTU being tested for items 1 thru 21. For item 22 (CMD), a 31, 32, or 37 is displayed, corresponding to command decoder MDMs LF01, LA01, or LM01, respectively. For item 23 (SRB), a 33, 34, 35, or 36 is displayed corresponding to SRB MDMs LL01, LL02, LR01, and LR02, respectively.

STEP. The number (decimal) of the current step in the current test.

RDW. The value of the Response Data Word (RDW) (in hexadecimal) in error if the test is suspended for a miscompare.

BCE STAT RG. The value in the Bus Control Element (BCE) status register (hexadecimal) when the test is suspended for a miscompare. Four hexadecimal digits represent each 16-bit half of the register.

- (5) MODULE. The number (decimal) of the module within the MDM (BTU item number) being output tested.

ANALOG OUTPUTS. The outputs (decimal) of the test module if it is analog; blank otherwise.

DISCRETE OUTPUTS. The outputs (hexadecimal) of the tested module if it is a discrete module; blank otherwise.

- (6) Execution of item 30 initiates BTU cyclic Built-In Test Equipment (BITE) processing. An '\*' is displayed next to item 30 when the processing is active. Cyclic BITE processing continues until item 30 is executed again or an Operational Sequence (OPS) transition occurs, at which time processing stops and the '\*' is blanked. The display is initialized with cyclic BITE processing disabled.

\*PROGRAM NOTES

- (1) (3) Run MCIU Level 2 Test before Level 1. The level 2 MCIU test will fail if run after level 1 because of the 'F0F0' pattern set by the level 1 test. Also, with no arm selected on the D&C panel and MCIU power in primary, the BTU readiness test will generate an 'S' bit I/O error on the first transaction after MCIU power on. Initiation of the level 2 test for the first time should be terminated (item 28) after the I/O error and reinitiated a second time. Initiation of level 1 testing should then cause the display to depict the bit settings resulting from level 2 and level 1 testing. (DR 41008)

	(1)										(2)										(3)										(4)										(5)									
	1	2	3	4	5	6	7	8	9	0	1	2	3	4	5	6	7	8	9	0	1	2	3	4	5	6	7	8	9	0	1	2	3	4	5	6	7	8	9	0	1	2	3	4	5	6	7	8	9	0
1	XXXX / 113 /										ACTUATOR CONTROL										XX X DDD / HH : MM : SS																													
2	MONITOR										FAIL										DDD / HH : MM : SS																													
3	CMD		POS		ACT		A		B		C		D		ACTUATOR GIMBALING																																			
4	±XX.XX		±XX.XX		SB		1X		S		S		S		RATE		29		XX.XX		DEG / SEC																													
5	±XX.XX		±XX.XX		RUD		2X		S		S		S		FIN		POS		30		[±]X.X.XX		DEG																											
6	±XX.XX		±XX.XX		LIE		3X		S		S		S		START		31		XXX		STOP		32		X																									
7	±XX.XX		±XX.XX		RIE		4X		S		S		S		STATUS										XXXX																									
8	±XX.XX		±XX.XX		LOE		5X		S		S		S		HYD PR		ECP		ERR		XXX																													
9	±XX.XX		±XX.XX		ROE		6X		S		S		S		1		XXXX		BF		MON		33		X																									
10	±XX.XX		±XX.XX		1P		7X		S		S		S		2		XXXX																																	
1	±XX.XX		±XX.XX		1Y		8X		S		S		S		3		XXXX																																	
2	±XX.XX		±XX.XX		2P		9X		S		S		S		AI										SRB / NW		34		X																					
3	±XX.XX		±XX.XX		2Y		10X		S		S		S		ME		ISO V																																	
4	±XX.XX		±XX.XX		3P		11X		S		S		S		1X		2X 3X		FC										LIM		CHNG																			
5	±XX.XX		±XX.XX		3Y		12X		S		S		S		R / SB										MAT		35		X																					
6	±XX.XX		±XX.XX		RPA		13X												R / SB		RFG / FRT		36		X																									
7	±XX.XX		±XX.XX		RPS		14X		AI										MODES		MAT		P		40		MS		37		X																			
8	±XX.XX		±XX.XX		RYA		15X		0		SAFE		22		X		NOP		CA		RFG		38		X																									
9	±XX.XX		±XX.XX		RYS		16X		1		MDM		23		X		NOP		CA		FRT		39		X																									
20	±XX.XX		±XX.XX		LPA		17X		2		FERY		24		X		NOP		OMS		40		X																											
1	±XX.XX		±XX.XX		LPS		18X		3		RAIN		25		X		SRB		S / S		LIM		41		X																									
2	±XX.XX		±XX.XX		LYA		19X		4		GRAV		26		X		EL		POS		LIM		42		X																									
3	±XX.XX		±XX.XX		LYS		20X		5		NULL		27		X		S / B		POS		LIM		43		X																									
4	XX		±XX.XX		BF		21		X		6		TURN		28		X		R		RATE		.5		PCM		44		X																					
5																																																		
6																																																		

ACTUATOR CONTROL is a specialist function (SPEC 113) available in GNC OPS 9. It provides control and monitoring of the positioning of aero surfaces, SSME, OMS, and body flap actuators using the ramp function generator (RFG) and body flap drive (BFD) functions. It also supports the initiation of all actuator initialization (AI) modes and the body flap monitor (BFM) function; the inhibiting of collision avoidance and interference checks and the OMS power discrete parameter output; the replacement of position limit values for SRB, elevon, and speedbrake actuators; the limiting of the multiple actuator test (MAT) plateau segment duration and modification of the RFG rate limit.

- (1) Items 1 thru 6 provide individual aerosurface actuator selection (indicated by an “\*”) as follows:
- |                                   |                                     |
|-----------------------------------|-------------------------------------|
| Item 1: Speedbrake (SB)           | Item 4: Right inboard elevon (RIE)  |
| Item 2: Rudder (RUD)              | Item 5: Left outboard elevon (LOE)  |
| Item 3: Left inboard elevon (LIE) | Item 6: Right outboard elevon (ROE) |

Items 7 thru 12 provide individual Space Shuttle Main Engine (SSME) actuator selection (indicated by an “\*”) as follows:

- |                           |                            |
|---------------------------|----------------------------|
| Item 7: SSME 1 pitch (1P) | Item 10: SSME 2 yaw (2Y)   |
| Item 8: SSME 1 yaw (1Y)   | Item 11: SSME 3 pitch (3P) |
| Item 9: SSME 2 pitch (2P) | Item 12: SSME 3 yaw (3Y)   |

Items 13 thru 20 provide individual Orbital Maneuvering Subsystem (OMS) actuator selection (indicated by an “\*”) as follows:

- |  |                                       |
|--|---------------------------------------|
| Item 13: Right OMS pitch active (RPA)  | Item 17: Left OMS pitch active (LPA)  |
| Item 14: Right OMS pitch standby (RPS) | Item 18: Left OMS pitch standby (LPS) |
| Item 15: Right OMS yaw active (RYA)    | Item 19: Left OMS yaw active (LYA)    |
| Item 16: Right OMS yaw standby (RYS)   | Item 20: Left OMS yaw standby (LYS)   |

Item 21 allows selection of the body flap (BF) actuators (all three actuators are used). Items 1 thru 21 are initialized deselected.

- (2) MONITOR. The commanded and actual positions for each actuator (except body flap) are displayed in degrees to the left of the actuator item select. The position values actively reflect current values all the time while the command values (except for body flap) show current values only after an AI Mode 1 has been executed in G9. The command position for body flap will indicate the direction of the commanded deflection; i.e., UP, DN, or blank (no drive).

## ACTUATOR CONTROL (Cont):

(3) FAIL. The status of the feedback I/O channels for the aerosurface and SSME actuators is displayed to the right of the actuator item select. A down arrow '↓' is displayed for hardware channel failure, an 'M' for commfault (missing data), and blank for normal operations.

(4) AI MODES. Items 22 thru 28 are used to select and start (indicated by an '\*') an actuator initialization mode function as follows:

- Item 22: AI MODE zero (0 SAFE) initial position for all actuators, except SRB and nosewheel.
- Item 23: AI MODE one (1 MDM) MDM preconditioning option for all actuators except SRB and nosewheel.
- Item 24: AI MODE two (2 FERY) ferry positions for all applicable actuators.
- Item 25: AI MODE three (3 RAIN) rain positions for all applicable actuators.
- Item 26: AI MODE four (4 GRAV) gravity positions for all applicable actuators.
- Item 27: AI MODE five (5 NULL) null positions for all applicable actuators.
- Item 28: AI MODE six (6 TURN) turn around positions for all applicable actuators.

NOTE: Items 1 thru 28 are mutually exclusive. Execution of any of items 22 thru 28 will blank the actuator direction of movement display and deselect any previously selected actuator or AI mode, and blank item 31 (START) status indicator (\*).

(5)\* ACTUATOR GIMBALING. Items 29 thru 34 are used to control and monitor actuator gimbaling. The rate of movement (RATE) in degrees per second and the final position (FIN POS) of each actuator can be specified using items 29 and 30, respectively. Rate input range is from +00.00 to +99.99, and final position input range is from -99.99 to +99.99. Entry of item 29 or 30 without an actuator selected for positioning will result in an 'ILLEGAL ENTRY' message. Item 31 (START) is used to initiate positioning of the selected actuator. An '\*' is displayed upon execution; the selected actuator's direction of movement is also displayed to the right of the asterisk once an actuator and a final position have been selected. The direction of the arrow (up, down, left, or right pointing) will reflect movement when viewing the orbiter from the rear. The speedbrake uses a combination of arrows indicating opening (← →) or closing (→ ←). Execution of item 32 (STOP) halts the movement of the selected actuator or selected AI mode and drives an '\*' beside item 32. If item 31 was the last item selected, the selected actuator will stop moving and the '\*' after item 31 will be blanked. Item 31 cannot be executed again until reexecution of item 32, which blanks the '\*' next to item 32, and blanks the RATE and FIN POS data fields. If an AI mode (items 22 thru 28) was the last item selected, execution of the selected AI mode will cease. Execution of items 22 thru 28 is inhibited until item 32 is reexecuted, which removes the '\*' next to the selected AI mode and item 32.

For actuator movement or AI mode, the STATUS field will display RUN (in progress or executing), CPLT (complete, terminates normally), STOP (terminates abnormally), or BUSY (request rejected because a non-SPEC initiated ECP is active). Any error encountered by the TCS calling program during actuator movement, AI mode execution, or by the body flap monitor is displayed next to ECP ERR. This field is blanked upon execution of any of items 22 thru 28 (AI MODES), item 31 (START), or item 33 (BF MON). Item 33 (BF MON) is used to alternately select/deselect the body flap monitor function, depending on the previous state. An '\*' indicates selection. Item 34 (AI SRB/NW) is used to enable commanding of the SRB and nosewheel actuator MDMs in AI modes zero (0 SAFE) and one (1 MDM). An '\*' indicates selection.

(6) HYD PR. The hydraulic supply pressure A for orbiter systems 1, 2, and 3 is displayed in psia.

(7) ME ISO V. The position of the main engine/thrust vector control isolation valves for orbiter hydraulic systems 1, 2, and 3 is displayed. A 'C' displayed after a number indicates the valve is closed; blank indicates the valve is open.

(8) FC LIM CHNG. Items 35 thru 44 are used to alternately select/deselect certain check functions and limit value replacements. An '\*' beside the item number indicates its selection. Item 35 (R/SB MAT) is used to bypass the rudder/speedbrake interference check in the MAT function. Item 36 (R/SB RFG/FRT) is used to bypass the rudder/speedbrake interference check in the RFG and Frequency Response Test (FRT) functions. Item 37 (MAT P40 MS) is used to set the MAT plateau duration at 40 milliseconds. Item 38 (NOP CA RFG) is used to bypass the collision avoidance and SSME 1/OMS pods clearance checks in the RFG function. Item 39 (NOP CA FRT) is used to bypass the collision avoidance check in the FRT function.

## ACTUATOR CONTROL (Cont):

Item 40 (NOP OMS) is used to inhibit output of the OMS power discretes by the actuator ECP functions and inhibit the resultant out-of-tolerance error codes from the AI functions for OMS actuators. Item 40 is initialized to the inhibit state (\*) during the OPS G9 initialization process. Item 41 (SRB S/S LIM) is used to cause the SRB software stop limits to replace the high and low position limits for the SRB actuators. Item 42 (EL POS LIM) is used to replace the elevon high position limits. Item 43 (S/B POS LIM) is used to replace the speedbrake low position limit. Item 44 (R RATE .5 PCM) is used to set the RFG function rate limit at 0.5 PCM counts. Execution of items 35 thru 44 is illegal if any ECP, except BFM, is active.

## \*PROGRAM NOTES

- (5) 'ILLEGAL ENTRY' Error Conditions. Execution of item 31 (START) without an actuator selected (items 1 thru 21), rate entered (item 29, except for OMS and body flap), and final position entered (item 30) is illegal. Execution of item 32 (STOP) without an active process is illegal. All item entries except 32 (STOP) and 33 (BF MON) are illegal when non-AI SPEC initiated actuator positioning is in progress.



SYSTEMS MANAGEMENT CRT DISPLAYS

	<u>PAGE</u>
OPS 2011 ANTENNA.....	4-2
OPS 2021 PL BAY DOORS .....	4-5
SPEC 60 SM TABLE MAINT .....	4-7
SPEC 62 PCMMU/PL COMM .....	4-9
SPEC 64 SM GROUND CHECKOUT .....	4-12
DISP 66 ENVIRONMENT .....	4-14
DISP 67 ELECTRIC .....	4-16
DISP 68 CRYO SYSTEM.....	4-17
DISP 69 FUEL CELLS .....	4-18
DISP 76 COMMUNICATIONS .....	4-19
DISP 77 EVA-MMU/FSS.....	4-21
DISP 78 SM SYS SUMM 1 .....	4-22
DISP 79 SM SYS SUMM 2 .....	4-24
SPEC 85 MASS MEMORY R/W .....	4-26
DISP 86 APU/HYD .....	4-28
DISP 87 HYD THERMAL .....	4-30
DISP 88 APU/ENVIRON THERM .....	4-31
DISP 89 PRPLT THERMAL .....	4-33
SPEC 90 PCS CONTROL.....	4-34
SPEC 94 PDRS CONTROL.....	4-37
DISP 95 PDRS OVERRIDE .....	4-41
DISP 96 PDRS FAULTS.....	4-43
DISP 97 PL RETENTION.....	4-45
DISP 167 DOCKING STATUS.....	4-46
DISP 168 CARGO LOOP.....	4-48
DISP 169 PDRS STATUS.....	4-50
DISP 177 EXTERNAL AIRLOCK.....	4-52
DISP 179 POWER TRANSFER.....	4-54
<u>PAYLOAD (PL) CRT DISPLAYS .....</u>	4-55
SPEC 111 SL MEMORY DUMP.....	4-56
OPS 9011 MASS MEMORY R/W .....	(SEE SM, PAGE 4-26)
SPEC 100 GTS DISPLAY .....	(SEE GNC, OPS G9, PAGE 3-92)

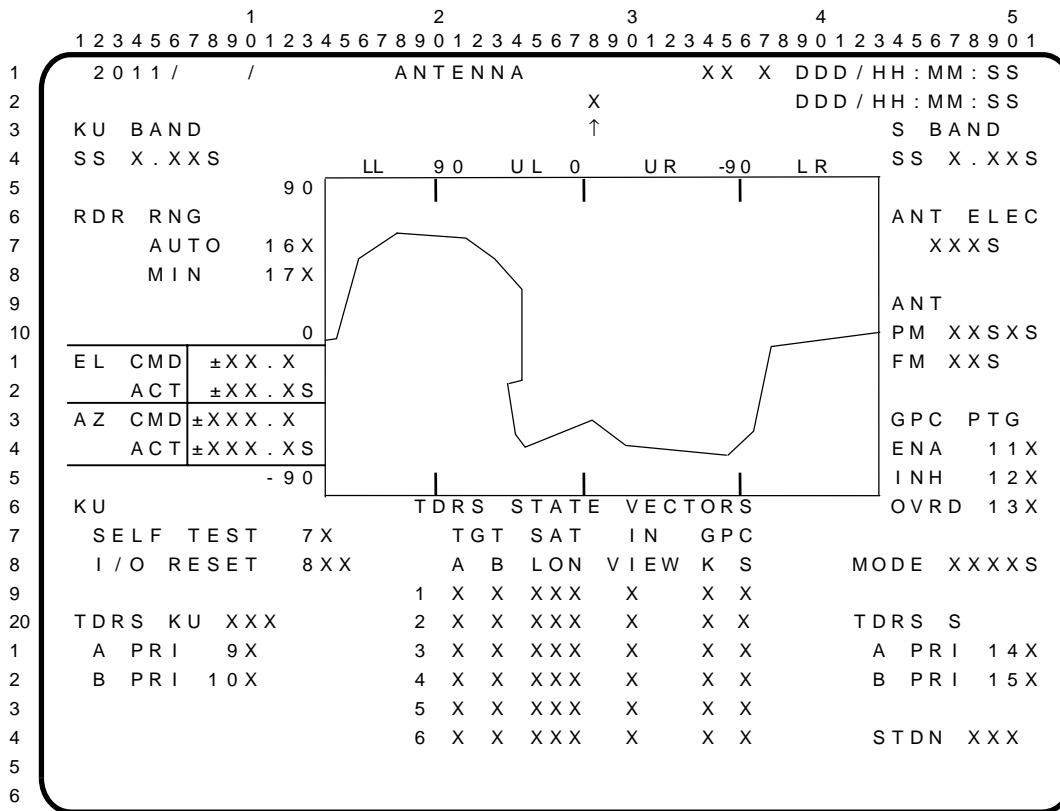

The ANTENNA display is an operations sequence (OPS X011) available in SM OPS 2 and 4 which allows control of GPC sequences for the S-band and Ku-band antenna systems.

### PARAMETER CHARACTERISTICS

CRT NAME	UNITS	DISPLAYED RANGE	STATUS INDICATORS				
			M	H	L	↑	↓
KU BAND: SS [1]	volts	0 to 5	M				
ANT EL CMD	deg	-99.9 to +99.9					
ACT	deg	-99.9 to +99.9	M				
AZ CMD	deg	-999.9 to +999.9					
ACT	deg	-999.9 to +999.9	M				
TDRS Ku [2]	text	'TGT' or blank					
S BAND: SS [1]	volts	0 to +5	M				
ANT ELEC	text	1,2, 'OFF', blank	M				
PM [3] [4]	text	See Remarks	M				↓
FM [4]	text	'UP' or 'LO'	M				↓
MODE [5]	text	See Remarks	M				
STDN [6]	text	See Remarks					
TDRS STATE VECTORS							
SAT LON 1	deg	0 to 360					
2	deg	0 to 360					
3	deg	0 to 360					
4	deg	0 to 360					
5	deg	0 to 360					
6	deg	0 to 360					
Pictorial Section [7]	text	See Remarks					

### REMARKS

- [1] Parameters are a measure of received signal strength.
- [2] 'TGT' denotes the Ku-band system is tracking a GNC target.
- [3] First data field denotes selection of upper right (UR), upper left (UL), lower right (LR), or lower left (LL) S-band PM Quad antenna. Second data field denotes selected Switch Beam position – forward (F) or aft (A).

SM

## ANTENNA (Cont):

**[4]** '↓' denotes a mismatch between GPC commanded and actual antenna selected.

**[5]** Mode displayed is TDRS, S-LO (low power), S-HI (STDN high power), and SGLS.

**[6]** A three-character designation of STDN/SGLS site used in automatic antenna pointing

CAN – Canberra (Australia)	CTS – Colorado Springs	DFR – Dryden
DGS – Diego Garcia	GDX – Goldstone	GTS – Guam
HTS – Kaena Point (Hawaii)	JSC – Johnson Space Cen.	MAD – Madrid (Spain)
MIL – Merritt Island	NHS – New Hampshire	OTS – Oakhanger (England)
VTS – Vandenberg	WLP – Wallops	

Note: SGLS site location identifiers end with an 'S'.

**[7]** Look angles to target (TDRS, STDN, etc) relative to orbiter coordinates. TDRS denoted by 'A', 'B', 1, 2, 3, 4, 5, 6; STDN/SGLS site by 'S'. Orbiter's -Z axis at 0.0 on plot; +X axis at 90.0 on plot. For Ku-band system only, background lines denote line-of-sight blockage by the orbiter. Actual Ku-band antenna position denoted by a □.

## ITEM ENTRY CHARACTERISTICS

ITEMS 1 through 6 TDRS TGT SELECT A or B – used to assign any of the 6 TDRS state vectors, to targets A or B. An '\*' is displayed in the 'A' column adjacent to the TDRS state vector slot number (1-6) if that TDRS state vector slot is selected as the 'A' target. An '\*' is displayed in the 'B' column adjacent to the TDRS state vector slot number (1-6) if that TDRS state vector slot is selected as the 'B' target. Only one TDRS state vector slot can be assigned to target 'A' or 'B' at a time. The same TDRS state vector slot can be assigned to both 'A' and 'B'.

ITEMS 16 and 17 RDR RNG – used to control the range estimate output (AUTO or MIN) to the Ku-band Rendezvous Radar/COMM A system. An '\*' is displayed next to the selected item. Initialization is in AUTO.

ITEM 7 SELF-TEST – used to select or terminate the radar self-test function. An '\*' appears next to item 7 when the self-test is selected. After the 3-minute test is completed, item 7 must be reexecuted to deselect the self-test function and blank the test results (displayed on the Range meter on panel A2).

ITEM 8 I/O RESET KU – used to initiate communication between SM GPC and the Ku-band system. An '\*' is displayed next to the item whenever the interface is enabled, otherwise an 'M' is displayed. When the SM is initialized, the interface is enabled.

ITEMS 9 and 10 TDRS KU PRI A/B – item 9 allows the SM Antenna Management (AM) software to select TDRS target 'A' for primary pointing of the Ku-band Comm antenna, if it is in view. If target 'A' is not in view but target 'B' is in view, the target 'B' TDRS satellite will be utilized for pointing. If neither target 'A' nor 'B' is in view, the lowest numbered TDRS state vector slot in view will be utilized for pointing (as denoted by the '\*' located in the 'IN VIEW' column of the TDRS STATE VECTORS table). Item 10 allows AM to select TDRS target 'B' for primary pointing if it is in view. If target 'B' is not in view but target 'A' is in view, the target 'A' TDRS satellite will be utilized for pointing. If neither is in view the lowest numbered slot in view will be used for pointing. An '\*' is displayed next to the selected item entry. Initialization is in TDRS Ku A PRI.

ITEMS 11 and 12 GPC ANT CMD ENA/INH – used to enable or inhibit AM selection of S-band antennas. An '\*' is displayed next to the selected function. ENA is selected at SM initialization.

ITEMS 13 OVRD – used to force AM to TDRS mode and remain there. This will allow AM to select the best S-Band antenna to TDRS even if there is a status problem preventing AM from knowing what is the correct mode. An '\*' is displayed next to the item when it is enabled. The display is initialized with item 13 inhibited.

ANTENNA (Cont):

ITEM 14 and 15      TDRS S-Band PRI A/B – works the same as the Ku-band PRI A/B function but for the S-Band antennas.

PROGRAM NOTE

S-Band Antenna Selection. When using the Antenna S-Band PM rotary switch (panel C3), allow at least 2 seconds at each intermediate position.

```

1 2 3 4 5 6 7 8 9 0 1 2 3 4 5 6 7 8 9 0 1 2 3 4 5 6 7 8 9 0 1 2 3 4 5 6 7 8 9 0 1
1 X021/063/ PL BAY DOORS XX X DDD/HH:MM:SS
2 BFS DDD/HH:MM:SS
3 AC POWER ON 1X
4 OFF 2X PBD SW-XXXXX
5 AUTO MODE SEL 3X MICRO-SW STAT
6 LATS DOORS
7 MAN OP/CL AUTO CCOO CRRRO
8 CENTER LATCHES SEL SEQ ABAB ABC
9 5-8 4X XXS X XXXX
10 9-12 5X XXS X XXXX
1 1-4 6X XXS X XXXX
2 13-16 7X XXS X XXXX
3 STBD
4 FWD LATCHES 8X XXS X XXXX XXXXX
5 AFT LATCHES 9X XXS X XXXX XXXXX
6 DOOR 10X XXXS X
7 PORT
8 FWD LATCHES 11X XXS X XXXX XXXXX
9 AFT LATCHES 12X XXS X XXXX XXXXX
20 DOOR 13X XXXS X
1 OPEN 15X
2 PBD SW BYPASS 14X STOP 16X
3 CLOSE 17X
4
5 (XX)
6

```

Note:  indicates parameters are driven and displayed on the BFS displays only.

The PL BAY DOORS display is an SM operational sequence (OPS 202) available in SM OPS 2 and BFS OPS 0 as SPEC 63, which allows the crew to monitor and control payload bay doors and associated latches opening/closing. Termination of this OPS mode or SPEC (in BFS) with panel R13 switch or item 16 not in the STOP mode will result in an 'ILLEGAL ENTRY' message.

### PARAMETER CHARACTERISTICS

CRT NAME	UNITS	DISPLAYED RANGE	STATUS INDICATORS					
			M	H	L	↑	↓	?
PBD SW [1]	text	See Remarks	M					
OP/CL: LATCHES [2] [3] (8 Parameters)	text	See Remarks	M					?
DOOR [2] [4] (2 Parameters)	text	See Remarks	M					?
AUTO SEQ [5]	text	blank or '↓'						
MICRO-SW STAT [6]	text	0 or 1						

### REMARKS

- [1] Text reflects position of lever-lock switch on R13 as 'OP', 'STOP', or 'CL', and 'FAIL' for switch contact failures.
- [2] 'OP' indications proceed top-to-bottom in open auto-sequence; 'CL' goes bottom-to-top in close auto-sequence.
- [3] In a transition period, the field is blank. For a 100 percent successful sensing, 'OP' or 'CL' is displayed. For dilemmas, '?' is displayed.
- [4] In a transition period, the field is blank. For a 100 percent successful sensing on both STBD and PORT doors, 'OP' or 'CL' is displayed. For dilemmas, '?' is displayed. For each door if both FWD and AFT have two of three microswitches indicating ready-to-latch, 'RDY' is displayed.
- [5] '↓' denotes a door or latch failed to reach commanded position in required time; the sequence stops at this point. AUTO sequence only.

## PL BAY DOORS (Cont):

- [6]** A '1' denotes a positive condition (e.g., closed, open, ready). A '0' denotes an indeterminate condition (e.g., not-closed, not-open, not-ready).

### ITEM ENTRY CHARACTERISTICS

- ITEMS 1 and 2 AC POWER ON/OFF – mutually exclusive, apply/remove AC power to/from motor control assemblies. '\*' indicates current status.
- NOTE: The AUTO sequence includes an 'out-of-sequence' configuration check. If an improper configuration is sensed, the AUTO sequence will automatically remove AC power from the MCAs, mode the '\*' to OFF (item 2), and issue a class 3 alert.
- ITEM 3 AUTO MODE SEL – enable/disable automatic sequencing of the doors. Enable is an illegal entry unless doors are in stop mode (by either panel R13 switch or item 16).
- ITEMS 4 thru 13 MAN SEL – enable manual door operations. Enable is an illegal entry if automatic mode is selected (item 3) and doors are not in stop mode (by either panel R13 switch or item 16). If manual operations are in progress, additional items can be enabled when doors are not in stop mode. However, disabling entries while in this config is an illegal entry.
- ITEM 14 PBD SW BYPASS – used to bypass/enable the switch on panel R13. When bypass is initiated, items 15, 16, and 17 become operative with item 16 (STOP) selected.
- ITEMS 15, 16, and 17 OPEN/STOP/CLOSE – mutually exclusive, used to control door opening, closing, or to stop the doors. Illegal entries unless item 14 is in bypass mode.

### PROGRAM NOTES

Payload Bay Door Talkback. When the BFS is taken to RUN, the Payload Bay Door position indicator on panel R13 is initialized to barberpole, regardless of the true state of the doors. To show the true state, call BFS SM SPEC 63. (B08246)

BFS Payload Bay Door Operation. PLBD operations cause unique handling of SPECS and displays in BFS. The BFS operates as follows:

1. RESUME, MF switch, display, and SPEC requests operate per the normal interaction of structures requirements when a PLBD OPEN or CLOSE sequence is not in progress.
2. RESUME, MF switch, display, and SPEC requests operate per normal interaction of structures requirements as long as there is more than one CRT with the PLBD SPEC active.
3. If only one CRT has the PLBD SPEC active, RESUME of PLBD SPEC is illegal if either:
  - a. PBD SW BYPASS (item 14) is not selected and the PL BAY DR switch is not in the STOP position, or
  - b. PBD SW BYPASS (item 14) is selected and the STOP item (item 16) is not selected.
4. A change of MF is allowed while a PLBD OPEN or CLOSE sequence is in progress and the sequence will continue.
5. PLBD OPEN or CLOSE sequence will continue if a SPEC or display is called on top of the PLBD SPEC.
6. A SPEC may overlay the PLBD SPEC, but if an OPEN or CLOSE sequence is in progress and that CRT is the only CRT with the PLBD SPEC active, RESUME will return to the PLBD SPEC. (B03926)

BFS PL Bay Door Manual Item Entries May Cause Problem in Auto Mode. PBD auto sequence may operate out of order if it is preceded by the execution of a manual item entry that is out of the normal sequence order. If the auto sequence operates out of order, perform the following steps:

- a. Stop auto sequence
- b. Correct the out-of-order condition using manual mode.
- c. Reset sequence to proper latch/door group by manual item entry.
- d. Continue sequence in either auto or manual. (B28716)

This Page Intentionally Blank



```

1 2 3 4 5 6 7 8 9 0 1 2 3 4 5 6 7 8 9 0 1 2 3 4 5 6 7 8 9 0 1 2 3 4 5 6 7 8 9 0 1
1 XXXX/060/ SM TABLE MAINT XX X DDD/HH:MM:SS
2 SM COM BUFF XXX DDD/HH:MM:SS
3 PARAM XXXXXX
4 1 ID XXXXXX
5 VALUE= [ ]XXXXXXXXXS
6
7 LIMITS
8 ALERT | BACKUP C&W
9 LOW HI | LOW HI
10 2X [ ]XXXXXXXX 3 [ ]XXXXX.XX 11X [ ]XXXXXXXXXX 12 [ ]XXXXXXXXXX
11 4X [ ]XXXXXXXX 5 [ ]XXXXX.XX
12 6X [ ]XXXXXXXX 7 [ ]XXXXX.XX
13 8 FILTER XX 13 FILTER XX
14 ENA 9X ENA 14X
15 INH 10X INH 15X
16
17 CONSTANT
18 16 ID XXXXXX
19 17 VALUE= [ ]XXXXXXXXXXXXXXXXXX
20
21 CHECKPT XXX/XX:XX:XX FDA
22 INITIATE 18 ENA 19X
23 STATUS XXXX INH 20X
24
25 (XX)

```

The SM TABLE MAINT display is an SM specialist function (SPEC 60) available in SM OPS 2 and 4 which allows control of the SM software.

**PARAMETER CHARACTERISTICS**

CRT NAME	UNITS	DISPLAYED RANGE	STATUS INDICATORS					
			M	H	L	↑	↓	
SM COM BUFF XXXXXX (uplink)	[1] [1]	text text	'RDY' or 'BSY' blank or 'UPLINK'					
PARAM VALUE CHECKPT XXX/XX:XX:XX	[2]	eng. units mission time	full range D/H:M:S	M	H	L	↑	

**REMARKS**

- [1] 'BSY' and 'UPLINK' displayed flashing. When flashing, keyboard entries will be rejected. 'BSY' denotes that another crewmember is using a function which addresses the SM Common Buffer. 'UPLINK' denotes that the ground is uplinking a Table Maintenance Block Update.
- [2] CHECKPT time is that of last valid checkpoint.

**ITEM ENTRY CHARACTERISTICS**

ITEM 1 PARAM ID – 7-digit, decimal entry. Upon successful entry, PARAM ID and VALUE fields are filled, as are applicable fields for LIMITS (items 2 thru 15). If PARAM ID is illegal, all associated data fields are blanked.

## SM TABLE MAINT (Cont):

Use the following table to convert function MSID to parameter ID; e.g., PO3K1027 = 6031027.

<u>1st Char of MSID</u>	<u>Numeric</u>	(First character of MSID must be converted to numeric. Fourth character of MSID is dropped.)
V	0	
A	1	
B	2	
E	3	
F	4	
G	5	
P	6	
T	7	
U	8	
L	9	
ITEMS 2 thru 7		LIMITS ALERT LOW/HI – used to change low and/or high FDA limits. The active limit set is denoted by an ‘*’ next to the ‘LOW’ limit. Multiple sets are applicable only to limits that are preconditioned. (See PROGRAM NOTES.)  Input of ±99999.99 as the LOW/HI limits will effectively disable the FDA for that parameter.
ITEM 8		LIMITS ALERT FILTER – used to change the number of consecutive out-of-limits samples required to get an FDA alert.
ITEMS 9 and 10		LIMITS ALERT ENA/INH – mutually exclusive; used to enable/inhibit the FDA alert. An ‘*’ denotes enable/inhibit status. The ‘↑’, ‘↓’, ‘H’, and ‘L’ indicators are retained with selection of item 10 (or item 15).
ITEMS 11 thru 15		BACKUP C&W – item entries similar to items 2 thru 10, except used for Backup C&W.
ITEM 16		CONSTANT ID – 7-digit, decimal entry. Upon successful entry, CONSTANT ID and VALUE fields are filled. If entry is illegal, both data fields are blanked.
ITEM 17		CONSTANT VALUE – used to change a calculation constant. Input of integer type constants that exceed the range of -32768 to +32767 will result in an ‘ILLEGAL ENTRY’ message.
ITEM 18		CHECKPT INITIATE – used to initiate an SM checkpoint of TM constants and FDA status (limit and filter values, inhibit/enable state). The CHECKPT STATUS field blanks upon initiation, and ultimately displays ‘GOOD’ or ‘FAIL’.
ITEMS 19 and 20		FDA ENA/INH – mutually exclusive; used to enable/inhibit <u>all</u> FDA alerts. An ‘*’ denotes status. The ‘H’, ‘L’ indicators are retained with selection of item 20.

## PROGRAM NOTES

SPEC/TMBU Interlock. Table Maintenance Block Update (TMBU) via uplink and SPEC 60 are interlocked such that TMBU loads are rejected if SPEC 60 is active, or if a TMBU is in progress and SPEC 60 is called, all items will be ‘ILLEGAL ENTRIES’. (DR 37572)

Limits for Discrete Parameters with Multiple Limit Sets. The out-of-limit state for a discrete parameter will be a +0, +1, or +2 entered in item 2. The +2 state causes FDA to be bypassed. If the +2 state is entered for a discrete parameter with only one limit set, an ‘ILLEGAL ENTRY’ message will result.

```

1 2 3 4 5 6 7 8 9 0 1 2 3 4 5 6 7 8 9 0 1 2 3 4 5 6 7 8 9 0 1 2 3 4 5 6 7 8 9 0 1
1 XXXX/062/ PCMMU/PL COMM XX X DDD/HH:MM:SS
2 SM COM BUFF XXX DDD/HH:MM:SS
3 PCMMU ORB C&W⇒ISS PDI
4 BITE WORD XXXX 20 XXX I/O RESET 8XX
5 FMT 21 TEST XXXX BITE WORD XXXX
6 SEL FXD 1XS 9 SEL DECOM X
7 PGM 2XS 10 SEL FMT XXX
8 PGM ID 64 XXX LOAD 11 XXXX
9 128 XXX 12 SEL INPUT X
10 3 SEL ID XXX LOAD 13
1 LOAD 4 XXXX DECOM INPUT FMT
2 1 X XXS
3 I/O RESET 2 X XXS
4 PCM 5XX 3 X XXS
5 4 X XXS
6 5-FPM XXX
7 PSP PL INTRG DECOM ENA ENA
8 I/O RESET 1 CHANNEL XXS FDA 1 14X 3 16X
9 PSP1 6XX 2 CHANNEL XXS 2 15X 4 17X
20 PSP2 7XX PHASE LOCK XXS 18 TFL GPC SEL X
1 SYNC BIT XXS ERR ±XXS DOWNLIST
2 FRAME XXS XMIT PWR XX.XXS 19 SEL FMT ID XX
3 LOAD XXXX XXXX PL SIG STR X.XXS
4
5 (XX)
6

```

The PCMMU/PL COMM display is an SM specialist function (SPEC 62), available in SM OPS 2 and 4 and GNC OPS 9, which allows control and monitoring of the Pulse-Code Modulation Master Unit (PCMMU), Payload Data Interleaver (PDI), Payload Signal Processor (PSP), Shuttle C&W transfer to ISS and displays Payload Interrogator (PL INTRG) parameters. If this SPEC is called during a TFL/DFL uplink, the request will be rejected and a class 5 error message will be generated.

**PARAMETER CHARACTERISTICS**

CRT NAME	UNITS	DISPLAYED RANGE	STATUS INDICATORS				
			M	H	L	↑	↓
SM COM BUFF [1]	text	'RDY' or 'BSY'					
PCMMU: BITE WORD [2] FMT SEL FXD, PGM PGM ID 64 128	hexadecimal text text text	hex blank or 'M' 1 to 127 128 to 254	M				
PDI: BITE WORD [3] SEL DECOM [4] FMT, DECOM 1-4 [5] 5-FPM [5] INPUT [6] DECOM INPUT FMT [7]	hexadecimal text text text text hexadecimal	hex 1 to 5 0 to 31 1 to 999 0 to 6 hex	M				↑
PSP: SYNC BIT FRAME LOAD [8]	text text text	yes, no, blank yes, no, blank See Remarks					
PL INTRG: CHANNEL [9] PHASE LOCK [9] ERR [9] XMIT PWR [9] PL SIG STR [9]	text text kHz watts volts	1, 2, blank yes, no, blank -85 to +85 0-16, blank 0-5, blank					
DOWNLIST: SEL FMT ID	text	24, 26					
ORB C&W ⇒ ISS [10] TEST [11]	text text	blank or ENA blank, 'RUN', 'CPLT', 'FAIL', 'RJCT'					

## PCMMU/PL COMM (Cont):

### REMARKS

- [1]** 'BSY' is displayed flashing to denote that the SM Common Buffer is in use. Keyboard entries will be rejected when 'BSY' is displayed.
- [2]** Nominal values are FFFC, FFFD, FFFE, or FFFF. A BITE anomaly will not announce a fault message. User must refer to a PCMMU BSR table or description to interpret these data.
- [3]** User must refer to MAL to interpret these data. When an I/O error has occurred on the BSR read element, an 'M' is displayed overbright.
- [4]** Entries 1 thru 4 are decommutator channels; entry 5 is Fetch Pointer Memory (FPM).
- [5]** Entries 0 thru 31 are legal with decommutator channels 1 thru 4 only, and entries 1 thru 999 are associated with FPM only.
- [6]** Entry 0 designates no input, entries 1 thru 5 select one to five payloads, and entry 6 designates operative PSP.
- [7]** This field displays the current payload inputs assigned to each decom and the last loaded format of the decoms and FPM. If SM is re-IPLed after loading, the format display will show all zeroes even though the PDI decoms are operating properly. If a decom fails and loaded format data are lost, '↑' is displayed next to the associated decom format (FMT) data field. If an I/O error occurs while reading the MM or PDI during the load process, loading will be terminated. Additionally, I/O or checksum errors incurred while reading the PDI will cause the last successfully loaded DFL or FPM format ID to be blanked on the display and set to zero.
- [8]** First status field displays 'RJCT' for rejection of a PSP command, 'INCP' for an incomplete command load, or blank for nominal PSP operations. Second status field uses double overbright text to identify which PSP command issuer is the source of the rejected/ incomplete load: 'TEC' (Time Executed Command), 'PCS' (Payload Control Supervisor), 'ITEM' (Cargo Control Spec Item Entry), 'U/L' (Uplink), 'GNC' (Guidance, Navigation & Control), 'MULT' (more than one source), or blank for nominal operation.
- [9]** This data field shows the last commanded CHANNEL selection, the PHASE LOCK and error (ERR) status, interrogator transmit power (XMIT PWR), and received payload signal strength (PL SIG STR) in SM OPS 2 and 4 only. These displays are blank for unpowered interrogators and in OPS G9.
- [10]** This field displays 'ENA' in SM OPS 2 and 4 only as long as the interface to the ISS is functional after the ITEM 20 EXEC; otherwise it is blank.
- [11]** This field is active for SM OPS 2 and 4 only. The status field displays 'RUN' for a test in progress, 'CPLT' for test passed, 'FAIL' for a failed Test, and 'RJCT' if the test is ignored.

### ITEM ENTRY CHARACTERISTICS

- ITEMS 1 and 2      FORMAT FXD/PGM – mutually exclusive, used to select either the fixed (FXD) or programmable (PGM) downlink formatter. Certain classes of BITE anomalies show an 'M' status.
- ITEM 3            SEL ID – used to designate a programmable format. Format not implemented unless item 4 initiated successfully.  
  
NOTE: TFL item entries are ignored when entered while a load is in progress and a class 5 error ('ILLEGAL ENTRY') message will result. Items should be reentered when load is complete and the SM common buffer is ready.
- ITEM 4            LOAD – used to implement item 3 designation. Text readout is 'RUN' while load in progress and ultimately 'CPLT' or 'FAIL'.  
  
NOTE: If an OPS transition is initiated while an item 3, 4 format load is in progress, the load will fail. If this occurs, reinitiate the load via items 3 and 4. (DR 37584)
- ITEM 5            I/O RESET PCM – used to enable communication with the PCMMU. An '\*\*' displayed when no BCE bypass exists; 'M' displayed during BCE bypass. This item is illegal in GNC OPS 9.

## PCMMU/PL COMM (Cont):

### ITEM ENTRY CHARACTERISTICS (Cont):

- NOTE: An 'M' is also displayed after item 5 when the PDI is powered down. Execution of item 5 will only cause momentary blanking of the 'M' in this case. The FAULT display may be checked if the user suspects that some other PMU transaction has been bypassed. (DR 55003)
- ITEMS 6 and 7      PSP I/O RESET – used to select PSP 1 or 2 for communication with payload interrogator/attached payloads. Items are mutually exclusive.
- NOTE: An attempt to reselect PSPs while a load is in progress or while polling is active with either PSP results in an 'ILLEGAL ENTRY' message. The current PSP should be powered down and become bypassed ('M' comes up) before powering up and selecting the new PSP.
- ITEM 8            PDI I/O RESET – used in SM to restore a bypassed PDI switch matrix read element. Overbright 'M' displayed when read element is bypassed; an '\*' otherwise displayed.
- Used in G9 to restore a bypassed PDI switch read matrix element or BITE status register read element. Overbright 'M' displayed if either element bypassed; an '\*' otherwise displayed.
- ITEMS 9, 10, 12    SEL DECOM/FMT/INPUT – used to select decommutator channel or FPM, and format and input, respectively. Execution of item 10 or 12 without a legal item 9 entry causes an 'ILLEGAL ENTRY' message.
- ITEMS 11 and 13    LOAD – used to initiate selections made in items 10 and 12, respectively. Text readout is 'RUN' while loading is in progress and ultimately 'CPLT' or 'FAIL'.
- ITEMS 14 thru 17    DECOM ENA – used to alternately enable/disable FDA for the loaded input source to DECOMs 1 thru 4. An '\*' is displayed next to the item when FDA is enabled; this field is blanked otherwise. These items are in the disabled state when SM software is first called and the current state is maintained across each OPS transition in which the SM major function is not overlaid. These items are not legal in OPS G9.
- ITEM 18            TFL GPC SEL – used to select the GPC which is to perform both the write to the PCMMU and the 64 and 128 KBPS read for telemetry format loads in OPS G9 only. (This field is blank in other OPS.) The GPC selected must be a member of the redundant set or the GPC for a simplex configuration.
- ITEM 19            SEL FMT ID – used only in orbit S2 to select the desired SM downlist format (FMT 24 and 26). The format number appears in the data field to the right of the item when the format is loaded. The item entry is initialized to 24 upon entry to S2. It is blanked along with its associated data field in S4, G9, and S2 SM Ground Checkout. If a format other than 24 or 26 is requested in S2, or if an item 19 is requested in any of the formats in which it is blanked, an 'ILLEGAL ENTRY' message results.
- ITEM 20            ORB C&W ⇒ ISS – Toggles 'ENA', blank in SM OPS 2 or 4 only to enable or inhibit transfer of C&W alerts to ISS for all smoke detectors, C&W Master and SM class 3 alarms. It will display blank if the function is inhibited or it is disabled due to some problem with the interface to ISS. Execution of Item 20 while in OPS G9 will be rejected with a class 5 error message.
- ITEM 21            TEST – Initiates a test command to verify the path to and from ISS for transfer of orbiter C&W command messages. 'RUN' is displayed after the EXEC. 'CPLT' is displayed if the matching ISS response is received. 'FAIL' is displayed if the function becomes inhibit for some reason after being enabled. 'RJCT' is displayed if the test is ignored. Execution of Item 21 while in OPS G9 will be rejected with a class 5 error message.

### PROGRAM NOTES

Erroneous Format Load Indications. PCMMU and PDI formats loaded on a G9 GPC (prelaunch) are not reflected on an SM-driven SPEC 62. Power-cycling the PCMMU or PDI erases the stored formats, but not the SPEC 62 indications. SPEC 62 displayed formats are blanked after an SM GPC is re-IPLed on orbit even though the loads are not changed. (no DR)

SM2 PDI Fault Message Interpretation. When the PDI is powered in SM2, but a payload data stream is not being DECOMed, PDI fault annunciation may occur without a PDI failure. Annunciations caused by payloads which are not in configuration for PDI data processing (deployed payloads, those for which lock has been lost, etc.) do not necessarily indicate PDI failure. (DR 55302)

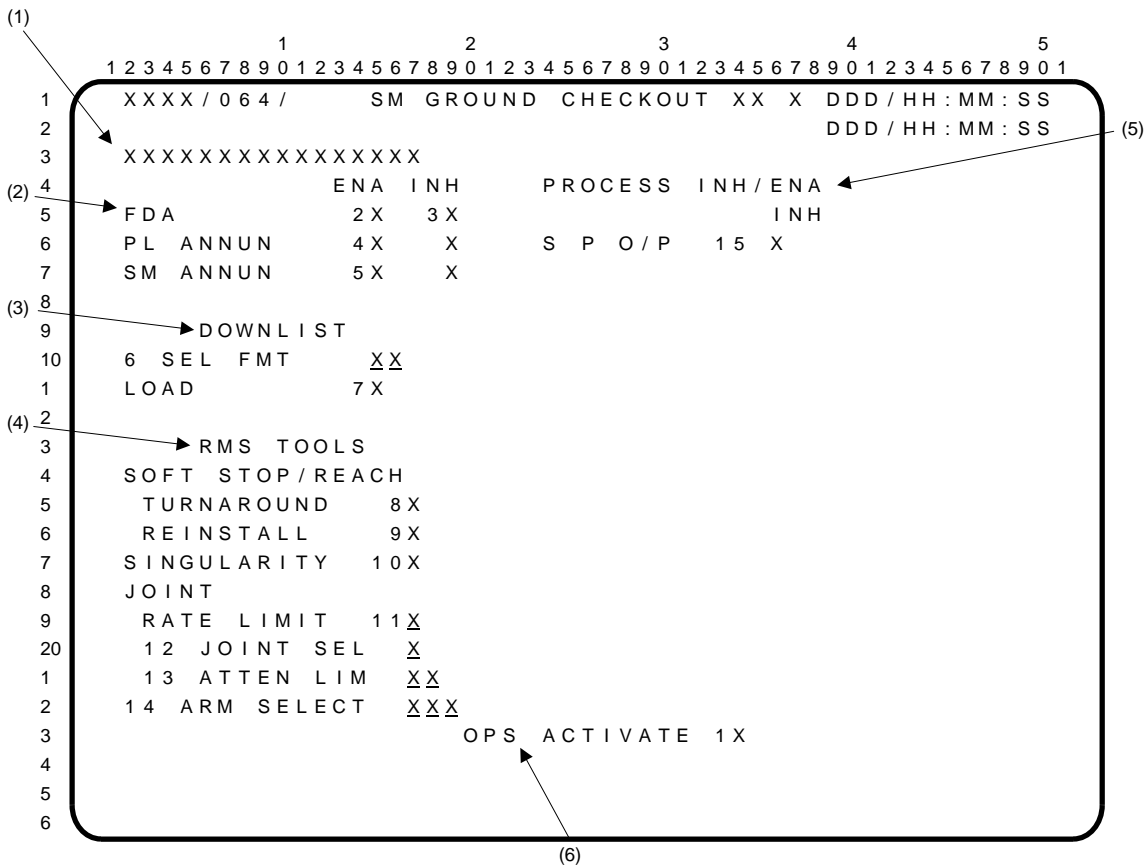

The SM GROUND CHECKOUT display is a Systems Management (SM) specialist function (SPEC 64) available in SM OPS 2 and 4 which allows the ground checkout user to modify certain SM processes to enhance vehicle turnaround and test processing. All inputs to this spec are rejected when the SM ground checkout discrete is disabled (item 52 on the DPS UTILITY display with no '\*').

- (1) This field will display 'INPUTS INHIBITED' when the SM ground checkout discrete is disabled. It will be blank at all other times.
  - (2) Items 2 and 3 are provided to enable or inhibit FDA processing. Items 4 and 5 are toggle entries to enable/inhibit the annunciation of payload or orbiter messages from the FDA function. An '\*' indicates the current selection.
  - (3) DOWNLIST. Items 6 and 7 allow for the selection and loading of downlist formats. This is valid in OPS S2 only. If the format ID is not valid, or if requested in OPS S4, the data field will blank and an 'ILLEGAL ENTRY' message displayed. Item 6 will display the selected format ID, and item 7 will display an '\*' upon execution.
  - (4) RMS TOOLS. Items 8 thru 10 provide for selection of predefined RMS table values for vehicle turnaround or arm reinstallation. Item 8 selects/deselects turnaround values for the software stops and reach limits of the arm. Item 9 selects/deselects reinstallation values for the software stops and reach limits of the arm. Items 8 and 9 are mutually exclusive. Item 10 selects/deselects the singularity joint bias value for the arm. All three are toggle items. An '\*' is displayed to indicate selection of the item, and a blank is displayed when the original values are being used.
- Item 11 allows selection of the checkout coarse joint rate limits on the unloaded arm for all six joints. Reexecuting this item restores the original values. Items 12 and 13 provide for selection of a joint (1 thru 6) and the input and/or display of the attenuation limit (0 thru 15) for the selected joint. Item 14 is used to select joint biases appropriate for the arm selected (201, 202, 301, 303) for use by RMS software.

SM GROUND CHECKOUT (Cont):

**(5)** PROCESS INH/ENA. Item 15 is used to inhibit/enable the special process outputs of the following functions:

1. Antenna Management
2. Fuel Cell Purge
3. Hydraulic Fluid Temp Control
4. Standby H2O Coolant Loop Control

An '\*' indicates these outputs are inhibited.

**(6)** OPS ACTIVATE. Item 1 is used to resume scheduling of SM processes for the SM OPS. Execution of this item (indicated by an '\*') will complete activation of the SM OPS.

	1	2	3	4	5
	1234567890	1234567890	1234567890	1234567890	1234567890
1	XXXX/XXX/066	ENVIRONMENT	XX X	DDD/HH:MM:SS	
2				DDD/HH:MM:SS	
3	CABIN		AV BAY	1 2 3	
4	dP/dT ±.XXS PRESS XX.XXS		TEMP	XXXXS XXXXS XXXXS	
5	PPO2 AIRLK P XX.XS		FAN ΔP X.XXS X.XXS X.XXS		
6	A X.XXS FAN ΔP X.XXS		SUPPLY H2O		
7	B X.XXS HX OUT T XXXS		QTY A XXXS PRESS XXXS		
8	C X.XXS CABIN T XXXS		B XXXS DMP LN T XXXS		
9	PPCO2 XX.XS		C XXXS NOZ T A XXXS		
10		1 2	D XXXS B XXXS		
1	O2 FLOW X.XS X.XS		WASTE H2O		
2	REG P XXXS XXXS		QTY 1 XXXS PRESS XXXS		
3	N2 FLOW X.XS X.XS		DMP LN T XXXS		
4	REG P XXXS XXXS		NOZ T A XXXS		
5	O2/N2 CNTL VLV XXS XXS		B XXXS		
6	H2O TK N2 P XXXS XXXS		VAC VT NOZ T XXXS		
7	N2 QTY XXXS XXXS		CO2 CNTLR 1XS 2XS		
8	EMER O2 REG P XXXXS		FILTER ΔP X.XXS		
9			PPCO2 XX.XS		
20			TEMP XXX.XS		
1		A B C ΔP	BED A PRESS XX.XS XX.XS		
2	IMU FAN XS XS XS X.XS		B PRESS XX.XS XX.XS		
3	HUMID SEP XS XS		ΔP X.XXS X.XXS		
4			VAC PRESS X.XS		
5			(XX)		
6					

The ENVIRONMENT display is an SM display (DISP 66) available in SM OPS 2 and 4 which provides data on cabin atmosphere, cabin pressure control system, IMU fans, avionics bay thermal status, water system characteristics, and regenerative CO2 removal system (RCRS).

#### PARAMETER CHARACTERISTICS

CRT NAME	UNITS	DISPLAYED RANGE	STATUS INDICATORS				
			M	H	L	↑	↓
CABIN: dP/dT	psi/min	+0.45 to -0.55	M	H	L	↑	↓
PPO2 A,B,C	psia	0 to 5	M	H	L	↑	↓
PPCO2	mmHg	0 to 30	M	H	L	↑	↓
PRESS	psia	0 to 20	M	H	L	↑	↓
AIRLK P	psid	-20 to +20	M	H	L	↑	↓
FAN ΔP	in H2O	0 to 8	M	H	L	↑	↓
HX OUT T	degF	+45 to +145	M	H	L	↑	↓
CABIN T	degF	+32 to +122	M	H	L	↑	↓
O2 FLOW	lbm/hr	0 to 5	M	H	L	↑	↓
REG P	psia	0 to 300	M	H	L	↑	↓
N2 FLOW	lbm/hr	0 to 5	M	H	L	↑	↓
REG P	psia	0 to 300	M	H	L	↑	↓
O2/N2 CNTL VLV	text	'O2' or 'N2'	M				
H2O TK N2 P	psig	0 to 20	M	H	L	↑	↓
N2 QTY	lb	0 to 460	M	H	L	↑	↓
EMER O2 REG P	psia	0 to 1500	M	H	L	↑	↓
IMU FAN A, B, C	off/on	blank or '*'	M			↑	↓
ΔP	in H2O	0 to 7.0	M	H	L	↑	↓
HUMID SEP	off/on	blank or '*'	M			↑	↓
AV BAY TEMP	degF	+45 to +145	M	H	L	↑	↓
FAN ΔP	in H2O	0 to 5 or 0 to 8	M	H	L	↑	↓
H2O: SUPPLY QTY A, B, C, D	percent	0 to 100	M	H	L	↑	↓
PRESS	psia	0 to 50	M	H	L	↑	↓
DMP LN T	degF	25 to 130	M	H	L	↑	↓
NOZ T A, B	degF	0 to 400	M	H	L	↑	↓



ENVIRONMENT (Cont):

PARAMETER CHARACTERISTICS (Cont):

CRT NAME	UNITS	DISPLAYED RANGE	STATUS INDICATORS				
			M	H	L	↑	↓
WASTE: QTY 1	percent	0 to 100	M	H	L	↑	↓
PRESS	psig	0 to 30	M	H	L	↑	↓
DMP LN T	degF	25 to 130	M	H	L	↑	↓
NOZ T A,B	degF	0 to 400	M	H	L	↑	
VAC VT NOZ T	degF	-75 to +300	M	H	L		
FILTER ΔP	in H2O	0 to 3	M	H	L	↑	↓
PPCO2	mm Hg	0 to 30	M	H	L	↑	
TEMP	degF	32 to 133	M	H	L		
BED A PRESS	psia	0 to 20	M	H	L		
B PRESS	psia	0 to 20	M	H	L		
ΔP	in H2O	0 to 5	M	H	L		
VAC PRESS	mm Hg	0 to 5	M	H	L	↑	↓
CO2 CNTLR 1,2	off/on	blank or '*'	M				

REMARKS

- [1] PPO2 'C' has no '↑' or '↓' indicators.
- [2] Status shows a '↓' if appropriate IMU fan is 'ON' and speed drops below fixed value. If no fans are 'ON', all three fans show a '↓'. 'Blank' indicates the IMU is 'OFF'; an '\*' indicates that the IMU fan has been selected.
- [3] Status shows a '↓' if appropriate humidity separator is 'ON' and speed drops below fixed value. 'Blank' indicates the humidity separator is 'OFF'; an '\*' indicates that the humidity separator has been selected.
- [4] At OPS 2 transition, the N2 Quantity computation is configured either by the crew (SPEC 60) or by the ground (TMBU) to reflect the specific N2 tank configuration flown. If the configuration is performed by the crew, reference ECLS SSR 14.
- [5] Parameter is a multidiscrete indication that requires AC power and DC power 'ON' discrete. An '\*' indicates that the system is powered, but not operating. A '↓' will appear for only 6 seconds from time of failure. Controller FAIL light on panel MO51F will remain latched during shutdown.
- [6] All vehicles have been modified to be capable of using upgraded av bay fans in Av Bay 3a. These fans are larger than standard av bay fans to provide additional cooling to Av Bay 3a payloads; they are equivalent to cabin fans. These larger fans have a different ΔP operating range and thus, different upper and lower FDA limits than those of nominal av bay fans. As of 05/18/04, there are no explicit plans to manifest the larger av bay fan on any upcoming flight.

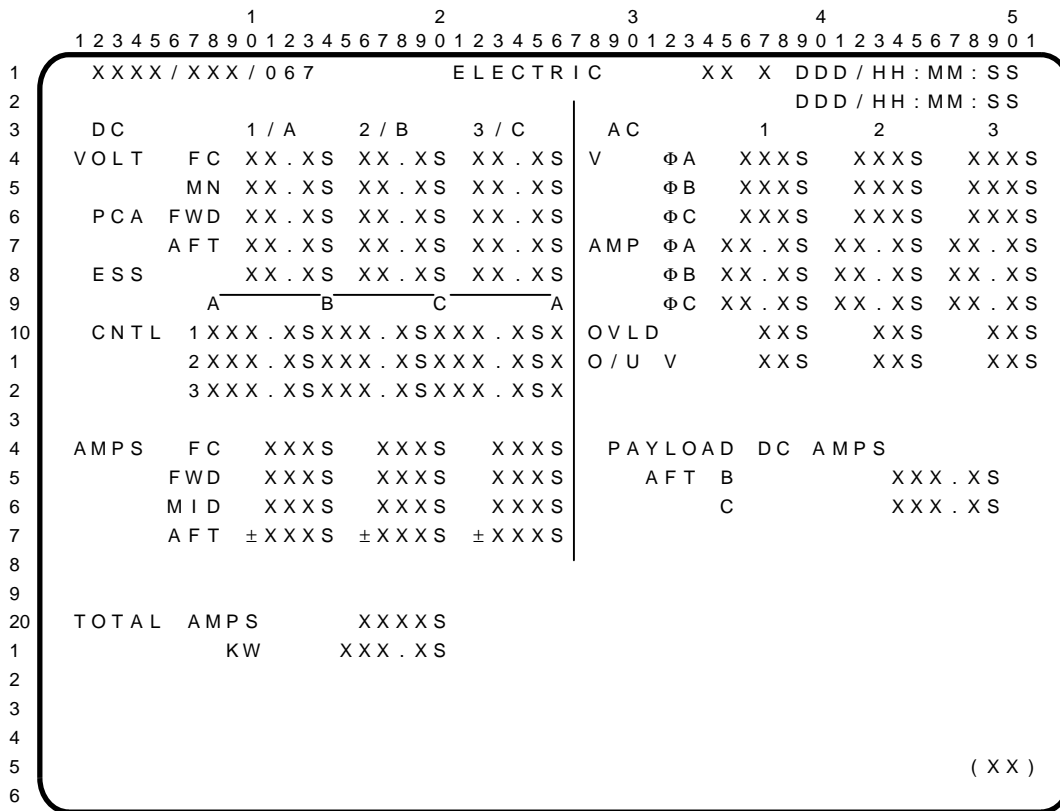

The ELECTRIC display is an SM display (DISP 67) available in SM OPS 2 and 4 which provides data on electrical power distribution and control.

#### PARAMETER CHARACTERISTICS

CRT NAME	UNITS	DISPLAYED RANGE	STATUS INDICATORS				
			M	H	L	↑	↓
DC: VOLT: FC	volts	0 to 40	M	H	L	↑	↓
MN	volts	0 to 40	M	H	L	↑	↓
PCA FWD	volts	0 to 40	M	H	L		
AFT	volts	0 to 40	M	H	L		
ESS	volts	0 to 40	M	H	L		↓
CNTL 1 [1]	volts	0 to 40	M	H	L		↓
2	volts	0 to 40	M	H	L		↓
3	volts	0 to 40	M	H	L		↓
AMPS: FC	amps	0 to 500	M	H	L	↑	↓
FWD	amps	0 to 250	M	H	L		
MID	amps	0 to 100	M	H	L		
AFT [2]	amps	0 to 175	M	H	L		
TOTAL AMPS	amps	0 to 1500	M	H	L		
kW	kW	0 to 60	M	H	L		
AC: V: ΦA,ΦB,ΦC	volts	0 to 140	M	H	L	↑	↓
AMP: ΦA,ΦB,ΦC	amps	0 to 20	M	H	L		
OVLD	text	'blank' or 'OL'	M				↓
O/U V [3]	text	'blank' or 'OU'	M				
PAYLOAD DC AMPS: AFT B	amps	0 to 75	M	H	L		
C	amps	0 to 75	M	H	L		

#### REMARKS

- [1] Each parameter is preceded/followed by an RPC trip status indicator. These indicators are located under the alpha column headers (A-B-C-A); they read '\*' if the associated RPC is OFF (blank otherwise). Examples: MNA AB1/CA1 = OFF produces an '\*' for CNTL 1 under both the left and right A; MNB AB2/BC2 = OFF produces an '\*' for CNTL 2 under the B; MNC BC3/CA3 = OFF produces an '\*' for CNTL 3 under the C.
- [2] Transducer range is -325 to +175 to accommodate GSE power; only positive values will be seen in flight.
- [3] Parameter reflects status of over/under-voltage sensing of AC Bus Voltage Sensor. If sensor and backup C/W operate properly, C/W alert 'AC VOLTAGE' would also have a CRT message (S67 AC VOLTS), an '↑' or '↓' by one or more 'AC V' parameters, and 'OU' would be displayed.

	1										2										3										4										5									
	1	2	3	4	5	6	7	8	9	0	1	2	3	4	5	6	7	8	9	0	1	2	3	4	5	6	7	8	9	0	1	2	3	4	5	6	7	8	9	0	1	2	3	4	5	6	7	8	9	0
1	XXXX/XXX/068										CRYO SYSTEM										XX X										DDD/HH:MM:SS																			
2																															DDD/HH:MM:SS																			
3											TK																																							
4	O2	1		2		3		4		5																																								
5	P	XXXXS	XXXXS	XXXXS	XXXXS	XXXXS	XXXXS	XXXXS	XXXXS	XXXXS	XXXXS																																							
6	TK P	XXXXS	XXXXS	XXXXS	XXXXS	XXXXS	XXXXS	XXXXS	XXXXS	XXXXS	XXXXS																																							
7	QTY	XXXXS	XXXXS	XXXXS	XXXXS	XXXXS	XXXXS	XXXXS	XXXXS	XXXXS	XXXXS																																							
8	T	±XXXXS	±XXXXS	±XXXXS	±XXXXS	±XXXXS	±XXXXS	±XXXXS	±XXXXS	±XXXXS	±XXXXS																																							
9	HTR T 1	±XXXXS	±XXXXS	±XXXXS	±XXXXS	±XXXXS	±XXXXS	±XXXXS	±XXXXS	±XXXXS	±XXXXS																																							
10	2	±XXXXS	±XXXXS	±XXXXS	±XXXXS	±XXXXS	±XXXXS	±XXXXS	±XXXXS	±XXXXS	±XXXXS																																							
1	HTR 1A	S	S	S	S	S	S	S	S	S	S																																							
2	CUR 1B	S	S	S	S	S	S	S	S	S	S																																							
3	SNSR 2A	S	S	S	S	S	S	S	S	S	S																																							
4	2B	S	S	S	S	S	S	S	S	S	S																																							
5	MANF P	XXXXS	XXXXS	XXXXS	XXXXS	XXXXS	XXXXS	XXXXS	XXXXS	XXXXS	XXXXS																																							
6	VLV	XXS	XXS	XXS	XXS	XXS	XXS	XXS	XXS	XXS	XXS																																							
7	H2																																																	
8	P	XXXXS	XXXXS	XXXXS	XXXXS	XXXXS	XXXXS	XXXXS	XXXXS	XXXXS	XXXXS																																							
9	TK P	XXXXS	XXXXS	XXXXS	XXXXS	XXXXS	XXXXS	XXXXS	XXXXS	XXXXS	XXXXS																																							
20	QTY	XXXXS	XXXXS	XXXXS	XXXXS	XXXXS	XXXXS	XXXXS	XXXXS	XXXXS	XXXXS																																							
1	T	±XXXXS	±XXXXS	±XXXXS	±XXXXS	±XXXXS	±XXXXS	±XXXXS	±XXXXS	±XXXXS	±XXXXS																																							
2	HTR T	±XXXXS	±XXXXS	±XXXXS	±XXXXS	±XXXXS	±XXXXS	±XXXXS	±XXXXS	±XXXXS	±XXXXS																																							
3	MANF P	XXXXS	XXXXS	XXXXS	XXXXS	XXXXS	XXXXS	XXXXS	XXXXS	XXXXS	XXXXS																																							
4	VLV	XXS	XXS	XXS	XXS	XXS	XXS	XXS	XXS	XXS	XXS																																							
5																															( X X )																			
6																																																		

The CRYO SYSTEM display is an SM display (DISP 68), available in SM OPS 2 and 4 which provides detailed status information on the cryogenic (CRYO) subsystems.

### PARAMETER CHARACTERISTICS

CRT NAME	UNITS	DISPLAYED RANGE	STATUS INDICATORS					
			M	H	L	↑	↓	
O2 TK: P	[1]	psia	515 to 1015	M	H	L	↑	↓
TK P	[1]	psia	0 to 1200	M	H	L	↑	↓
QTY		percent	0 to 104	M	H	L		
T		degF	-425 to +475	M	H	L		
HTR T 1,2		degF	-425 to +425	M	H	L	↑	↓
HTR CUR SNSR 1A,1B, 2A,2B	[2]	on/trip	'blank' or '↓'	M				↓
MANF P		psia	0 to 1200	M	H	L		↓
VLV		text	'CL' or 'OP'	M				↓
H2 TK: P	[1]	psia	145 to 305	M	H	L	↑	↓
TK P	[1]	psia	0 to 400	M	H	L	↑	↓
QTY		percent	0 to 105	M	H	L		
T		degF	-425 to +475	M	H	L		
HTR T		degF	-425 to +475	M	H	L		↓
MANF P		psia	0 to 400	M	H	L		↓
VLV		text	'CL' or 'OP'	M			↑	↓

### REMARKS

[1] 'P' is the tank pressure used by the tank heater controller. This pressure also appears on the SM SYS SUMM 2 display as 'O2(H2) PRESS'. 'TK P' is measured at approximately the same point as 'P' but is not used by the heater control unit. 'TK P' pressures are also displayed on panel O2.

[2] '↓' reflects that tank heater current was excessive, and that the appropriate heater has been inhibited.

	1									2									3									4									5								
	1	2	3	4	5	6	7	8	9	1	2	3	4	5	6	7	8	9	1	2	3	4	5	6	7	8	9	1	2	3	4	5	6	7	8	9	1	2	3	4	5	6	7	8	9
1	XXXX/XXX/069									FUEL CELLS									XX X DDD/HH:MM:SS									DDD/HH:MM:SS																	
2																																													
3										FC																																			
4										1 2 3																																			
5	VOLTS	XX.XS	XX.XS	XX.XS	XX.XS	XX.XS	XX.XS	XX.XS	XX.XS	H2O RLF LINE T									XXXXS																										
6	AMPS	XXXXS	XXXXS	XXXXS	XXXXS	XXXXS	XXXXS	XXXXS	XXXXS	NOZ T A									XXXXS																										
7										B									XXXXS																										
8	FLOW O2	XX.XS	XX.XS	XX.XS	XX.XS	XX.XS	XX.XS	XX.XS	XX.XS	HTR SW									XXXXS																										
9	H2	X.XS	X.XS	X.XS	X.XS	X.XS	X.XS	X.XS	X.XS	PURGE LN O2 T									XXXXS																										
10	REAC O2	XXS	XXS	XXS	XXS	XXS	XXS	XXS	XXS	H2 T1									XXXXS																										
1	H2	XXS	XXS	XXS	XXS	XXS	XXS	XXS	XXS	T2									XXXXS																										
2										H2O LINE PH									XXS																										
3	STACK T	±XXXXS	±XXXXS	±XXXXS	±XXXXS	±XXXXS	±XXXXS	±XXXXS	±XXXXS																																				
4	EXIT T	XXXXS	XXXXS	XXXXS	XXXXS	XXXXS	XXXXS	XXXXS	XXXXS																																				
5	COOL T	XXXXS	XXXXS	XXXXS	XXXXS	XXXXS	XXXXS	XXXXS	XXXXS																																				
6	P	XXXXS	XXXXS	XXXXS	XXXXS	XXXXS	XXXXS	XXXXS	XXXXS	FC																																			
7	PUMP	XXS	XXS	XXS	XXS	XXS	XXS	XXS	XXS	PH									1 2 3																										
8	H2 PUMP	X.XS	X.XS	X.XS	X.XS	X.XS	X.XS	X.XS	X.XS	ΔV SS1									XXXXS XXXS XXXS																										
9	READY	XXXXS	XXXXS	XXXXS	XXXXS	XXXXS	XXXXS	XXXXS	XXXXS	SS2									XXXXS XXXS XXXS																										
20										SS3									XXXXS XXXS XXXS																										
1	H2O									ΔAMPS									±XXXXS ±XXXXS ±XXXXS																										
2	PRI LN T	XXXXS	XXXXS	XXXXS	XXXXS	XXXXS	XXXXS	XXXXS	XXXXS																																				
3	VLV T	XXXXS	XXXXS	XXXXS	XXXXS	XXXXS	XXXXS	XXXXS	XXXXS																																				
4	ALT LN T	XXXXS	XXXXS	XXXXS	XXXXS	XXXXS	XXXXS	XXXXS	XXXXS																																				
5																			(XX)																										
6																																													

The FUEL CELLS display is an SM display (DISP 69) available in SM OPS 2 and 4 which provides detailed status information on the fuel cell subsystem.

**PARAMETER CHARACTERISTICS**

CRT NAME	UNITS	DISPLAYED RANGE	STATUS INDICATORS				
			M	H	L	↑	↓
FC: VOLTS	volts	0 to 40	M	H	L	↑	↓
AMPS	amps	0 to 500	M	H	L	↑	↓
FLOW O2	lbm/hr	0 to 15	M	H	L	↑	
H2	lbm/hr	0 to 2.5	M	H	L	↑	
REAC O2	text	'CL' or 'OP'	M				↓
H2	text	'CL' or 'OP'	M				↓
STACK T	degF	-75 to +300	M	H	L	↑	↓
EXIT T	degF	0 to 250	M	H	L	↑	↓
COOL T	degF	0 to 250	M	H	L	↑	↓
P	psia	0 to 100	M	H	L	↑	↓
PUMP	text	'ΔP' or 'blank'	M				↓
H2 PUMP	volts	0 to 5	M	H	L	↑	
READY	text	'OFF' or 'RDY'	M				↓
H2O PRI LN T	degF	0 to 250	M	H	L	↑	↓
VLV T	degF	0 to 250	M	H	L	↑	↓
ALT LN T	degF	0 to 250	M	H	L	↑	↓
RLF LINE T	degF	0 to 250	M	H	L	↑	↓
NOZ T A,B	degF	0 to 450	M	H	L	↑	↓
HTR SW	text	A,B, A/B, OFF	M				↓
PURGE LN O2 T	degF	0 to 400	M	H	L	↑	
H2, T1, T2	degF	0 to 400	M	H	L	↑	
H2O LINE PH	text	'blank' or 'PH'	M				↓
PH	text	'blank' or 'PH'	M				↓
ΔV SS 1,2,3	mvdc	0 to 500	M	H	L	↑	
ΔAMPS	amps	-500 to 500	M				↓

**REMARKS**

- [1] 'PH' and '↓' appear when fuel cell pH is outside of normal range.
- [2] Fuel Cell Delta Amps are calculated by subtracting the current of FC2 from FC1, FC3 from FC2, and FC1 from FC3. The difference, positive or negative, is displayed as ΔAMPS 1, 2, and 3, respectively.

	1										2										3										4										5									
	1	2	3	4	5	6	7	8	9	0	1	2	3	4	5	6	7	8	9	0	1	2	3	4	5	6	7	8	9	0	1	2	3	4	5	6	7	8	9	0	1	2	3	4	5	6	7	8	9	0
1	XXXX/XXX/076										COMMUNICATIONS										XX X										DDD/HH:MM:SS																			
2																															DDD/HH:MM:SS																			
3	S-BAND PM										XXXXXS										KU-BAND																													
4	FREQ										XXS 1 2										PA TEMP										±XXXXS																			
5	ANT ELEC										XXS XXS										GIMBAL TEMP A										±XXXXS																			
6	XPNDR										XXS XXS										B										±XXXXS																			
7	PREAMP										XXS XXS										GYRO TEMP										±XXXXS																			
8	PWR AMPL																				PWR OUT										XXS																			
9	OPER										XXS XXS										FRM SYNC										XXXXS																			
10	STBY										XXXXXS XXXXS										MODE										XXXXXS																			
1	PWR OUT										XXXXS XXXXS										FAIL SAFE										XXXXS																			
2	TEMP										XXXXS XXXXS										AUTO K TO S										XXX																			
3	NSP										1 2										AUTO S TO K										XXX																			
4	BIT SYNC										XXXXS XXXXS										SSOR										1 2																			
5	FRM SYNC										XXXXS XXXXS										FRM SYNC										XXXXS XXXXS																			
6	BITE										XXXXXS XXXXS										PROC STAT										XXXXS XXXXS																			
7	COMSEC BITE										XXXXXS XXXXS										PWR LEVEL										±XX.XS																			
8																					STATUS										X.XS																			
9	UL DATA SOURCE										XXS										GCIL CONFIG										XXXXS																			
20	DATA RATE XMIT										XXS										CCTV CAMR OVRTMP										XXXXS																			
1	RCV										XXS																																							
2	CODING XMIT										XXXXS																																							
3	RCV										XXXXS																																							
4																																																		
5																																																		
6																															(XX)																			

The COMMUNICATIONS display is an SM display (DISP 76) available in SM OPS 2 and 4 which provides data on the configuration and condition of the communications system.

**PARAMETER CHARACTERISTICS**

CRT NAME	UNITS	DISPLAYED RANGE	STATUS INDICATORS					
			M	H	L	↑	↓	
S-BAND PM:	[1]	text	See Remarks	M				
FREQ		text	'LO' or 'HI'	M				
ANT ELEC 1,2		text	'blank' or 'ON'	M				
XPNDR 1,2		text	'blank' or 'ON'	M				
PREAMP 1,2		text	'blank' or 'ON'	M				
PWR AMPL OPER 1,2		text	'blank' or 'ON'	M				
STBY 1,2		text	'blank' or 'STBY'	M				
OUT 1,2		watts	0 to 150	M	H	L		↓
TEMP 1,2		degF	32 to 266	M	H	L	↑	
NSP: BIT SYNC 1,2		text	'YES' or 'NO'	M				
FRM SYNC 1,2		text	'YES' or 'NO'	M				
BITE 1,2		text	'GOOD' or 'FAIL'	M				
COMSEC BITE 1,2		text	'GOOD' or 'FAIL'	M				
UL DATA SOURCE	[1]	text	'S' or 'KU'	M				
DATA RATE XMIT	[1]	text	'LO' or 'HI'	M				
RCV	[1]	text	'LO' or 'HI'	M				
CODING XMIT		text	'OFF' or 'ON'	M				
RCV		text	'OFF' or 'ON'	M				
KU-BAND: PA TEMP		degF	-75 to +300	M	H	L	↑	↓
GMBL TEMP A,B		degF	-75 to +300	M	H	L	↑	
GYRO TEMP		degF	-75 to +300	M	H	L	↑	
PWR OUT		watts	0 to 30	M	H	L		
FRM SYNC		text	'YES' or 'NO'	M				
MODE		text	'RDR' or 'COMM'	M				
FAIL SAFE		text	'ENA' or 'INH'	M				
AUTO K TO S		text	'ENA' or 'INH'					
AUTO S TO K		text	'ENA' or 'INH'					

COMMUNICATIONS (Cont):

PARAMETER CHARACTERISTICS (Cont):

CRT NAME	UNITS	DISPLAYED RANGE	STATUS INDICATORS				
			M	H	L	↑	↓
SSOR FRM SYNC 1,2 PROC STAT 1,2 PWR LEVEL STATUS	text	'YES' or 'NO'	M				
	text	'OK' or 'BAD'	M				
	dBm	+15 to +45	M	H	L		
	amps	0 to +15	M	H	L		
GCIL CONFIG [2]	text	'PNL' or 'CMD'	M				↓
CCTV CAMR OVRTMP	text	'YES' or 'NO'	M				↓

REMARKS

- [1] A blank field indicates both LRUs are unpowered.
- [2] 'CMD' indicates that the GCIL is configured to control the S-band, Ku-band, and TV power functions. 'PNL' indicates that the functions are under panel control. GCIL powerup, multiple power supply failures, or multiple electrical bus transients cause 'PNL' to be displayed with a '↓'.

```

1 2 3 4 5 6 7 8 9 0 1 2 3 4 5 6 7 8 9 0 1 2 3 4 5 6 7 8 9 0 1
1  XXXX/XXX/077      EVA-MMU/FSS      XX X DDD/HH:MM:SS
2                                     XX X DDD/HH:MM:SS
3  MMU/FSS
4  TEMPS           PORT      STBD
5  TOGGLE VLV FSS  L ±XXXXS ±XXXXS
6                                     R ±XXXXS ±XXXXS
7                                     MMU L ±XXXXS ±XXXXS
8                                     R ±XXXXS ±XXXXS
9  GN2 TANK BARREL L ±XXXXS ±XXXXS
10                                    R ±XXXXS ±XXXXS
1  CNTL ELECT ASSY ±XXXXS ±XXXXS
2
3
4
5
6
7
8
9
20
1
2
3
4
5
6
(X X)

```

The EVA-MMU/FSS display is an SM display (DISP 77) available in SM OPS 2 and 4. It is used for thermal monitoring of the Manned Maneuvering Unit (MMU) and its associated Flight Support Station (FSS) prior to operational use and during reseriving of the GN2 propulsion system. The crew may also view the display as a result of an FDA alert/CRT message.

PARAMETER CHARACTERISTICS

CRT NAME	UNITS	DISPLAYED RANGE	STATUS INDICATORS				
			M	H	L	↑	↓
TEMPS: TOGGLE VLV FSS L,R	degF	-75 to +175	M	H	L	↑	↓
MMU L,R	degF	-75 to +175	M	H	L	↑	↓
GN2 TANK BARREL L	degF	-75 to +300	M	H	L	↑	↓
R	degF	-75 to +175	M	H	L	↑	↓
CNTL ELECT ASSY	degF	-75 to +175	M	H	L	↑	↓

	1	2	3	4	5
	12345678901	2345678901	2345678901	2345678901	2345678901
1	XXXX/XXX/078		SM SYS SUMM 1	XX X	DDD/HH:MM:SS
2					DDD/HH:MM:SS
3	SMOKE	1/A 2/B	DC VOLTS	1/A 2/B 3/C	
4	CABIN	XX.XS	FC	XX.XS XX.XS XX.XS	
5	L/R FD	XX.XS XX.XS	MAIN	XX.XS XX.XS XX.XS	
6	AV BAY 1	XX.XS XX.XS	ESS	XX.XS XX.XS XX.XS	
7		2 XX.XS XX.XS		A-----B-----C-----A	
8		3 XX.XS XX.XS	CNTL 1	XXX.XSXXX.XSXXX.XSX	
9	CABIN		2	XXX.XSXXX.XSXXX.XSX	
10	PRESS	XX.XXS	3	XXX.XSXXX.XSXXX.XSX	
1	dP/dT-EQ	±.XXS±X.XXS	SAC		
2	O2 CONC	XX.XS	VOLT ΦA	XXXS XXXS XXXS	
3	PPO2	X.XXS X.XXS	ΦB	XXXS XXXS XXXS	
4	FAN ΔP	X.XXS	ΦC	XXXS XXXS XXXS	
5	HX OUT T	XXXS	AMPS ΦA	XX.XS XX.XS XX.XS	
6	O2 FLOW	XX.XS XX.XS	ΦB	XX.XS XX.XS XX.XS	
7	N2 FLOW	XX.XS XX.XS	ΦC	XX.XS XX.XS XX.XS	
8	IMU FAN	AXS BXS CXS	FUEL CELL		
9	ΔV FC1 FC2 FC3		AMPS	XXXS XXXS XXXS	
20	SS1	XXXS XXXS XXXS	REAC VLV	XXS XXS XXS	
1	SS2	XXXS XXXS XXXS	STACK T	±XXXS ±XXXS ±XXXS	
2	SS3	XXXS XXXS XXXS	EXIT T	XXXS XXXS XXXS	
3	TOTAL AMPS	XXXXS	COOL P	XXXS XXXS XXXS	
4		KW XXS	PUMP	XXS XXS XXS	
5					(XX)
6					

The SM SYS SUMM 1 display is an SM display (DISP 78) available in SM OPS 2 and 4 and in BFS OPS 0 which provides summary data on emergency, atmospheric (cabin), and electrical power distribution and generation parameters.

### PARAMETER CHARACTERISTICS

CRT NAME	UNITS	DISPLAYED RANGE	STATUS INDICATORS				
			M	H	L	↑	↓
SMOKE: CABIN	[1] mgm/M <sup>3</sup>	0 to 15	M	H	L	↑	
L/R FD	[1] mgm/M <sup>3</sup>	0 to 15	M	H	L	↑	
AV BAY 1,2,3	[1] mgm/M <sup>3</sup>	0 to 15	M	H	L	↑	
CABIN: PRESS	psia	0 to 20	M	H	L	↑	↓
dP/dT	[2] psi/min	+0.45 to -0.55	M	H	L		↓
EQ	[3] psi/min	-2.000 to +2.000	M	H	L		↓
O2 CONC	[4] pct	0 to 100	M	H	L	↑	
PPO2	psia	0 to 5	M	H	L	↑	↓
FAN ΔP	in H2O	0 to 8	M	H	L	↑	↓
HX OUT T	degF	+45 to +145	M	H	L	↑	
O2 FLOW	lbm/hr	0 to 5	M	H	L	↑	
N2 FLOW	lbm/hr	0 to 5	M	H	L		
IMU FAN A,B,C	[5] text	blank or '*'	M				↓
ΔV SS 1,2,3	mvdc	0 to 500	M	H	L	↑	
TOTAL: AMPS	amps	0 to 1500	M				
kW	kW	0 to 60	M				
DC VOLTS: FC	volts	0 to 40	M	H	L	↑	↓
MAIN	volts	0 to 40	M	H	L	↑	↓
ESS	volts	0 to 40	M	H	L		↓
CNTL 1,2,3	[6] volts	0 to 40	M	H	L		↓
AC: VOLT ΦA, ΦB, ΦC	volts	0 to 140	M	H	L	↑	↓
AMPS ΦA, ΦB, ΦC	amps	0 to 20	M	H	L		
FUEL CELL: AMPS	amps	0 to 500	M	H	L	↑	↓
REAC VLV	[7] text	'CL' or 'OP'	M				↓
STACK T	degF	-75 to +300	M	H	L	↑	↓
EXIT T	degF	0 to 250	M	H	L	↑	↓
COOL P	psia	0 to 100	M	H	L	↑	↓
PUMP	text	'ΔP' or blank	M				↓



SM SYS SUMM 1 (Cont):

REMARKS

- [1]** The hardwired smoke emergency alert can also be initiated by smoke rate-of-increase (not shown on CRT). There is no software triggered emergency alert for smoke rate of increase.
- [2]** The dP/dT hardware status field shows an 'H' for an off-scale pressure leak (greater than -.5 psi/min).
- [3]** EQ dP/dT is the equivalent dP/dT at 14.7 for the current Cabin Pressure and dP/dT. The EQ dP/dT field format range is  $\pm 2.000$ . If either Cabin Press or dP/dT is missing, the last computed values of EQ dP/dT and 'M' displayed.
- [4]** The O2 CONC calculation automatically disregards PPO2 A, B, or C inputs which are missing 'M'. The crew can manually remove a PPO2 input from the calculation by disabling the corresponding PPO2 ENABLE constant on SM SPEC 60. If all three PPO2 inputs are disabled, 'NOK' (not OK) is displayed. If all enabled PPO2 inputs are missing or if Cabin Press is missing, the last computed values of O2 CONC and 'M' are displayed. O2 CONC values greater than 100 percent can be displayed.
- [5]** Status shows a '↓' if appropriate IMU FAN is 'on' and speed drops below fixed value, or the IMU FAN speed sensor is unpowered or failed. 'Blank' indicates that the IMU FAN is 'off' or the 'on' discrete is failed. The '\*', powered by phase A of the respective AC bus, indicates which IMU FAN has been selected.
- [6]** Each parameter is preceded/followed by an RPC trip status indicator. These indicators are located under the alpha column headers (A-B-C-A); they read '\*' if the associated RPC is ON (blank otherwise). Examples: AB1/CA1 RPC = ON produces an '\*' for CNTL 1 under the leftmost A; BC1/CA1 RPC = ON produces an '\*' under the rightmost A.
- [7]** Either H2 or O2 valve closed causes a '↓'.

	1										2										3										4										5																																							
	1	2	3	4	5	6	7	8	9	0	1	2	3	4	5	6	7	8	9	0	1	2	3	4	5	6	7	8	9	0	1	2	3	4	5	6	7	8	9	0	1	2	3	4	5	6	7	8	9	0																														
1	XXXX/XXX/079										SM SYS SUMM 2										XX X										DDD/HH:MM:SS																																																	
2																															DDD/HH:MM:SS																																																	
3																																																																																
4	CRYO TK 1										2										3										4										5										MANF1										MANF2																			
5	H2 PRESS XXXS										XXXS										XXXS										XXXS										XXXS										XXXS										XXXS																			
6	O2 PRESS XXXXS										XXXXS										XXXXS										XXXXS										XXXXS										XXXXS										XXXXS																			
7	HTR T1 ±XXXS										±XXXS										±XXXS										±XXXS										±XXXS										±XXXS										±XXXS																			
8	T2 ±XXXS										±XXXS										±XXXS										±XXXS										±XXXS										±XXXS										±XXXS																			
9																																																																																
10	APU 1										2										3										HYD 1										2										3																													
1	TEMP EGT XXXXS										XXXXS										XXXXS										PRESS XXXXS										XXXXS										XXXXS																													
2	B/U EGT XXXXS										XXXXS										XXXXS										RSVR T XXXS										XXXS										XXXS																													
3	OIL IN XXXS										XXXS										XXXS										P XXXS										XXXS										XXXS																													
4	OUT XXXS										XXXS										XXXS										QTY XXXS										XXXS										XXXS																													
5	SPEED % XXXS										XXXS										XXXS										W/B																																																	
6	FUEL QTY XXXS										XXXS										XXXS										H2O QTY XXXS										XXXS										XXXS																													
7	PMP LK P XXS										XXS										XXS										BYP VLV XXXS										XXXS										XXXS																													
8	OIL OUT P XXXS										XXXS										XXXS																																																											
9																															THERM CNTL 1										2																																							
20	AV BAY																														H2O PUMP P XXXS										XXXS										XXXS																													
1	TEMP XXXS										XXXS										XXXS										FREON FLOW XXXXS										XXXXS										XXXXS																													
2	FAN ΔP X.XXS										X.XXS										X.XXS										EVAP OUT T XXXS										XXXS										XXXS																													
3																																																																																
4																																																																																
5																																																																																
6																																																																							(XX)									

The SM SYS SUMM 2 display is an SM display (DISP 79) available in SM OPS 2 and 4 which provides summary data on cryogenics, auxiliary power units, hydraulics, water boilers, thermal control, and avionics cooling.

**PARAMETER CHARACTERISTICS**

CRT NAME	UNITS	DISPLAYED RANGE	STATUS INDICATORS				
			M	H	L	↑	↓
CRYO TANK: H2 PRESS	[1] psia	145 to 305	M	H	L	↑	↓
O2 PRESS	[1] psia	515 to 1015	M	H	L	↑	↓
HTR T1	degF	-425 to +475	M	H	L	↑	↓
T2	degF	-425 to +475	M	H	L	↑	↓
MANF 1,2: H2 PRESS	psia	0 to 400	M	H	L		↓
O2 PRESS	psia	0 to 1200	M	H	L		↓
APU: TEMP EGT	degF	0 to 1500	M	H	L		
B/U EGT	degF	0 to 1500	M	H	L	↑	
OIL IN	degF	0 to 500	M	H	L	↑	
OUT	degF	0 to 400	M	H	L	↑	↓
SPEED %	percent	0 to 167	M	H	L		
FUEL QTY	percent	0 to 100	M	H	L		↓
PMP LK P	[2] psia	0 to 50	M	H	L		
OIL OUT P	psia	0 to 200	M	H	L	↑	↓
AV BAY: TEMP	degF	45 to 145	M	H	L	↑	
FAN ΔP	in H2O	0 to 5	M	H	L	↑	↓
HYD: PRESS	psia	0 to 4000	M	H	L		↓
RSVR T	degF	-75 to +300	M	H	L	↑	↓
P	psia	0 to 250	M	H	L		↓
QTY	percent	0 to 100	M	H	L	↑	↓
W/B: H2O QTY	percent	0 to 100	M	H	L		↓
BYP VLV	text	'BYP' or 'W/B' or 'blank'	M				
THERM CNTL H2O PUMP P	psia	0 to 150	M	H	L	↑	↓
FREON FLOW	lbm/hr	730 to 2700	M	H	L		↓
EVAP OUT T	degF	25 to 130	M	H	L	↑	↓

SM SYS SUMM 2 (Cont):

REMARKS

- [1]** These pressures also appear at 'P' (O<sub>2</sub>/H<sub>2</sub>) on the CRYO SYSTEM (DISP 68) display and are used by the tank heater controller.
- [2]** Measured at fuel pump drain line and is representative of leak rate.

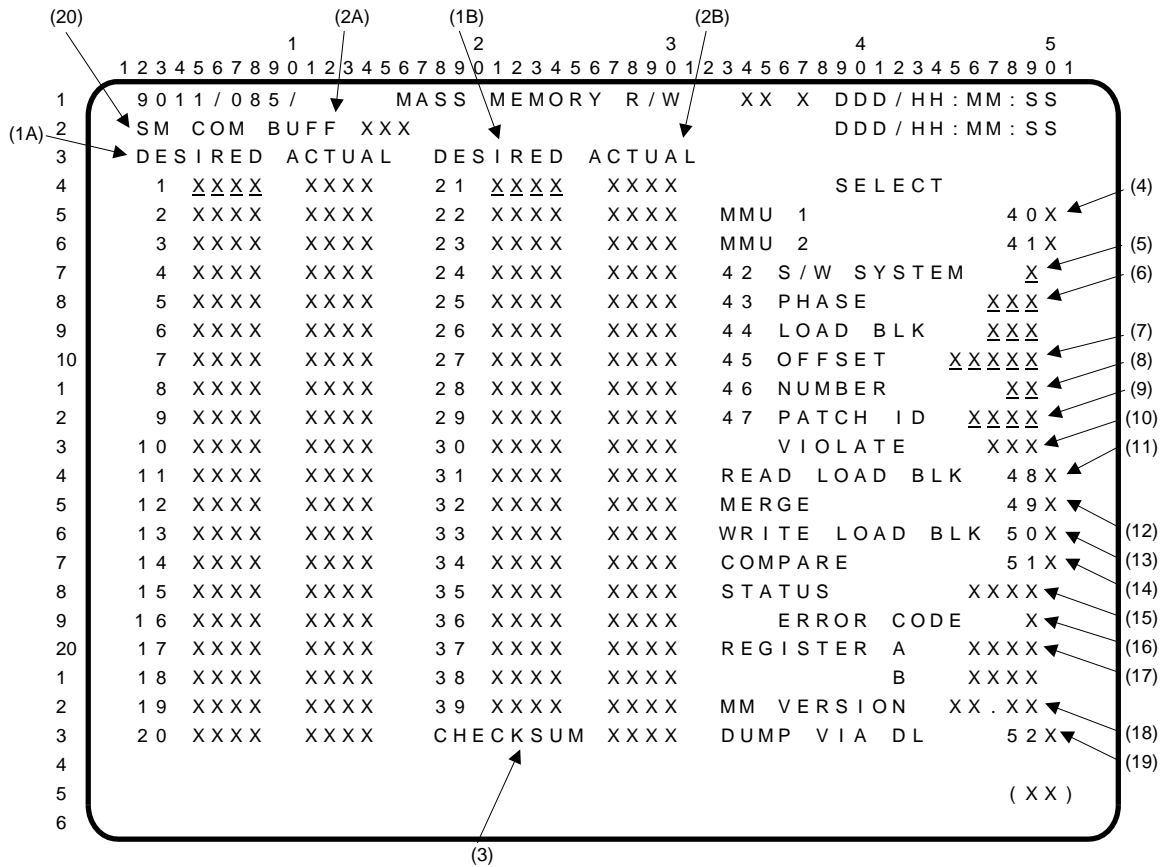

The MASS MEMORY R/W display is the mode display in PL OPS 9 (OPS 9011) and a specialist function in SM OPS 2 and 4 (SPEC 85). It includes the controls to display (READ) and modify (MERGE/WRITE) data on both Mass Memory Units (MMUs). In addition, it provides controls to dump either MMU and to compare one to the other.

- (1A) (1B) Items 1 thru 39 are used to enter the desired contents (DESIRED) for an MMU load block, starting at the OFFSET defined by item 45. Entries are made in hexadecimal.
- (2A) (2B) The actual values (ACTUAL) are displayed representing the contents of the load block selected in hexadecimal.
- (3) CHECKSUM represents the checksum (in hexadecimal) that came with the reading of the load block and is updated to the new checksum when item 49 is selected.
- (4) Items 40 and 41 select MMU 1 or 2 from which to obtain the load block and perform the writes.
- (5) Item 42 (S/W SYSTEM) is used to enter the desired software (S/W) system ID which the load block will reference as follows:

Item 42 value	Load Block
0 (Initialized)	Display Text & Graphics
1	PASS 1
2	PASS 2
3	PASS 3
4	BFS
5	DEU
6	SSME
7	TCS SEQUENCE
8	Not Supported
9	Not Supported

- (6) Item 43 (PHASE) and item 44 (LOAD BLK) define the phase and load block, respectively, in decimal. A phase entry of zero causes the Revision Patch Log (RPL) to be retrieved for the display. Fields for items 1 thru 39, 45 thru 47 blank when item 43 or 44 is entered.

## MASS MEMORY R/W (Cont):

- (7)** Item 45 (OFFSET) defines the offset (in decimal) into the load block for which items 1 thru 39 apply.
- (8)** Item 46 (NUMBER) defines the number (in decimal) of contiguous changes that are made at the current offset (max 39). A corresponding number of desired items must be made prior to the acceptance of a merge request (item 49).
- (9)** Item 47 (PATCH ID) is the PATCH ID which must be logged on RPL as part of the merge and write request. Input is in hexadecimal.
- (10)** Violate – A remote text which indicates the following:
  - 'YES' indicates that a patch ID of zeroes has been used in the write of a patch or that an unsuccessful patch write was pending when an OPS transition or SPEC termination is processed.
  - 'NO' indicates that no violations are present.
- (11)** Item 48 (READ LOAD BLK) causes the designated load block to be read from the user-selected MMU into the load block construction buffer. An '\*' is displayed adjacent to the item when entered and is blanked when 'STATUS' is blanked.
- (12)** Item 49 (MERGE) overlays the desired data into the load block construction buffer, making the DESIRED and ACTUAL columns equal. An '\*' is displayed adjacent to the item when entered and is blanked when 'STATUS' is blanked.
- (13)** Item 50 (WRITE LOAD BLK) causes the GPC to write data from the load block construction buffer to the selected MMU. The PATCH ID (item 47) is written to the same MMU as part of the write sequence. An '\*' is displayed adjacent to the item entered and is blanked when 'STATUS' is blanked. The first item 50 causes data to be written to the MMU and system ID selected for the initial read-merge operation. Reselection of the MMU, system ID, and patch ID followed by another item 50 causes the same data to be written to an alternate area on the same or alternate MMU.
- (14)** Item 51 (COMPARE) causes the GPC to perform a word-by-word comparison of the specified load block between MMU 1 and MMU 2. An error condition is displayed in accordance with error definitions provided for 'STATUS'. An '\*' is displayed when a compare function is in progress and is cleared upon completion of the compare process. Item 51 may be reentered if I/O errors are encountered.
- (15)** STATUS is an indication of the state of a process. 'IP' indicates in progress. 'CPLT' indicates that a READ (item 48), MERGE (item 49), WRITE (item 50), COMPARE (item 51), or DUMP (item 52) process has been completed without error. 'ERR' indicates an error has occurred during a process.
- (16)** ERROR CODE is a decimal code indicating what type of error has occurred during a process.
- (17)** REGISTER A and REGISTER B contain the selected MMUs latest status registers A and B from systems software COMPOOL. Displayed in hexadecimal.
- (18)** MM VERSION indicates the MM version as stored in the RPL and is updated each time the RPL is read.
- (19)** Item 52 (DUMP VIA DL) causes a dump of the selected load block via downlist.
- (20)** SM COM BUFF. 'BSY' is displayed flashing when the SM COM BUFF is in use. 'RDY' is displayed nonflashing otherwise.

	1										2										3										4										5									
	1	2	3	4	5	6	7	8	9	0	1	2	3	4	5	6	7	8	9	0	1	2	3	4	5	6	7	8	9	0	1	2	3	4	5	6	7	8	9	0	1	2	3	4	5	6	7	8	9	0
1	XXXX/XXX/086										APU/HYD										XX X										DDD/HH:MM:SS																			
2																															DDD/HH:MM:SS																			
3	APU										1 2 3										HYD										1 2 3																			
4	B/U	EGT	XXXX	XS	XXXX	XS	XXXX	XS	XXXX	XS	B/U	P	XXXX	XS	XXXX	XS	XXXX	XS	XXXX	XS	RSVR	T	XXXX	XS	XXXX	XS	XXXX	XS	XXXX	XS																				
5	EGT										XXXXXSXXXXXSXXXXXS										RSVR										T XXXS XXXS XXXS																			
6	SPEED %										XXXXS XXXS XXXS										P										XXXXS XXXS XXXS																			
7	FUEL QTY										XXXXS XXXS XXXS										QTY										XXXXS XXXS XXXS																			
8	TK P										XXXXS XXXS XXXS										ACCUM P										XXXXS XXXS XXXS																			
9	OUT P										XXXXS XXXS XXXS																																							
10	TK VLV A										XXS XXS XXS																																							
1	A T										XXXXS XXXS XXXS																																							
2	B										XXS XXS XXS																																							
3	B T										XXXXS XXXS XXXS										W/B										1 2 3																			
4	OIL T										XXXXS XXXS XXXS																																							
5	OUT T										XXXXS XXXS XXXS										CNTLR										XXX XXX XXX																			
6	OUT P										XXXXS XXXS XXXS										H2O QTY										XXXXS XXXS XXXS																			
7	GBX P										XXXXS XXXS XXXS										N2 P										XXXXS XXXS XXXS																			
8	N2 P										XXXXS XXXS XXXS										T										XXXXS XXXS XXXS																			
9	BRG T										XXXXS XXXS XXXS										REG P										XXXXS XXXS XXXS																			
20	GG BED T										XXXXS XXXS XXXS										BYP VLV										XXXXS XXXS XXXS																			
1	PUMP/VLV																				VENT T										±XXXXS ±XXXXS ±XXXXS																			
2	PMP T										XXXXS XXXS XXXS										TANK T										±XXXXS ±XXXXS ±XXXXS																			
3	VLV T										XXXXS XXXS XXXS										BLR T										±XXXXS ±XXXXS ±XXXXS																			
4																																																		
5																															(XX)																			
6																																																		

The APU/HYD display is an SM display (DISP 86) available in SM OPS 2 and 4 which provides data on the Auxiliary Power Unit (APU) and Hydraulic (HYD) subsystems.

**PARAMETER CHARACTERISTICS**

CRT NAME	UNITS	DISPLAYED RANGE	STATUS INDICATORS				
			M	H	L	↑	↓
APU: B/U EGT	degF	0 to 1500	M	H	L	↑	
EGT	degF	0 to 1500	M	H	L	↑	
SPEED %	percent	0 to 167	M	H	L	↑	
FUEL QTY	percent	0 to 100	M	H	L		↓
TK P	psia	0 to 500	M	H	L	↑	↓
OUT P	psia	0 to 500	M	H	L	↑	↓
TK VLV A,B T	degF	0 to 250	M	H	L	↑	↓
VLV A,B	text	'OP' or 'CL'	M				
OIL T	degF	0 to 500	M	H	L	↑	↓
OUT T	degF	0 to 400	M	H	L	↑	↓
P	psia	0 to 200	M	H	L	↑	↓
GBX P	psia	0 to 30	M	H	L		↓
N2 P	psia	0 to 300	M	H	L		↓
BRG T	degF	0 to 500	M	H	L	↑	
GG BED T	degF	0 to 500	M	H	L		↓
PUMP/VLV							
PMP T	degF	0 to 250	M	H	L	↑	
VLV T	degF	0 to 250	M	H	L	↑	
HYD: B/U P	psia	0 to 4000	M	H	L		↓
RSVR T	degF	-75 to +300	M	H	L	↑	↓
P	psia	0 to 250	M	H	L		↓
QTY	percent	0 to 100	M	H	L	↑	↓
ACCUM P	psia	0 to 4000	M	H	L		↓
W/B: CNTLR	text	'A', 'B', 'A/B', or 'OFF'					
H2O QTY	percent	0 to 100	M	H	L		↓
N2 P	psia	0 to 3500	M	H	L		↓
T	degF	32 to 221	M	H	L		↓
REG P	psia	0 to 75	M	H	L	↑	↓
BYP VLV	text	'BYP' or 'W/B' or 'blank'	M				
VENT T	degF	122 to 185	M	H	L	↑	
TANK T	degF	32 to 221	M	H	L	↑	↓
BLR T	degF	32 to 212	M	H	L	↑	↓

APU/HYD (Cont):

REMARKS

- [1]** 'A/B' displayed for CNTLR/HTR position indicates that both 'A' and 'B' CNTLR/HTR status indicators are on, which in turn indicates a possible MDM or CNTLR/HTR switch failure. CNTLR 'A' QTY and temperatures are displayed.
- [2]** Parameters blank when APU/HYD BLR CNTL PWR/HTR switch is OFF and are momentarily blank when switched to 'B'.

	1									2									3									4									5								
	1	2	3	4	5	6	7	8	9	1	2	3	4	5	6	7	8	9	1	2	3	4	5	6	7	8	9	1	2	3	4	5	6	7	8	9	1	2	3	4	5	6	7	8	9
1	XXXX/XXX/087									HYD THERMAL									XX X									DDD/HH:MM:SS																	
2																												DDD/HH:MM:SS																	
3																												CIRC PUMP CONTROL																	
4	HYD									1									2									3																	
5	CIRC PMP P									XXXXS									XXXXS									XXXXS																	
6	PMP BDY T									±XXXXS									±XXXXS									±XXXXS																	
7	RSVR T									±XXXXS									±XXXXS									±XXXXS																	
8	ACCUM P									±XXXXS									±XXXXS									±XXXXS																	
9	HX IN T									±XXXXS									±XXXXS									±XXXXS																	
10	OUT T									±XXXXS									±XXXXS									±XXXXS																	
1																												BDYFLP PDU ±XXXXS ±XXXXS ±XXXXS																	
2	SW VLV PR S1 S2																											FUS ±XXXXS ±XXXXS ±XXXXS																	
3	ELEV L OB 3XS 1XS 2XS									L BRAKE WHL																		±XXXXS ±XXXXS																	
4	IB 2XS 1XS 3XS																											FUS ±XXXXS ±XXXXS																	
5	R IB 3XS 1XS 2XS									R BRAKE WHL																		±XXXXS ±XXXXS ±XXXXS																	
6	OB 2XS 1XS 3XS																											FUS ±XXXXS ±XXXXS ±XXXXS																	
7	RUD/SPDBK 1XS 2XS 3XS									NG UPLK ±XXXXS																																			
8																												MFUS 1 ±XXXXS																	
9	TIRE PRESS																											MFUS 2 ±XXXXS																	
20	MG LEFT RIGHT									MG L UPLK ±XXXXS																																			
1	IB XXXS XXXS XXXS XXXS									MG R UPLK ±XXXXS																																			
2	OB XXXS XXXS XXXS XXXS																											FUS ±XXXXS																	
3	NG XXXS XXXS XXXS XXXS																																												
4																												(XX)																	
5																																													
6																																													

The HYD THERMAL display is an SM display (DISP 87) available in SM OPS 2 and 4 which provides data on the hydraulic systems and tire pressure monitoring.

### PARAMETER CHARACTERISTICS

CRT NAME	UNITS	DISPLAYED RANGE	STATUS INDICATORS				
			M	H	L	↑	↓
HYD: CIRC PMP P	psia	0 to 800	M	H	L	↑	↓
PMP BDY T	degF	-75 to +300	M	H	L	↑	↓
RSVR T	degF	-75 to +300	M	H	L	↑	↓
ACCUM P	psia	0 to 4000	M	H	L	↑	↓
HX IN T	degF	-75 to +300	M	H	L	↑	↓
OUT T	degF	-75 to +300	M	H	L	↑	↓
SW VLV [1]	text	** or blank					
TIRE PRESS							
MG IB L,R	psia	260 to 460	M	H	L	↑	↓
OB L,R	psia	260 to 460	M	H	L	↑	↓
NG OB L,R	psia	260 to 460	M	H	L	↑	↓
CIRC PUMP CONTROL LINE TEMPS							
ELEVON LOB	degF	-75 to +300	M	H	L	↑	↓
LIB	degF	-75 to +300	M	H	L	↑	↓
RIB	degF	-75 to +300	M	H	L	↑	↓
ROB	degF	-75 to +300	M	H	L	↑	↓
RD/SB PDU	degF	-75 to +300	M	H	L	↑	↓
FUS	degF	-75 to +300	M	H	L	↑	↓
BDYFLP PDU	degF	-75 to +300	M	H	L	↑	↓
FUS	degF	-75 to +300	M	H	L	↑	↓
L BRAKE WHL	degF	-75 to +300	M	H	L	↑	↓
FUS	degF	-75 to +300	M	H	L	↑	↓
R BRAKE WHL	degF	-75 to +300	M	H	L	↑	↓
FUS	degF	-75 to +300	M	H	L	↑	↓
NG UPLK	degF	-75 to +300	M	H	L	↑	↓
MFUS 1,2	degF	-75 to +300	M	H	L	↑	↓
MGL UPLK	degF	-75 to +300	M	H	L	↑	↓
R UPLK	degF	-75 to +300	M	H	L	↑	↓
FUS	degF	-75 to +300	M	H	L	↑	↓

### REMARKS

[1] An "\*" by the appropriate flight control surface actuator indicates which hydraulic system is active for the actuator. The determination is performed through comparison of active and passive/standby spool positions. Actual designation of hydraulic systems is by hydraulic system pressure.



	1										2										3										4										5																																																	
	1	2	3	4	5	6	7	8	9	0	1	2	3	4	5	6	7	8	9	0	1	2	3	4	5	6	7	8	9	0	1	2	3	4	5	6	7	8	9	0	1	2	3	4	5	6	7	8	9	0																																								
1	XXXX/XXX/088										APU/ENVIRON										THERM										XX X										DDD/HH:MM:SS																																																	
2	FREON LOOP										1										2																				DDD/HH:MM:SS																																																	
3	ACCUM QTY										XXXX										XXXX										H2O LOOP										1										2																																							
4	FREON ISOL										XXXX										XXXX										PUMP OUT P										XXXXX										XXXXX																																							
5	FREON FLOW										XXXXX										XXXXX										OUT T										XXXXX										XXXXX																																							
6	PL HX FLOW										XXXXX										XXXXX										ΔP										XXXXX										XXXXX																																							
7	AFT CP FLOW										XXXX										XXXX										ICH FLOW										XXXXX										XXXXX																																							
8	RAD IN T										XXXX										XXXX										OUT T										XXXXX										XXXXX																																							
9	RAD OUT T										XXXX										XXXX										CAB HX IN T										XXXXX										XXXXX																																							
10	EVAP OUT T										XXXX										XXXX										ACCUM QTY										XXXXX										XXXXX																																							
1	EVAP TEMP																				APU FUEL T										1										2										3																																							
2	HILD IB/OB										XXXX										XXXX										TK SURF										±XXXX										±XXXX										±XXXX																													
3	NOZ										XXXX																				TK HTR										±XXXX										±XXXX										±XXXX																													
4	TOP FWD/AFT										XXXX										XXXX										TEST LN 1										±XXXX										±XXXX										±XXXX																													
5	L/R DUCT										XXXX										XXXX										TEST LN 2										±XXXX										±XXXX										±XXXX																													
6	L/R NOZ										XXXX										XXXX										FEED LN										±XXXX										±XXXX										±XXXX																													
7	EVAP FDLN T										A										B										PUMP IN										±XXXX										±XXXX										±XXXX																													
8	FWD										XXXX										XXXX										DRN LN 1										±XXXX										±XXXX										±XXXX																													
9	MID 1										XXXX										XXXX										DRN LN 2										±XXXX										±XXXX										±XXXX																													
20	MID 2										XXXX										XXXX										OUT										±XXXX										±XXXX										±XXXX																													
1	AFT										XXXX										XXXX										BYP LN										±XXXX										±XXXX										±XXXX																													
2	TOPPING										XXXX										XXXX										GG SPLY LN										±XXXX										±XXXX										±XXXX																													
3	ACCUM										XXXX										XXXX																																																																					
4	HI LOAD										XXXX										XXXX										H2O LN INJ										±XXXX										±XXXX										±XXXX																													
5																																																																																										
6																																																																																										

The APU/ENVIRON THERM display is an SM display (DISP 88) available in SM OPS 2 and 4 which provides data on auxiliary power units and the active thermal control system.

PARAMETER CHARACTERISTICS

CRT NAME	UNITS	DISPLAYED RANGE	STATUS INDICATORS				
			M	H	L	↑	↓
FREON LOOP: ACCUM QTY	percent	0 to 100	M	H	L	↑	↓
FREON ISOL	text	ISOL or RAD	M				
FREON FLOW	lbm/hr	730 to 2700	M	H	L		↓
PL HX FLOW	lbm/hr	199 to 1300	M	H	L		↓
AFT CP FLOW	lbm/hr	0 to 500	M	H	L		↓
RAD IN T	degF	0 to 160	M	H	L		↓
OUT T	degF	25 to 130	M	H	L		↓
EVAP OUT T	degF	25 to 130	M	H	L	↑	↓
EVAP TEMP: HI LOAD INBD	degF	0 to 400	M	H	L	↑	↓
OUTBD	degF	0 to 400	M	H	L	↑	↓
TOPPING FWD	degF	0 to 400	M	H	L	↑	↓
AFT	degF	0 to 400	M	H	L	↑	↓
L	degF	0 to 250	M	H	L	↑	↓
R	degF	0 to 250	M	H	L	↑	↓
EVAP FDLN T FWD	degF	0 to 160	M	H	L	↑	↓
MID 1	degF	0 to 160	M	H	L	↑	↓
2	degF	0 to 160	M	H	L	↑	↓
AFT	degF	0 to 160	M	H	L	↑	↓
TOPPING	degF	0 to 160	M	H	L	↑	↓
ACCUM	degF	0 to 160	M	H	L	↑	↓
HI LOAD	degF	0 to 250	M	H	L	↑	↓
H2O LOOP: PUMP OUT P	psia	0 to 150	M	H	L	↑	↓
T	degF	32 to 122	M	H	L	↑	↓
ΔP	psid	0 to 60	M	H	L	↑	↓
ICH FLOW	lbm/hr	0 to 17100	M	H	L	↑	↓
OUT T	degF	20 to 70	M	H	L		↓
CAB HX IN T	degF	32 to 122	M	H	L	↑	↓
ACCUM QTY	percent	0 to 100	M	H	L	↑	↓

APU/ENVIRON THERM (Cont):

PARAMETER CHARACTERISTICS (Cont):

CRT NAME	UNITS	DISPLAYED RANGE	STATUS INDICATORS					
			M	H	L	↑	↓	
APU FUEL T: TK SURF	degF	0 to 160	M	H	L	↑	↓	
HTR	degF	0 to 160	M	H	L	↑	↓	
TEST LN 1,2	degF	0 to 250	M	H	L	↑↑	↓↓	
FEED LN	degF	0 to 250	M	H	L	↑↑	↓↓	
PUMP IN	degF	0 to 250	M	H	L	↑↑	↓↓	
DRN LN 1,2	degF	0 to 250	M	H	L	↑↑	↓↓	
OUT	degF	0 to 250	M	H	L	↑↑	↓↓	
BYP LN	degF	0 to 400	M	H	L	↑↑	↓↓	
GG SPLY LN	degF	0 to 450	M	H	L	↑↑	↓↓	
H2O LN INJ	degF	-75 to +300	M	H	L	↑↑	↓↓	

REMARKS

- [1] The Freon ISOL parameter is necessary for assessment of the radiator isolation valve configuration. It displays ISOL when the valve is closed, RAD when the valve is open, or blank in transit.

	1									2									3									4									5								
	1	2	3	4	5	6	7	8	9	1	2	3	4	5	6	7	8	9	1	2	3	4	5	6	7	8	9	1	2	3	4	5	6	7	8	9	1	2	3	4	5	6	7	8	9
1	XXXX/XXX/089									PRPLT THERMAL									XX X									DDD/HH:MM:SS																	
2	POD L R																											DDD/HH:MM:SS																	
3	OMS TK OX XXXS XXXS																		OMS CRSFD L R C																										
4										FU XXXS XXXS									XFD OX XXXS XXXS XXXS																										
5	ENG I/F OX XXXS XXXS																		GMBL LN XXXS XXXS																										
6										FU XXXS XXXS									DRN OX XXXS XXXS																										
7	OX VLV XXXS XXXS																																												
8	FU INJ XXXS XXXS																																												
9																																													
10	WEB KEEL 1 XXXS XXXS																																												
1										2 XXXS XXXS																																			
2	Y OB XXXS XXXS																																												
3										UP XXXS XXXS																																			
4	OX DRN PNL 1 XXXS XXXS																		FWD RCS FU OX																										
5										2 XXXS XXXS									LINE T1 XXXS XXXS																										
6	ENG COVER XXXS XXXS																		T2 XXXS XXXS																										
7	SERV PNL XXXS XXXS																																												
8	GSE SERV PNL XXXS XXXS																																												
9	TEST HE/OX 1 XXXS XXXS																		AFT RCS L R																										
20										2 XXXS XXXS									MANF 1 OX XXXS XXXS																										
1																			DRN PNL 1 XXXS XXXS																										
2																			2 XXXS XXXS																										
3																			VERN PNL 1 XXXS XXXS																										
4																			2 XXXS XXXS																										
5																																													
6																												(XX)																	

The PRPLT THERMAL display is an SM display (DISP 89) available in SM OPS 2 and 4 which provides data on the thermal characteristics of the OMS and RCS propellant subsystems.

PARAMETER CHARACTERISTICS

CRT NAME	UNITS	DISPLAYED RANGE	STATUS INDICATORS				
			M	H	L	↑	↓
POD: OMS TK OX	degF	0 to 160	M	H	L	↑	↓
FU	degF	0 to 160	M	H	L	↑	↓
ENG I/F OX	degF	0 to 160	M	H	L	↑	↓
FU	degF	0 to 160	M	H	L	↑	↓
OX VLV	degF	0 to 160	M	H	L	↑	↓
FU INJ	degF	-75 to +300	M	H	L	↑	↓
WEB KEEL 1	degF	0 to 160	M	H	L	↑	↓
2	degF	-75 to +175	M	H	L	↑	↓
Y OB	degF	0 to 160	M	H	L	↑	↓
UP	degF	0 to 160	M	H	L	↑	↓
OX DRN PNL 1	degF	0 to 160	M	H	L	↑	↓
2	degF	0 to 160	M	H	L	↑	↓
ENG COVER	degF	0 to 160	M	H	L	↑	↓
SERV PNL	degF	0 to 160	M	H	L	↑	↓
GSE SERV PNL	degF	0 to 250	M	H	L	↑	↓
TEST HE/OX 1	degF	-75 to +175	M	H	L	↑	↓
2	degF	-75 to +175	M	H	L	↑	↓
OMS CRSFD: XFD OX	degF	0 to 160	M	H	L	↑	↓
GMBL LN	degF	0 to 160	M	H	L	↑	↓
DRN OX	degF	0 to 160	M	H	L	↑	↓
FWD RCS: LINE T1	degF	0 to 160	M	H	L	↑	↓
T2	degF	0 to 160	M	H	L	↑	↓
AFT RCS: MANF 1 OX	degF	0 to 160	M	H	L	↑	↓
DRN PNL 1	degF	0 to 160	M	H	L	↑	↓
2	degF	-75 to +175	M	H	L	↑	↓
VERN PNL 1	degF	0 to 160	M	H	L	↑	↓
2	degF	0 to 250	M	H	L	↑	↓

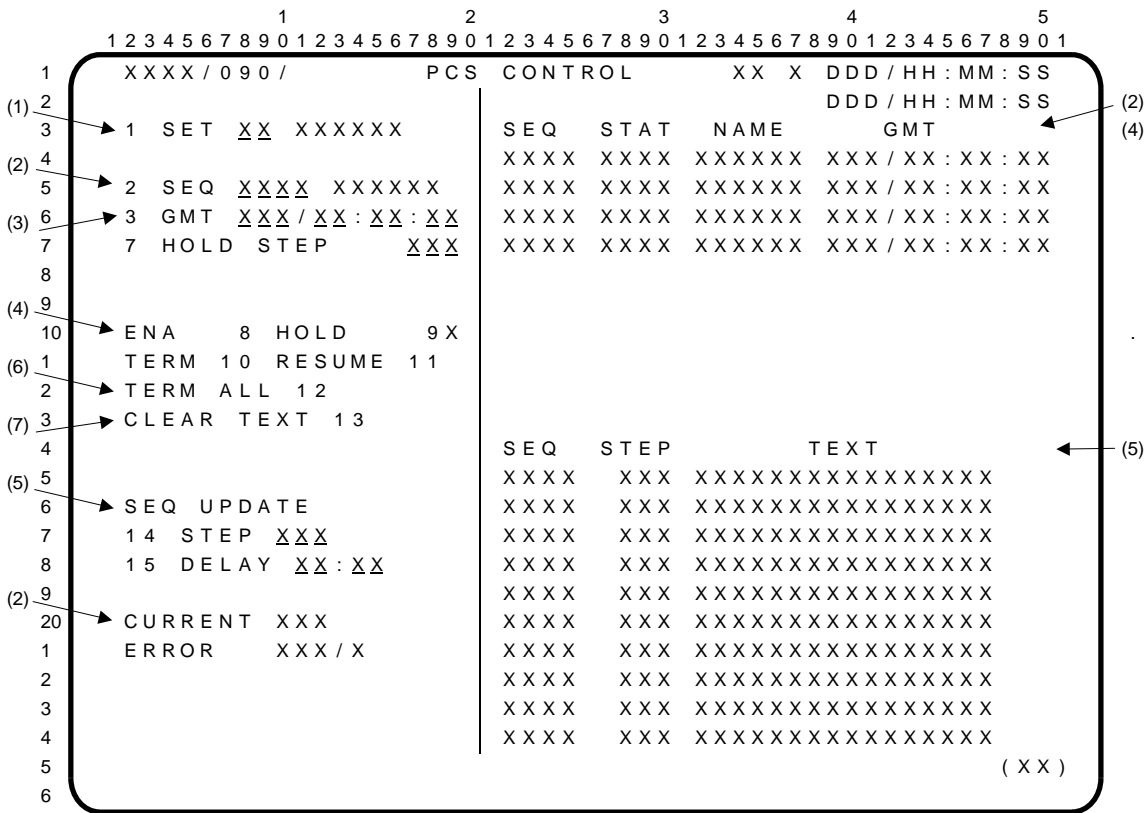

The PCS CONTROL display is a specialist function (SPEC 90) available in SM OPS 2 and 4. It supports the transfer of Payload Control Supervisor (PCS) sequence sets from mass memory and provides for control and monitoring of up to four PCS sequences at one time.

- (1) The numeric ID and name of the PCS sequence SET currently in main (GPC) memory is shown next to item 1. If a different set ID is entered via item 1, the current set name blanks when mass memory read starts and the new set name appears when it is in memory and available for use. This set will remain memory resident until a different set is requested or until a memory reconfiguration occurs. If the mass memory read is unsuccessful, the set name will remain blank. An item 1 selection will be rejected and an 'ILLEGAL ENTRY' message will appear if the selected set is not in mass memory, if the entry is made while a sequence load is in progress, or when any PCS sequence has been selected but has not completed execution. If only one set is defined for a mission, it will be brought into GPC memory with the SM overlay and item 1 is nonfunctional.
- (2) Item 2 allows selection of a sequence for subsequent keyboard control. Initially, a sequence value of 1 thru 99 is used and it becomes one of up to four sequences that can be selected at one time. Each sequence remains in the stack of four until it has completed execution or is canceled. If the value entered is not equal to any sequence ID for the set that is currently in memory or if four sequences are already selected, the entry will be rejected and an 'ILLEGAL ENTRY' message will be generated. For each valid sequence ID selection, the GPC assigns a CNTL identifier which is based on the selected sequence ID and the selection counter status. If sequence 25 is selected (item 2 +25) twice, for instance, the CNTL identifier will be 2501 for the first selection, 2502 for the second. Once a CNTL identifier is assigned, all four digits must be entered in item 2 to select a specific 'copy' of the sequence for control or editing (i.e., item 2 +2501). The selection counter is initialized at 01 for all sequences in a set, has a range of 01 to 99, and is reset to 01 after reaching 99. A valid entry will cause the CNTL identifier, NAME, and default time (GMT) to be written in the table in the upper right portion of the display. The current step number for the selected sequence is shown in the lower left portion of the display (next to CURRENT). If the sequence is in an error state, an error step number and error code will be displayed next to ERROR, just beneath the CURRENT data field.

## PCS CONTROL (Cont):

**(3)** Items 3 thru 7 provide the capability to modify default values of GMT start time (items 3 thru 6) and optional HOLD STEP (item 7) for any sequence which has been selected for control but is not enabled. Each item number is entered along with the new value for the parameter. The changes apply only to the specific copy of the sequence selected for control at the time. Default values apply for subsequent selections of item 2. Item 3 thru 7 selections will be rejected and cause an 'ILLEGAL ENTRY' message(s) to be generated if no sequence is selected, if the sequence selected is already enabled, if the value entered for the hold step does not match any steps in the sequence, if the HOLD STEP value does not correspond with the predefined legal hold step in the sequence, or if the values entered for the GMT exceed the following ranges: Days 00-400, Hours 00-24, Minutes 00-60, and Seconds 00-60.

**(4)** Items 8 thru 11 are used to alter the activity status of the sequence selected for control. The current status is indicated below STAT as: 'blank' (unenabled), 'ENA' (inactive), 'ACT' (active), 'EXCP' (exception), 'HOLD' (hold), 'TERM' (terminate), 'ERR' (error), or 'SSPD' (suspended). Any attempt to select items 8 thru 11 while a TERM ALL (item 12) request is executing will be rejected and an 'ILLEGAL ENTRY' message will be generated.

If the controlled sequence is unenabled, an item 8 (ENA) entry will make it eligible for execution and cause the activity status (STAT), and the selected start time (GMT) to appear in the upper right portion of the display. When the last step of the sequence is executed (or the sequence is canceled), the data in the upper right section of the display for that sequence will be blanked. If the controlled sequence is in any state other than unenabled, an 'ILLEGAL ENTRY' message will be generated and the sequence will be unaffected by an item 8 entry.

If the controlled sequence is in the active or exception state, an item 9 (HOLD) entry will place it in the hold state at the next legal hold step. If the sequence is already in hold, the hold request will take effect after an item 11 (RESUME) entry. An '\*' next to item 9 indicates that a hold request is pending. The '\*' is blanked when the sequence goes to the hold or error state, or upon item 10 (TERM), item 12 (TERM ALL), or OPS transition request. If the controlled sequence is not in the active, exception, or hold state when an item 9 request is made, the entry will be rejected and an 'ILLEGAL ENTRY' message will be generated.

An item 10 (TERM) entry will initiate cancel processing if the controlled sequence is in the active, exception, or hold state. If in the unenabled, inactive, or suspended state, all display items for the sequence will be cleared and the sequence will be deselected. If in the terminate state, the entry will be rejected.

If the controlled sequence is in the hold state, an item 11 (RESUME) entry will place it in the active state and begin execution with the step identified as the CURRENT step. If the controlled sequence is in any other state, the entry will be rejected and an 'ILLEGAL ENTRY' message will be generated.

A controlled sequence in the active, exception, or terminate state will be placed in the error state ('ERR' is driven in STAT column) when an error condition is encountered, provided that safing steps have been defined. The sequence remains in the error state until the last step is executed or a second error is encountered, at which time it is placed in the suspend state ('SSPD' is driven in STAT column). A controlled sequence without a safing step defined, but in the active, exception, or terminate state, will be placed in the suspend state when the first error occurs. A sequence in the inactive state will be placed in suspend if a different selection of the same sequence is in any state except unenabled, inactive, or suspend when transfer from inactive to active is attempted. It will remain in the suspend state until a sequence cancel request is processed or an OPS transition occurs.

**(5)** Any sequence that is selected and not enabled is eligible for updating as long as the two left-most characters of the selected sequence do not match those of another sequence which is enabled. Note: Sequence updates affect main memory; and therefore, apply to all subsequent selections of the sequence unless/until a 'clean' version is forced/selected from the MMU. If a SEQ UPDATE STEP number (item 14) is received and the currently selected sequence is ineligible for updating, or the entered value does not match the step number of a DELAY operator in the selected sequence, the entry will be rejected and an 'ILLEGAL ENTRY' message will be generated. Receipt of a valid STEP entry will make the appropriate DELAY operator available for editing via subsequent item entry.

PCS CONTROL (Cont):

If the update step is a DELAY, the delay time contained in the operator will appear next to DELAY (item 15). The DELAY time is edited using items 15 and 16 which represent minutes and seconds, respectively. Items 15 and 16 entries will be rejected and an 'ILLEGAL ENTRY' message will be generated if no update step is selected, if the step being updated is not a DELAY OPR, or if the entered data for each item is outside the range 00-59.

- (6) Item 12 (TERM ALL) entries initiate cancel processing for all selected sequences and clear all display items for the terminated sequences.
- (7) The lower right portion of the display shows TEXT messages from the 10 most recently processed TEXT OPRs. The step number of the OPR and the CNTL ID of the sequence containing the OPR is included with each message. The TEXT message stack is blanked upon OPS initialization and via item 13 (CLEAR TEXT).

```

1 2 3 4 5 6 7 8 9 0 1 2 3 4 5 6 7 8 9 0 1 2 3 4 5 6 7 8 9 0 1 2 3 4 5 6 7 8 9 0 1
1  XXXX/094/XXX          PDRS CONTROL          XX X DDD/HH:MM:SS
2                                     DDD/HH:MM:SS
3  RMS SEL: XXXX          RMS PWR XXX          ENA INH
4    PORT 1X          34 RMS S/N XXX          SOFT STOP 7X 8X
5    STBD 2X          I/O ON 5X          AUTO BRAKE 9X 10X
6    3 PL ID XX          OFF 6X          POS ENC CK 11X 12X
7    4 END EFF X          POHS CNTL 28X 29X
8
9          AUTO MODES
10         1          2          3          4          17 START PT XXX
11        13 XX          14 XX          15 XX          16 XX          LAST PT XXX
12
13          OPR CMD MODES / POR REF
14  END POS          END ATT          24 PL INIT ID  XX
15  18 X [±]XXXX.XX  21 P [±]XXX.XX
16  19 Y [±]XXXX.XX  22 Y [±]XXX.XX  CMD CK 25 XXXX
17  20 Z [±]XXXX.XX  23 R [±]XXX.XX
18
19          POR DISPLAY 30 XXX
20
21  XXXX  STO/DPLY
22  MPM   X X X X
23
24          ORB LD CMD REF
25  NORM  FLY-CAMR  FLY-PL
26  31X   32X   33X
27
28          LAT/REL/RDY
29  AFT X X X X X X
30  MID X X X X X X          26 WR RANGE X
31  FWD X X X X X X          AUTO BRAKE CK 27X
32
33
34
35
36
37
38
39
40
41
42
43
44
45
46
47
48
49
50
51
52
53
54
55
56
57
58
59
60
61
62
63
64
65
66
67
68
69
70
71
72
73
74
75
76
77
78
79
80
81
82
83
84
85
86
87
88
89
90
91
92
93
94
95
96
97
98
99
100

```

The PDRS CONTROL display is an SM specialist function (SPEC 94) available in SM OPS 2 and 4 which is used to input RMS and payload initialization data; initiate communication between SM GPC and RMS MCIU; input and monitor RMS auto sequence data; enable and inhibit certain GPC controlled system checks and safety features; monitor the state of RMS or OBSS rollout and retention latches; and monitor the end effector operation feedback parameters.

PARAMETER CHARACTERISTICS

CRT NAME	UNITS	DISPLAYED RANGE	STATUS INDICATORS					
			M	H	L	↑	↓	
RMS SEL	[1]	text	See Remarks					
PWR	[2]	text	See Remarks					
PL ID	[3]	text	0-5					
END EFF	[4]	text	1,2					
RMS S/N	[5]	text	See Remarks					
AUTO MODES (1-4)	[6]	text	1-20					
START PT	[7]	text	1-199					
LAST PT	[8]	inches	1-200					
END POS	[9]	degrees						
ATT	[10]	text	See Remarks					
PL INIT ID	[11]	text	0-5					
CMD CK	[12]	text	See Remarks					
WR RANGE	[13]		1-6					
PORT/STBD STO/DPLY	[14]							
MPM			1,0					
LAT/REL/RDY	[15]							
AFT			1,0					
MID			1,0					
FWD		text	1,0					
POR DISPLAY	[16]		See Remarks					

PDRS CONTROL (Cont):

REMARKS

- [1] 'PORT', 'STBD', or 'OFF' to indicate the RMS selected for use. Field is blank when in SUSPEND mode (i.e., I/O OFF).
- [2] 'PRI', 'OFF', 'B/U' indicates position of the RMS POWER switch.
- [3] Payload identifications are 0 (unloaded arm) thru 5 (specific points of resolution).
- [4] End effectors are identified as 1 and 2.
- [5] The serial number of the arm currently selected for initialization via Item 1 (port) or Item 2 (starboard) will be cyclically displayed. Valid serial number selections for this item are 201, 202, 301, and 303. For input of any value other than these, the input value will be rejected. The input value will be rejected if the serial number is entered while the RMS software is in a configuration other than the Suspend or the Temperature Monitor configuration.
- [6] Up to 20 automatic sequences may be stored in main memory. Numerical fields indicate auto sequence assigned to AUTO 1(2,3,4) position of MODE select switch.
- [7] Identifies start point of the auto sequence item 13(14,15,16) selected via AUTO 1(2,3,4) position of MODE select switch. When AUTO 1 thru 4 entered, start point is initialized to first point in that sequence. Any other point (1-199) in that sequence may be selected via item 17.
- [8] Identifies last point achieved by auto sequence selected via AUTO 1(2,3,4) position of MODE select switch. Updates as point of resolution achieves sequence pause point, intercept sequence flyby point, or reaches sequence final point.
- [9] Inputs of desired operator commanded auto sequence end point position in inches with respect to RMS orbiter body axis coordinates.
- [10] Inputs of desired operator commanded auto sequence end point Euler attitude in degrees with respect to RMS orbiter rotational axis coordinates. Pitch of 0.00-359.99 degrees; yaw of 0.00-90.00 degrees and 270.00-359.99 degrees; and roll of 0.00-359.99 degrees.
- [11] Payload INIT ID inputs of 0 (unloaded arm) through 5 (specific points of resolution).
- [12] If the end point is within RMS reach capability, 'GOOD' is displayed when item 25 is executed. If not, 'FAIL' is displayed. Field is initialized blank and is reblanked when any of items 18 thru 24 are executed.

NOTE: A 'GOOD' indication does not verify a safe trajectory.

- [13] Inputs of 1 to 6 correspond to wrist roll angles:

<u>Input</u>	<u>WR ANGLE (in degrees)</u>
1	-450 to -360
2	-360 to -180
3	-180 to 0
4	0 to +180
5	+180 to +360
6	+360 to +450

- [14] Discretes indicating PORT or STBD shoulder mechanism position (stowed or deployed). A toggle between Item 1 and 2 determines whether Port or Stbd MPM and MRL indications are displayed.
- [15] Discretes indicating the Aft, Mid, and Fwd retention latches are in the latched (LAT), released (REL), or ready-to-latch (RDY) position. A toggle between Item 1 and 2 determines whether Port or Stbd MPM and MRL indications are displayed.
- [16] Indicates Point of Resolution (POR) for current coordinate system: either the orbiter body axis system (ORB), or a system defined by items 18 thru 23 (REL).



PDRS CONTROL (Cont):

ITEM ENTRY CHARACTERISTICS (Cont):

ITEMS 1 and 2	Select PORT or STBD arm to be initialized. Display is initialized with PORT selected (* shows selection). Selection can not be changed once item 32 (FLY-CAMR) or item 33 (FLY-PL) is selected. These item entries also determine which MPM and MRL indications (Port or Stbd) will be displayed.
ITEM 3	Selects the PL ID defining the point of resolution of the payload to be handled by the arm selected by item 1 or 2. PL ID will be zero when display is initialized. Selection cannot be changed once item 32 (FLY-CAMR) or item 33 (FLY-PL) is selected.
ITEM 4	Selects the ID of the end effector to be used. Display initialized with 1 selected.
ITEMS 5 and 6	Turn ON/OFF the input/output (I/O) between GPC and MCIU. Display initialized with item 6 (OFF) selected (* shows selection).
ITEMS 7 and 8	Enable/inhibit the soft stop. Display initialized with item 7 (ENA) selected (* shows selection).
ITEMS 9 and 10	Enable/inhibit the auto brake function of the consistency check. Display initialized with item 9 (ENA) selected (* shows selection).
ITEMS 11 and 12	Enable/inhibit the position encoder check. Display initialized with item 11 (ENA) selected (* shows selection).
ITEMS 13 thru 16	Provide assignment of a preprogrammed auto sequence to switch positions AUTO 1(2,3,4) of the MODE select switch. Display initialized with items 13, 14, 15, 16 blanked.
ITEM 17	START PT designates the prestored point in the selected auto sequence, which is to be used as the starting point. LAST PT shows the last intercept point that has been achieved by the point of resolution during the auto sequence (this may be a pause point, flyby point, or the final sequence point). Both the START PT and LAST PT values are initialized blank.
ITEMS 18, 19, 20	Provide selection of the point of resolution final position for the operator commanded auto sequences. Also specify the referenced X, Y, and Z positions when item 30 (POR REF SEL) is in REL. Selection cannot be changed once item 32 (FLY-CAMR) or item 33 (FLY-PL) is selected. END POS X, Y, Z are blank when display is initialized and when arm is selected.
ITEMS 21, 22, 23	Provide selection of the point of resolution Euler rotational attitude for the operator commanded auto sequences. Also specify referenced pitch, yaw and roll when item 30 (POR REF SEL) is in 'REL', and the orientation of the command frame when items 32 (FLY-CAMR) or 33 (FLY-PL) are active. Selection cannot be changed once item 32 (FLY-CAMR) or item 33 (FLY-PL) is selected. END ATT P, Y, R are blank when display is initialized and when arm is selected.
ITEM 24	Used with items 18 thru 23 to provide selection of the point of resolution for the operator commanded auto sequences. Display initialized with '0' selected. For valid entry into operator commanded auto mode, item 24 must match item 3. Selection cannot be changed once item 32 (FLY-CAMR) or item 33 (FLY-PL) is selected.
ITEM 25	Provides a check of the end point specified by items 18 thru 24 to verify it is within RMS reach capability. Item 25 is initialized blank and is blanked when an arm is selected or when any one of items 18 thru 23 is changed. Item 25 can not be performed once item 32 (FLY-CAMR) or item 33 (FLY-PL) is selected.

PDRS CONTROL (Cont):

ITEM ENTRY CHARACTERISTICS (Cont):

- ITEM 26 Provides capability to update the wrist roll range. Item 26 initialized at 4.
- If a WR RANGE of 1 or 6 is entered while the WR encoder ANGLE is greater than or equal to 90 degrees and less than 270, the item entry will be rejected with an 'ILLEGAL ENTRY' error message.
- ITEM 27 Used to verify that the auto brake circuitry will apply the brake, independent of the consistency check. An '\*' indicates selection. To reset the auto brakes, the brake switch on panel A8U must be cycled ON, then OFF. The brake switch should be OFF while performing this check.
- ITEMS 28, 29 Provide capability to enable or inhibit the Position Orientation Hold Select (POHS) controller. The POHS reduces steady-state uncommanded motion for nondriven axes. These items are mutually exclusive; an '\*' is driven next to the item currently selected. When SPEC 94 is first called, the POHS controller will be ON ('ENA 28 \*').
- ITEM 30 Provides capability to display the Point of Resolution (POR) in the orbiter body axis system for positions, and in the orbiter rotation axis system for attitudes, or relative to a position and attitude which is specified in items 18 thru 23. Executing item 30 will toggle the POR between the orbiter coordinate system (ORB) and the relative coordinate system (REL). When SPEC 94 is first called, the POR will be in ORB.
- ITEMS 31, 32, 33 Operation:
- Used to select one of three types of hand controller responses. Item 31 (NORM) selects the normal mode of operation. If item 33 (FLY-PL) is selected, the direction of RMS controller commands will be associated with the "fly-payload" axis system defined by the information contained in items 18 thru 23. If item 32 (FLY-CAMR) is selected, the direction of RHC and THC commands will be the opposite of the "fly-payload" axis system. An '\*' indicates an item has been selected.
- Conditions:
- Items 31, 32, and 33 are mutually exclusive
- In order to select either item 32 or 33:
1. Item 25 (CMD CK) must be 'GOOD'
  2. Item 3 (PL ID) must be the same as item 24 (PL INIT ID)
  3. The orbiter loaded mode must be selected (SPEC 95)
- If these conditions are not met, attempts to select item 32 or 33 will result in an 'ILLEGAL ENTRY' message.
- Once item 32 or 33 is selected, no change may be made to items 1 or 2 (PORT/STBD RMS), item 3 (PL ID), items 18 thru 20 (END POS), items 21 thru 23 (END ATT), or item 24 (PL INIT ID); nor may item 25 (CMD CK) be performed. Attempts to execute any of these items while item 32 or 33 is selected will result in an 'ILLEGAL ENTRY' message.

PDRS CONTROL (Cont):

ITEM ENTRY CHARACTERISTICS (Cont):

Initialization:

While not in manual augmented orbiter loaded mode, items 31, 32, and 33 shall be blank.

Upon entering manual augmented orbiter loaded mode, item 31 (NORM) will be selected.

ITEM 34

Provides capability to specify a particular RMS serial number. The serial number entered by this item is assigned to the arm (port or starboard) currently selected for initialization. The serial number selected drives the joint angle biases for the arm. The default values of the serial numbers for both the port and starboard arms are initialized external to this RMS CNTL process.

This Page Intentionally Blank

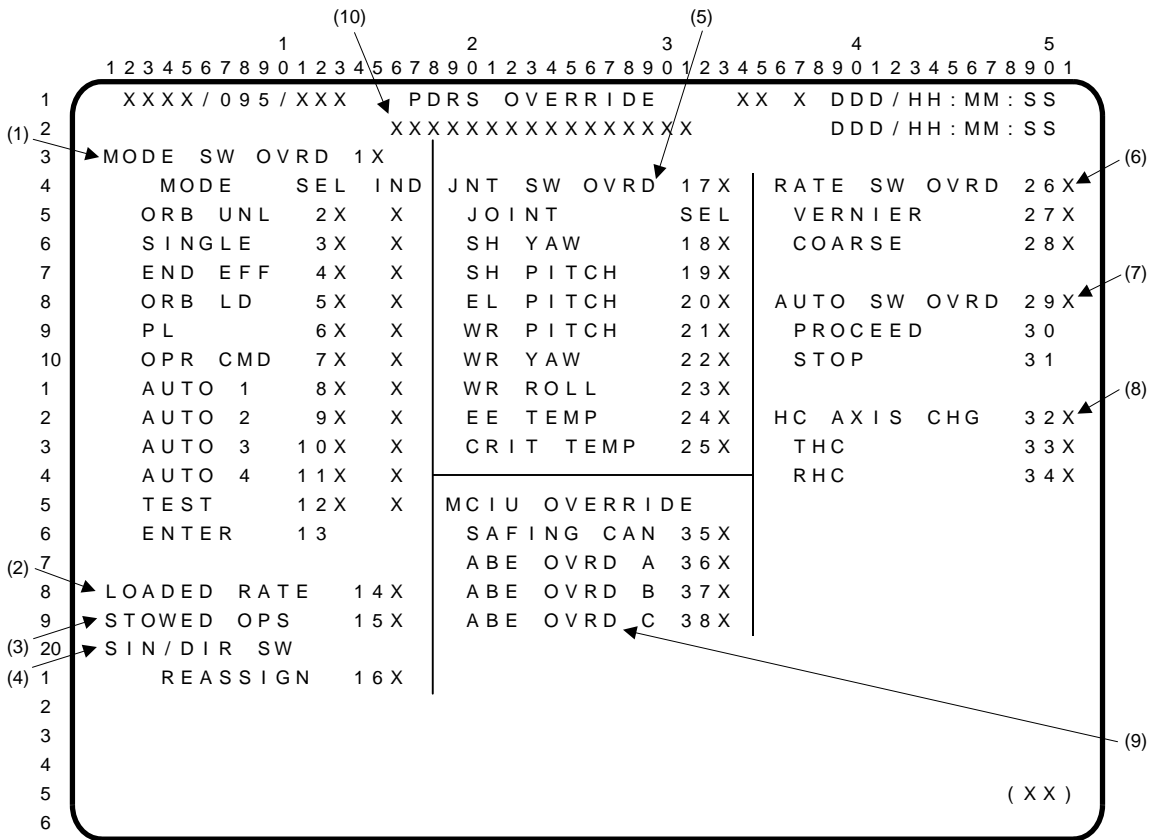

The PDRS OVERRIDE display is a specialist function (SPEC 95) available in SM OPS 2 and 4 which provides the following capabilities: override a number of RMS switch inputs in the event a major switch fails; toggle the loaded rate limit flag; and configure the RMS software for correct operation in the MPM stowed position.

**(1) MODE SW OVRD.** Item 1 provides the capability to override the RMS Mode Select switch and the Mode Enter pushbutton, both of which are located on panel A8U. The display is initialized with item 1 deselected (no '\*'). Items 2 thru 12 (mode select) and item 13 (mode enter) cannot be executed while item 1 is deselected. An '\*' will still be displayed by the appropriate mode select item to reflect the actual hardware switch position. Likewise, the data in the IND columns will mimic the mode selected indicator lights on panel A8U.

Once item 1 is selected, the hardware inputs are ignored. Items 2 thru 12, which are mutually exclusive, are used to select the desired mode. Item 13 is used to enter the selected mode. An 'ILLEGAL ENTRY' message will result if item 13 is executed with none of items 2 thru 12 selected.

**(2) LOADED RATE.** Execution of item 14 toggles the value of the loaded rate limit flag. It is initialized off (no '\*').

**(3) STOWED OPS.** The crew can enable or disable the RMS stowed operations via ITEM 15. The display is initialized with item 15 deselected (no '\*'). When item 15 is executed, the RMS software uses a different set of arm position constants (for the attach points and swingout angle) to calculate the appropriate arm position parameters.

**(4) SIN/DIR SW REASSIGN.** Item 16 reassigns the Single/Direct Drive switch function to the Auto Sequence Stop/Proceed switch; both of these switches are located on panel A8U. The display is initialized with item 16 deselected (no '\*'). Attempting to execute item 16 while AUTO SW OVERRIDE (item 29) has been selected will result in an 'ILLEGAL ENTRY' message.

**(5) JNT SW OVRD.** Item 17 can be used to override the RMS Joint Select switch on panel A8U. The display is initialized with item 17 deselected (no '\*'). Items 18 thru 25 (joint select) are inhibited if item 17 is deselected. An '\*' will still be driven next to the appropriate joint select item to reflect the actual switch position. Attempting to execute any of items 18 thru 25 with item 17 deselected will result in an 'ILLEGAL ENTRY' message.

## PDRS OVERRIDE (Cont):

Once item 17 is selected, hardware inputs from the RMS Joint Select switch are ignored in favor of items 18 thru 25. These items which are mutually exclusive are used to select the desired joint.

- (6) RATE SW OVRD. Item 26 provides the capability to override the RMS RATE Select switch located on the RHC. The display is initialized with item 26 deselected (no '\*'). Items 27 and 28 are inhibited as long as item 26 remains deselected. An '\*' will still appear next to either the VERNIER item or COARSE item depending on the actual position of the hardware switch. An 'ILLEGAL ENTRY' message will result if item 27 or 28 is executed without item 26 being selected first.

Selecting item 26 will override the hardware inputs from the switch; item 27 (VERNIER) and item 28 (COARSE), which are mutually exclusive, will be used to select the rate.

- (7) AUTO SW OVRD. Item 29 can be used to override the RMS Autosequence Stop Proceed switch on panel A8U. The display is initialized with item 29 deselected (no '\*'). With item 29 deselected, both items 30 and 31 are inhibited; an '\*' will still appear next to the appropriate item depending on the actual switch position. Attempting to execute items 30 and 31 without first selecting item 29 will result in an 'ILLEGAL ENTRY' message.

With item 29 selected, the switch hardware inputs will be ignored and replaced by the auto select items.

- (8) HC AXIS CHG. Item 32 changes the sense of the translational or rotational hand controller. The display is initialized with items 32 thru 34 deselected (no '\*'). As long as item 32 remains deselected, both items 33 and 34 are inhibited. Execution of item 33 (THC) reassigns the THC inputs such that X becomes Y, Y becomes Z, and Z becomes X. Execution of item 34 changes the RHC inputs so that pitch becomes yaw, yaw becomes roll, and roll becomes pitch. Reexecution of these items restores the original sense.

- (9) MCIU OVERRIDE. Items 35 thru 38 provide the capability to override various MCIU-detected failures that result in loss of GPC-supported RMS modes due to autobrake application. Each item toggles its associated Arm Based Electronics (ABE) unit override between ON and OFF. When an override is ON, an '\*' will appear next to its item number; when that override is OFF, the '\*' is blanked. Each override is initialized in the OFF state when SM software is uploaded from Mass Memory.

- (10) This field reads 'INPUTS INHIBITED' double-overbright when RMS software is not executing; it is blank at all other times.

```

1 2 3 4 5 6 7 8 9 0 1 2 3 4 5 6 7 8 9 0 1 2 3 4 5 6 7 8 9 0 1 2 3 4 5 6 7 8 9 0 1
1 XXXX/096/XXX PDRS FAULTS XX X DDD/HH:MM:SS
2 DDD/HH:MM:SS
3 ABE BITE: SY SP EP WP WY WR
4 MDA OVERCURRENT/ MCIU:
5 MOTOR DRV FAULT MADC X
6 COMMUTATOR X X X X X X MCPC X
7 TACHOMETER X X X X X X ICF X
8 TOTAL COMPENSATOR X X X X X X
9 MICROCOMPUTER X X X X X X ABE:
10 MDA DEMAND VOLTAGE X X X X X X COMM X
1 A/D CONVERTER X X X X X X
2 BRAKE X X X X X X CHECK CRT:
3 POS ENCODER X X X X X X DC/MCIU X
4 BACKUP RELAY X X X X X X EXT FS X
5 CHECK CRT: EE FLAG X
6 DIRECT DRIVE BITE X X X X X X EEU X
7 POS ENCODER X X X X X X EE CMDS X
8 CONTR ERROR X X X X X X HC X
9 REACH LIMIT X X X X X X MCIU HC X
20 TMP CKT X
1
2 CHECK CRT: SY SP EP WP WY WR
3 SPA BITE TEST XXXX XXXX XXXX XXXX XXXX XXXX
4
5 (XX)
6

```

The PDRS FAULTS display (DISP 96) is available in SM OPS 2 and 4. It provides data on RMS failures detected by SPA hardware. Joint-related failures can be annunciated for any of the arm's six possible degrees of freedom: shoulder yaw & pitch (SY & SP), elbow pitch (EP), and wrist pitch, yaw & roll (WP, WY & WR).

#### PARAMETER CHARACTERISTICS

CRT NAME	UNITS	DISPLAYED RANGE	STATUS INDICATORS				
			M	H	L	↑	↓
<u>ABE</u> BITE: MDA OVERCURRENT/ MOTOR DRIVE FAULT [1]							↓
COMMUTATOR							↓
TACHOMETER							↓
TOTAL COMPENSATOR							↓
MICROCOMPUTER							↓
MDA DEMAND VOLTAGE							↓
A/D CONVERTER							↓
BRAKE							↓
POS ENCODER							↓
BACKUP RELAY							↓
<u>MCIU</u> : MADC [2]							↓
MCPC							↓
ICF							↓
<u>ABE</u> : COMM [3]							↓

PDRS FAULTS (Cont):

PARAMETER CHARACTERISTICS (Cont):

CRT NAME	UNITS	DISPLAYED RANGE	STATUS INDICATORS				
			M	H	L	↑	↓
<u>CHECK CRT:</u> DC/MCIU [4]							↓
EXT FS							↓
EE FLAG							↓
EEEU							↓
EE CMDS							↓
HC							↓
MCIU HC							↓
TMP CKT							↓
<u>CHECK CRT:</u> DIRECT DRIVE BITE [5]							↓
POS ENCODER							↓
<u>CONTR ERROR</u> [6]							↓
<u>REACH LIMIT</u> [7]		See Remarks					
<u>CHECK CRT:</u> SPA BITE TEST [8]		See Remarks					

REMARKS

- [1] ABE BITE: Parameters indicate the following overcurrent failures in the Arm Based Electronics Unit: Motor Drive Amplifier overcurrent (MDA); invalid Servo Power Amplifier Commutator (COMMUTATOR) pattern; Tachometer Phase Lock Loop (TACHOMETER) out-of-lock condition; Tachometer Total Compensator Output (TOTAL COMPENSATOR) current sensor failure or miscompare between prime and redundant tacho data; Central Processing Unit (MICROCOMPUTER) watchdog timer test or hardware failure; Motor Drive Amplifier Demand (MDA DEMAND VOLTAGE) voltage BITE fail; Analog-to-Digital Converter (A/D CONVERTER) BITE fail; Brake (BRAKE) current BITE fail; Position Encoder (POS ENCODER) BITE fail; and Backup Relay (BACKUP RELAY) BITE fail.
- [2] MCIU parameters indicate the BITE status of the Manipulator Controller Interface Unit components: the Multiplexer Analog to Digital Converter (MADC); Manipulator Controller Power Conditioner (MCPC); and Interface Control Function (ICF).
- [3] ABE: COMM indicates the status of data bus communications between the ABE and the MCIU.
- [4] Illumination of the CHECK CRT light on panel A8 and a corresponding '↓' indicate one of the following: a failure in communication between panel A8A1 and the MCIU (DC/MCIU); a loss of the external frame sync (EXT FS) pulse to the ABE; an invalid microswitch combination (EE FLAG); an End Effector Electronics Unit (EEEU) failure; an out-of-tolerance end effector command (EE CMDS) from the MCIU; a failure in the Hand Controller (HC); a mismatch between the dual multiplexed hand controlled signal in the MCIU (MCIU HC); or a failure within the thermistor circuit (TMP CKT).
- [5] CHECK CRT: Parameters indicate the following failures: Direct Drive (DIRECT DRIVE BITE) BITE fail and POS (POS ENCODER) indicates that one of the joint positioning encoders has failed.
- [6] CONTR ERROR (Control Error) indicates that a joint runaway error has occurred or that joint position encoder data and tach data do not agree.
- [7] REACH LIMIT is a warning indication that a joint is near its allowable angular limit. Text output is a '+', a '-', or a blank.
- [8] CHECK CRT: SPA (Servo Power Amplifier) BITE TEST indicates the type of SPA hardware failure being announced by the SPA BITE. Text output is 'LOSS', 'FS', 'CMTR', 'O/C', 'PLL', 'CPU', 'D/D', or a blank.



	1	2	3	4	5																									
	1	2	3	4	5	6	7	8	9	0	1	2	3	4	5	6	7	8	9	0	1	2	3	4	5	6	7	8	9	0
1	XXXX/XXX/097					PL RETENTION										XX X DDD/HH:MM:SS														
2																DDD/HH:MM:SS														
3																														
4																														
5						LATCH										LATCH														
6						1										2														
7						AB/AB										AB/AB														
8	PL SEL 1					XX										XX														
9	RDY-FOR-LAT					XX										XX														
10	LAT/REL					XX/XX										XX/XX														
11																														
12	PL SEL 2					XX										XX														
13	RDY-FOR-LAT					XX										XX														
14	LAT/REL					XX/XX										XX/XX														
15																														
16	PL SEL 3					XX										XX														
17	RDY-FOR-LAT					XX										XX														
18	LAT/REL					XX/XX										XX/XX														
19																														
20																														
21																														
22																														
23																														
24																														
25																														
26																														

The PL RETENTION display is an SM display (DISP 97) available in OPS 2 and 4 which provides the microswitch status for the 15 payload retention latches. Five latches are displayed for each of the possible payload select rotary switch positions. When one position is selected, the microswitch status for the other two positions will be blanked. If none of the payload select positions is selected, the microswitch status for all 15 latches will be displayed. When a payload is latched, or when it is close enough to be latched, the 'RDY-FOR-LAT' fields display '1's and the 'REL' fields display '0's. When unlatched, the 'LAT' fields display '0's and the 'REL' fields display '1's.

	1	2	3	4	5
	1	2	3	4	5
	1	2	3	4	5
1	XXXX/XXX/167	DOCKING STATUS	XX X	DDD/HH:MM:SS	
2				DDD/HH:MM:SS	
3	CONTACT XXXS	CNTL PNL PWR XS/XS/XS	CNTL CMD PWR XXXS		
4	CAPTURE XXXS	HTR/DCU PWR XS/XS/XS	RNG DR BUS XS/XS		
5	DAMPING XXXS	APDS PWR XS/XS/XS	HKS DR BUS XS/XS		
6	RNG ALGN XXXS	APDS CIRC PROT XXXS	DAMPER BUS XS/XS		
7	RING POS XXXXS/XXXS/XXXS		FIXER BUS XS/XS		
8	DRV CMD XXXS		PMA 2/3 OP / CL		
9	FIXERS XXXS		HK1 CMD XSXS/XSXS		
10	CLUTCH XXXXS/XXXXS		IND XSXS/XSXS		
1	PETAL POS 1 2 3		HK2 CMD XSXS/XSXS		
2	RING XXXS XXXS XXXS		IND XSXS/XSXS		
3	BASE XXXS XXXS XXXS		HK CLS		
4	UNDOCK CMPLT XXXS		1/3/5 XXS 7/9/11 XXS		
5	RDY TO HOOK XXXS		2/4/6 XXS 8/10/12 XXS		
6	HK1 DRV CMD XXXS		ODS INDIV HK CL	ODS CONN	
7	POS XXXS		1 3 5 7 9 11	X3 XXXS	
8	IND XXS/XXS		XXSXXSXXSXXSXXSXXS	X4 XXXS	
9	HK2 DRV CMD XXXS				
20	POS XXXS		2 4 6 8 10 12		
1	IND XXS/XXS		XXSXXSXXSXXSXXSXXS		
2	CAP LAT CMD XXXS		PYRO LOGIC PWR XS/XS/XS		
3	IND XXS/XXS		PYRO CIRC PROT XXXS/XXXS		
4	MAN REL XXS		PYRO MNA 40/6 AMP XXXS/XXXS		
5				(XX)	
6					

The DOCKING STATUS display (DISP 167) is available in SM OPS 2. It provides data on Shuttle docking hardware. This display flies on all vehicles to keep the software load generic. For flights on which the docking hardware is not installed, all data fields will display an 'M'.

#### PARAMETER CHARACTERISTICS

CRT NAME	UNITS	DISPLAYED RANGE	STATUS INDICATORS				
			M	H	L	↑	↓
RNG ALGN		'ON' or 'OFF'	M				
CONTACT		'OFF' or 'ON'	M				
CAPTURE		'OFF' or 'ON'	M				
DAMPING		'OFF' or 'ON'	M				
CNTL PNL PWR	[1]	see Remarks	M				
HTR/DCU PWR	[1]	see Remarks	M				
APDS PWR	[1]	see Remarks	M				
CIRC PROT		'ON' or 'OFF'	M				
CNTL CMD PWR		'OFF' or 'ON'	M				
RNG DR BUS		'1/2'	M				
HKS DR BUS		'1/2'	M				
DAMPER BUS		'1/2'	M				
FIXER BUS		'1/2'	M				
RING POS	[2]	see Remarks	M				
DRV CMD		'OFF' or 'ON'	M				
FIXERS		'OFF' or 'ON'	M				
CLUTCH	[3]	see Remarks					
PETAL POS							
RING	percent	0 to 100	M				
BASE	percent	0 to 100	M				
UNDOCK CMPLT		'ON' or 'OFF'	M				
RDY TO HOOK		'OFF' or 'ON'	M				

DOCKING STATUS: (Cont)

PARAMETER CHARACTERISTICS

CRT NAME	UNITS	DISPLAYED RANGE	STATUS INDICATORS				
			M	H	L	↑	↓
HK 1 DRV CMD	percent	'OFF' or 'ON'	M				
POS		0 to 100	M				
HK 1 IND	percent	'OP/CL'	M				
2 DRV CMD		'OFF' or 'ON'	M				
POS		0 to 100	M				
IND		'OP/CL'	M				
CAP LAT CMD		'OFF' or 'ON'	M				
IND		'OP/CL'	M				
MAN REL		'OP or CL'	M				
PMA 2/3							
HK1 CMD	[4]		M				
IND	[4]		M				
HK2 CMD	[4]		M				
IND	[4]		M				
ODS INDIV HK CL			M				
1/3/5/7/9/11		blank or 'C'	M				
2/4/6/8/10/12		blank or 'C'	M				
ODS CONN			M				
X3		'OFF' or 'ON'	M				
X4		'OFF' or 'ON'	M				
PYRO LOGIC PWR	[1]	see Remarks	M				
CIRC PROT		'ON' or 'OFF'	M				
MNA 40 AMP		'ON' or 'OFF'	M				
6 AMP		'ON' or 'OFF'	M				

REMARKS

- [1] CNTL PNL PWR, HTR/DCU PWR, APDS PWR and HOOK PYRO LOGIC POWER each have three data fields, represented above as 'X/X/X'. These three fields will display 'A/B/C' if all three buses are supplying power to the systems indicated. If a bus is not supplying power, its associated field will be blanked.
- [2] RING POS data fields read, from left to right, 'INIT' or blank, 'FWD' or blank, and 'FNL' or blank.
- [3] CLUTCH: Left data field will read 'SLIP' or blank; right data field will read 'LOCK' or blank, depending on status of clutch.
- [4] PMA 2/3 HK1/2 CMD/IND – Both the 'OP' and 'CL' columns contain two sub-columns of data fields each. The left sub-column shows the position of Hook Group 1 and will display either '1' or a blank. The right sub-column shows the position of Hook Group 2 and will display either '2' or a blank.

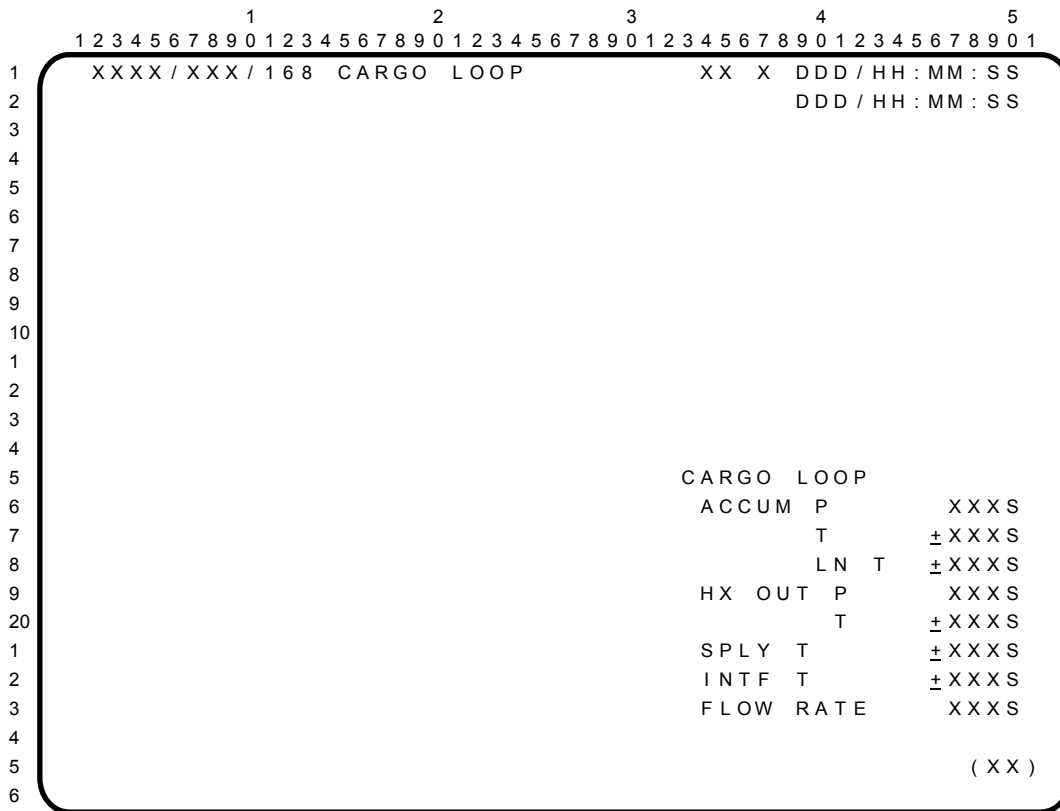

The CARGO LOOP display is an SM display (DISP 168) available in SM OPS 2 and 4 and in BFS SM OPS 0 which provides detailed status information on the Cargo Cooling Loop.

**PARAMETER CHARACTERISTICS**

CRT NAME	UNITS	DISPLAYED RANGE	STATUS INDICATORS				
			M	H	L	↑	↓
CARGO LOOP: ACCUM P	[1] psia	0 to 250	M	H	L	↑	↓
ACCUM T	[1] degF	0 to 250	M	H	L	↑	↓
ACCUM LN T	[1] degF	0 to 250	M	H	L	↑	↓
HX OUT P	[1] psia	0 to 267	M	H	L	↑	↓
HX OUT T	[1] degF	0 to 250	M	H	L	↑	↓
SPLY T	[1][2] degF	0 to 250	M	H	L	↑	↓
INTF T	[1][2] degF	0 to 250	M	H	L	↑	↓
FLOW RATE	[1][2] lbm/hr	160 to 800	M	H	L	↑	↓

**REMARKS**

- [1] These parameters are only present on the display for OV-103 and OV-105. For flights not involving an Active MPLM, the corresponding FDA limits for these parameters shall be set OSL/OSH.
- [2] For flights not involving an Active MPLM, the associated sensors will not be installed on the vehicle. Thus, the display values for these parameters will be essentially those associated with 0 PCM counts. For SPLY T and INTF T, the expected display value will be "-1L"; for FLOW RATE, the expected display value will be "160L." (Reference SASCB Action 10/09/03-01, 16-OCT-03.)

This Page Intentionally Blank

```

1 2 3 4 5
1 2 3 4 5 6 7 8 9 0 1 2 3 4 5 6 7 8 9 0 1 2 3 4 5 6 7 8 9 0 1 2 3 4 5 6 7 8 9 0 1
1 XXXX/XXX/169 PDRS STATUS XX X DDD/HH:MM:SS
2 DDD/HH:MM:SS
3 RMS SEL: XXXX
4 POR REF SEL: XXX LAST PT XXX
5 POHS ERR X.X ATT ERR X.XXX
6 X/P Y/Y Z/R
7 POHS POS REF ±XXXXXS ±XXXXXS ±XXXXXS
8 POHS ATT REF ±XXX.XS ±XXX.XS ±XXX.XS
9
10 POSITION ±XXXXXS ±XXXXXS ±XXXXXS
1 ATTITUDE ±XXX.XS ±XXX.XS ±XXX.XS
2
3 TRANS RATES ACT ±XX.XXS ±XX.XXS ±XX.XXS
4 CMD ±XX.XX ±XX.XX ±XX.XX
5
6 ROT RATES ACT ±XX.XXS ±XX.XXS ±XX.XXS
7 CMD ±XX.XX ±XX.XX ±XX.XX
8
9 JOINT ANGLES END EFFECTOR
10 SY SP EP RIGID CLOSE CAPTURE
1 ±XXX.XXS ±XXX.XXS ±XXX.XXS X X X
2 WP WY WR DERIG OPEN EXTEND
3 ±XXX.XXS ±XXX.XXS ±XXX.XXS X X X
4
5 (XX)
6

```

The PDRS STATUS display is an SM display (DISP 169) available in SM OPS 2 and 4 which provides data on point of resolution commanded and actual rates, position, and attitudes.

#### PARAMETER CHARACTERISTICS

CRT NAME	UNITS	DISPLAYED RANGE	STATUS INDICATORS					
			M	H	L	↑	↓	
RMS SEL	[1]	text	See Remarks					
LAST PT	[2]	text	See Remarks					
POR REF SEL	[3]	text	See Remarks					
POHS ERR	[4]	inches						
ATT ERR	[5]	radians						
POHS POS REF		inches		M				
POHS ATT REF		deg		M				
POSITIONS		inches		M				
ATTITUDES		deg		M				
TRANS RATES ACT		ft/sec		M				
CMD		ft/sec						
ROT RATES ACT		deg/sec		M				
CMD		deg/sec						
JOINT ANGLES	[6]	deg		M				
END EFFECTOR RIGID								
DERIG			'1' or '0'					
CLOSE			'1' or '0'					
OPEN			'1' or '0'					
CAPTURE			'1' or '0'					
EXTEND			'1' or '0'					

#### REMARKS

- [1] 'PORT', 'STBD', or 'OFF' to indicate the RMS selected for use. Field is blank when in suspend mode (i.e., I/O OFF).
- [2] LAST PT displays AUTO SEQUENCE LAST POINT, eliminating the need to toggle between SPEC 94 and SPEC 169 to monitor the last known point.

- [3]** 'ORB' if orbiter body axis system selected; 'REL' if a relative (crew-defined) axis system selected; see SPEC 94, item 30.
- [4]** POHS ERR displays the difference between (POHS) POS REF and POSITION of the algorithm in inches. This enables the crew to monitor error build up between the expected (commanded) and actual position of the POR.
- [5]** ATT ERR displays the difference between (POHS) ATT REF and ATTITUDE of the point of resolution of the algorithm in radians. This enables the crew to monitor error build up between the expected (commanded) and actual attitude of the POR.
- [6]** The angular configurations of the six RMS joints are defined as shoulder yaw (SY), shoulder pitch (SP), elbow pitch (EP), wrist pitch (WP), wrist yaw (WY), and wrist roll (WR).

	1	2	3	4	5
	1234567890	1234567890	1234567890	1234567890	1234567890
1	XXXX/XXX/177	EXTERNAL AIRLOCK	XX X	DDD/HH:MM:SS	
2				DDD/HH:MM:SS	
3	EXT A/L PRESS	XX.XXS	VESTIBULE		
4	A/L-VEST ΔP	XX.XXS	DEP VLV 1	XX/XX	
5			ISOL VLV 1	XX/XX	
6	INTERNAL TEMP		DEP VLV 2	XX/XX	
7	UPR BKHD T	XXXXS	ISOL VLV 2	XX/XX	
8	LWR BKHD T	XXXXS	TEMP 1/2	XXX/XXX	
9	EXTERNAL TEMP				
10	AFT STRUC T	XXXXS			
1					
2					
3	EXT A/L LINE TEMP				
4		ZN1	ZN2		
5	H2O SPLY T	XXXXS	XXXXS		
6	LCG2 SPLY T	XXXXS	XXXXS		
7	O2 SPLY LN T		XXXXS		
8					
9	H2O LINE PRESS				
20		1	2		
1	LCG SPLY P	XX.XXS	XX.XXS		
2	H2O XFER P	XX.XXS			
3					
4					
5					(XX)
6					

The EXTERNAL AIRLOCK display (DISP 177) is available in SM OPS 2 only. It provides information on external airlock atmosphere, vestibule depress valves, water lines, and structural heaters. The associated hardware is flown on all vehicles; this display is present on all flights to keep the software load generic.

### PARAMETER CHARACTERISTICS

CRT NAME	UNITS	DISPLAYED RANGE	STATUS INDICATORS				
			M	H	L	↑	↓
EXT A/L PRESS	psia	0 to 20	M	H	L	↑	↓
A/L-VEST ΔP [1]	psia	-20 to +20	M	H	L	↑	↓
INTERNAL TEMP							
UPR BKHD T	degF	0 to 160	M	H	L	↑	↓
LWR BKHD T	degF	0 to 160	M	H	L	↑	↓
EXTERNAL TEMP							
AFT STRUC T	degF	0 to 160	M	H	L	↑	↓
EXT A/L LINE TEMP							
H2O SPLY T ZN1 [2]	degF	0 to 160	M	H	L	↑	↓
ZN2 [2]	degF	0 to 160	M	H	L	↑	↓
LCG2 SPLY T ZN1 [2]	degF	0 to 160	M	H	L	↑	↓
ZN2 [2]	degF	0 to 160	M	H	L	↑	↓
O2 SPLY LN T [2,3]	degF	0 to 160	M	H	L	↑	↓
H2O LINE PRESS							
LCG SPLY P 1	psig	0 to 40	M	H	L		
2	psig	0 to 40	M	H	L		
H2O XFER P	psig	0 to 40	M	H	L		
VESTIBULE							
DEP VLV 1 [1]		OP/CL	M				
ISOL VLV 1 [1]		OP/CL	M				
DEP VLV 2 [1]		OP/CL	M				
ISOL VLV 2 [1]		OP/CL	M				
TEMP 1 [1]	degF	-74 to 174	M	H	L		
2 [1]	degF	-74 to 174	M	H	L		

### REMARKS

[1] These parameters are available only when the Orbiter Docking System (ODS) is flown.



- [2]** During EMU Checkout activities and orbiter-based EVAs, an alternate set of upper and lower FDA limits are applied to the EXT A/L LINE TEMP parameters by MCC via TMBU. This accounts for temperature changes due to flow in the corresponding fluid lines as well as to protect Flight Rule limit criteria for connection of the EMUs to the Service and Cooling Umbilicals.
  
- [3]** EXT A/L LINE TEMP O2 SPLY LN T has no default Level C reconfigurable upper or lower FDA limits.

	1										2										3										4										5									
	1	2	3	4	5	6	7	8	9	0	1	2	3	4	5	6	7	8	9	0	1	2	3	4	5	6	7	8	9	0	1	2	3	4	5	6	7	8	9	0	1	2	3	4	5	6	7	8	9	0
1	XXXX / XXX / 179										POWER TRANSFER										XX X										DDD / HH : MM : SS																			
2																															DDD / HH : MM : SS																			
3	1 / AXXXX										2 / BXXXX										3 / CXXXX																													
4	FC POWER (KW) XX.XS										XX.XS										XX.XS																													
5	MAIN VOLTS XX.XXS										XX.XXS										XX.XXS																													
6	PTU / MAIN BUS XXX										XXX																																							
7	PTU 1										PTU 2																																							
8	OPCU A B										A B																																							
9	OUT VOLTS XX.XXS XX.XXS										XX.XXS XX.XXS																																							
10	AMPS XX.XS XX.XS										XX.XS XX.XS																																							
1	TEMP XXXS XXXS										XXXS XXXS																																							
2	TRIP XX XX XX XX										XX XX XX XX																																							
3	XX XX XX XX										XX XX XX XX																																							
4	XXX XX XXX XX										XXX XX XXX XX																																							
5	XXX XX XXX XX										XXX XX XXX XX																																							
6	APCU																																																	
7	OUT VOLTS XXX.XS										XXX.XS																																							
8	AMPS XX.XS										XX.XS																																							
9	IN AMPS XX.XS										XX.XS																																							
20	TEMP XXXS										XXXS																																							
1	OUTPUT XXX										XXX																																							
2	TRIP XX XX XXX XX										XX XX XXX XX																																							
3	XXX XX XXX XX										XXX XX XXX XX																																							
4																																																		
5																																																		
6																															(XX)																			

The POWER TRANSFER display is an SM display (DISP 179) available in SM OPS 2 which provides detailed status information on the Station to Shuttle Power Transfer System.

### PARAMETER CHARACTERISTICS

CRT NAME	UNITS	DISPLAYED RANGE	STATUS INDICATORS					
			M	H	L	↑	↓	
1/A, 2/B, 3/C	[1] text	'-TIE' or blank	M					
FC POWER	kW	0 to 20	M	H	L			
MAIN VOLTS	volts	0 to 40	M	H	L	↑	↓	
PTU / MAIN BUS	text	'ON' or 'OFF'	M					
PTU: OPCU: OUT VOLTS	volts	25 to 35	M	H	L		↓	
AMPS	amps	0 to 90	M	H	L	↑		
TEMP	degF	0 to 225	M	H	L	↑		
TRIP	[2] text	'IN OC' or blank	M			↑		
	[3] text	'IN UV' or blank	M			↑		
	[4] text	'OUT UV' or blank	M			↑		
	[5] text	'OUT OV' or blank	M			↑		
APCU: OUT VOLTS	volts	0 to 150	M	H	L	↑	↓	
AMPS	amps	0 to 20	M	H	L	↑		
IN AMPS	amps	0 to 90	M	H	L	↑		
TEMP	degF	0 to 225	M	H	L	↑		
OUTPUT	text	'ON' or 'OFF'	M			↑		
TRIP	[3] text	'IN UV' or blank	M			↑		
	[6] text	'OUT OC' or blank	M			↑		
	[4] text	'OUT UV' or blank	M			↑		
	[5] text	'OUT OV' or blank	M			↑		

### REMARKS

- [1] 1/A (or 2/B or 3/C) specifies which FC/MN Bus is connected to the TIE Bus.
- [2] IN OC = Input Over Current
- [3] IN UV = Input Under Voltage
- [4] OUT UV = Output Under Voltage
- [5] OUT OV = Output Over Voltage
- [6] OUT OC = Output Over Current

PL CRT DISPLAYS

PAGE

SPEC 111 SL MEMORY DUMP..... 4-56  
OPS 9011 MASS MEMORY R/W ..... (SEE SM, PAGE 4-26)  
SPEC 100 GTS DISPLAY ..... (SEE GNC, OPS G9, PAGE 3-92)

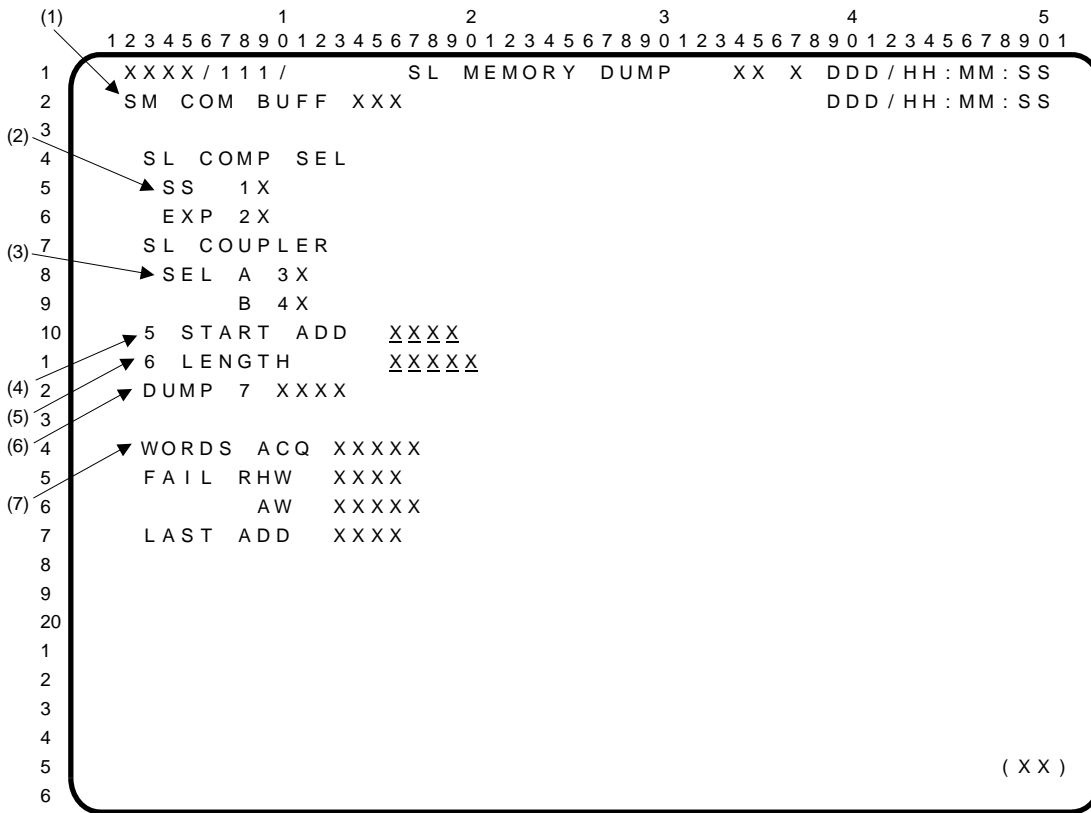

SL MEMORY DUMP is a specialist function (SPEC 111) available in PL OPS 9. This display provides control and monitoring for Spacelab Subsystem (SS) or Experiment (EXP) Computer memory dump during prelaunch checkout.

- (1) SM COM BUFF. 'BSY' is displayed next to SM COM BUFF to indicate that the SM COMMON BUFFER is in use; 'RDY' is displayed when it is ready/available.
- (2) SL COMP SEL. Items 1 and 2 select which computer is to be dumped, SS or EXP, respectively. These items are mutually exclusive; an '\*' indicates the selected item. The display is initialized with SS selected. Execution of these items is legal only when Spacelab Memory is not being loaded into GPC or being dumped from GPC.
- (3) SL COUPLER. Items 3 and 4 select the MDM Coupler (A and B, respectively) to be used to communicate with the selected Spacelab computer. These items are mutually exclusive; an '\*' indicates the selected item. The display is initialized with Coupler A selected. Execution of these items is legal only when Spacelab Memory is not being loaded into GPC or being dumped from GPC.
- (4) START ADD. Item 5 provides the capability to specify the starting address (0000 to FFFF in HEX) of the Spacelab computer selected for dump. Entry of values outside the 0000-FFFF range will be rejected and a class 5 error message generated. The display is initialized with START ADD equal to 0.
- (5) LENGTH. Item 6 provides the capability to specify the number of words to be dumped beginning at the START ADD. The value entered is restricted to the range 1 to 16384. Entry of values outside this range or while Spacelab Memory is being loaded or dumped will be rejected and a class 5 error message generated. The display is initialized with LENGTH equal to 1.

SL MEMORY DUMP (Cont):

- (6) DUMP. Item 7 is used to initiate a dump from the selected Spacelab computer through the selected MDM coupler. A successful dump request will set the SM COMMON BUFFER IN USE flag 'ON', set to all zeroes the Spacelab computer memory data words acquired (WORDS ACQ), FAIL RHW, AW, and last address (LAST ADD), and will start loading Spacelab Memory into the GPC for dump. Dump status is displayed after item 7 – blank when the display is first called (indicating that no dump has yet been requested), 'LOAD' when Spacelab Memory is being loaded into GPC, 'DUMP' when Spacelab Memory is being dumped from the GPC, 'CPLT' when the dump is complete, or 'FAIL' if the Spacelab computer to GPC transfer for the dump was terminated due to an error. An item 7 dump request will be rejected and a class 5 error message generated if the SM COMMON BUFFER is busy or if the sum of START ADD plus LENGTH exceeds 65536.
- (7) When an error causes termination of data transfer from the Spacelab computer to GPC, the data fields below DUMP 7 'FAIL' provide the following information related to that termination: the total number of words acquired (WORDS ACQ) through the last successful read, the contents of the Response Header Word (RHW) and Address Word (AW) for the failed response, and the last valid data word address (LAST ADD).

This Page Intentionally Blank

## BACKUP FLIGHT SYSTEM (BFS) DISPLAYS

	<u>PAGE</u>
<u>BFS SYSTEM SOFTWARE</u> .....	5-3
OPS 0001 BFS MEMORY .....	5-4
DISP 99 FAULT .....	(SEE SYS S/W, PAGE 2-13)
<u>BFS OPS G1 (ASCENT)</u> .....	5-7
OPS 10X1 XXXXXX TRAJ 1 .....	5-8
OPS 1031 XXXXXX TRAJ 2 .....	5-9
OPS 1041 XXXXX MNVR YYYYY .....	(SEE GNC, OPS G1, PAGE 3-7)
DISP 18 GNC SYS SUMM 1 .....	5-10
DISP 19 GNC SYS SUMM 2 .....	(SEE GNC, OPS G2, PAGE 3-24)
SPEC 50 HORIZ SIT .....	5-12
SPEC 51 OVERRIDE .....	5-15
SPEC 55 GPS STATUS .....	5-19
<u>BFS OPS G3 (ENTRY)</u> .....	5-23
OPS 3011 XXXXX MNVR YYYYY .....	(SEE GNC, OPS G1, PAGE 3-7)
OPS 3041 ENTRY TRAJ 1 .....	5-24
OPS 3041           2 .....	5-26
OPS 3041           3 .....	5-26
OPS 3041           4 .....	5-27
OPS 3041           5 .....	5-27
OPS 3051 VERT SIT 1 .....	(SEE GNC, OPS G3, PAGE 3-64)
OPS 3051           2 .....	(SEE GNC, OPS G3, PAGE 3-67)
DISP 18 GNC SYS SUMM 1 .....	(SEE BFS, OPS G1, PAGE 5-10)
DISP 19 GNC SYS SUMM 2 .....	(SEE GNC, OPS G2, PAGE 3-24)
SPEC 50 HORIZ SIT .....	(SEE BFS, OPS G1, PAGE 5-12)
SPEC 51 OVERRIDE .....	(SEE BFS, OPS G1, PAGE 5-15)
SPEC 55 GPS STATUS .....	(SEE BFS, OPS G1, PAGE 5-19)
<u>BFS OPS G6 (ABORTS)</u> .....	5-29
OPS 6011 RTLS TRAJ 2 .....	5-30
OPS 6021 VERT SIT 1 .....	(SEE GNC, OPS G3, PAGE 3-64)
OPS 6031 VERT SIT 2 .....	(SEE GNC, OPS G3, PAGE 3-67)
DISP 18 GNC SYS SUMM 1 .....	(SEE BFS, OPS G1, PAGE 5-10)
DISP 19 GNC SYS SUMM 2 .....	(SEE GNC, OPS G2, PAGE 3-24)
SPEC 50 HORIZ SIT .....	(SEE BFS, OPS G1, PAGE 5-12)
SPEC 51 OVERRIDE .....	(SEE BFS, OPS G1, PAGE 5-15)
SPEC 55 GPS STATUS .....	(SEE BFS, OPS G1, PAGE 5-19)
<u>BFS SM OPS 0</u> .....	5-31
OPS 0001 THERMAL .....	5-32
SPEC 63 PL BAY DOORS .....	(SEE SM, PAGE 4-5)
DISP 78 SM SYS SUMM 1 .....	5-34
DISP 79 SM SYS SUMM 2 .....	5-36
DISP 168 CARGO LOOP .....	5-38

This Page Intentionally Blank



BFS SYSTEM SOFTWARE

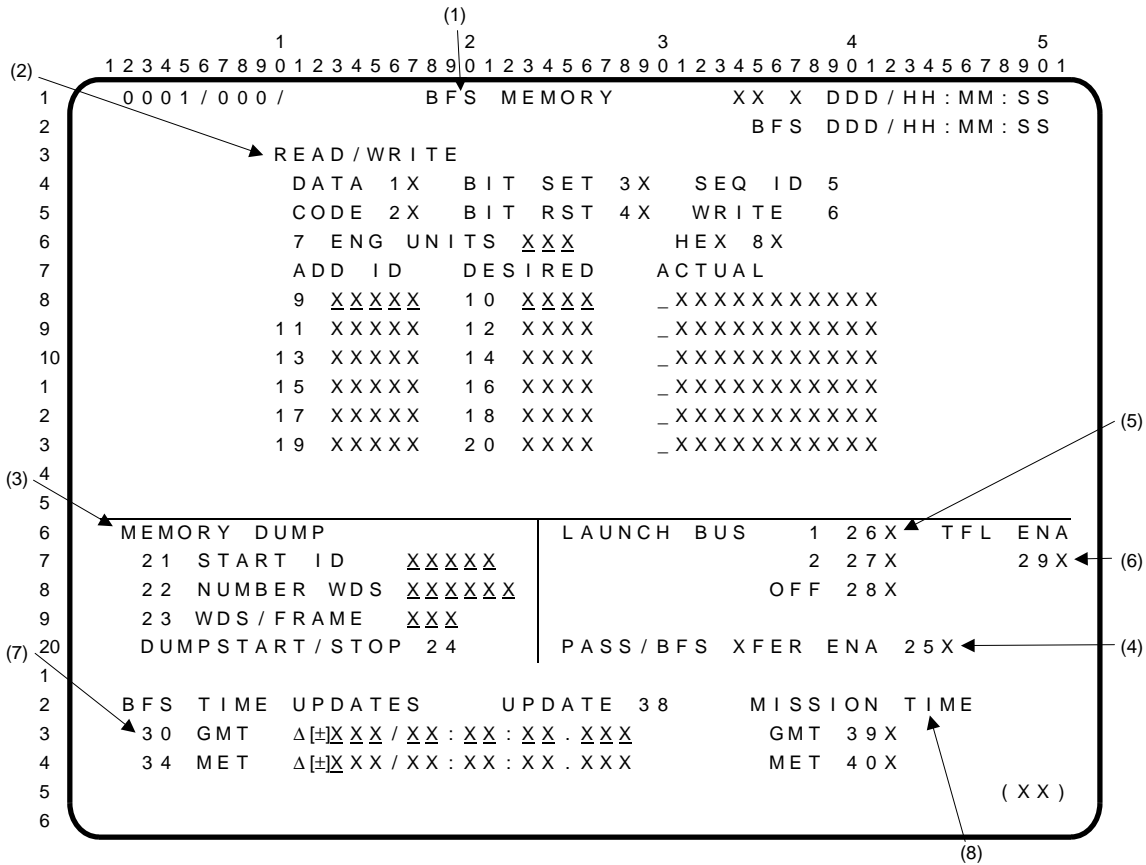

(1) BFS MEMORY display. This display is the format always associated with OPS 000 and SPEC 000. The BFS Memory provides crew controls to: (2) review and change the value contained in any specified GPC memory location; (3) perform a main memory dump; (4) transfer initialization data from PASS to BFS; (5) assign the launch data buses; (6) enable the auto TFL function; (7) update BFS GMT and MET, and; (8) toggle BFS Mission Time display field between MET and GMT.

(2)\* READ/WRITE. Quantities stored in memory are displayed as follows: The memory addresses of the parameters are input in the ADD ID column using items 9, 11, 13,... 19. When this entry is made, the specified parameter is displayed in the ACTUAL column in the units specified by item 8 (HEX) or item 7 (ENG UNITS). Execution of item 5 (SEQ ID) displays sequential memory locations starting with the most recently entered ADD ID until the display is filled. Execution of item 5 or entering individual ADD IDs causes the corresponding DESIRED field(s) to blank. The parameters are scaled according to item 7 or 8.

For item 7 entries of 200 thru 210, the ACTUAL column displays a fixed EU format of XXXXX.XXXXX. If the converted value is 100,000 or greater, the high-order digits are not displayed. In such a case, use of the HEX feature (item 8) is recommended to prevent confusion.

All changes to memory are done in an arm/fire manner. The parameters to be changed are specified by displaying the required memory locations in the 'ADD ID' column, entering the new value in the DESIRED column using items 10, 12, 14,... 20, and executing item 6 (WRITE). DESIRED entries are in HEX only. The display is initialized with item 1 (DATA) selected so that WRITE operations apply to unprotected areas of memory. If item 2 (CODE) is executed, the word 'CODE' flashes and the next WRITE operation can alter protected areas of memory. After that WRITE is completed, the mode switches back to DATA.

Individual bits in the unprotected memory area can be set or reset by using items 3 (BIT SET) and 4 (BIT RST) to establish the required mode, displaying the parameter to be changed, entering a 4-character hexadecimal word (Mask) in the DESIRED column identifying the bits to be set or reset, and executing item 6 (WRITE). Up to six parameters may be changed with one WRITE. Parameters to be changed must be displayed in HEX.

## BFS MEMORY (Cont):

Items 1 and 2, 3 and 4, and 7 and 8 are mutually exclusive, and the active item is designated by an '\*' displayed next to the item number.

NOTE: When the BFS MEMORY SPEC is called, the READ/WRITE and MEMORY DUMP sections are initialized to DATA, HEX, and all other fields are blank. If the BFS MEMORY is being viewed on an OPS display and on another DEU driven by the same GPC or RS the BFS MEMORY SPEC is requested, both displays will be initialized to the default item selections (DATA and HEX).

- (3) **MEMORY DUMP.** Items 21 (START ID) and 22 (NUMBER WDS) define the main memory data to be dumped via the downlist. The absolute main memory address in hexadecimal of the dump is entered in item 21 and the number of sequential 16-bit words of main memory to be dumped is entered via item 22. The entire main memory may be dumped by execution of these two item numbers along with the WDS/FRAME (item 23). If the addition of the starting address and the number of words total beyond the GPC address limit, an error message is generated.

Item 23 (WDS/FRAME) is provided to define the number of 16-bit words in the downlist frame to be used for header and main memory data. Entry of this item controls the length of the data content of the downlist frame so that a subset of the total downlist frame can be used for the 64 kbps downlink frame. The number of words per frame data entry is limited to two values, 16 or 32; an entry of any other value will be rejected and result in an operator error message.

Item 24 (DUMP START/STOP) serves a dual purpose. For a dump initialized using values in items 21 (22, 23), item 24 selects the dump. Upon entry of this item, items 21 and 22 show the current values as the dump proceeds to completion, and then are blanked.

For a single item entry dump (standard table I-loaded values for items 21, 22, and 23), item 24 starts the dump. It also serves as a toggle switch to stop a dump that is already in progress.

- (4) **PASS/BFS XFER ENA.** Execution of item 25 enables reception of initialization data from PASS by BFS and causes an '\*' to be displayed. The '\*' is cleared when the transfer is complete. This transfer is valid only in OPS 0. Must be used with the GTS DISPLAY (PFS, OPS G9, SPEC 100).
- (5) **BUS CONFIG.** Execution of item 26 or 27 assigns the BFS GPC to LDB 1 or 2, respectively, and initiates polling. Item 28 terminates polling.
- (6) Item 29 is a toggle control which enables/disables the auto TFL function. If enabled, it will load and verify the PCMMU whenever a PCMMU switchover occurs. The display is initialized with this item enabled.
- (7) **BFS TIME UPDATES.** Items 30 through 38 provide the capability to update the BFS GPC GMT and MET.

Items 30 thru 33 allow the input of a delta time in days, hours, minutes, seconds, and milliseconds to the GMT of the BFS GPC. Upon execution of item 38 (time UPDATE), the values loaded in items 30 thru 33 are used to update the BFS GPC GMT. The resulting GMT must be greater than or equal to day 1 and less than day 400. If item 38 is executed, and the resulting GMT is not within these limits, an 'ILLEGAL ENTRY' message shall be displayed, the GMT shall not be updated, all delta time entries shall be reset to zero and blanked on the display, and the GMT sign shall be blanked on the display. An update of the BFS GMT shall be legal in OPS 0 only. Therefore, if the BFS is not in OPS 0, an entry of items 30 thru 33 shall result in an 'ILLEGAL ENTRY' message being displayed and the input rejected.

Items 34 thru 37 allow the input of a delta time in days, hours, minutes, seconds, and milliseconds to the MET of the BFS GPC. Upon execution of item 38 (time UPDATE), the values loaded in items 34 thru 37 are used to update the BFS GPC MET. The resulting MET must be greater than or equal to day 0 and less than day 400. If item 38 is executed, and the resulting MET is not within these limits, an 'ILLEGAL ENTRY' message shall be displayed, the MET shall not be updated, all delta time entries shall be reset to zero and blanked on the display, and the MET sign shall be blanked on the display. An update of the BFS MET shall be legal in MM301 only. Therefore, if the BFS is not in MM301, an entry of items 34 thru 37 shall result in an 'ILLEGAL ENTRY' message being displayed and the input rejected.

## BFS MEMORY (Cont):

The sign of the lowest item number entered in a set (with a non-zero value) shall determine the sign of the entire set (i.e., items 30 thru 33 or 34 thru 37). If a value of zero is entered for any of the items 30 thru 37, that item shall be blanked on the display and its sign shall not contribute to the determination of the sign of the entire set.

Items 30 thru 37 shall be initialized to zero and shall be initially blank on the display. The GMT/MET delta sign fields shall also be initially blank. These items shall be re-initialized and blanked upon any major Mode transition, including the GMT/MET sign fields.

Item 38 shall be legal in OPS 0 or MM301 only, and is legal only when at least one of items 30 thru 37 has a non-zero value. Therefore, if the BFS is not in OPS 0 or MM301, or if all of items 30 thru 37 have zero values, an entry of item 38 shall result in an 'ILLEGAL ENTRY' message being displayed and the input rejected.

Upon a valid entry of item 38, the GMT/MET delta time entries shall be converted to seconds prior to being sent to MTU Redundancy Management (MTURM), where the actual update will occur.

- (8) MISSION TIME. Items 39 and 40 are used to select either GMT (item 39) or MET (item 40) as the source for mission time for all BFS driven displays. An "\*" shall be displayed next to the selected source, and a blank shall indicate that a source, GMT or MET, is not selected for driving mission time. Source selection carries forward across OPS transitions until manually changed. Items 39 and 40 shall be legal in OPS 0, 1, 3, and 6. The source selection shall be initialized to MET and an "\*" shall be initially displayed next to item 40.

## \*PROGRAM NOTES

- (2) DESIRED Field Not Blanking. Old data in the DESIRED column of the READ/WRITE section will not blank when new addresses are entered into the ADD ID columns. Always reselect a mode (item 1 thru 4, or 7, or 8) to clear the DESIRED column prior to entering new addresses.

BFS OPS G1 (ASCENT)

PAGE

OPS 10X1 XXXXXX TRAJ 1.....	5-8
OPS 1031 XXXXXX TRAJ 2.....	5-9
OPS 1041 XXXXXX MNVR YYYYY.....	(SEE GNC, OPS G2 PAGE 3-24)
DISP 18 GNC SYS SUMM 1.....	5-10
DISP 19                   2.....	(SEE GNC, OPS G2 PAGE 3-24)
SPEC 50 HORIZ SIT.....	5-12
SPEC 51 OVERRIDE.....	5-15
SPEC 55 GPS STATUS.....	5-19

OPS G1  
(ASCENT)

**OPS G1  
(ASCENT)**

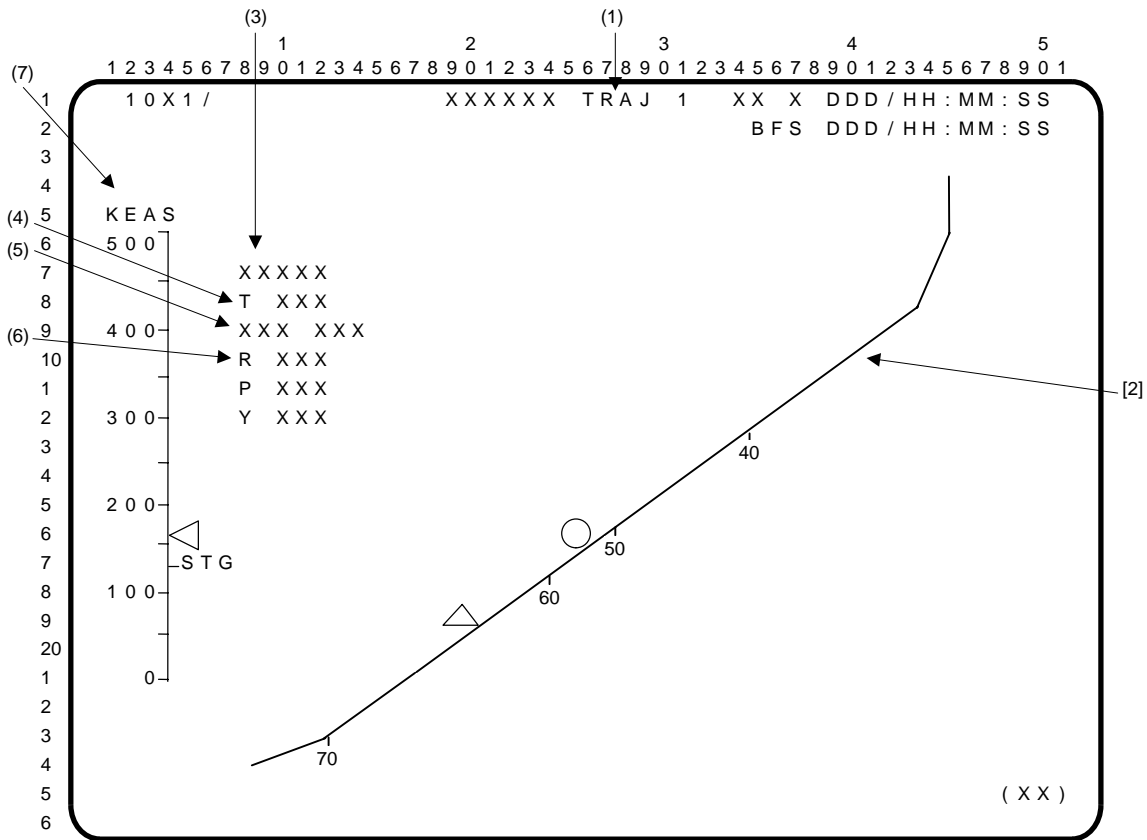

NOTE: [ ] denotes trajectory-dependent data.

- (1) XXXXXX TRAJ 1. A GNC operational sequence (OPS) display available in OPS 1 (BFS only). The title of this display is dynamic. It is LAUNCH TRAJ 1 for MM101. In MM102 it is ASCENT TRAJ 1, except in an abort mode where it reflects the abort mode (RTLS TRAJ 1 or ATO TRAJ 1). It is used to monitor guidance performance until SRB staging.
- [2] The central plot is an altitude vs. velocity relative to launch site profile from the mission trajectory. Tick marks on the curved line correspond to inertial ADI angles of 70, 60, 50, and 40 degrees. The current vehicle state from navigation is shown by a moving triangle. The predicted state for 20 seconds in the future is indicated by a circle.
- (3) PC < 50 (SRB chamber pressure less than 50 psi) appears on the display whenever that discrete is sent to the staging sequence.
- (4) T is a digital readout of throttle command to the engines in percent. Range is 65 to 109 percent.
- (5) 'SEP INH' is displayed flashing if the SRB SEP inhibit discrete is set by the SRB SEP sequencer.
- (6) BFS-computed roll, pitch, and yaw errors are displayed prior to BFS engage for comparison with PASS-driven ADI error needles. Each error value is preceded by one of the following characters: 'U', 'D', 'L', or 'R'. These indicate the fly-to direction of that error. If the roll error is 100 degrees or greater, an overflow indicator of 'R >>' or 'L >>' is displayed for a right or left fly-to error, respectively. These errors and signs are not displayed after BFS engage.
- (7) The scale on the left is Equivalent Airspeed in knots (KEAS), with a moving overbright, oversize triangle indicating the current KEAS. A tick mark at a mission-dependent value indicates safe staging KEAS. The moving indicator will flash if KEAS exceeds a mission-dependent value.

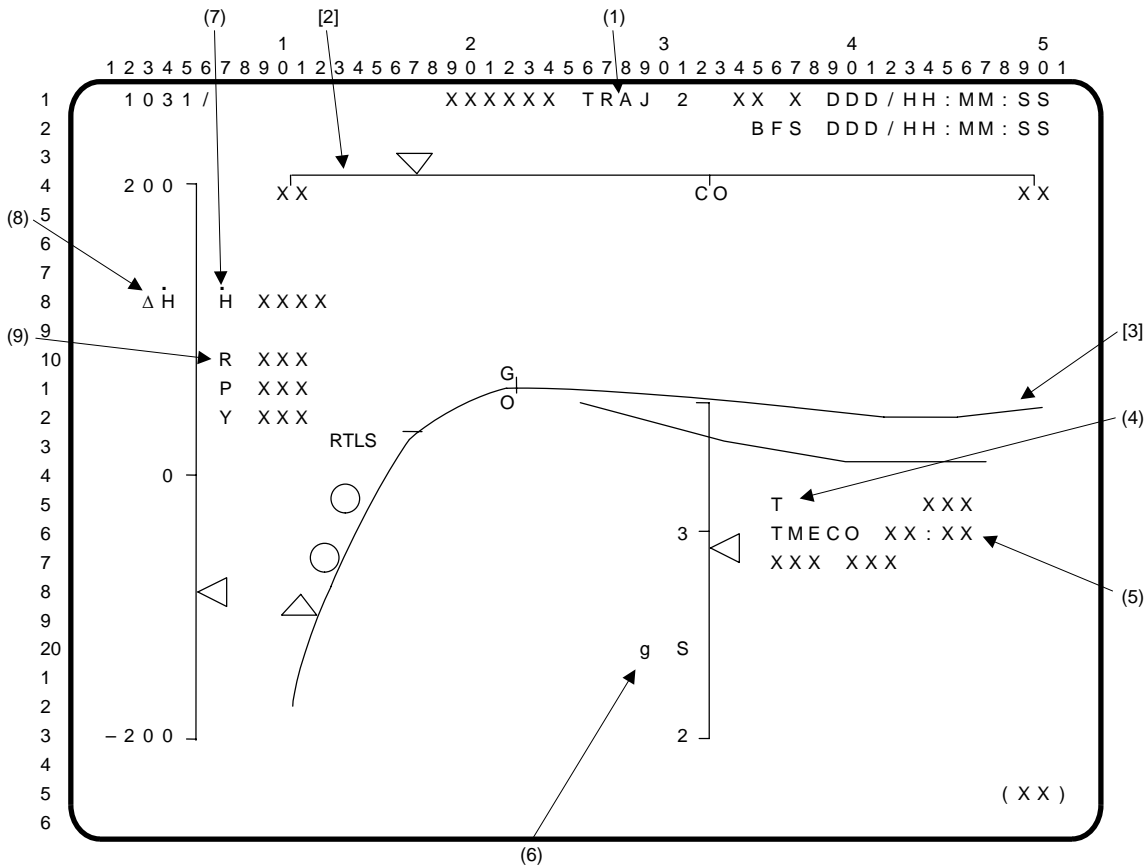

NOTE: [ ] denotes trajectory-dependent data.

- (1) XXXXXX TRAJ 2 is a GNC operational sequence (OPS) display available in OPS 1 MM103 (BFS only). The title of this display is dynamic and will be ASCENT TRAJ 2 unless an abort is initiated. At TAL or ATO initiation, it will indicate the abort mode (TAL TRAJ 2 or ATO TRAJ 2). This display is used to monitor the guidance performance during the second-stage boost.
- [2] The scale across the top is an inertial velocity (VI) scale within mission dependent, I-Loaded limits (1,000 fps apart) with a nominal cutoff (CO) tick mark. CO also represents zero  $\Delta V$  to go for a TAL ABORT and will be the TAL MECO indicator. Present VI is from navigation and TAL  $\Delta V$  to go are indicated by a moving triangle.
- [3] The central plot is inertial velocity vs. altitude. Abort regions are indicated along the plot as shown (e.g., RTLS, GO, etc.). The current vehicle state from navigation is shown by a moving triangle. Predicted states for 30 and 60 seconds in the future are shown by circles.
- (4) T is the throttle command in percent.
- (5) TMECO is predicted time of MECO (from lift-off) from guidance. 'SEP INH' is displayed flashing if the ET SEP inhibit discrete is set by the ET SEP sequencer.
- (6) g's is total load factor in g's. The indicator will flash if 3 g's are exceeded.
- (7)  $\dot{H}$  is a digital readout of the present radius rate from navigation in fps.
- (8)  $\Delta \dot{H}$  is the radius rate from navigation minus the nominal radius rate for the present velocity. Present  $\Delta \dot{H}$  is indicated by a moving, left-pointing triangle which flashes if off-scale.
- (9) BFS-computed roll, pitch, and yaw errors are displayed prior to BFS engage for comparison with PASS-driven ADI error needles. Each error value is preceded by one of the following characters: 'U', 'D', 'L', or 'R'. These indicate the fly-to direction of that error. If the roll error is 100 degrees or greater, an overflow indicator of 'R >>' or 'L >>' is displayed for a right or left fly-to error, respectively. These errors and signs are not displayed after BFS engage.

```

1 2 3 4 5
1 2 3 4 5 6 7 8 9 0 1 2 3 4 5 6 7 8 9 0 1 2 3 4 5 6 7 8 9 0 1
1 XXXX/XXX/018 GNC SYS SUMM 1 XX X DDD/HH:MM:SS
2 BFS DDD/HH:MM:SS
3
4 SURF POS MOM DPS 1 2 3 4
5 L OB XXX.XS XXS MDM FF S S S S
6 IB XXX.XS XXS FA S S S S
7 R IB XXX.XS XXS PL S S
8 OB XXX.XS XXS
9 AIL XXX.X
10 RUD XXX.X FCS CH 1 2 3 4
1 SPD BRK XXX.X S S S S
2 BDY FLP XXX.X
3
4 MPS L C R NAV 1 2 3 4
5 HE TK P XXXXS XXXXS XXXXS IMU S S S
6 REG P A XXXXS XXXXS XXXXS TAC S S S
7 B XXXXS XXXXS XXXXS ADTA S S S S
8 dP/dT XXXS XXXS XXXS
9 MPS PNEU HE P
20 ULL P LH2 XX.XS XX.XS XX.XS TK XXXXS
1 LO2 XX.XS XX.XS XX.XS REG XXXXS
2 ACUM XXXXS
3 GH2 OUT P XXXXS XXXXS XXXXS MANF P LH2 XXXS
4 GO2 OUT T XXXXS XXXXS XXXXS LO2 XXXS
5 (XX)
6

```

GNC SYS SUMM 1 is a BFS GNC display (DISP 18) available in OPS 1, 3, and 6 via the SYS SUMM key. Digital data and/or status information which support aerosurfaces, Main Propulsion System (MPS), Data Processing System (DPS), flight control subsystem channels (FCS CH), and navigation sensor subsystems are displayed.

PARAMETER CHARACTERISTICS

CRT NAME	UNITS	DISPLAYED RANGE	STATUS INDICATORS				
			M	H	L	↑	↓
[1] SURF: L(R) OB(IB) POS MOM AIL RUD SPD BRK BDY FLP	deg percent deg deg percent percent	U36.5 to D21.5 -99 to +99 L5.0 to R5.0 L27.1 to R27.1 0 to 100 0 to 100				↑	↓
[2] MPS: HE TK P REG P (A,B) [8] dP/dT ULL P LH2 [10] LO2 [10] GH2 OUT P L, C, R [9] GO2 OUT T L, C, R [9] MPS PNEU HE P TK [3] REG [8] ACUM MANF P LH2 LO2	psia psia psi/3 sec psia psig psia deg psia psia psia psia psia	0 to 5000 0 to 1000 0 to 50 12 to 52 0 to 30 0 to 5000 -250 to +1000 0 to 5000 0 to 1000 0 to 1000 0 to 100 0 to 300	M M  M M M M M M M M M			↑ ↑ ↑ ↑  ↑ ↑ ↑ ↑ ↑ ↑	↓ ↓ ↓ ↓ ↓ ↓ ↓ ↓ ↓ ↓ ↓ ↓
DPS MDM FF 1-4 [4] FA 1-4 [4] PL 1-2			M M				↓ ↓ ↓
FCS CH 1-4 [5]			M				↓
[6] NAV: IMU 1-3 [7] TAC 1-3 [1] ADTA 1-4 [1]							↓ ↓ ↓



GNC SYS SUMM 1 (Cont):

REMARKS

- [1]** OPS 3, MM602, and MM603 only.
- [2]** OPS 1 and 6.
- [3]** Limit sensing and fault annunciation are terminated at MECO command.
- [4]** 'M' status indicates preengage failure of BFS to track PFS.
- [5]** Only the first actuator failure on a given channel will be annunciated. Subsequent failures of different actuators on the same channel will not be annunciated unless the first failure has been reset. (UB08324)
- [6]** '↓' represents failure, missing data, or IMU deselection by item entry on BFS OVERRIDE display.
- [7]** OPS 1 and MM601.
- [8]** OPS 1, 3, and 6.
- [9]** Limit sensing and fault annunciation begin at MM102 and end at MECO.
- [10]** Low limit sensing and fault annunciation begin at MM102 and end at MECO.

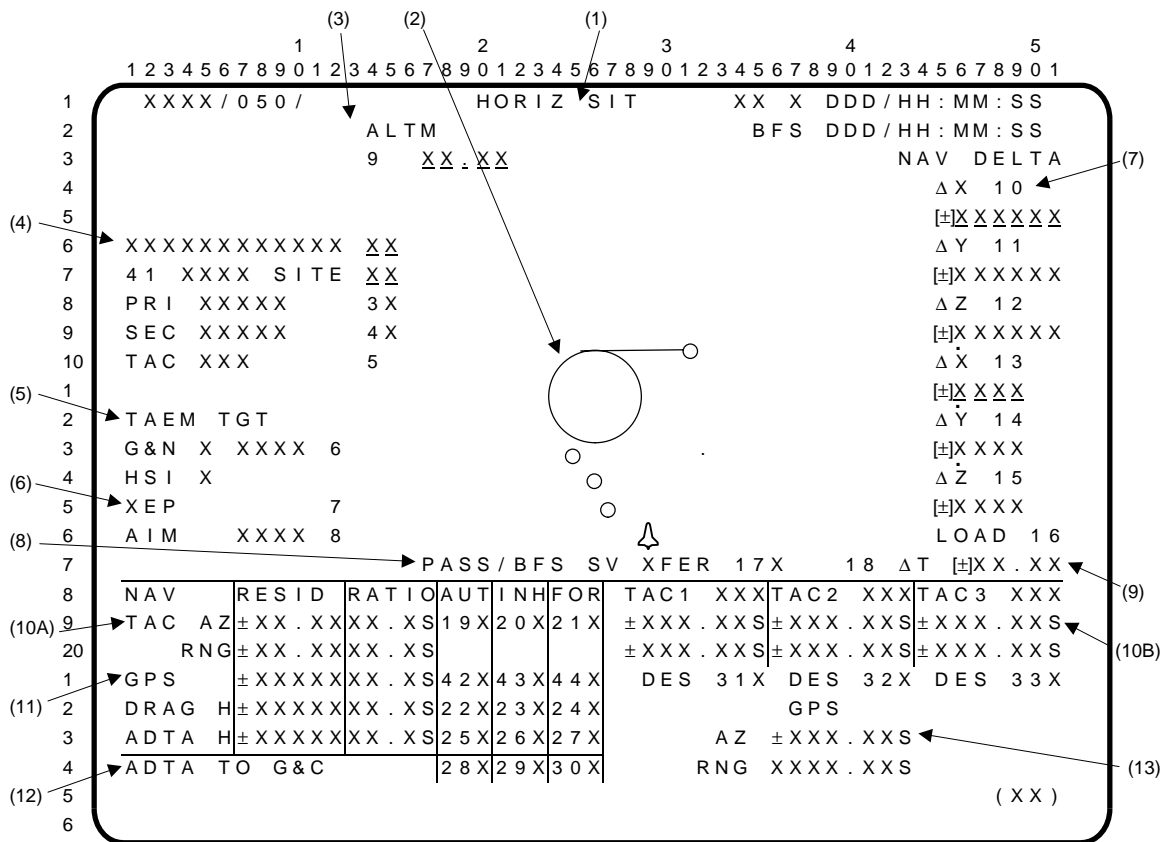

- (1) **HORIZ SIT display.** A GNC SPEC available in BFS OPS sequence 1, 3, and 6. Includes (2) display of orbiter position and heading relative to heading alignment circle; (3) altimeter setting control; (4) TAL site, landing site, runway, and TACAN designation controls; (5) approach indicators and control; (6) entry point indicator and control; (7) NAV update controls; (8) PFS to BFS state vector transfer controls; (9) delta time state vector update controls; (10) navigation filter displays and controls; and (11) GPS performance data; (12) air data to GNC control, and (13) GPS position data.
- (2)\* The graphic portion of the display contains a fixed orbiter symbol, three dynamic position predictors, heading alignment circle (HAC), runway touchdown point (circle), and a linear extension from the touchdown point to the circle intersection point. The predictor symbols represent the orbiter position predicted 20, 40, and 60 seconds in the future. The heading alignment circle and runway symbol move relative to the orbiter symbol while the orbiter symbol is fixed on the display. Landing site variable data are blanked at beginning of approach and landing (A/L).
- (3) Item 9 is used to input the barometric altimeter (ALTM) setting corrected to mean sea level (MSL).
- (4) Item 40 (text is 40 TAL SITE X X; appears above item 41) allows selection of the TAL landing site in OPS 1. The display is initialized with the primary (I-loaded) TAL site selected and thereafter reflects crew inputs (possible index of 1 to 25). If a TAL abort is declared, item 40 will blank; the TAL site index will appear next to item 41; and the associated runway and TACAN data will appear next to items 3, 4, and 5. Item 40 is available in OPS 1 only. Execution in any other OPS or following an RTLS or TAL abort selection will result in an 'ILLEGAL ENTRY' message. Entry of any RTLS site or an erroneous TAL site will result in the message 'TARGET ERR TAL' being generated.

## HORIZ SIT (Cont):

Item 41 allows the selection of the landing site in OPS 1, 3, or 6 from a possible index of 1 to 25 landing areas. Each site consists of one primary (PRI) and one secondary (SEC) runway, two TACANs, and an MSBLS (where available). 'RTL5' is displayed throughout OPS 1 and 6 unless a TAL abort has been declared, in which case 'TAL' is displayed. In OPS 3, 'LAND' is displayed. The display is initialized in MM101 with the primary (I-loaded) RTL5 site selected. An alternate site can be chosen (which also specifies the MECO targets) up until fine countdown (MECO minus 10 sec) in OPS 1 and until powered pitchdown in OPS 6. After powered pitchdown, the RTL5 landing site can be changed but the MECO targets will not update. Prior to RTL5 or TAL abort selection, entry of any TAL site or an erroneous RTL5 site will result in the message 'TARGET ERR RTL5' being generated. If a TAL abort has been declared, entry of an RTL5 site will result in the message 'TARGET ERR TAL' being generated.

Items 3 and 4 allow selection of either the primary or secondary runway of a selected landing site. The IDs of the primary and secondary runways are displayed next to items 3 and 4, respectively. Primary is automatically selected (indicated by an **\***) once a landing site is specified. Items 3 and 4 are mutually exclusive.

Item 5 provides the capability to select either of two TACANs associated with a selected landing site. When a landing site is selected, the primary TACAN is automatically selected, and subsequent executions of item 5 alternately select the secondary and primary TACANs. The channel ID of the selected TACAN is displayed next to item 5.

- (5)** Item 6 designates the HAC to be used for targeting during entry or RTL5. 'OVHD' or 'STRT' is displayed next to item 6 to indicate an overhead or straight-in approach. The display is initialized in MM101 with OVHD selected and it remains selected unless downmoded by crew selection of the alternate HAC in MM304, MM305, MM602, or MM603. If a new landing site (item 41) is selected, the approach will be reinitialized to OVHD. If the energy level is too low, but the range to the runway and the required turn angle are within I-loaded limits, OVHD will flash and a Class 3 message will be generated. The flashing terminates once a straight-in approach is selected. Indicators 'L' and 'R' are also displayed at G&N and HSI to identify whether the left or right HAC is the target point. These indicators are initialized upon transitioning into MM304, MM601 after MECO (G&N), or MM602 (HSI) and will be blank prior to that time. Item 6 is legal only in MM101, MM304, MM305, MM602, and MM603 and can be used only once in MM101.
- (6)** Item 7 (XEP) allows the crew to alternately select the nominal entry point or the minimum entry point for guidance targeting. Selection is indicated by 'NEP' or 'MEP', respectively. The indicator is initially driven to NEP. Item 8 (AIM) allows the crew to alternately redesignate the glide slope ground intercept point between nominal and closest to the runway (for high head winds) until TAEM/Autoland interface. Selection is indicated next to item 8 by 'NOM' and 'CLSE'. The display is initialized with 'NOM' selected.
- (7)** NAV UPDATE. Items 10 thru 15 are used to enter desired deltas to each of six NAV STATE components,  $\Delta X$ ,  $\Delta Y$ ,  $\Delta Z$ ,  $\Delta XDOT$ ,  $\Delta YDOT$ , and  $\Delta ZDOT$  (in runway coordinates). Item 16 is used to update the NAV STATE with the deltas entered by items 10 thru 15. It also provides the capability to perform a PFS to BFS state vector update using item 17. Upon NAV UPDATE completion, these items are zeroed.
- (8)** Item 17 (PASS/BFS SV XFER) allows the crew to command the BFS to read the PFS state information and display deltas between the PFS and BFS state vectors in items 10 thru 15. These deltas are in U, V, W coordinates; i.e., an attitude error ( $\Delta Z$  in runway coordinates) will show up in  $\Delta X$  slot. Execution of item 16 updates the BFS state vector with the PFS-BFS deltas.
- (9)** Item 18 ( $\Delta T$ ) provides the capability to update state vector downtrack errors by means of adding or subtracting a delta time in seconds. The update is performed after a time is entered via item 18 and is followed by the execution of item 16 (LOAD). The delta time display field is zeroed when the display is first called and will be rezeroed upon completion of a delta time update by Entry Navigation. Item 18 is legal in OPS 3 only; executing this item in any other OPS will cause an 'ILLEGAL ENTRY' message to be generated.

## HORIZ SIT (Cont):

**(10) (10A)** Navigation filter displays and controls for TACAN azimuth (TAC AZ) and range (RNG), drag altitude (DRAG H), and air data transducer assembly altitude (ADTA H) are provided. (For GPS, see **(11)** below.) For each parameter, the output from its selection filter minus the composite NAV state vector estimate of that data forms the residual (RESID). The ratio (RATIO) of actual residual to the maximum allowable residual is displayed in the RATIO column. If the RATIO is less than one, the data pass the update edit test and are incorporated into the state vector. A status column to the right of the RATIO contains a '↓' when the parameter has failed the update edit test a specified percentage of times (I-loaded). The '↓' disappears when the parameter passes the test a percentage of the time (I-loaded). Items 19, 22, and 25 are used to allow navigation to select data to be used if they pass the edit test. Items 20, 23, and 26 inhibit (INH) the incorporation of measured data into the state vector. Items 21, 24, and 27 override the edit and force (FOR) the navigation filter to use the data if the data are being processed. An '\*' appears next to any item (19 thru 27) that has been selected. The display is initialized with items 20, 22, and 26 selected. Items 19 thru 21, 22 thru 24, and 25 thru 27 are mutually exclusive. The residual and ratio data fields are blanked for a parameter if its data are not being processed.

**(10B)** The TACAN channel of the ground station that TAC 1, 2, and 3 are locked onto or attempting to lock onto is displayed. The sign of the channel is determined by the X/Y mode select bit, X mode being positive. TACAN azimuth and range are displayed for the TACANs in absolute values only. A status column is provided for the azimuth and range for each TACAN. A blank in the column indicates normal operation and a '↓' is displayed to indicate loss of lock or a commfault, a manual deselection using item 31, 32, or 33, a self-test is in progress, or a power loss. If any of these conditions is reversed, the '↓' is blanked.

**(11)** This line displays GPS data. RESID is the difference between the GPS and navigational software position vectors. RATIO is the ratio of RESID to the maximum allowable position residual (determined pre-flight). If RATIO is greater than or equal to one, the GPS data is considered to have failed its edit test, and a '↓' will be displayed beside the RATIO parameter.

NOTE: The GPS velocity residual is also ratio-tested (though not displayed due to lack of CRT space), and if it is greater than or equal to one it will also drive a '↓' next to RATIO. So it is possible to have a '↓' next to RATIO even though the displayed RATIO (range) is within limits, i.e., less than 1.

If no GPS data are available, both the GPS RESID and RATIO data fields will be blanked.

Item 42 (AUTO) allows navigation to automatically select GPS data if it passes its edit test (RATIO < 1 and no '↓'); item 43 (INH) prevents navigation from updating the state vector with GPS data, but still allows RESID and RATIO data to be processed and displayed; item 44 forces navigation to use GPS data in updating the state vector regardless of whether it has passed its edit test. An '\*' is displayed next to the item selected. These three items are mutually exclusive.

**(12)** Items 28 thru 30 provide control over the source of air data parameters input to GNC. Item 28 (AUT) provides auto transition from NAV-derived air data to ADTA. Item 29 (INH) inhibits the ADTA data. Item 30 (FOR) forces the use of ADTA data. These three items are mutually exclusive and an '\*' is driven next to the selected item. The display is initialized with item 28 selected.

**(13)** GPS-derived azimuth and range to the selected RUNWAY. A '↓' is displayed next to either variable if the software determines it is invalid. The fields are blanked if no GPS data are available.

### \*PROGRAM NOTES

**(2)** BFS Horizontal Situation Display Predictors Incorrect. During BFS MM304, if a roll angle of 90 degrees or more is performed below 200K feet, the horizontal situation display's 20, 40, and 60 second predictors will indicate a turn in the opposite direction. The crew should ignore the HSD predictors when the roll angle is greater than or equal to 90 degrees. (DR B08297)

	1										2										3										4										5									
	1	2	3	4	5	6	7	8	9	0	1	2	3	4	5	6	7	8	9	0	1	2	3	4	5	6	7	8	9	0	1	2	3	4	5	6	7	8	9	0	1	2	3	4	5	6	7	8	9	0
1	XXXX / 051 /										OVERRIDE										XX X										DDD / HH : MM : SS																			
2																															BFS DDD / HH : MM : SS										(5)									
3	ABORT MODE										ELEVON										FILTER										ATMOSPHERE																			
4	TAL 1X										AUTO 17X										NOM 20X										NOM 22X																			
5	ABORT 3X										FIXED 18X										ALT 21X										N POLE 23X																			
6	THROT MAX 4X										SSME REPOS										19 XXX										S POLE 24X										(6)									
7	ABT 50X																																																	
8	NOM 51X										IMU DES ATT										AA										RGA SURF										(10)									
9	PRPLT DUMP										1 25X X										LRU DES										DES DES																			
10	XXX ICNCT 5 XXXX										2 26X										1 31X										35X 39X										(8)									
11	OMS DUMP										3 27X										2 32X										36X 40X																			
12	ARM 6X																				3 33X										37X 41X																			
13	START 7X										ET SEP										4 34X										38X 42X																			
14	STOP 8X										AUTO 28X																																							
15	9 QUAN / SIDE XXX										SEP 29X																				ROLL MODE																			
16	QMS DUMP TTG XXX																														WRAP MODE 45 XXX										(9)									
17	AFT RCS 13 XXX										ET UMB DR																				COMM XXXX										(12)									
18	14 TIME XXX										CLOSE 30X																				TDRS 46X																			
19											VENT DOOR CNTL																				STDN-HI 47X																			
20	FWD RCS 15 XXX										OPEN 43X XX																				STDN-LO 48X										(7)									
21	16 TIME XXX										CLOSE 44X XX																				SGLS 49X																			
22																																																		
23																																																		
24																																																		
25																																																		
26																																																		
27																																																		
28																																																		
29																																																		
30																																																		
31																																																		
32																																																		
33																																																		
34																																																		
35																																																		
36																																																		
37																																																		
38																																																		
39																																																		
40																																																		
41																																																		
42																																																		
43																																																		
44																																																		
45																																																		
46																																																		
47																																																		
48																																																		
49																																																		
50																																																		
51																																																		
52																																																		
53																																																		
54																																																		
55																																																		
56																																																		
57																																																		
58																																																		
59																																																		
60																																																		
61																																																		
62																																																		
63																																																		
64																																																		
65																																																		
66																																																		
67																																																		
68																																																		
69																																																		
70																																																		
71																																																		
72																																																		
73																																																		
74																																																		
75																																																		
76																																																		
77																																																		
78																																																		
79																																																		
80																																																		
81																																																		
82																																																		
83																																																		
84																																																		
85																																																		
86																																																		
87																																																		
88																																																		
89																																																		
90																																																		
91																																																		
92																																																		
93																																																		
94																																																		
95																																																		
96																																																		
97																																																		
98																																																		
99																																																		
100																																																		

(1) **OVERRIDE.** A GNC SPEC (SPEC 51) available in BFS OPS 1, 3, and 6. Provides the following capabilities: selection of the desired switch mode for (2) ABORT, (8) ET SEP, and (9) ET UMB DR switches; (3) enable/inhibit the OMS/RCS ICNCT function, the OMS dump, and the (4) AFT and FWD RCS dumps; (5) select the elevon schedule, body bending filter, and the entry atmospheric model in OPS 3 and control the SSME drag chute repositioning sequence; (6) selection/deselection of an IMU LRU; (7) open/close vent doors during OPS 3 and 6; (10) selection/deselection of the accelerometer (AA), orbiter Rate Gyro Assembly (RGA), and aerosurface (SURF) feedback. (11) WRAP MODE. It allows the crew to enable or inhibit the flight control system wraparound mode. Execution is allowable only in OPS 3 and at any other time will result in an 'ILLEGAL ENTRY' message. (12) COMM allow the crew to (re)configure the communications systems to modes reqd to support the current phase of flight.

(2) **ABORT MODE** (items 1 thru 3) provides a backup for selecting a TAL abort in MM103 and MM104 or an ATO abort in MM102, MM103, and MM104 and then initiating the abort. Selections indicated by an '\*'. These options are available in MM102 and MM103. Execution of these items during any other mode results in an 'ILLEGAL ENTRY' message as does execution of item 3 before item 1 or 2. The display is initialized with these items deselected (no '\*'). Item 4 (THROT MAX), Item 50 (THROT ABT), and item 51 (THROT NOM) allow the crew to change the SSME upper throttle level limit to one of three I-Loaded values. These three item entries are mutually exclusive and the selected item shall be indicated by an asterisk (\*).

(3) **PRPLT DUMP.** Items 5 thru 9 allow the crew to enable, inhibit, and control manual or automatic abort dumps in OPS 1, 3, and 6. Item 5 (ICNCT) is used to enable (ENA)/inhibit (INH) the OMS/RCS interconnect function. The interconnect is initialized enabled in OPS 1 and inhibited in OPS 3. If a manual dump is initiated, the status of the OMS/RCS interconnect will be determined by item 5. If item 5 is enabled when an intact abort is selected, item 5 will be set to an I-loaded value by the Abort Control Sequence. If item 5 is inhibited when the abort is selected, item 5 will remain inhibited. Whenever the Abort Control Sequence or OMS/RCS Interconnect Sequence terminates the OMS/RCS interconnect, item 5 will be reset (INH).

'CPLT' will be displayed to the right of 'XXX ICNCT 5' when the OMS/RCS interconnect is completed and will return to blank when the return to normal configuration is completed.

Items 6 (ARM) and 7 (START) allow the crew to manually initiate a dump. Item 8 (STOP) inhibits or terminates an automatic dump, or terminates a manual dump. An '\*' indicates selection.

## OVERRIDE (Cont):

The display is initialized with items 6 thru 8 reset (no '\*'). Execution of item 6 arms the dump and blanks the STOP '\*'. Item 7, which can only be executed when item 6 is showing an '\*', starts the dump. Executing item 8 will blank the ARM and START asterisks and stop the dump in progress. Any automatic dumps associated with an abort selection will be inhibited if an '\*' is present next to item 8.

Item 9 (QUAN/SIDE) allows the crew to enter an amount of propellant to be dumped, measured in percent quantity per side. Item 9 is initialized in OPS 1 to a software calculated quantity based on a manual dump I-load; thereafter, item 9 reflects crew input. If an intact abort is selected, the OMS dump time will be set to an I-loaded value by the Abort Control Sequence, based on the abort selected, and item 9 will be computed and displayed as a function of this I-load. In OPS 3, item 9 is initialized to the last value from OPS 1, or to an automatic dump value based on abort selection.

If a new value is entered into item 9 while any OMS dump is in progress, the dump will be based on the new value. If the quantity entered via item 9 exceeds the MAX QUAN ENTRY, the entry will be rejected and an 'ILLEGAL ENTRY' message will be displayed.

Items 5, 8, and 9 are legal entries in all major modes in OPS 1, 3, and 6 except MM104 thru MM106. Items 6 and 7 are legal entries in MM103, MM304, and MM601 only.

OMS DUMP TTG (time-to-go) displays the amount of time remaining, in seconds, to dump OMS propellant, whether or not a dump is in progress. In OPS 1, the OMS dump time is initialized to the manual OMS dump time I-load value; any changes thereafter to OMS DUMP TTG will be a function of quantity input by the crew via item 9, an I-loaded value based on the intact abort selected, or the completion of an OMS/RCS interconnect. The OMS DUMP TTG value reflects dump time using a scale factor based on a two OMS engine flow rate. During an OMS/RCS interconnect with RCS jets commanded on, the OMS DUMP TTG computation will be adjusted by a scale factor to reflect the additional RCS flow rates. OMS DUMP TTG decrements as dumping occurs until it reaches zero at which time the dump is terminated.

- (4) Items 13 and 15 are used in MM304, MM602, and MM603 to ENA/INH the aft and forward RCS dumps, respectively. The dumps are initialized enabled and thereafter will reflect crew inputs, except in OPS 3 when the TAL flag is not set; then they are initialized inhibited. Items 14 and 16 are initialized with I-loaded dump times in seconds in OPS 1, and if the TAL flag is set, in OPS 3. In OPS 6 they carry over the last values from OPS 1. Depending on the number of jets involved during a dump, these times will decrement accordingly. In OPS 3 with the TAL flag not set, the times are initialized to 0. MM304 RCS dumps may be enabled by putting in a nonzero dump time via items 14 and 16, and enabling the dumps via items 13 and 15, respectively.
- (5) ENTRY FCS. Items 17 and 18 allow the crew to command the descent DAP to use an AUTO or FIXED elevon schedule. The display is initialized with the AUTO schedule selected. The FIXED schedule will be used for aero PTIs. For flights with no scheduled PTIs, the aft schedule will be I-loaded into the FIXED slot for use during a no yaw jet entry. Items 20 and 21 can be used to choose the nominal (NOM) or alternate (ALT) body bending filter. The display is initialized with the nominal filter (item 20) selected. However, if OPS 3 is entered from OPS 1, the ALT body bending filter will be selected. If OPS 3 is entered from OPS 0, the NOM filter is selected. An '\*' indicates selection during operation in OPS 3. Items 17 and 18 are mutually exclusive, as are items 20 and 21; selection of one automatically deselects the other. In OPS 1 or OPS 6, the '\*' is blanked as the elevon schedule and body bending filter are I-loaded independent of crew input. These items are legal in OPS 3 only, and will result in an 'ILLEGAL ENTRY' message if executed in any other OPS.

Item 19 (SSME REPOS) allows the crew to enable (ENA)/inhibit (INH) the repositioning of the SSMEs which occurs automatically in MM304. The SSME REPOS is initialized blank until OPS 3 when it is set to ENA; thereafter, the status field will reflect crew inputs. Item 19 is legal in MM301, MM302, MM303, and MM304 only and will result in an 'ILLEGAL ENTRY' message if executed in any other major mode.

Items 22, 23, and 24 allow the crew to select the atmospheric model used by entry navigation. The display is initialized with the nominal model selected, item 22 (NOM). Items 23 (N POLE) and 24 (S POLE) select north polar and south polar models, respectively. These items are mutually exclusive, with an '\*' displayed next to the currently active model.

These items are legal in OPS 3 only; execution in OPS 1 or 6 will have no effect.

VERRIDE (Cont):

- (6) IMU DES (items 25 thru 27) provide select/deselect for the three IMUs. Display is initialized with the status blank indicating selection of all three. Execution of the item number causes deselection, indicated by an '\*'. A subsequent reexecution of the item causes a reselect and the '\*' is blanked. IMU deselection status is also shown on the GNC SYS SUMM 1 display. The IMU attitude (ATT) shall display which IMU (1, 2, or 3) is selected for use as an attitude source. It shall be blank prior to AS11A event (i.e., Attitude Processor is inactive).

- (7) VENT DOOR CNTL. Items 43 (OPEN) and 44 (CLOSE) provide manual capability to command the forward and aft compartment vent doors, and/or all vent doors, depending on the Major Mode these items are executed in. These items are mutually exclusive. Attempting to execute a command while an operation is in progress will result in an 'ILLEGAL ENTRY' message.

An asterisk is displayed immediately adjacent to an item after it is either manually executed or commanded by an auto control sequence. An 'OP' or 'CL' character string is displayed adjacent to the asterisk after the executed sequence has completed. This character string will continue to be displayed until a subsequent item is commanded, at which time it will be blanked. During a manual or auto sequence, the 'OP' or 'CL' character string field will be blanked.

Item 43 (OPEN) is legal only in OPS 3, and in MM602 and MM603. Item 44 (CLOSE) is legal only in MM301 thru MM304, and MM602; and is legal in MM305 and MM603 after the ROLL-OUT FLAG is set true. Execution of these items in any other Major Mode will result in an 'ILLEGAL ENTRY' message; in addition, the command will be rejected. Execution of these items pre-BFS ENGAGE will result in a 'BFS ILLEGAL PRE-ENG' message; the command will also be rejected.

A manual CLOSE (item 44) executed in MM301 will cause all doors to be commanded closed. Subsequently, left vent doors 1/2 and 8/9 will automatically be reopened. In MM302 and MM303, executing an item 43 or 44 will command all vent doors open or closed, respectively. A manual OPEN (item 43) in MM304 will cause only the left vent doors 1/2 and 8/9 to open; in MM602, all doors will open. A manual CLOSE in MM304 (or MM602) will command all vent doors closed. All vent doors are commanded closed, regardless of their configuration, at the transition to MM304 (or MM602). Finally, a manual OPEN (item 43) executed in MM305 will command all vent doors open.

Upon transition to MM304 or 602, all vent doors are automatically commanded closed with the asterisk moving to the CLOSE position if it was not already there due to previous operations. Also in MM304, only left vents 1/2 and left vents 8/9 will OPEN in response to an item 43 (OPEN) command with the asterisk moving to the OPEN position.

At Mach 2.4, the vent door software will automatically open the vent doors and the asterisk will move to the OPEN position.

- (8) ET SEP (items 28 and 29) provides a backup for initiating the AUTO MODE and ET separation in MM102 thru MM106 and MM601. Execution during any other mode or pre-BFS ENGAGE results in an 'ILLEGAL ENTRY' message. Display is initialized with the items deselected (no '\*').
- (9) ET UMB DR (item 30) provides a backup for closing the ET umbilical doors in MM104, MM105, and MM106. Execution during any other mode or pre-BFS ENGAGE results in an 'ILLEGAL ENTRY' message. Display is initialized with this item deselected (no '\*').
- (10) LRU AA/RGA/SURF. Items 31 thru 34, 35 thru 38, and 39 thru 42 provide for deselection/ reselection of accelerometer assembly (AA), rate gyro assembly (RGA), and aerosurface feedback (SURF) transducer strings as candidates for the selection filter.

This display is initialized in OPS 1 and on transition from OPS 0 to OPS 3 with all of the LRUs selected (no '\*'). Execution of any of these items will deselect the corresponding LRU; an '\*' is displayed next to those LRUs which have been deselected. Execution of any of these items with an '\*' present reselects the corresponding LRU and blanks the '\*'. The status of items 31 thru 42 are maintained across the transition from OPS 1 to OPS 3/6.

At least one LRU has to be selected for each area (AA, RGA, and SURF); attempting to deselect the last selected LRU will result in an 'ILLEGAL ENTRY' message.

- (11) WRAP MODE. Item 45 allows the crew to enable or inhibit the flight control system wraparound mode. Execution is allowable only in OPS 3 and at any other time will result in an 'ILLEGAL ENTRY' message. The status field to the right of item 45 is blank until OPS 3 transition, after which it toggles between 'ENA' or 'INH' based on crew selection. If a TAL abort has been declared, it will be initialized to INH. When the wrap mode is active, 'ACT' will be displayed.

OVERRIDE (Cont):

- (12)** COMM. Items 46 through 49 allow the crew to re(configure) the communications systems to modes reqd to support the current phase of flight. Item 46 will configure the comm systems to communicate with TDRS. Item 47 will configure the comm systems to communicate with STDN ground sites in high power mode while item 48 has the same configuration except for low power mode. Item 49 will configure the comm systems to communicate with SGLS ground sites. The current mode is displayed with an '\*' next to the item. An indication of the forward link to the orbiter is located next to the COMM label. This telemetry will indicate "LOCK" if the NSP is processing a good forward link, otherwise it will blank.



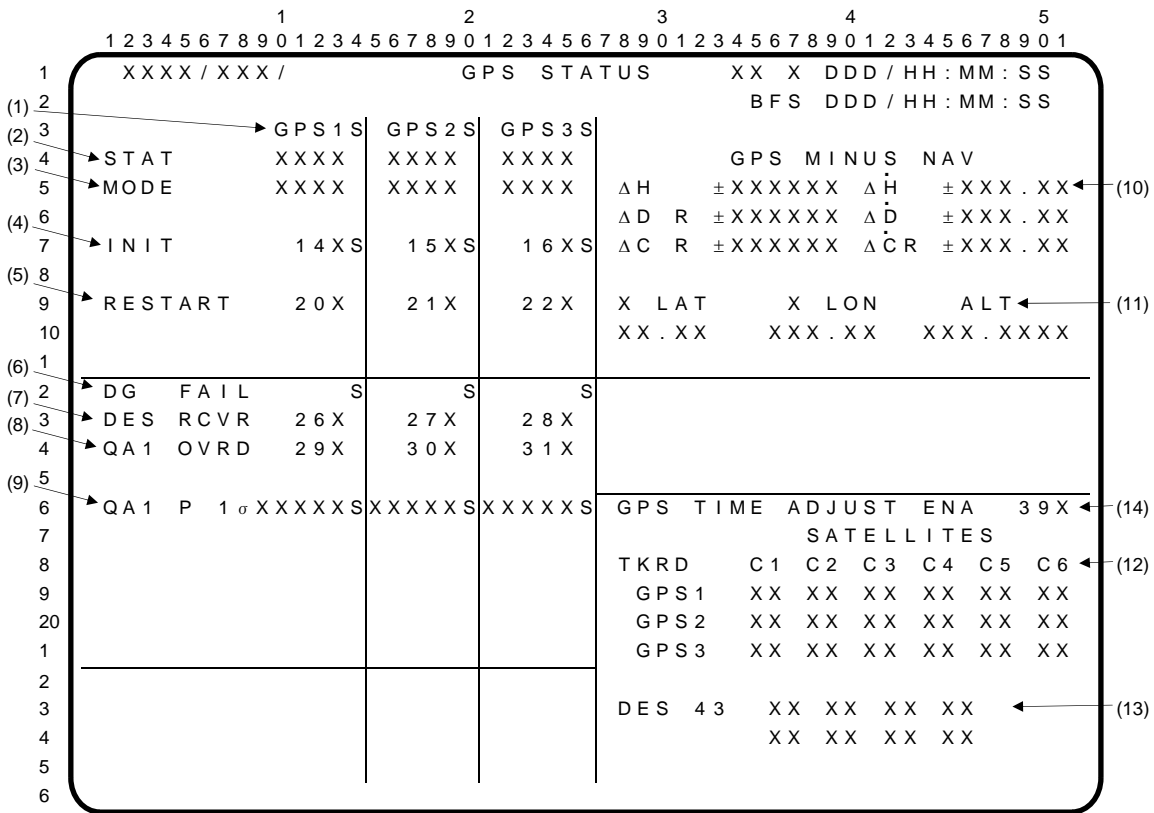

GPS STATUS is available in BFS GNC OPS 1, OPS 3, and OPS 6. It provides insight into GPS systems operation and health, as well as GPS-estimated position.

- (1) The GPS parameter status indicator shall display the navigation status of each receiver. The determination of which symbol to display for each receiver shall be made by examining the NAV variables GPS1IND, GPS2IND, and GPS3IND according to the table below.

DISPLAY	MESSAGE DESCRIPTION
blank	Receiver data available for NAV use
↓	Receiver data not available for NAV
?	Receiver data available for NAV use but rejected due to a receiver-to-receiver miscomparison

- (2) The STAT. This field displays the status of the GPS unit. If the GPS is operating normally, the field is blanked; otherwise, one of the following status codes will be displayed double overbright:

DISPLAY	MESSAGE DESCRIPTION
NI	Receiver is not installed
M	Communication Fault
RPF	Receiver/processor failure
BATT	GPS battery low
DGF	GPS data good failure
(blank)	Nominal operation – No GPS related anomaly

If a receiver processor failure (RPF) occurs, a CLASS 3 alarm will be annunciated by GAX. 'RPF' will be displayed double overbright. STAT is active regardless of whether the corresponding receiver is installed.

GPS STATUS (Cont):

- (3) The MODE. This field displays the GPS receiver's current operating mode:

Display	Message Description
INIT	Initialization mode
TEST	Self-Test mode
INS	Inertial Navigation System submode
PVA	Position, Velocity, Acceleration navigation submode
STA	Prelaunch Standby navigation submode
(blank)	Receiver is not in an operating mode

The MODE field shall display the current operating modes of the GPS receivers. There are three basic operating modes for the receiver: 1) Initialization, 2) Test, and 3) Navigation. The Navigation mode has three submodes: aided (INS), unaided (PVA), and Prelaunch Standby (STA). When any one of the GPS receivers is not in the Initialization mode, Test mode or one of the three recognized Navigation submodes, the MODE field for that GPS receiver shall be blanked.

- (4) INIT. Items 14, 15, and 16 provide the capability to command the initialization of a GPS receiver. An '\*' shall be displayed while initialization operations are in progress and while the receiver remains in the INIT mode. To the right of each INIT mode command status field is the command result field, which displays the most-recently commanded initialization attempt. If the initialization was successful, the result field shall be blanked. If the initialization failed, the result field will display a down arrow '↓'. Commanding INIT mode while the receiver is in the INIT mode will result in an 'ILLEGAL ENTRY' message. The receiver will remain in the INIT mode until commanded to S/TEST or NAV mode, at which time the '\*' will be removed.

For uninstalled receivers or when the BFS is not engaged, executing item 14, 15, or 16 will result in an 'ILLEGAL ENTRY' message.

- (5) RESTART. Items 20, 21, and 22 provide the capability to command each GPS receiver to restart its navigation filter. This option is available only when the receiver is in the INS NAV submode, indicated by 'INS' being displayed in the MODE field. An 'ILLEGAL ENTRY' message will be generated if the RESTART command is entered and the receiver is not in the INS NAV submode. An '\*' shall be displayed in the associated item field while the filter restart operations are in progress for that receiver and the '\*' will be removed upon receiver completion of the restart. If the receiver is in the S/TEST or INIT modes, commanding a receiver filter restart will result in an 'ILLEGAL ENTRY' message.

For uninstalled receivers, executing item 20, 21, or 22 will result in an 'ILLEGAL ENTRY' message.

- (6) DG FAIL. The DG FAIL status indicator shall display each GPS receiver's assessment of its own navigation state data validity. If the data good flag is OFF for a particular GPS receiver, a '↓' shall be displayed in the status indicator field corresponding to that receiver. If the data good flag is ON for a particular GPS receiver, its corresponding status indicator shall be blanked.

- (7) DES RCVR. Items 26, 27, and 28 provide the capability for each receiver to be deselected or reselected (toggle) for use by the GPS selection filter. Deselection is indicated by an asterisk "\*" adjacent to the DES item number. A blank indicates that the associated receiver has not been deselected. If the GPS receiver is manually deselected on either the PASS GPS STATUS DISPLAY or HORIZ SIT DISPLAY (3 GPS receivers installed), it does not need to be manually deselected on the BFS GPS STATUS because these item entries are DK listened.

- (8) QA 1 OVERRIDE. Items 29, 30, and 31 are used to force a given receiver's state to be a candidate for GPS state vector selection even though that state may have failed the QA1 threshold test. An '\*' is displayed if the override has been selected. QA 1 data continues to be calculated for a GPS receiver even if it has been selected for a QA 1 OVERRIDE.

GPS STATUS (Cont):

- (9) QA1 P1 $\sigma$  This field displays the Figure of Merit (FOM) or estimate of position error for each receiver. The FOM is related to the error as follows:

FOM integer	Position error (P), one sigma (1 $\sigma$ ) [feet]
0	(blank)
1	75
2	175
3	250
4	325
5	650
6	1650
7	3275
8	16400
9	99999

The FOM data from the GPS Receiver State Processing Principal Function will be blank when the receiver is not in NAV mode (i.e., in TEST or INIT mode) or when the GPS NAV data used by the GPS Receiver State Processing Principal Function are not valid.

If the FOM exceeds a pre-mission determined I-Load tolerance, a '↓' shall be driven in the appropriate parameter status indicator field next to the displayed FOM value and displayed double overbright. If the receiver state estimate fails the QA1 FOM quality assessment check, it is excluded as a candidate from the GPS state vector selection process.

If a particular GPS receiver's estimate of position error has passed the I-Loaded threshold test for an I-Loaded number of consecutive cycles, the parameter status indicator field for the P 1 $\sigma$  field corresponding to that particular GPS receiver shall be blank.

The corresponding fields for uninstalled receivers will remain blank.

- (10) GPS MINUS NAV. This section displays the components of the position and velocity vector differences between the selected GPS state estimate and the orbiter navigation filter state estimate in UVW coordinates: altitude ( $\Delta H$ ), downrange ( $\Delta DR$ ), and crossrange ( $\Delta CR$ ) for both position and velocity. Units are ft and ft/sec for position and velocity, respectively. The data fields are blanked when no GPS state is available.
- (11) GEODETIC COORDINATES. In MM304, 305, 602, and 603, altitude is displayed with units of kilo-feet. All other modes will display nautical miles.

This section displays the geodetic coordinates of the selected GPS state: altitude (ALT), latitude (LAT), and longitude (LON). Altitude is displayed in nautical miles. Latitude is displayed in degrees from the equator with an 'N' or 'S' displayed in the field before the LAT title for northern ( $LAT \geq 0$ ) or southern ( $LAT < 0$ ) hemisphere. Longitude is displayed in degrees from the Greenwich meridian with an 'E' or 'W' displayed in the field before the LON title if the orbiter is east ( $LON \geq 0$ ) or west ( $LON < 0$ ) of the Greenwich meridian, respectively.

The data fields are blanked when no GPS state is available.

- (12) SATELLITES TRACKED. This section shall display the GPS satellites being tracked by each receiver. Up to a maximum of six receiver channels can be displayed. If the receiver has less than six channels, the data will be blanked for the nonexistent channels. The order of the satellite number displayed reflects a one-to-one correspondence to the receiver channel tracking that satellite. Values range from 'blank' (no satellites being tracked) to 1 through 63.

The corresponding fields for uninstalled receivers will remain blank.

## GPS STATUS (Cont):

- (13)** DESELECT SATELLITES. Item entries 43 to 50 allow the crew to deselect satellites, valid satellite ID's being 1 to 63, as candidates for selection by the GPS receivers by building, based on Item Entries, a derived health status word. The '+' delineator deselects satellites and the '-' delineator removes satellites from being deselected as described below. As an example, 'ITEM 43 + 23 EXEC' will indicate to all GPS receivers that satellite ID 23 should not be used as a candidate for selection. If another satellite was previously deselected by item entry 43, an 'ILLEGAL ENTRY' message will be generated, the displayed data is unchanged and no change to deselected satellites occurs. If this satellite, ID 23 in this example, is currently deselected by another Item Entry, one of item entries 44 to 50 in this example, an 'ILLEGAL ENTRY' message will be generated, the displayed data is unchanged and no change to deselect satellites occurs.

'ITEM 43 – 23 EXEC' will indicate to all GPS receivers that satellite 23 should once again be considered as a candidate for selection. If item Entry 43 previously deselected satellite 23, then 'ITEM 43 – 23 EXEC' will result in a blank being displayed, and satellite 23 being available for selection. If satellite 23 is not currently deselected by item Entry 43, then an 'ILLEGAL ENTRY' message will be generated, the displayed data is unchanged and there is no change to deselected satellites.

Entry of satellite number of 0, less than - 63, or greater than + 63 will cause an 'ILLEGAL ENTRY' message to be issued. All satellites are initialized as available for selection. Satellite Deselection information for item entries 43 to 50 shall be maintained in the GNC major function base.

For the BFS, the satellite deselect option will only be necessary for satellites that are deselected in the PASS in OPS 2, 8, or 9. BFS will DK-listen for satellite deselections in OPS1, 3, and 6.

- (14)** GPS TIME ADJUST ENABLE. Item 39 enables a GPS time adjustment which is to be executed in the event of MTU failure. This item entry will bias the GPS time to force the GPS age-of-aiding from the GPCs to be equal to GPC\_GPS\_TARGET (typically 50 ms in BFS). This time adjustment will be made at every announced reset of the GPS aiding state, which occurs every 60 seconds.

This item entry is illegal in OPS 1 and MM 601.

BFS OPS G3 (ENTRY)

PAGE

OPS 3011	XXXXX MNVR YYYYY	.....(SEE GNC, OPS G1, PAGE	3-7)
OPS 3041	ENTRY TRAJ 1	.....	5-24
OPS 3041	2	.....	5-26
OPS 3041	3	.....	5-26
OPS 3041	4	.....	5-27
OPS 3041	5	.....	5-27
OPS 3051	VERT SIT 1	.....(SEE GNC, OPS G3, PAGE	3-64)
OPS 3051	2	.....(SEE GNC, OPS G3, PAGE	3-67)
DISP 18	GNC SYS SUMM 1	.....(SEE BFS, OPS G1, PAGE	5-10)
DISP 19	2	.....(SEE GNC, OPS G2, PAGE	3-24)
SPEC 50	HORIZ SIT	.....(SEE BFS, OPS G1, PAGE	5-12)
SPEC 51	OVERRIDE	.....(SEE BFS, OPS G1, PAGE	5-15)
SPEC 55	GPS STATUS	.....(SEE BFS, OPS G1, PAGE	5-19)

OPS G3  
(ENTRY)

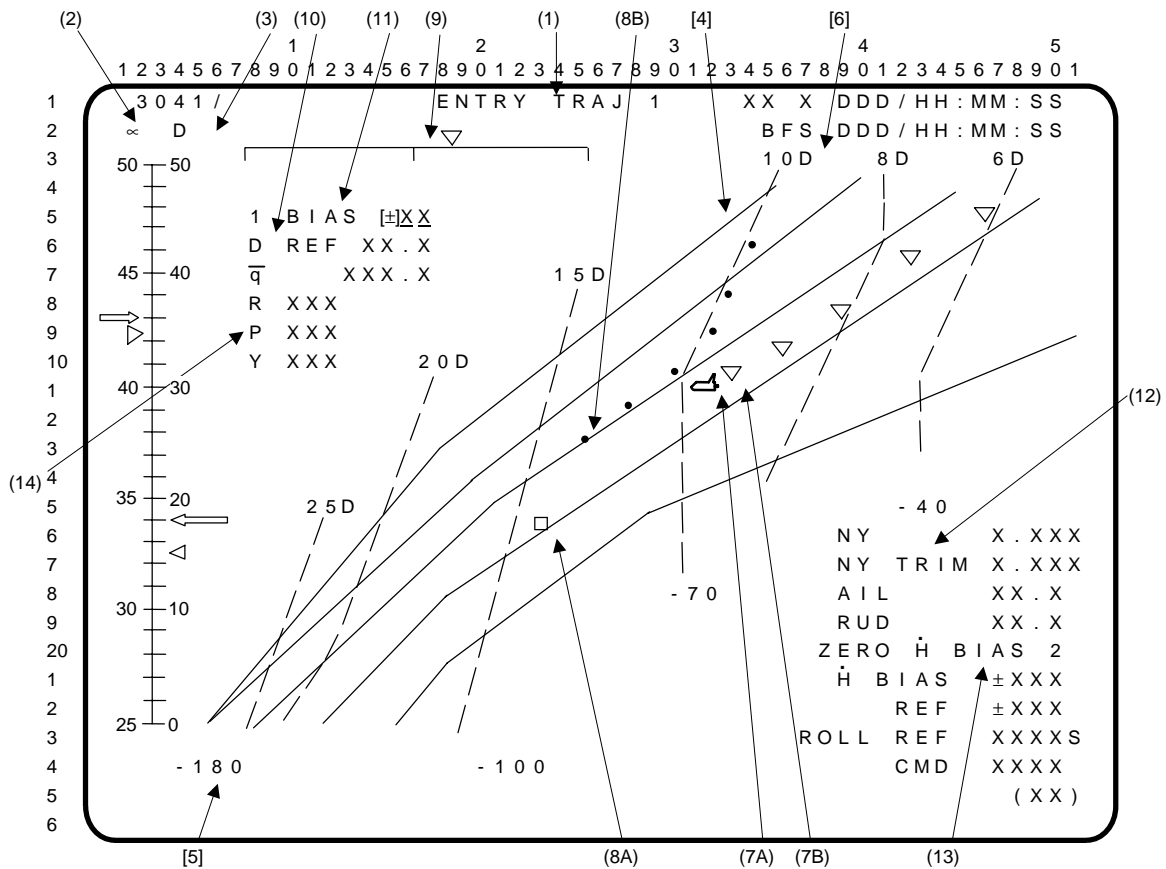

Note: [ ] denotes trajectory dependent data.

- (1) ENTRY TRAJ 1. A Guidance, Navigation, and Control (GNC) Operational Sequence (OPS) display of entry conditions with relative velocity from 24 kfps to 18 kfps. Called via OPS transition from MM303 to MM304 (crew keyboard entry 'OPS 304 PRO'). Includes (2) Angle of Attack ( $\infty$ ) tape scale and symbols; (3) drag (D) tape scale and symbols; [4] trajectory guidelines; [5] nominal altitude rates; [6] constant nominal drag acceleration lines; (7) the orbiter's current location and previous locations; (8) the orbiter reference location and previous locations computed by guidance; (9) phugoid scale; (10), (12), and (14); and; (11) and (13) control items.
- (2)  $\infty$ . Dynamic symbols representing commanded  $\infty$  ( $\rightarrow$ ) and actual  $\infty$  ( $\triangleright$ ) move along the  $\infty$  tape scale (scale range is l-loaded). The symbols flash when they reach the off-scale position, and the  $\triangleright$  flashes if actual and commanded  $\infty$  differ by more than two degrees.
- (3) D. Dynamic symbols representing commanded D ( $\leftarrow$ ), and actual D ( $\triangleleft$ ) move along the D tape scale (scale range 0 to 50  $\text{fps}^2$ ).
- [4] Nominal trajectory guidelines (solid lines).
- [5] Nominal altitude rates correspond to the altitude rates required to guide the shuttle trajectory between the guidelines when the actual drag acceleration is matched to the nominal drag value.
- [6] Nominal constant drag acceleration lines (dashed lines) are labeled at the top with the drag value the line represents.
- (7) (7A) The dynamic orbiter symbol () is located on the plot using relative velocity (~24 to 18 kfps) and RANGE (~4000 to 1000 nm).  
 (7B) Trailers ( $\nabla$ ) are left by the orbiter every 28.8 seconds on the plot to show the trend of the actual trajectory.

ENTRY TRAJ 1 (Cont):

- (8) **(8A)** The dynamic guidance symbol ( $\square$ ) is located on the plot using relative velocity and range computed by entry guidance. When the guidance has converged to a good solution, the  will be inside the  $\square$ .
- (8B)** Trailers ( $\bullet$ ) are left by the  $\square$  every 28.8 seconds on the plot to aid in monitoring of the convergence of the primary guidance (15.36 sec for ENTRY TRAJ 3, 4, 5).
- (9) Phugoid scale. Displays roll error based on achieving a biased reference drag.
- (10) D REF and  $\bar{q}$ . Data are displayed for the biased reference drag (D REF) in  $\text{fps}^2$ , and dynamic pressure ( $\bar{q}$ ) in psf.
- (11) Item 1 provides a data entry to bias the reference drag (D REF).
- (12) NY, NY TRIM, AIL, RUD,  $\dot{H}$  BIAS,  $\dot{H}$  REF, ROLL REF, and ROLL CMD. Data are displayed for lateral acceleration (NY) in g's, lateral acceleration trim (NY TRIM) in g's, aileron trim (AIL) in deg, rudder trim (RUD) in deg, guidance-computed altitude reference term ( $\dot{H}$  BIAS) in fps, reference body roll angle (ROLL REF) in deg, and commanded body roll angle (ROLL CMD) in deg. ('AIL' and 'RUD' values will not be displayed when BFS is in the preengaged state.)
- (13) Execution of item 2 zeroes the  $\dot{H}$  BIAS computed by guidance.
- (14) BFS-computed roll, pitch and yaw errors are displayed prior to BFS engage for comparison with PASS-driven ADI error needles. Each error value is preceded by one of the following characters: 'U', 'D', 'L', or 'R'. These indicate the fly-to direction of that error. If the roll error is 100 degrees or greater, an overflow indicator of 'R > >' or 'L > >' is displayed for a right or left fly-to error, respectively. These errors and signs are not displayed after BFS engage.

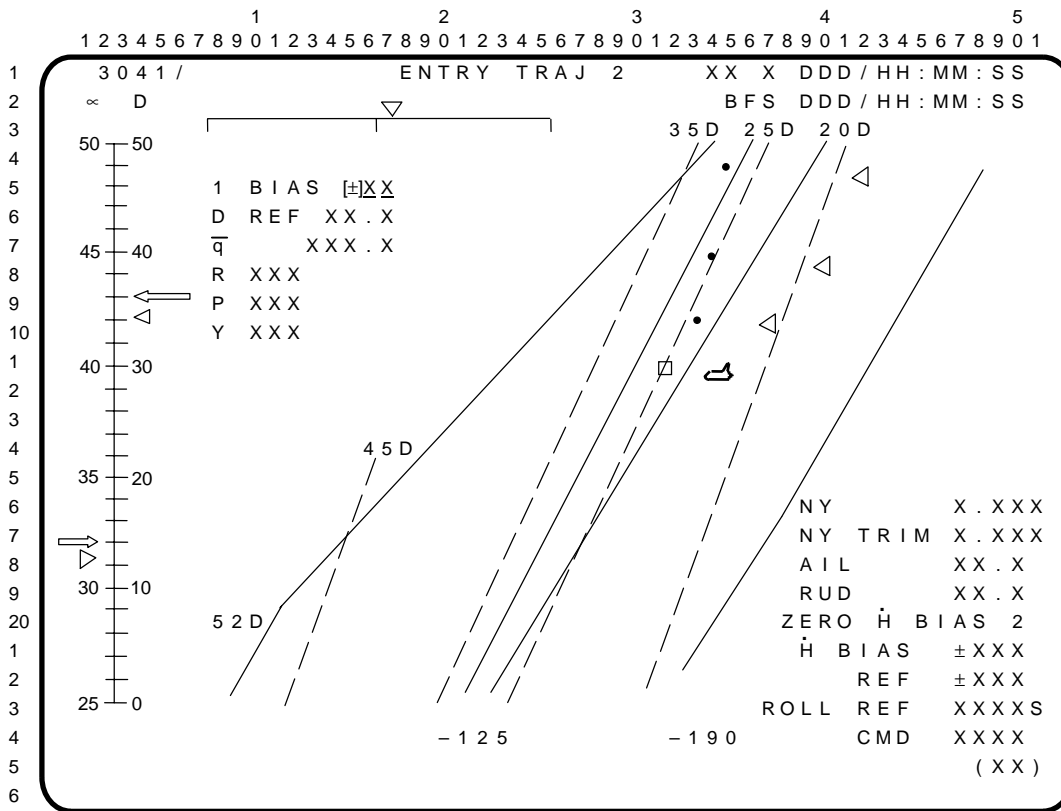

ENTRY TRAJ 2. A GNC OPS display of entry conditions with relative velocity from 19 to 14 kfps (approximately) and range-to-go from 1500 to 500 nm (approximately). See ENTRY TRAJ 1 for a description of the data on the display.

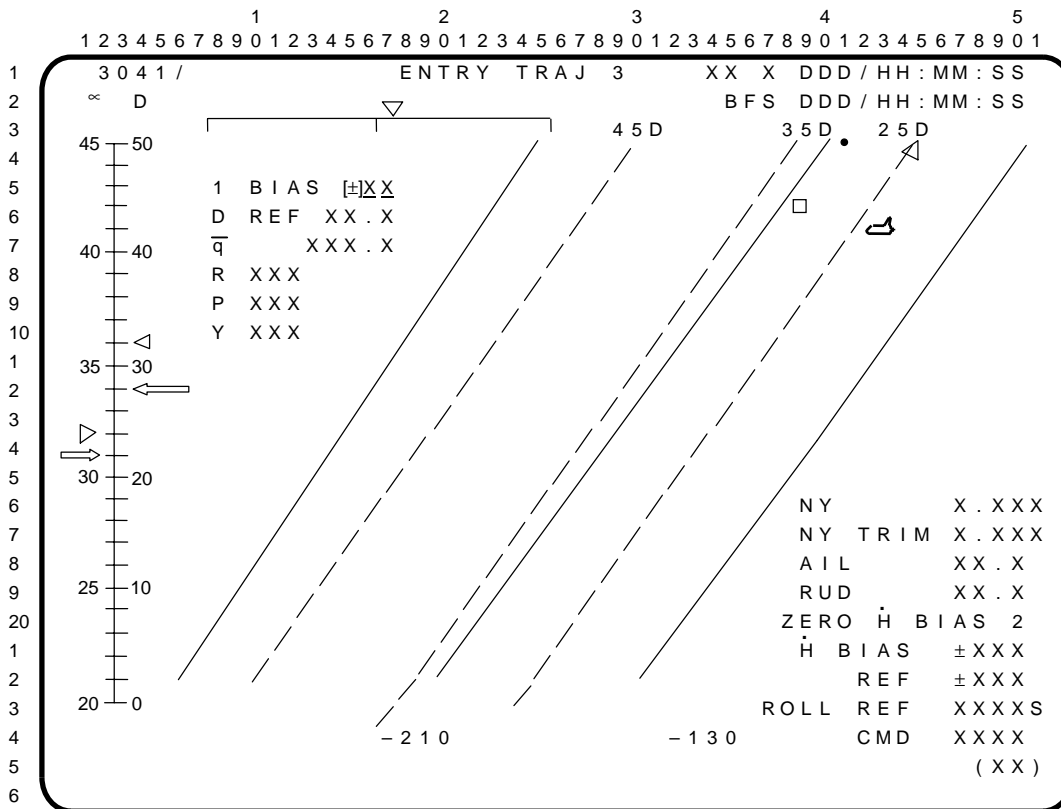

ENTRY TRAJ 3. A GNC OPS display of entry conditions with relative velocity from 14 to 10 kfps (approximately) and range-to-go from 700 to 350 nm (approximately). See ENTRY TRAJ 1 for a description of the data on the display.



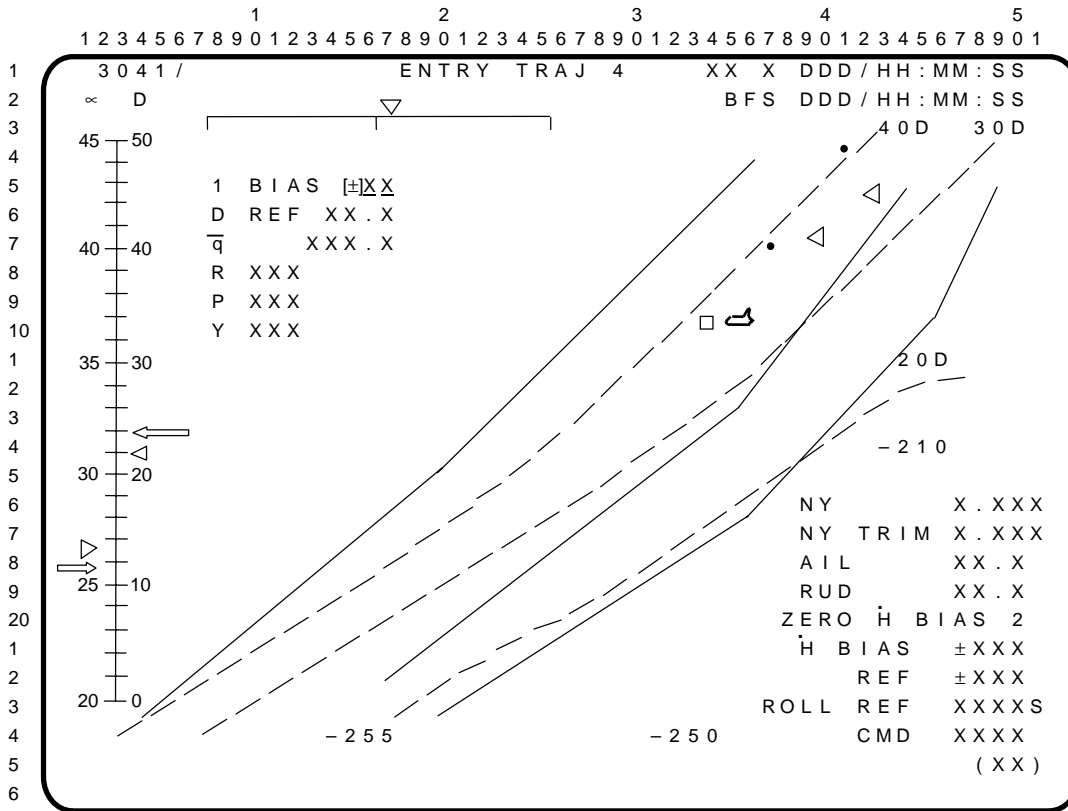

ENTRY TRAJ 4. A GNC OPS display of entry conditions during the high-energy portion of the transition phase. It is forced up automatically when the ENTRY TRAJ 3 passes out of range in OPS 3, or a PRO is performed from the ENTRY TRAJ 3 display in OPS 3. See ENTRY TRAJ 1 for a description of the data on the display.

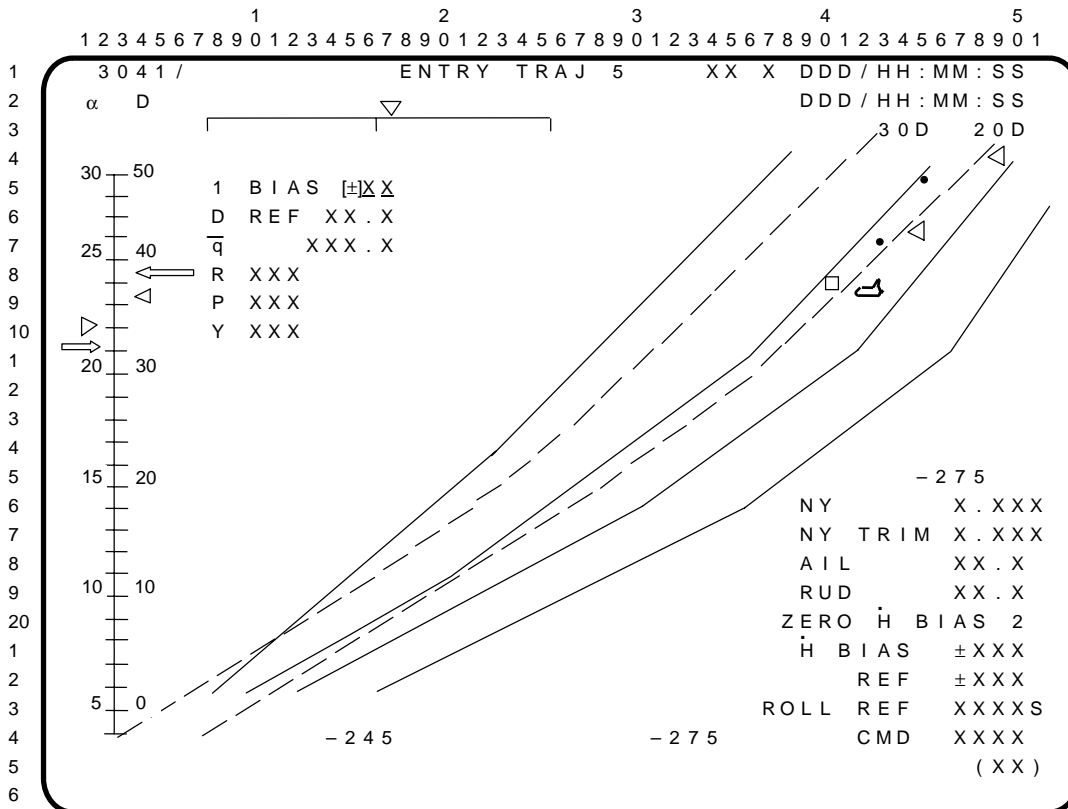

ENTRY TRAJ 5. A GNC OPS display of entry conditions during the low-energy portion of transition phase. See ENTRY TRAJ 1 for a description of the data on the display.

This Page Intentionally Blank

BFS OPS G6 (ABORTS)

OPS G6  
(ABORT)

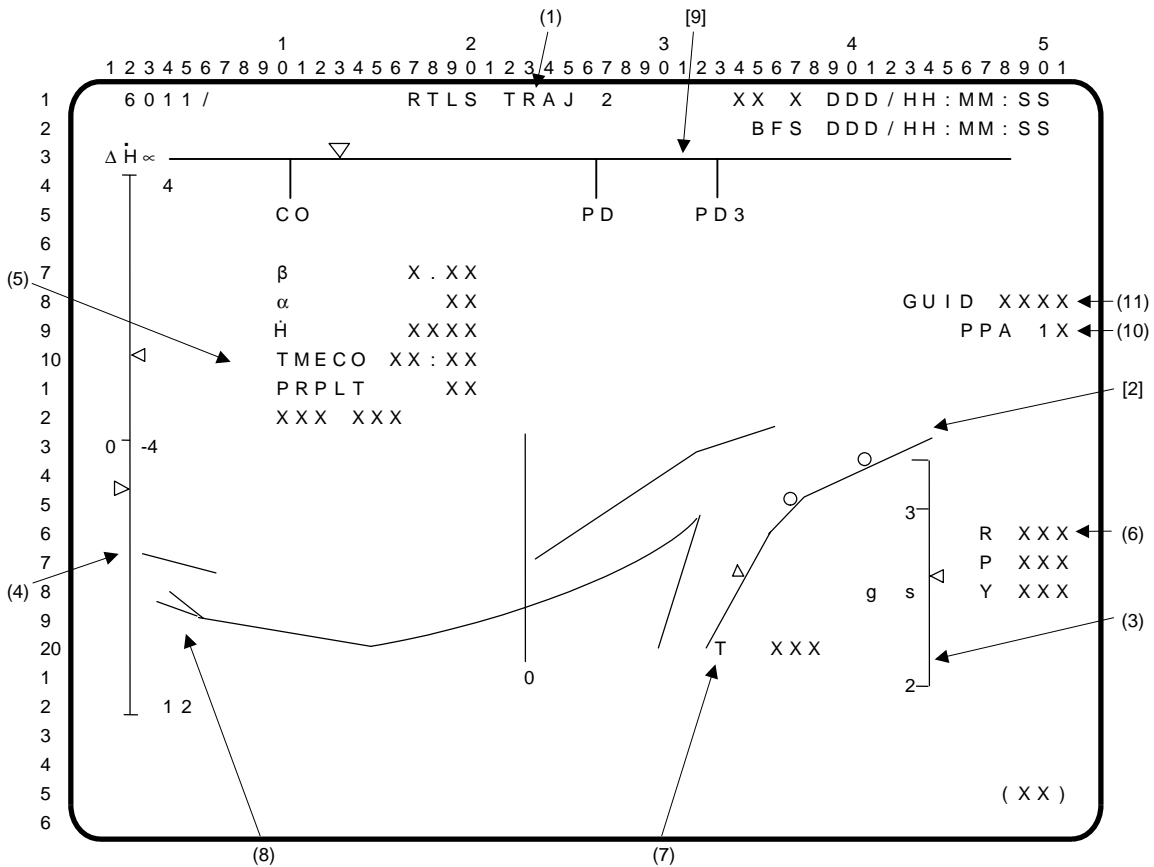

Note: [ ] denotes trajectory-dependent data.

- (1) The RTLS TRAJ 2 display is driven during an RTLS abort in MM601. It provides information to the crew on trajectory, loads, attitude, and critical guidance, trajectory, and attitude parameters.
- [2] The mission-dependent central plot is an altitude vs. horizontal component of relative velocity. Current vehicle state is indicated by a moving triangle. Predicted states for 30 and 60 seconds in the future are shown by circles. The outside line represents the nominal ascent profile. The inside line is for an engine out at lift-off. A vertical line intersects the curved lines where horizontal relative velocity is zero.
- (3) The g's scale is the total load factor in g's. The triangle indicator flashes if the load factor is 3 g's or greater.
- (4) The scale on the left indicates pitch angle of attack ( $\alpha$ ) and altitude change rate ( $\Delta \dot{H}$ ).
- (5) Predicted time of MECO (TMECO) from guidance is displayed, as are yaw angle of attack ( $\beta$ ), pitch angle of attack ( $\alpha$ ), altitude rate ( $\dot{H}$ ), percent propellant remaining in the ET (PRPLT), and 'SEP INH' when the ET SEP inhibit discrete is set.
- (6) BFS-computed roll, pitch, and yaw errors are displayed prior to BFS engage for comparison with PASS-driven ADI error needles. Each error value is preceded by one of the following characters: 'U', 'D', 'L', or 'R'. These indicate the fly-to direction of that error. If the roll error is 100 degrees or greater, an overflow of 'R >>' or 'L >>' is displayed for a right or left fly-to error, respectively. These errors and signs are not displayed after BFS engage.
- (7) The commanded SSME throttle setting (T) is indicated in percent.
- (8) Upper line is  $\bar{q} = 2$  (altitude vs. velocity line which, if the vehicle state is on or below this line,  $\bar{q} > 2$ ). Lower line is  $\bar{q} = 10$ . If vehicle state is below this line,  $\bar{q} > 10$  PSF.
- [9] Scale across the top is delta range ( $\Delta R =$  glide range potential minus present range to the landing site in nm). Powered pitchdown (PD) nominally occurs at MECO -20 sec. Three engine pitchdown (PD3) is also shown.
- (10) Item 1 (PPA) selection forces the BFS into the powered pitcharound (PPA) phase during a RTLS abort; an asterisk (\*) displayed at item 1 indicates that the BFS has started PPA.
- (11) GUID indicates the status of the guidance solution prior to a powered pitcharound. Prior to RTLS selection (MM601), this field is blanked. Once RTLS is selected, GUID INIT will be displayed until initialization is complete. As the vehicle progresses to the powered pitcharound point, GUID displays the percent deviation of the predicted final mass from the RTLS mass target. GUID INHB will be displayed if the powered pitcharound has been delayed due to an attitude violation or if guidance is unconverged. Once the powered pitcharound begins, GUID PPA will appear, and the field will be frozen.

OPS G6  
(ABORT)

BFS SM OPS 0

SM OPS 0

	1	2	3	4	5
	12345678901	2345678901	2345678901	2345678901	2345678901
1	0001/	/	THERMAL	XX X	DDD/HH:MM:SS
2				BFS	DDD/HH:MM:SS
3	HYD	SYS TEMP	BDYFLP RD/SB	L OB	L IB R IB R OB
4		PRIME	±XXXX ±XXXX	±XXXX ±XXXX	±XXXX ±XXXX
5		STBY 1	±XXXX ±XXXX	±XXXX ±XXXX	±XXXX ±XXXX
6			BRAKE PRESS		
7		HYD SYS 1/3	XXXXX XXXXS	XXXXX XXXXS	XXXXX XXXXS
8			2/3 XXXXS	XXXXX XXXXS	XXXXX XXXXS
9	HTR TEMP	L/A	R/B	FREON LOOP 1	2
10	PRPLT			ACCUM QTY	XXXX XXXS
1	POD	SSSSSSS	SSSSSSS	RAD OUT T	XXXX XXXS
2	OMS CRSFD	SS		H2O SUP P	XXXX
3	EVAP			TIRE PRESS	
4	HI LOAD	SSS		MG LEFT	RIGHT
5	TOP DUCT	SS		IB XXXS	XXXX XXXS XXXS
6	NOZ	S	S	OB XXXS	XXXX XXXS XXXS
7	FDLN	SSSS	SSSS	NG XXXS	XXXX XXXS XXXS
8					
9	HYD BLR/HTR	S	S	S	
20	APU				
1	GG/FU PMP HTR	SSSSS	SSSSS	SSSSS	
2	TK/FU LN HTR	SSSSSSS	SSSSSSS	SSSSSSS	
3	PUMP/VLV	SS	SS	SS	
4					
5					
6					(XX)

The THERMAL display is a BFS display (OPS 0001) which provides the crew data on the hydraulic system, heater status, Freon/water loop parameters, tire pressure status, and brake pressure readings.

**PARAMETER CHARACTERISTICS**

CRT NAME	UNITS	DISPLAYED RANGE	STATUS INDICATORS				
			M	H	L	↑	↓
HYD SYS TEMP (24 Parameters) [1]	degF	-75 to +300	M	H	L		↓
BRAKE PRESS	psia	0 to 3000	M	H	L	↑	
HTR TEMP: PRPLT POD [2]			M	H	L	↑	↓
OMS CRSFD [2]			M	H	L	↑	↓
EVAP HI LOAD [2]			M	H	L	↑	↓
TOP DUCT [2]			M	H	L	↑	↓
NOZ [2]			M	H	L	↑	↓
FDLN [2]			M	H	L	↑	↓
HYD BLR/HTR [2]			M	H	L	↑	↓
APU: GG/FU PMP HTR [2]			M	H	L	↑	↓
TK/FU LN HTR [2]			M	H	L	↑	↓
PUMP/VLV [3]			M	H	L	↑	
FREON LOOP: ACCUM QTY	percent	0 to 100	M	H	L		↓
RAD OUT T	degF	25 to 130	M	H	L	↑	↓
H2O SUP P	psia	0 to 50	M	H	L	↑	↓
TIRE PRESS (12 Parameters)	counts	0 to 500	M	H	L	↑	↓

**REMARKS**

- [1] No CRT message or tone with '↓'.
- [2] A blank display field denotes normal operation. '↑' and '↓' indicate heater or thermostat failures in a series heater line. Level detection limits are shown on SM displays. 'M', 'H', and 'L' denote data transfer or sensor failures unrelated to heater control. CRT titles are aligned to panel switches needed to select different heater circuits.

SM OPS 0

THERMAL (Cont):

- HTR TEMP: PRPLT POD – panel A14; RCS/OMS HEATERS, LEFT/RIGHT POD
- OMS CRSFD – panel A14; RCS/OMS HEATERS, CRSFD LINES
- EVAP HI LOAD – panel L1; HI LOAD DUCT HTR
- TOP DUCT – panel L1; TOPPING EVAPORATOR HEATER, DUCT
- NOZ – panel L1; TOPPING EVAPORATOR HEATER, L-NOZZLE-R
- FDLN – panel L2; FLASH EVAP FEEDLINE HEATER
- HYD BLR/HTR – panel R2; BOILER CNTR/HTR
- APU: GG/FU PMP HTR – panel A12; APU HEATER, GAS GEN/FUEL PUMP
- TK/FU LN HTR – panel A12; APU HEATER, TANK/FUEL LINE

**[3]** A blank display field denotes normal operation. An '↑' indicates an overheated APU fuel pump and/or valve module. Level detection limits are shown on SM displays. 'M', 'H', and 'L' denote data transfer or sensor failures. The FU PMP and GGVM HTSK T status indicator is to remind the crew that the affected APU cannot be restarted until it cools down below the limit. Both the FU PMP and GGVM HTSK have class 0 FDAs (no crew annunciation other than '↑' arrow).

PARAM #	PNL #	THERMAL DISPLAY				(X/X = L/A or R/B)
		HTR	TEMP	X/X		
1-7	A14	PRPLT			SSSSSSS	
8-9	A14	OMS	CRSFD		SS	
10-12	L1	EVAP			SSS	
13-14	L1	HI	LOAD		SS	
15	L1	TOP	DUCT		S	
16-19	L2	NOZ			SSSS	
		FDLN			X	(X=1, 2, or 3)
20	R2	HYD	BLR/HTR		S	
		APU				
21-25	A12	GG/FU	PMP	HTR	SSSSS	
26-32	A12	TK/FU	LN	HTR	SSSSSSS	
33-34		PUMP / VLV			SS	

PARAMETER

- |  |  |
|--|--|
| <ol style="list-style-type: none"> <li>1. POD DRN PNL 1 L(R)</li> <li>2. VERN PNL 1 L(R)</li> <li>3. OX DRN PNL 1 L(R)</li> <li>4. 2 L(R)</li> <li>5. ENG SERV PNL L(R)</li> <li>6. FDLN OX AFT L(R)</li> <li>7. FU L(R)</li> <li>8. OMS CRSFD DRN OX L</li> <li>9. R</li> <li>10. EVAP HI LOAD INBD DUCT</li> <li>11. OUTBD DUCT</li> <li>12. NOZ</li> <li>13. TOPPING FWD</li> <li>14. AFT</li> <li>15. NOZ L(R)</li> <li>16. FDLN FWD A(B)</li> </ol> | <ol style="list-style-type: none"> <li>17. EVAP FDLN MID 1 A(B)</li> <li>18. MID 2 A(B)</li> <li>19. AFT A(B)</li> <li>20. W/B X BLR</li> <li>21. APU X GG BED</li> <li>22. INJ</li> <li>23. PUMP OUT</li> <li>24. GGVM SPLY LN</li> <li>25. PUMP BYP LN</li> <li>26. FEED LN</li> <li>27. PUMP IN</li> <li>28. TEST LN</li> <li>29. SERVICE LN</li> <li>30. PUMP DRN LN 1</li> <li>31. 2</li> <li>32. H2O LN INJ</li> <li>33. FU PUMP BDY</li> <li>34. GGVM HTSK</li> </ol> |
|--|--|

	1										2										3										4										5																			
	1	2	3	4	5	6	7	8	9	0	1	2	3	4	5	6	7	8	9	0	1	2	3	4	5	6	7	8	9	0	1	2	3	4	5	6	7	8	9	0	1	2	3	4	5	6	7	8	9	0										
1	XXXX/XXX/078										SM SYS SUMM 1										X										DDD/HH:MM:SS																													
2																					BFS										DDD/HH:MM:SS																													
3	SMOKE					1/A					2/B					DC VOLTS					1/A					2/B					3/C																													
4	CABIN					XX.XS					FC					XX.XS					XX.XS					XX.XS																																		
5	L/R FD					XX.XS					XX.XS					MAIN					XX.XS					XX.XS					XX.XS																													
6	AV BAY 1					XX.XS					XX.XS					ESS					XX.XS					XX.XS					XX.XS																													
7						2					XX.XS					XX.XS					A					B					C					A																								
8						3					XX.XS					XX.XS					CNTL 1					XXX.X					XXX.X					XXX.XX																								
9	CABIN																				2										XXX.X										XXX.X										XXX.XX									
10	PRESS					XX.XS															3										XXX.X										XXX.X										XXX.XX									
1	dP/dT					±.XXS																																																						
2	BU/EQ					±.XXS					±.XXS					AC																																												
3											VOLT										ΦA					XXXS					XXXS					XXXS																								
4											PPO2										X.XXS					X.XXS					ΦB					XXXS					XXXS					XXXS														
5											FAN ΔP										X.XXS					ΦC					XXXS					XXXS					XXXS																			
6											HX OUT T										XXXS					AMPS					ΦA					X.XS					X.XS					X.XS														
7											O2 FLOW										X.XS					X.XS					ΦB					X.XS					X.XS					X.XS														
8											N2 FLOW										X.XS					X.XS					ΦC					X.XS					X.XS					X.XS														
9	IMU FAN ΔP										X.XXS					FUEL CELL PH										XXS					XXS					XXS																								
20	ΔV FC1					FC2					FC3					AMPS										XXXS					XXXS					XXXS																								
1	SS1					XXXS					XXXS					XXXS					REAC VLV										XXS					XXS					XXS																			
2	SS2					XXXS					XXXS					XXXS					STACK T										XXXS					XXXS					XXXS																			
3	SS3					XXXS					XXXS					XXXS					EXIT T										XXXS					XXXS					XXXS																			
4	TOTAL AMPS					XXXXS					COOL P										XXS					XXS					XXS																													
5	KW					XXS					PUMP																																																	
6																																																			(XX)									

The SM SYS SUMM 1 display is an SM display (DISP 78) available in BFS SM OPS 0, which provides summary data on emergency, atmospheric (cabin), and electrical power distribution and generation parameters.

### PARAMETER CHARACTERISTICS

CRT NAME	UNITS	DISPLAYED RANGE	STATUS INDICATORS				
			M	H	L	↑	↓
SMOKE: CABIN	[1] mgm/M <sup>3</sup>	0 to 15	M	H	L	↑	↓
L/R FD	[1] mgm/M <sup>3</sup>	0 to 15	M	H	L	↑	↓
AV BAY 1,2,3	[1] mgm/M <sup>3</sup>	0 to 15	M	H	L	↑	↓
CABIN: PRESS	psia	0 to 20	M	H	L	↑	↓
dP/dT	[2] psi/min	+0.45 to -0.55	M	H	L		↓
BU	[2] psia	-.99 to +.99	M	H	L		↓
EQ	[3] psi/min	-.99 to +.99	M	H	L		↓
PPO2	pct	0 to 5	M	H	L	↑	↓
FAN ΔP	in H2O	0 to 8	M	H	L	↑	↓
HX OUT T	degF	+45 to +145	M	H	L	↑	↓
O2 FLOW	lbm/hr	0 to 5	M	H	L	↑	↓
N2 FLOW	lbm/hr	0 to 5	M	H	L	↑	↓
IMU FAN ΔP	in H2O	0.0 to +7.0	M	H	L	↑	↓
ΔV SS 1,2,3	mvdc	0 to 500	M	H	L	↑	↓
TOTAL: AMPS	amps	0 to 1500	M				
KW	kW	0 to 60	M				
DC VOLTS: FC	volts	0 to 40	M	H	L	↑	↓
MAIN	volts	0 to 40	M	H	L	↑	↓
ESS	volts	0 to 40	M	H	L	↑	↓
CNTL 1, 2, 3	[5] volts	0 to 40	M	H	L	↑	↓
AC: VOLT ΦA, ΦB, ΦC	volts	0 to 140	M	H	L	↑	↓
AMPS ΦA, ΦB, ΦC	amps	0 to 20	M	H	L	↑	↓
FUEL CELL: PH	[6] text	'blank' or 'PH'	M				↓
AMPS	amps	0 to 500	M	H	L	↑	↓
REAC VLV	[4] text	'CL' or 'OP'	M				↓
STACK T	degF	-75 to +300	M	H	L	↑	↓
EXIT T	degF	0 to 250	M	H	L	↑	↓
COOL P	psia	0 to 100	M	H	L	↑	↓
PUMP	text	'ΔP' or blank	M				↓



REMARKS

- [1]** The hardwired smoke emergency alert can also be initiated by smoke rate-of-increase (not shown on CRT). There is no software triggered emergency alert for smoke rate-of-increase.
- [2]** The dP/dT hardware status field shows an 'H' for an off-scale pressure leak (greater than -.5 psi/min). The BU dP/dT numerics blank out and the status shows an 'L' for the same condition.

Loss of power to the CABIN PRESSURE transducer will result in the CABIN PRESSURE going off-scale-low (0 psia) and the BU dP/dT will act similarly to an off-scale pressure leak, going to '-.99' psi/min then blanking out and leaving an 'L'. After a short time, the BU dP/dT will recede back to within limits and proceed to zero. This occurs since no delta pressure exists once CABIN PRESSURE has gone off-scale-low for a period of time. A similar phenomenon will occur if the CABIN PRESSURE transducer is repowered, in which case the BU dP/dT will then operate in an opposite, but similar, fashion.
- [3]** EQ dP/dT is the equivalent dP/dT at 14.7 for the current Cabin Pressure and dP/dT. EQ dP/dT parameter data is initiated at MM101 transition and displayed pre/post BFS engage. If either Cabin Press or dP/dT are missing, the last computed value of EQ dP/dT and 'M' are displayed. The EQ dP/dT field format range is  $\pm .99$ . If this range is exceeded, the last computed value of EQ dP/dT and either an 'H' or 'L' are displayed.
- [4]** Either H2 or O2 valve closed causes a '↓'.
- [5]** Each parameter is preceded/followed by an RPC trip status indicator. These indicators are located under the alpha column headers (A-B-C-A); they read '\*' if the associated RPC is OFF (blank otherwise). Examples: MNA AB1/CA1 RPC = OFF produces an '\*' for CNTL 1 under both the left and right A; MNB AB2/BC2 RPC = OFF produces an '\*' for CNTL 2 under the B; MNC BC3/CA3 RPC = OFF produces an '\*' for CNTL 3 under the C.
- [6]** 'PH' and '↓' appear when fuel cell pH is outside of normal range. I

	1									2									3									4									5																																																					
	1	2	3	4	5	6	7	8	9	1	2	3	4	5	6	7	8	9	1	2	3	4	5	6	7	8	9	1	2	3	4	5	6	7	8	9	1	2	3	4	5	6	7	8	9																																													
1	XXXX/XXX/079									SM SYS SUMM 2									XX X									DDD/HH:MM:SS																																																														
2																												BFS DDD/HH:MM:SS																																																														
3	CRYO TK									1									2									3									4									5									MANF1									MANF2																										
4	H2 PRESS									XXXXS									XXXXS									XXXXS									XXXXS									XXXXS									XXXXS									XXXXS																										
5	O2 PRESS									XXXXS									XXXXS									XXXXS									XXXXS									XXXXS									XXXXS									XXXXS																										
6	HTR T1									±XXXXS									±XXXXS									±XXXXS									±XXXXS									±XXXXS									±XXXXS									±XXXXS																										
7	T2									±XXXXS									±XXXXS									±XXXXS									±XXXXS									±XXXXS									±XXXXS									±XXXXS																										
8	APU									1									2									3									HYD									1									2									3																										
9	TEMP EGT									XXXXS									XXXXS									XXXXS									PRESS									XXXXS									XXXXS									XXXXS																										
10	B/U EGT									XXXXS									XXXXS									XXXXS									ACUM P									XXXXS									XXXXS									XXXXS																										
1	OIL IN									XXXXS									XXXXS									XXXXS									RSVR T									XXXXS									XXXXS									XXXXS																										
2	OUT									XXXXS									XXXXS									XXXXS																																																														
3	GG BED									XXXXS									XXXXS									XXXXS									QTY									XXXXS									XXXXS									XXXXS																										
4	INJ									XXXXS									XXXXS									XXXXS																																																														
5	SPEED %									XXXXS									XXXXS									XXXXS									W/B																																																					
6	FUEL QTY									XXXXS									XXXXS									XXXXS									H2O QTY									XXXXS									XXXXS									XXXXS																										
7	PMP LK P									XXS									XXS									XXS									BYP VLV									XXXXS									XXXXS									XXXXS																										
8	OIL OUT P									XXXXS									XXXXS									XXXXS																																																														
9	FU TK VLV																																																																																									
20	A T									XXXXS									XXXXS									XXXXS									THERM CNTL									1									2																																			
1	B T									XXXXS									XXXXS									XXXXS									H2O PUMP P									XXXXS									XXXXS																																			
2	AV BAY									1									2									3									FREON FLOW									XXXXS									XXXXS																																			
3	TEMP									XXXXS									XXXXS									XXXXS									EVAP OUT T									XXXXS									XXXXS																																			
4	FAN ΔP									X.XXS									X.XXS									X.XXS																																																														
5																																																																																										
6																																																																																										

The SM SYS SUMM 2 display is an SM display (DISP 79), available in BFS SM OPS 0, which provides the crew summary level data on cryogenics, auxiliary power units, hydraulics, water boilers, thermal control, and avionics cooling.

**PARAMETER CHARACTERISTICS**

CRT NAME	UNITS	DISPLAYED RANGE	STATUS INDICATORS				
			M	H	L	↑	↓
CRYO TANK: H2 PRESS	[1] psia	145 to 305	M	H	L	↑	↓
O2 PRESS	[1] psia	515 to 1015	M	H	L	↑	↓
HTR T1	degF	-425 to +475	M	H	L	↑	↓
T2	degF	-425 to +475	M	H	L	↑	↓
MANF 1,2: H2 PRESS	psia	0 to 400	M	H	L		↓
O2 PRESS	psia	0 to 1200	M	H	L		↓
APU: TEMP EGT	degF	0 to 1500	M	H	L	↑	
B/U EGT	degF	0 to 1500	M	H	L	↑	
OIL IN	degF	0 to 500	M	H	L	↑	↓
OUT	degF	0 to 400	M	H	L	↑	↓
GG BED	degF	0 to 500	M	H	L		↓
INJ	degF	0 to 1500	M	H	L		↓
SPEED %	percent	0 to 167	M	H	L	↑	↓
FUEL QTY	percent	0 to 100	M	H	L		↓
PMP LK P	[2] psia	0 to 50	M	H	L	↑	
OIL OUT P	psia	0 to 200	M	H	L	↑	↓
FU TK VLV A,B T	degF	0 to 250	M	H	L	↑	↓
AV BAY: TEMP	degF	45 to 145	M	H	L	↑	
FAN ΔP	[3] in H2O	0 to 5 or 0 to 8	M	H	L	↑	↓
HYD: PRESS	psia	0 to 4000	M	H	L		↓
ACUM P	psia	0 to 4000	M	H	L	↑	↓
RSVR T	degF	-75 to +300	M	H	L	↑	↓
QTY	percent	0 to 100	M	H	L	↑	↓
W/B: H2O QTY	percent	0 to 100	M	H	L		↓
BYP VLV	text	'BYP' or 'W/B' or 'blank'	M				
THERM CNTL: H2O PUMP P	psia	0 to 150	M	H	L		↓
FREON FLOW	lbm/hr	570 to 2600	M	H		↑	↓
EVAP OUT T	degF	25 to 130	M	H		↑	↓

SM SYS SUMM 2 (Cont):

REMARKS

- [1]** These pressures also appear at 'P' (O2/H2) on the CRYO SYSTEM (DISP 68) display and are used by the tank heater controller.
- [2]** Measured at fuel pump drain line and is representative of leak rate.
- [3]** All vehicles have been modified to be capable of using upgraded av bay fans in Av Bay 3a. These fans are larger than standard av bay fans to provide additional cooling to Av Bay 3a payloads; they are equivalent to cabin fans. These larger fans have a different  $\Delta P$  operating range and thus, different upper and lower FDA limits than those of nominal av bay fans. As of 05/18/04, there are no explicit plans to manifest the larger av bay fan on any upcoming flight.

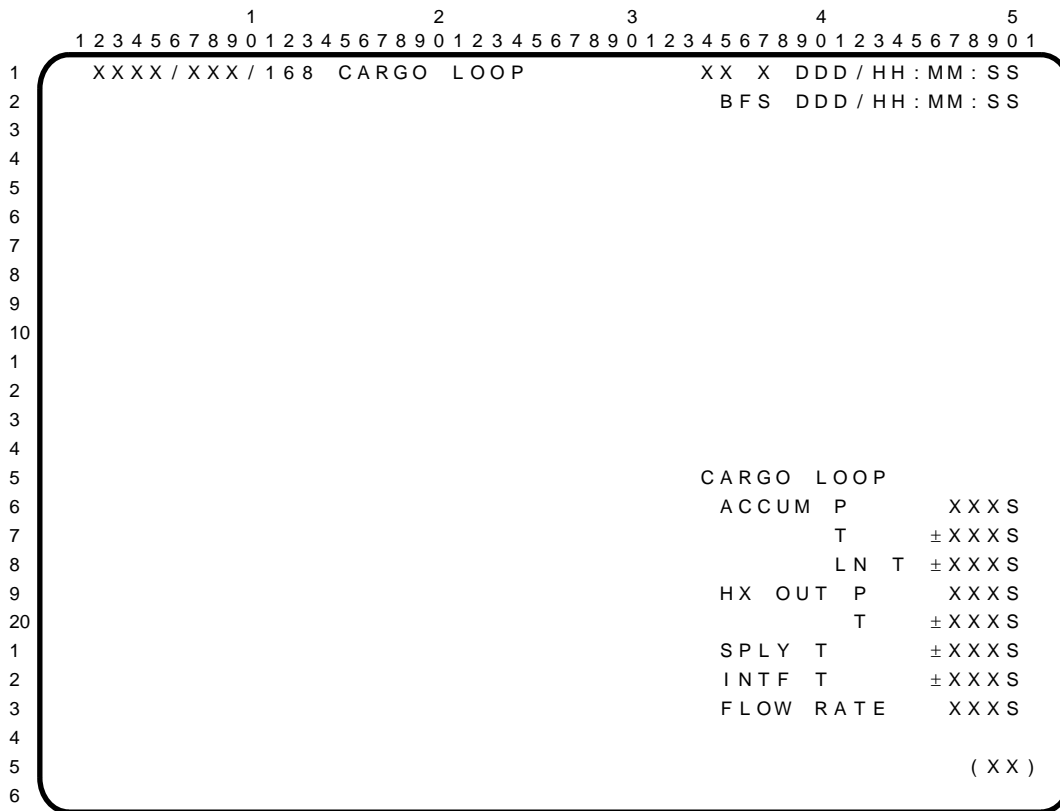

The CARGO LOOP display is an SM display (DISP 168), available in BFS SM OPS 0, which provides the crew summary level data on the cargo loop.

**PARAMETER CHARACTERISTICS**

CRT NAME	UNITS	DISPLAYED RANGE	STATUS INDICATORS				
			M	H	L	↑	↓
CARGO LOOP: ACCUM P	[1] psia	0 to 250	M	H	L	↑	↓
ACCUM T	[1] degF	0 to 250	M	H	L	↑	↓
ACCUM LN T	[1] degF	0 to 250	M	H	L	↑	↓
HX OUT P	[1] psia	0 to 267	M	H	L	↑	↓
HX OUT T	[1] degF	0 to 250	M	H	L	↑	↓
SPLY T	[1][2] degF	0 to 250	M	H	L	↑	↓
INTF T	[1][2] degF	0 to 250	M	H	L	↑	↓
FLOW RATE	[1][2] lbm/hr	160 to 800	M	H	L	↑	↓

**REMARKS**

- [1] For flights not involving an Active MPLM, the corresponding FDA limits for these parameters shall be set OSL/OSH.
- [2] For flights not involving an Active MPLM, the associated sensors will not be installed on the vehicle. Thus, the display values for these parameters will be essentially those associated with 0 PCM counts. For SPLY T and INTF T, the expected display value will be "-1L"; for FLOW RATE, the expected display value will be "160L." (Reference SASCB Action 10/09/03-01, 16-OCT-03.)

MULTIFUNCTION ELECTRONIC DISPLAY SYSTEM (MEDS) DISPLAYS

I

MAIN MENU TREE .....	6-3
OMS/MPS DISPLAY .....	6-4
HYD/APU DISPLAY .....	6-5
SPI DISPLAY .....	6-7
A/E PRIMARY FLIGHT DISPLAY (A/E PFD) .....	6-8
PRELAUNCH A/E PFD .....	6-22
ORBIT PRIMARY FLIGHT DISPLAY (ORB PFD) .....	6-24
SYSTEM STATUS DISPLAY WITH CST MENU .....	6-25
FILE PATCH ADDRESS DISPLAY .....	6-27
SYSTEM STATUS DISPLAY WITH IDP INTERACTIVE CST .....	6-28
FILE PATCH DISPLAY .....	6-29
PROG LOAD DISPLAY .....	6-30
FAULT SUMMARY DISPLAY .....	6-31

**MEDS DISPLAYS**

This Page Intentionally Blank

# MAIN MENU TREE

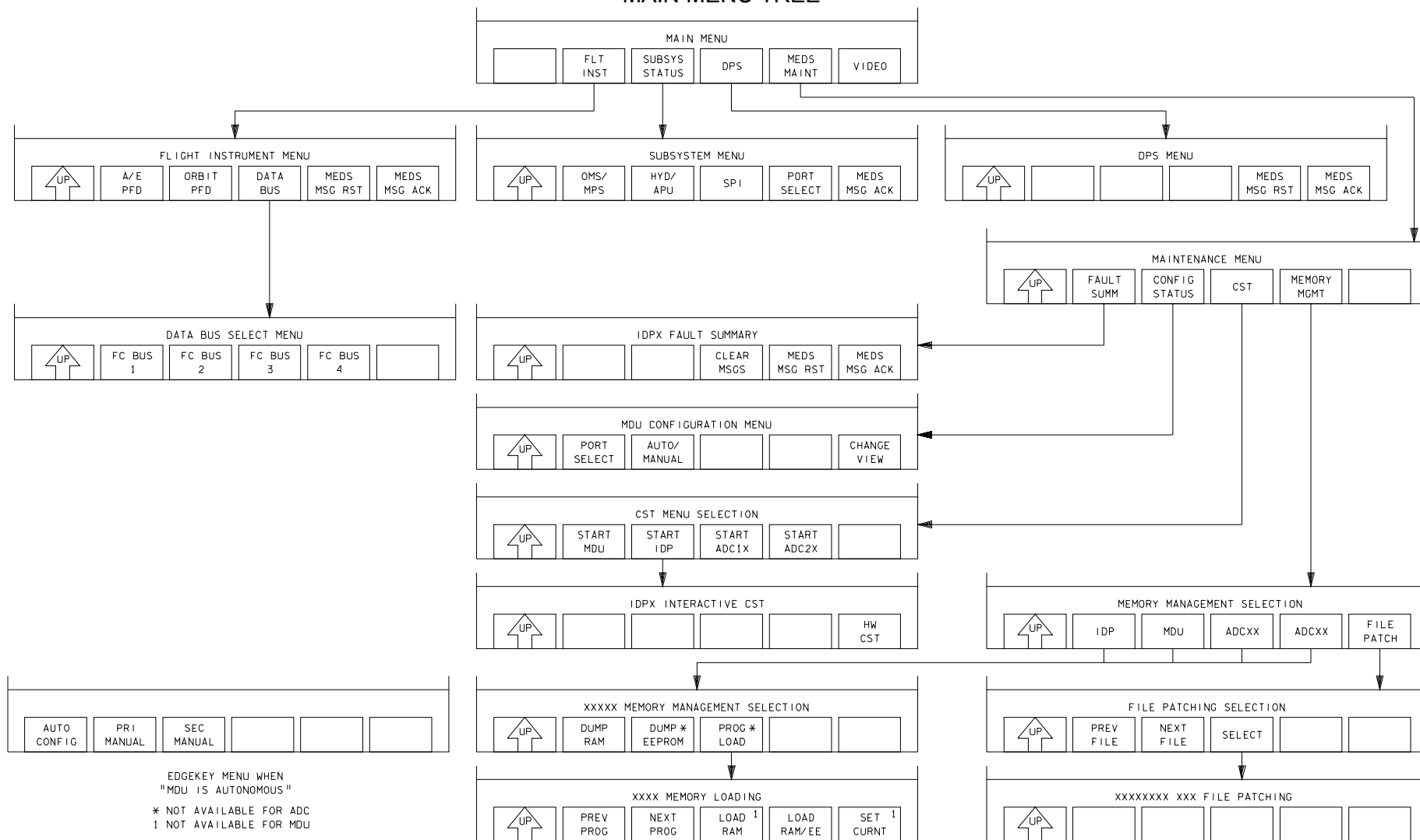

48017613\_121.PNL# 1

# OMS/MPS DISPLAY

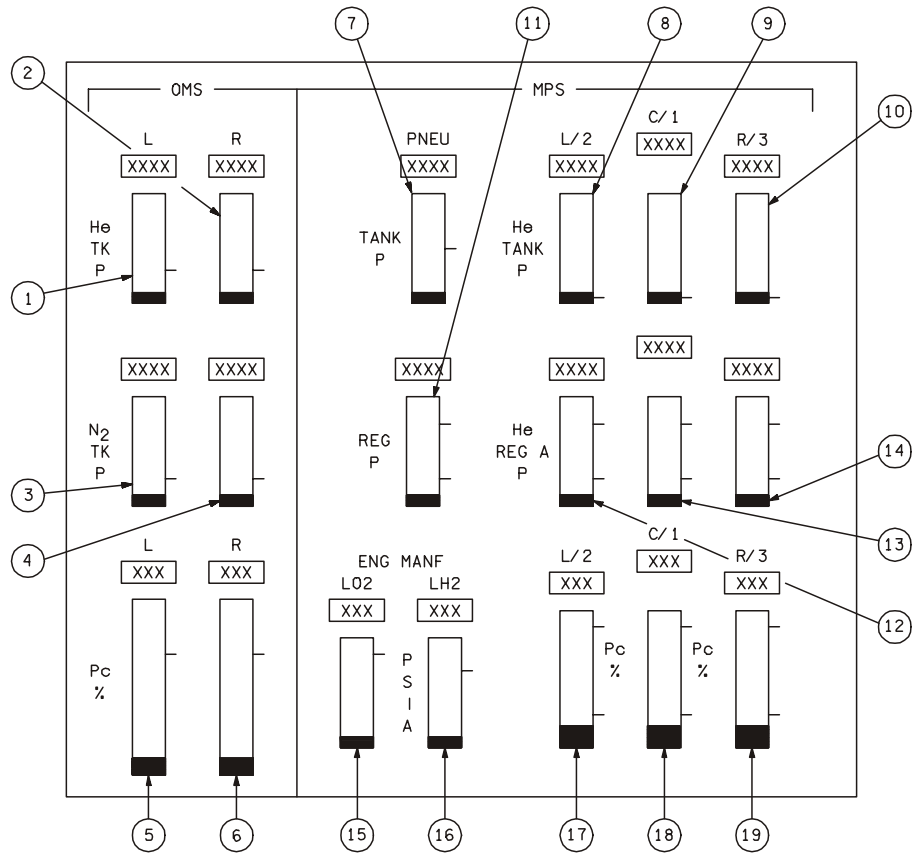

48017612\_101.PNL 3

NO.	DISPLAY PARAMETER	UNITS	METER DISPLAYED RANGE	DIGITAL READOUT READING	TICK LOCATION	STATUS COLORS			
						Black	Red	Green	White
1,2	L(R) OMS He TK PRESS meter	psia	0 to 5000	0 to 5000	1500		0-1499	1500+	
3,4	L(R) OMS N2 TK PRESS meter	psia	0 to 3000	0 to 3000	1200		0-1199	1200+	
5,6	L(R) OMS Pc meter	%	0 to 120	0 to 160%	80	0 - 3	4-79		80 +
7	PNEU He TK PRESS meter	psia	3000 to 5000	0 to 5000	3800		3000-3799	3800+	
8,9,10	L(C,R) ENG He TK PRESS meter	psia	1000 to 5000	0 to 5000	1150		1000-1149	1150+	
11	PNEU He REG PRESS meter	psia	600 to 900	0 to 1000	680, 810		600-679 or 811 +	680-810	
12,13,14	L(C,R) ENG He REG PRESS meter	psia	600 to 900	0 to 1000	680, 810		600-679 or 811 +	680-810	
15	LO2 ENG MANF PRESS meter	psia	0 to 300	0 to 300	249		250+	0-249	
16	LH2 ENG MANF PRESS meter	psia	0 to 100	0 to 100	65		66+	0-65	
17,18,19	L(C,R) ENG Pc meter	%	45 to 109	0 to 115%	67, 104		45-64		65 +



## HYD/APU DISPLAY

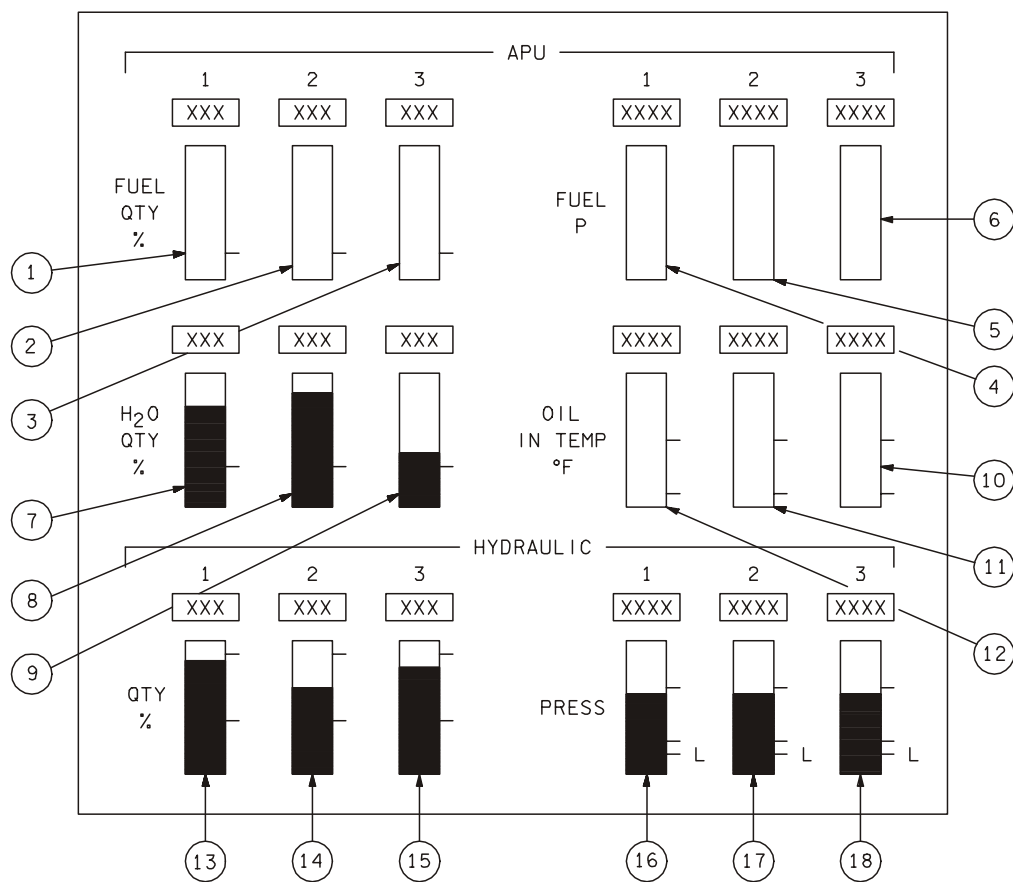

48017611\_101.PNL# 2

- [1] APU (1) FUEL QTY meter. Indicates percent of fuel remaining in the APU fuel tank.
- [2] APU (2) FUEL QTY meter. Indicates percent of fuel remaining in the APU fuel tank.
- [3] APU (3) FUEL QTY meter. Indicates percent of fuel remaining in the APU fuel tank.
- [4] APU (1) FUEL PRESS meter. Displays tank inlet fuel pressure in psia.
- [5] APU (2) FUEL PRESS meter. Displays tank inlet fuel pressure in psia.
- [6] APU (3) FUEL PRESS meter. Displays tank inlet fuel pressure in psia.
- [7] APU (1) H2O QTY meter. Indicates percent of water remaining in the WSB water tank.
- [8] APU (2) H2O QTY meter. Indicates percent of water remaining in the WSB water tank.
- [9] APU (3) H2O QTY meter. Indicates percent of water remaining in the WSB water tank.
- [10] APU (3) OIL TEMP meter. Displays inlet lubricating oil temp into gearbox in degrees Fahrenheit.
- [11] APU (2) OIL TEMP meter. Displays inlet lubricating oil temp into gearbox in degrees Fahrenheit.
- [12] APU (1) OIL TEMP meter. Displays inlet lubricating oil temp into gearbox in degrees Fahrenheit.
- [13] HYD (1) QTY meter. Display hydraulic fluid quantity in reservoir.
- [14] HYD (2) QTY meter. Display hydraulic fluid quantity in reservoir.
- [15] HYD (3) QTY meter. Display hydraulic fluid quantity in reservoir.

**[16]** HYD (1) PRESS meter. Displays hydraulic pressure measurement.

**[17]** HYD (2) PRESS meter. Displays hydraulic pressure measurement.

**[18]** HYD (3) PRESS meter. Displays hydraulic pressure measurement.

NO.	DISPLAY PARAMETER	UNITS	METER DISPLAYED RANGE	TICK LOCATION	STATUS COLORS	
					Red	Green
1,2,3	APU (1,2,3) FUEL QTY meter	%	0-100	20	0-19	20+
4,5,6	APU (1,2,3) FUEL PRESS meter	psia	0-500			always
7,8,9	APU (1,2,3) H2O QTY meter	%	0-100	40	0-39	40+
10,11,12	APU (1,2,3) OIL TEMP meter	degF	0-500	45, 290	0-44 or 291+	45-290
13,14,15	HYD (1,2,3) QTY meter	%	0-100	40, 95	0-39 or 96+	40-95
16,17,18	HYD (1,2,3) PRESS meter	psia	0-4000	500, 1000, 2400	0-500 or 1001-2399	501-1000 or 2400+

# SPI DISPLAY

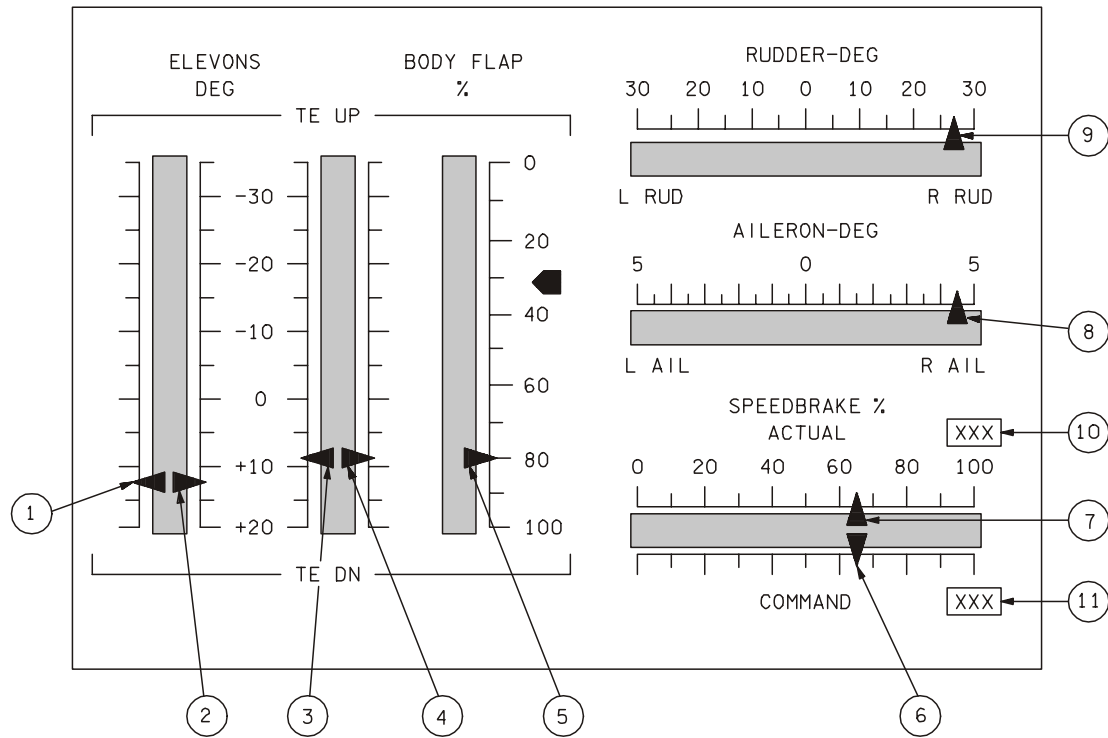

48017610\_101.PNL: 3

NO.	DISPLAY PARAMETER	UNITS	METER DISPLAY RANGE
1	LEFT OUTBOARD ELEVON POSITION	degrees	-35 to 20
2	LEFT INBOARD ELEVON POSITION	degrees	-35 to 20
3	RIGHT INBOARD ELEVON POSITION	degrees	-35 to 20
4	RIGHT OUTBOARD ELEVON POSITION	degrees	-35 to 20
5	BODY FLAP POSITION	%	0-100
6	SPEEDBRAKE COMMANDED POSITION	%	0-100
7	SPEEDBRAKE ACTUAL POSITION	%	0-100
8	AILERON POSITION	degrees	-5 to 5
9	RUDDER POSITION	degrees	-30 to 30
10	NUMERIC SPEEDBRAKE ACTUAL POSITION	%	0-100
11	NUMERIC SPEEDBRAKE COMMANDED POSITION	%	0-100

A/E PRIMARY FLIGHT DISPLAY (A/E PFD)

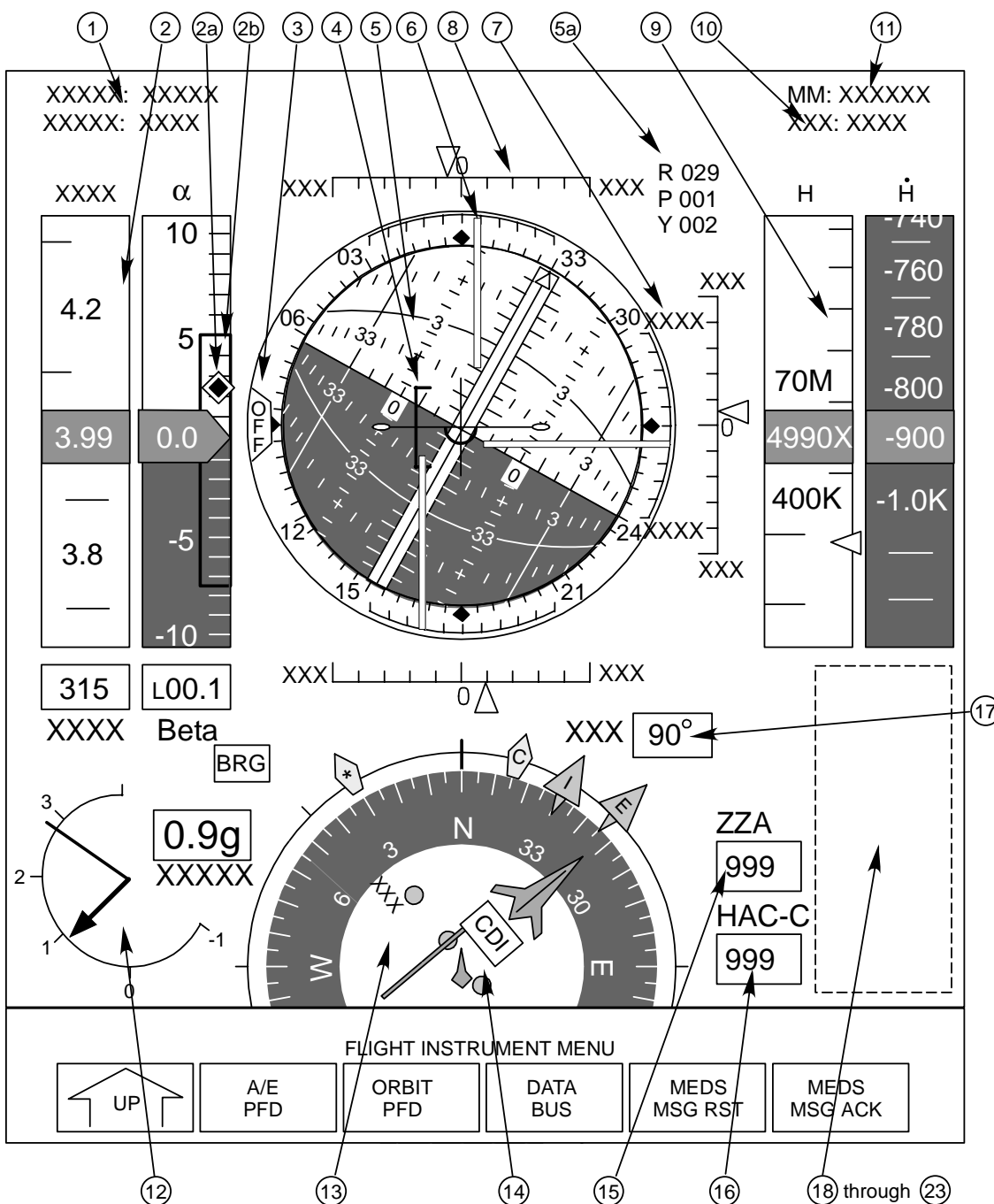

**[1]** FCS Configuration – DAP and throttle mode. During powered flight (MM 101-103 & MM 601), the fields show DAP mode (AUTO or CSS) and Throttle mode (AUTO or MAN). If CSS or MAN are selected, a yellow box is drawn around the fields. Post-MECO (MM 104-106), the DAP mode will indicate AUTO or INRTL, while the throttle field is blanked in MM 103 at MECO confirmed and throughout MM 104-106. In MM 301-303, the upper field will show DAP: AUTO or INRTL as in post-MECO OPS 1, while the lower field remains blank. During Entry (MM 304, 305, 602, & 603), the fields display the Pitch and Roll/Yaw DAP mode (AUTO or CSS) in the upper and lower fields, respectively. Additionally, a yellow box is drawn around the field if CSS is selected prior to M = 1. For PASS, the following table summarizes this field as well as items 10 and 11.

Indicator		Major mode												
		102	103*	104	105	106	301	302	303	304	305	601	602	603
DAP	ASC DAP AUTO/CSS	X	X									X		
	TRANS DAP AUTO/INRTL			X	X	X	X	X	X					
	AEROJET DAP P AUTO/CSS									X	X		X	X
	AEROJET DAP R/Y AUTO/CSS									X	X		X	X
SBTC	ASC DAP Throttle AUTO/MAN	X	X									X		
	AEROJET DAP SB AUTO/MAN									X	X		X	X
ADI Attitude Switch Position		X	X	X	X	X	X	X	X			X		
Major Mode		X	X	X	X	X	X	X	X	X	X	X	X	X
Abort Modes		X	X	X	X	X	X	X	X	X	X	X	X	X

\* Due to a software programming limitation, if the DAP is moded to INRTL in MM 103 post MECO, DAP will indicate CSS when, in fact, it should indicate INRTL.

- [2]** Alpha/Mach Indicator (AMI) – Provides NAV derived and barometric angle of attack ( $\alpha$ ) in degrees, and velocity in Knots Equivalent Airspeed (KEAS) or Mach number. The source of the data is determined by the AIR DATA switch (Left, Right, or NAV). Both tapes scroll up and down within their respective windows, with the tape digital value provided in a white-on-black background format in a box at the tape’s center. The tape displays the Mach value, and the digital readout below the tape shows KEAS, for all major modes except MM 305 and 603. For MM 305 and 603, the digital readout and tape values will swap at  $M < 0.9$ . The digital readout label will also change from “KEAS” to “M”. Likewise, the label above the velocity tape changes with major mode and RTLS flyback status. In MM 101, 102, 304, 305, 602, and 603, the label will be “M/VR” indicating relative velocity is displayed. In MM 103 and 104, “M/VI” is displayed indicating inertial velocity. During Powered RTLS (MM 601), prior to PPA, the label will be “M/VI” indicating inertial velocity, and after PPA “M/VR” indicating relative velocity.

Invalid data is indicated when a tape is replaced by a blank red box.

In MM 102/103 and 601, a beta value (in degrees) is provided below the alpha tape. “L” and “R” indicate the yaw steering required to null the beta value, and used in conjunction with the “E” bearing pointer. Note: Due to a coding limitation, there is a brief window during RTLS flyback (between  $V_{REL} = 0$  and  $\alpha = 90$  degrees) when the beta sense will not be consistent with the “E” bearing pointer, and the two indicators will appear to be in conflict. This is due to vehicle attitude and relative motion, but will be corrected once vehicle acceleration is high enough to cause alpha to decrease from 90 degrees. Both the “E” pointer and Beta digital blank at altitude  $> 200K$  or MET  $> 2:30$ , whichever occurs first. Resolution of the digital is one decimal place.

Alpha is shown in a scrolling window with a fixed pointer indicating the current angle of attack in one degree increments. The digital decimal value is provided as part of the pointer using white numbers on a black background. Positive alpha values are black numbers on a white background, and negative values are white numbers on a black background. A Max L/D diamond (2a in the illustration) indicates the optimum alpha value for maximum lift over drag flying techniques. The L/D diamond is displayed when Mach  $< 3.0$ .

A green maximum and minimum alpha bar (2b in the illustration) is provided in both PASS and BFS MM 304, 305, 602, and 603, with the exception of contingency aborts. Note: When using low alpha techniques during aborts, the alpha bar may not be visible.

Ranges:

Alpha +/- 180 degrees

Mach/Velocity - Mach 0-4, 4K - 27K fps, 0 - 500 KEAS

- [3]** ADI OFF Flag – Used to indicate whether valid GPC data is driving the ADI software. A remnant of the mechanical dedicated displays, presence of the OFF flag can still be used to determine if a flight critical bus problem exists at the GPC driving the IDP hosting the ADI, and is used in DPS malfunction procedures. For invalid or missing data in any or all axes during ascent or entry phase (due to commfaults or GPC to IDP communication errors), the ADI will continue to be displayed but the OFF flag will be present, the needles will be stowed (blanked), and the ball will be static.
- [4]** ADI Theta Limit Bracket – A green limit bracket available while  $M < 2$  if either 1) air data is inhibited to G&C, 2) no ADTA/probes are available, or 3) an air data dilemma exists (AD DG flag set to 0). The upper and lower bracket represent the theta high and low limits, respectively, as determined by guidance. The bracket is dynamic and varies with bank angle. The limits are the same as the theta limit indicators available on the VERT SIT display.
- [5]** Attitude Determination Indicator (ADI) – Simulated enclosed ball and digital readouts. The ball provides three degrees of freedom, allowing it to be positioned in response to software-generated commands corresponding to the Orbiter roll, pitch, and yaw attitude. The numbers on the ball and around the case are angle magnitudes, with the trailing zero deleted for simplicity. The digital readout (5a in the illustration) is expressed in Orbiter Roll, Pitch, and Yaw corresponding to the ADI ATTITUDE switch setting (INRTL, LVLH, or REF). A vehicle symbol is provided fixed to the center of the ADI window as a reference.

PASS ADI sequencing is as follows:

Major Mode	101-103	104-106, 301-303	201& 202	304/602	305/603			
Phase	Ascent	Transition	Orbit	Entry	TAEM	A/L	Touchdown	
Attitude	INRTL	Inertial Reference Frame		Roll	Topodetic Roll			
	LVLH	LVIY*	LVLH	Pitch	Topodetic Pitch			
	REF	Stored Reference Frame		Yaw	Fixed at Zero			
Errors	Launch Guidance Command Errors		Total Attitude Errors		Roll	Roll Total Attitude Error ( $\Phi - \Phi_{CMD}$ )		
					Pitch	Angle of Attack ( $\alpha$ ) Error	Normal Acceleration Error ( $N_z$ )	Slapdown Pitch Rate Error
					Yaw	Estimated Sideslip ( $\beta$ )		

Rates	Selected RGA Roll, Pitch, & Yaw Rates (Body Axis)	IMU Derived Body Rates	Roll	Stability Roll Axis Rate
			Pitch	Selected RGA Pitch Rate
			Yaw	Stability Yaw Axis Rate

\* LVIY is a specialized convention similar to LVLH. LVIY fixes yaw at zero, is referenced to MECO targets, and uses a YAW, PITCH, ROLL rotational sequence. In contrast, LVLH is based on the current (instantaneous) position and uses a PITCH, YAW, ROLL rotation sequence.

BFS ADI sequencing is as follows:

Major Mode	101-103		104-106, 301-303	201& 202	304/602		305/603		
Phase	Ascent		Transition	Orbit	Entry		TAEM	A/L	Touchdown
Attitude	INRTL	Inertial Reference Frame			Roll	Topodetic Roll			
	LVLH	LVIY	LVLH		Pitch	Topodetic Pitch			
	REF	Stored Reference Frame			Yaw	Fixed at Zero			
Errors	Launch Guidance Command Errors		Total Attitude Errors		Roll	Roll Total Attitude Error ( $\Phi - \Phi_{CMD}$ )			
					Pitch	Angle of Attack ( $\alpha$ ) Error	Normal Acceleration Error ( $N_z$ )	Slapdown Pitch Rate Error	
					Yaw	Estimated Sideslip ( $\beta$ )			
Rates	Selected RGA Roll, Pitch, & Yaw Rates (Body Axis)			IMU Derived Body Rates	Roll	Stability Roll Axis Rate			
					Pitch	Selected RGA Pitch Rate			
					Yaw	Stability Yaw Axis Rate			

- [6]** ADI Attitude Error Needles – The ADI has three needles which provide a continuous indication of vehicle attitude errors in degrees. These needles extend in front of the ADI ball from the top (roll), right (pitch), and bottom (yaw). Each needle has a background scale with graduation marks to allow the crew to deduce the magnitude of the attitude error. The scaling and definition of these errors varies with the parameter, the mission phase, and the error switch setting.

The attitude error needles are fly-to indicators. During powered flight (either ascent or OMS/RCS burns), the errors are guidance thrust vector errors. This means that during engine burns, the errors reflect TVC trim errors, and during RCS burns the errors reflect the guidance VGO error. Note that if bad IMU velocity data is processed, the error needles will be incorrect.

- [7]** Pitch Scale Labels – Reflects the setting of the ADI ERROR switch and displayed in degrees. During TAEM (MM 305 and 603) and  $N_z$  hold (MM 602), the Pitch Attitude Error scale is in g's, and indicated by a "g" next to the scale value.

- [8]** ADI Rate Needles – Provide a continuous indication of vehicle body rates in all supported major modes, except in MM 305 or 603 with the ADI RATE Switch in the Medium (MED) position, when the ADI Rate pointers display the Time to Heading Alignment Cone (HAC) Intercept, Altitude Error, and Crosstrack Error. Roll, pitch, and yaw rates are indicated by the top, right, and bottom pointers, respectively, when the ADI displays vehicle body rates. Time to HAC Intercept, Altitude Error, and Crosstrack Error are indicated by the top, right, and bottom pointers, respectively,



when in MM 305/603 and the ADI RATE Switch is in the Medium (MED) position. Graduation marks on either side of the null (center) mark determine the rate magnitude based on full scale range, which varies with the rate switch setting.

Rate scale labels correspond to the setting of the ADI rate switch.

GNC Major Mode	Switch Position	Attitude Rate Full Scale			Attitude Error Full Scale		
		Roll	Pitch	Yaw	Roll	Pitch	Yaw
Ascent (101-106, 601) On-Orbit (201, 202, 801) Transition (301-303)	High	Deg/s 10	Deg/s 10	Deg/s 10	Deg/s 10	Deg/s 10	Deg/s 10
	Med	5	5	5	5	5	5
	Low	1	1	1	1	1	1
Entry (304, 602*) * $\alpha$ Transition and $\alpha$ Recovery	High	Deg/s 10	Deg/s 10	Deg/s 10	Deg 25	Deg 5	Jets 2.5
	Med	5	5	5	25	2	2.5
	Low	1	1	1	10	1	2.5
MM 602* *N <sub>Z</sub> Hold	High	Deg/s 10	Deg/s 10	Deg/s 10	Deg 25	Gs 1.25*	Jets 2.5
	Med	5	5	5	25	1.25*	2.5
	Low	1	1	1	10	0.5	2.5
TAEM (MM 305, 603) WOWLON = 0	High	Deg/s 5	Deg/s 5	Deg/s 5	Deg 25	Gs 1.25*	Jets 2.5
	Med	5	5	5	25	1.25*	2.5
	Low	5	5	5	10	0.5	2.5
HAC Phases (MM 305, 603)	High Low	5 Deg/s 5 Deg/s	5 Deg/s 5 Deg/s	5 Deg/s 5 Deg/s			
S Turn & Acquisition	Med	Time to HAC (10 sec)	Altitude Err ( $\pm$ 5K ft)	Heading Err ( $\pm$ 5 Deg)			
Heading Alignment	Med	N/A - Blanked	Altitude Err ( $\pm$ 5K ft)	Radial Err ( $\pm$ 5 Deg)			
Prefinal	Med	N/A - Blanked	Altitude Err ( $\pm$ 1K ft)	T-Posn Err ( $\pm$ 2.5 K ft)			
Alt_Wheels $\geq$ H_Blank	Med	N/A - Blanked	Altitude Err ( $\pm$ 1K ft)	T-Posn Err ( $\pm$ 2.5 K ft)			
Alt_Wheels > H_Blank	Med	N/A - Blanked	N/A - Blanked	N/A - Blanked			
Alt_Wheels < H_Blank	Med	5 Deg/s	5 Deg/s	5 Deg/s			
WOWLON = 1 Rollout (MM 305, 603)	High	Deg/s 5	Deg/s 5	Deg/s 5	Deg 20	Deg 10	Deg 2.5
	Med	5	5	5	5	5	2.5
	Low	5	5	5	1	1	2.5

\* When full scale error is 1.25 Gs, label on error scale actually says 1.2 G due to space limitations and truncation.

Rate scales are labeled for all axes and are in deg/sec unless indicated by a suffix. For example, "5K" indicates the rate scale now serves purpose of being a lateral deviation indicator with max scale deflection of 5000 feet. Only the pitch error scale is labeled and is assumed to denote degrees of error except when a suffix is indicated; i.e., 1.2 G.

The yaw error needle has the same meaning throughout MM's 304 and 305: estimated sideslip ( $\beta$ ). For  $q\text{-bar} < 20$  psf, the sideslip angle is INRTL  $\beta$ ; i.e., the angle between the +X body axis and the Earth relative velocity. For  $q\text{-bar} \geq 20$  psf, estimated beta is based on  $N_Y$  and yaw jet effectiveness. Full scale on the display is equivalent to the yaw produced by the side force of 2.5 yaw jets.

- [9] Altitude/Vertical Velocity Indicator (AVVI) – Provides NAV-derived or barometric altitude in feet (ft), and NAV-derived and barometric altitude rate in feet/second (fps). During landing, the tape will display NAV altitude, but a radar altitude pointer will point to the radar altitude on the NAV tape, and the embedded digital will indicate valid radar altitude with an "R". Calibrated barometric data is selected in TAEM by positioning the AIR DATA switch to select the left or right probe. Starting at ground level (0 feet), the altitude tape numerical value increments every 50 feet, with 10 foot marks along the center of the tape up to 200 feet. From 200 to 1000 feet, the values increment every 200 feet, with marks every 100 feet. Beginning at 2000 feet altitude, the tape values transition to thousands of feet (indicated by a following "K" at 5000 feet), with numbers every 1000 feet, and marks every 500 feet up to 30K feet. From 30K to 100K, numbers

increment every 5K feet, with marks every 1K feet. Beginning at 100K, the marks are moved to the left side of the tape, and numbers incremented every 50K feet up to 400K. Above 400K feet altitude, the scale transitions to nautical miles (nmi), indicated by a following "M". Altitude numerical value is then incremented every 5 nmi beginning at 70 nmi, with marks along the right side of the tape every nautical mile up to 165 nm. Numbers and marks are black on a white background. During Entry and below 2000 feet, the tape background transitions from white to yellow. Invalid data is indicated when a tape is replaced by a blank red box.

Ranges:

Altitude - -1100 to 2000 ft. (blank), 30K - 400K ft (K), 66 - 165 nautical miles (M), 0 - 5000 ft (R)

Altitude Rate - -3000 to 3000 fps

- [10] FCS Configuration/ADI Attitude – The field below the major mode shows the applicable CDR or PLT ADI attitude selected, i.e. INRTL, LVLH, or REF (MM 101-106 and 601, and 301-303), or SB mode, i.e. AUTO or MAN (MM 304 and 305, and 602 and 603). A yellow box is drawn around the indicator if MAN SB is selected.
- [11] Major Mode – The current major mode is identified in the upper right hand corner of the display. If an abort has been declared, an indicator will verify the abort mode selected (R for RTLS, T for TAL, AOA for AOA, ATO for ATO, and CA for contingency aborts).
- [12] Vehicle Acceleration Meter – A vehicle acceleration meter (or G-meter) is provided in PASS MM 102, 103, 304, 305, 601, 602, & 603. The function of the meter is different in powered and glided flight, with the label changing to reflect the data being displayed. In powered flight, the meter reflects IMU-derived vehicle acceleration and is labeled "Accel". During glided flight, the meter displays the RM selected AA  $N_z$  value and is labeled " $N_z$ ". Both are represented by a digital value and a green needle. A magenta target  $N_z$  line is provided during MM 602 showing the target  $N_z$  value in glided flight.

Range:

-1 to 4 g

- [13] Horizontal Situation Indicator (HSI)

The compass card replaces N, E, S, and W with 0, 9, 18, and 27 in MM 102/103, and references the target insertion plane course as the baseline for 0 on the display. For MM 304/305 and MM 601-603, the card reflects magnetic heading indicated by N, E, S, and W being present on the compass card. In powered flight, the compass card is reverse drawn while inverted, thus will always reflect the correct heading information, regardless of whether the vehicle is heads-up or heads-down.

For ascent, heading references the target insertion plane, with 0 representing the pre-flight planned target insertion plane course. The course arrow is pinned at 0 unless TAL or ATO is selected with variable IY active. If TAL, the arrow is redefined to point at a tangent to a cross-range circle around the TAL site, and reflects the nominal or minimum crossrange, as appropriate. If ATO and variable IY is active, the course arrow indicates the new target inclination course (if redefined), with 0 still representing the pre-launch target insertion plane course. If variable IY steering is not active, the course arrow remains pegged at 0.

The  $V_{REL}$  Bearing Pointer, labeled "E", indicates the direction of the Earth-relative velocity vector relative to the vehicle nose (lubber line) & course (compass card/course arrow). It works in concert with the beta digital readout, and both the "E" bearing pointer and the beta digital blank on ascent at altitude > 200K or MET > 2:30.

In MM 102-104 and 601, the Inertial Bearing Pointer, labeled "I", indicates the direction of the inertial velocity vector relative to nose & course. It is not displayed in glided or orbital flight.

The Runway/HAC Bearing Pointer (labeled "\*" in the figure) indicates "R" for bearing to runway in powered flight and "H" for bearing to HAC in gliding flight. It appears at RTLS/TAL abort select & entry (MM 304/305 and 602/603).

The HAC Center Bearing Pointer, labeled "C", indicates bearing to the HAC center during TAEM (MM 305 and 603).

The bearing flag (BRG) is displayed when valid TACAN, GPS, or MLS data is not available due to commfault, lack of comm-lock, or invalid station.

Ranges:

Compass Card - 0- 360 degrees

- [14]** Course Deviation Indicator (CDI) - Shows the lateral off-set from the targeted plane or course in nautical miles. It is auto re-scaled at 50,10, & 1 nm and labeled accordingly, with one mile scaling only occurring after 6+30 MET. The CDI bar & scale dots are available during nominal powered flight (MM 102-104), and in TAEM and A/L (MM 305 and 603). They are blanked in TAL powered flight (MM 103), but displayed in MM 104 with the CDI flag present (indicating it is static). The CDI is blanked during powered RTLS (MM 601). During entry (MM 304 and 602), the CDI dots are displayed but without scaling (indicated by the absence of labels). During TAEM (MM 305 and 603), the CDI represents the angular displacement from the runway centerline, and the scale and digital set to 10 (deg). At HSI approach and land, the scale and digital changes to 2.5 (deg).

Range :

1, 10, and 50 nautical miles

Approach/Land - 1 dot = 1.25 deg

TAEM - 1 dot = 5 deg

- [15]** Range to Landing Site - The range to the SPEC 50 primary runway is displayed in nautical miles. The range label (above the range value) reflects the SPEC 50 primary runway. Range to the landing site is displayed in powered flight at TAL MM 103, RTLS MM 601, and after ECAL/BDA abort selection. In glided flight, the range to the runway is displayed at MM 304 and 602, and both range to the runway and HAC center are displayed at MM 305 and 603.

Range:

0 - 999.9 nautical miles

- [16]** Range to HAC center - Available during TAEM (MM 305 and 603), and corresponds to HAC center bearing pointer.

- [17]**  $\Delta$ AZ or HAC Turn Angle - As  $\Delta$ AZ this field displays the angle between the vehicle flight path and the HAC tangent in degrees. The outline box will flash red when roll reversal limits are met or exceeded (10.5° or 17°). During TAEM post-HAC intercept, the field changes to HAC Turn Angle (HTA).

Ranges:

$\Delta$ AZ - 0 - 180 degrees

HTA - 0 -360 degrees

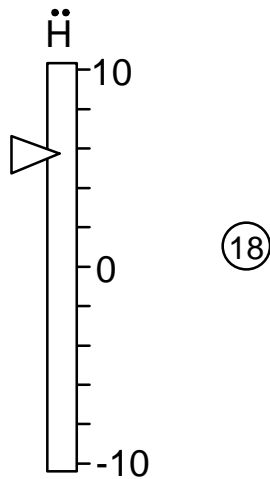

**[18]** Altitude Acceleration – Available in PASS MM 304 and 602. A pointer slides vertically on a scale in  $\text{fps}^2$ . Maximum range of the scale is  $\pm 10 \text{fps}^2$ . A green pointer indicates the current NAV-derived altitude acceleration value.

Range:

Altitude Acceleration –  $-10$  to  $10 \text{fps}^2$

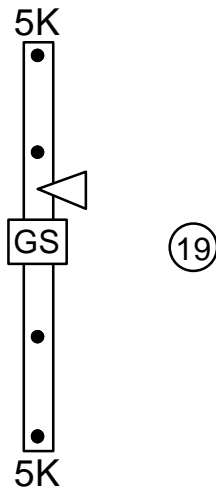

**[19]** Glide Slope Indicator (GSI) – Distance of the vehicle above or below the desired glide slope and is indicated by the deflection of the pointer. The pointer is a fly-to indicator, so an increase in glide slope deviation above (below) the desired slope results in deflection of the pointer downward (upward). The GSI computation is available above 1500 ft in TAEM MM 305 and 603. The pointer is blanked prior to MM 305 or 603, and the GS flag is displayed below 1500 ft.

Range:

TAEM –  $-5000$  to  $5000$  ft, 1 dot =  $2500$  ft

Approach/Land –  $-1000$  to  $1000$  ft, 1 dot =  $500$  ft

$\Delta$ X-Trk	0.0	⑳
X-Trk	0.0	㉑
$\Delta$ Inc	0.00	㉒
Tgt Inc	0.00	㉓

**[20]** Delta Cross Track digital –  $\Delta$  X-Trk is X-Trk minus the radius of the targeted TAL cross-range circle in nautical miles, showing the lateral distance the vehicle must steer to meet TAL cross-range targeting. It is only available for TAL abort, and shows zero if the current ground track/plane is inside the TAL cross-range target. It supplements the course arrow, “I” bearing pointer, & “R” bearing pointer.

**[21]** Cross Track digital – X-Trk is the lateral off-set distance from targeted plane in nautical miles, and supplements the course deviation indicator (CDI). The value is positive for positions north of the target insertion plane, and negative for positions south of the target plane. X-Trk is available for nominal uphill, TAL, and ATO powered flight (MM 102 and 103).

In MM103 TAL, X-Trk represents the lateral offset the current inertial velocity vector is making with the TAL runway. If the inertial velocity vector is currently pointing north of the runway, the value is positive. If pointing south of the runway-bearing pointer, the value is negative.

**[22]** Delta Inclination digital –  $\Delta$  Inc is the difference between the current & targeted inclination, in degrees.  $\Delta$  Inc is available for nominal uphill, TAL, ATO, and AOA powered flight (MM 102 and 103).

**[23]** Target Inclination digital – Tgt Inc indicates the value of the targeted inclination in degrees. It is only available for ATO (MM 103), and serves to indicate to the crew whether the IY plane was redefined at ATO declaration.

The dedicated displays featured in PASS are available in the following major modes:

		OPS 9		OPS 1						OPS 2		OPS 8		OPS 3					OPS 6		
		MM 901	MM 101	MM 102	MM 103	MM 104	MM 105	MM 106	MM 201	MM 202	MM 801	MM 301	MM 302	MM 303	MM 304	MM 305	MM 601	MM 602	MM 603		
ADI	BALL	X	X	X	X	X	X	X	X	X	X	X	X	X	X	X	X	X	X		
	ERROR NEEDLES & SCALE	X [5]	X	X	X	X	X	X	X	X	X	X	X	X	X	X	X	X	X		
	RATE NEEDLES & SCALE	X [5]	X	X	X	X	X	X	X	X	X	X	X	X	X	X	X	X	X		
	DIGITAL R, P, Y	X	X	X	X	X	X	X	X	X	X	X	X	X	X	X	X	X	X		
	THETA LIMIT BRACKET	-	-	-	-	-	-	-	-	-	-	-	-	-	-	X	-	-	X		
	OFF FLAG	X	X	X	X	X	X	X	X	X	X	X	X	X	X	X	X	X	X		
	ADI ATT SW	-	X	X	X	X	X	X	-	-	-	X	X	X	-	-	X	-	-		
HSI	COMPASS CARD	X	X	X	X	X	-	-	-	-	-	-	-	X	X	X	X	X			
	COURSE ARROW	X	X	X	X	X	-	-	-	-	-	-	-	X	X	-	X	X			
	CDI	X	X	X	X [2]	X [2]	-	-	-	-	-	-	-	X	X	-	X	X			
	CDI FLAG	X	X	X	X [2]	X [2]	-	-	-	-	-	-	-	X	X	-	X	X			
	GSI	X	-	-	-	-	-	-	-	-	-	-	-	-	X	-	-	X			
	GSI FLAG	X	-	-	-	-	-	-	-	-	-	-	-	-	X	-	-	X			
	HAC POINTER (PRI BRG)	X [7]	-	-	X [1]	X [1]	-	-	-	-	-	-	-	X	X	X [4]	X	X			
	HAC CENTER POINTER	-	-	-	-	-	-	-	-	-	-	-	-	-	X	-	-	X			
	RUNWAY POINTER (SEC BRG)	X [6]	-	-	-	-	-	-	-	-	-	-	-	X	X	X [3]	X	X			
	VREL POINTER	-	-	X	X	-	-	-	-	-	-	-	-	-	-	-	X	-	-		
	VI POINTER	-	X	X	X	X	-	-	-	-	-	-	-	-	-	-	-	-	-		
	PRI R/W RANGE	X [8]	-	-	X [1]	-	-	-	-	-	-	-	-	X	X	X	X	X	X		
	BRG FLAG	X	-	-	X [1]	-	-	-	-	-	-	-	-	X	X	X	X	X	X		
	Δ AZ	-	-	-	X [1]	-	-	-	-	-	-	-	-	X	X	X	X	X	X		
	Δ X-TRK	-	-	-	X [1]	-	-	-	-	-	-	-	-	-	-	-	-	-	-		
	Δ INC	-	-	X	X	X	-	-	-	-	-	-	-	-	-	-	-	-	-		
TGT INC	-	-	X [9]	X [9]	-	-	-	-	-	-	-	-	-	-	-	-	-	-			
X-TRK	-	-	X	X	X	-	-	-	-	-	-	-	-	-	-	-	-	-			
AMI	V <sub>I</sub>	X [8]	-	-	X	-	-	-	-	-	-	-	-	-	-	X [3]	-	-			
	V <sub>REL</sub>	X [8]	-	X	-	-	-	-	-	-	-	-	-	X	X	X [4]	X	X			
	VEL DIGITAL	X [8]	-	X	X	-	-	-	-	-	-	-	-	X	X	X	X	X			
	α	X [8]	-	X	X	-	-	-	-	-	-	-	-	X	X	X	X	X			
	β	-	-	X	X	-	-	-	-	-	-	-	-	-	-	X	-	-			
	MAX L/D DIAMOND	-	-	-	-	-	-	-	-	-	-	-	-	X	X	-	X	X			
	MAX/MIN α	-	-	-	-	-	-	-	-	-	-	-	-	X	X	-	X [10]	X [10]			
AVVI	H	X [8]	-	X	X	X	-	-	-	-	-	-	-	X	X	X	X	X			
	H DOT	X [8]	-	X	X	X	-	-	-	-	-	-	-	X	X	X	X	X			
	H ACCEL	X [8]	-	-	-	-	-	-	-	-	-	-	-	X	-	-	X	-			

		OPS 9	OPS 1						OPS 2		OPS 8	OPS 3					OPS 6		
		MM 901	MM 101	MM 102	MM 103	MM 104	MM 105	MM 106	MM 201	MM 202	MM 801	MM 301	MM 302	MM 303	MM 304	MM 305	MM 601	MM 602	MM 603
G-METER	N <sub>2</sub>	X [8]	-	X	X	-	-	-	-	-	-	-	-	X	X	X	X	X	
	N <sub>2</sub> DIGITAL	X [8]	-	X	X	-	-	-	-	-	-	-	-	X	X	X	X	X	
	TARGET N <sub>2</sub>	-	-	X	X	-	-	-	-	-	-	-	-	X	X	X	X	X	
MAJOR MODE	MAJOR MODE	-	X	X	X	X	X	X	-	-	-	X	X	X	X	X	X	X	
	ABORT INDICATOR	-	-	X	X	X	-	-	-	-	-	-	-	X	X	X	X	X	
FCS CONFIG	DAP AUTO/CSS	-	X	X	X	-	-	-	-	-	-	-	-	-	-	X	-	-	
	DAP AUTO/INRTL	-	-	-	-	X	X	X	-	-	-	X	X	X	-	-	-	-	
	DAP P AUTO/CSS	-	-	-	-	-	-	-	-	-	-	-	-	X	X	-	X	X	
	DAP R/Y AUTO/CSS	-	-	-	-	-	-	-	-	-	-	-	-	X	X	-	X	X	
	THRITTLE AUTO/MAN	-	X	X	X [11]	-	-	-	-	-	-	-	-	-	-	X	-	-	
	SB AUTO/MAN	-	-	-	-	-	-	-	-	-	-	-	-	X	X	-	X	X	

- [1] TAL only
- [2] Blanked for TAL
- [3] RTLS Pre PPA
- [4] RTLS Post PPA
- [5] No Scale
- [6] As secondary bearing pointer
- [7] As primary bearing pointer
- [8] Invalid (red box)
- [9] ATO only
- [10] Except contingency abort
- [11] Blanks at MECO confirmed

The dedicated displays featured in BFS are available in the following major modes:

		OPS 1					OPS 3					OPS 6		
		MM 102	MM 103	MM 104	MM 105	MM 106	MM 301	MM 302	MM 303	MM 304	MM 305	MM 601	MM 602	MM 603
ADI	BALL	X	X	X	X	X	X	X	X	X	X	X	X	X
	ERROR NEEDLES & SCALE	X	X	X	X	X	X	X	X	X	X	X	X	X
	RATE NEEDLES & SCALE	X	X	X	X	X	X	X	X	X	X	X	X	X
	DIGITAL R, P, Y	X	X	X	X	X	X	X	X	X	X	X	X	X
	THETA LIMIT BRACKET	-	-	-	-	-	-	-	-	-	-	-	-	-
	OFF FLAG	X	X	X	X	X	X	X	X	X	X	X	X	X
	ADI ATT SW	X	X	X	X	X	X	X	X	-	-	X	-	-
HSI	COMPASS CARD	X	X	X	-	-	-	-	X	X	X	X	X	X
	COURSE ARROW	X	X	X	-	-	-	-	X	X	-	X	X	X
	CDI	X	X [2]	X [2]	-	-	-	-	X	X	-	X	X	X
	CDI FLAG	X	X [2]	X [2]	-	-	-	-	X	X	-	X	X	X
	GSI	-	-	-	-	-	-	-	-	X	-	-	X	X
	GSI FLAG	-	-	-	-	-	-	-	-	X	-	-	X	X
	HAC POINTER (H) (PRI BRG)	-	X [1]	X [1]	-	-	-	-	X	X	X [4]	X	X	X
	HAC CENTER (C) POINTER	-	-	-	-	-	-	-	-	X	-	-	-	X
	RUNWAY POINTER (R) (SEC BRG)	-	-	-	-	-	-	-	X	X	X [3]	X	X	X
	VREL POINTER (E)	X	X	-	-	-	-	-	-	-	X	-	-	-
	VI POINTER (I)	X	X	X	-	-	-	-	-	-	-	-	-	-
	PRI R/W RANGE	-	-	-	-	-	-	-	X	X	X	X	X	X
	BRG FLAG	-	-	-	-	-	-	-	X	X	X	X	X	X
	$\Delta$ AZ	-	-	-	-	-	-	-	X	X	X	X	X	X
	$\Delta$ X-TRK	-	-	-	-	-	-	-	-	-	-	-	-	-
	$\Delta$ INC	X	X	X	-	-	-	-	-	-	-	-	-	-
	TGT INC	X [9]	X [9]	X	-	-	-	-	-	-	-	-	-	-
X-TRK	X	X	X	-	-	-	-	-	-	-	-	-	-	
AMI	$V_i$	-	-	-	-	-	-	-	-	-	-	-	-	
	$V_{REL}$	-	-	-	-	-	-	-	X	X	-	X	X	
	VEL DIGITAL	-	-	-	-	-	-	-	X	X	X	X	X	
	$\alpha$	-	-	-	-	-	-	-	X	X	X	X	X	
	$\beta$	X	X	-	-	-	-	-	-	-	X	-	-	
	MAX L/D DIAMOND	-	-	-	-	-	-	-	X	X	-	X	X	
	MAX/MIN $\alpha$	-	-	-	-	-	-	-	X	X	-	X	X	
AVVI	H	-	-	-	-	-	-	-	X	X	X	X	X	
	H DOT	-	-	-	-	-	-	-	X	X	X	X	X	
	H ACCEL	-	-	-	-	-	-	-	X	-	-	X	-	



		OPS 1					OPS 3					OPS 6		
		MM 102	MM 103	MM 104	MM 105	MM 106	MM 301	MM 302	MM 303	MM 304	MM 305	MM 601	MM 602	MM 603
G-METER	N <sub>2</sub>	-	-	-	-	-	-	-	-	X	X	-	X	X
	N <sub>2</sub> DIGITAL	-	-	-	-	-	-	-	-	X	X	-	X	X
	TARGET N <sub>2</sub>	-	-	-	-	-	-	-	-	X	X	-	X	X
MAJOR MODE	MAJOR MODE	X	X	X	X	X	X	X	X	X	X	X	X	X
	ABORT INDICATOR	X	X	X	-	-	-	-	X	X	X	X	X	X
FCS CONFIG	DAP AUTO/CSS	X	X	-	-	-	-	-	-	-	-	X	-	-
	DAP AUTO/INRTL	-	-	X	X	X	X	X	-	-	-	-	-	-
	DAP P AUTO/CSS	-	-	-	-	-	-	-	X	X	-	X	X	X
	DAP R/Y AUTO/CSS	-	-	-	-	-	-	-	X	X	-	X	X	X
	THROTTLE AUTO/MAN	-	-	-	-	-	-	-	-	-	-	X	-	-
	SB AUTO/MAN	-	-	-	-	-	-	-	-	X	X	-	X	X

- [1]** TAL only
- [2]** Blanked for TAL
- [6]** As secondary bearing pointer
- [7]** As primary bearing pointer
- [9]** ATO only

PRELAUNCH A/E PFD

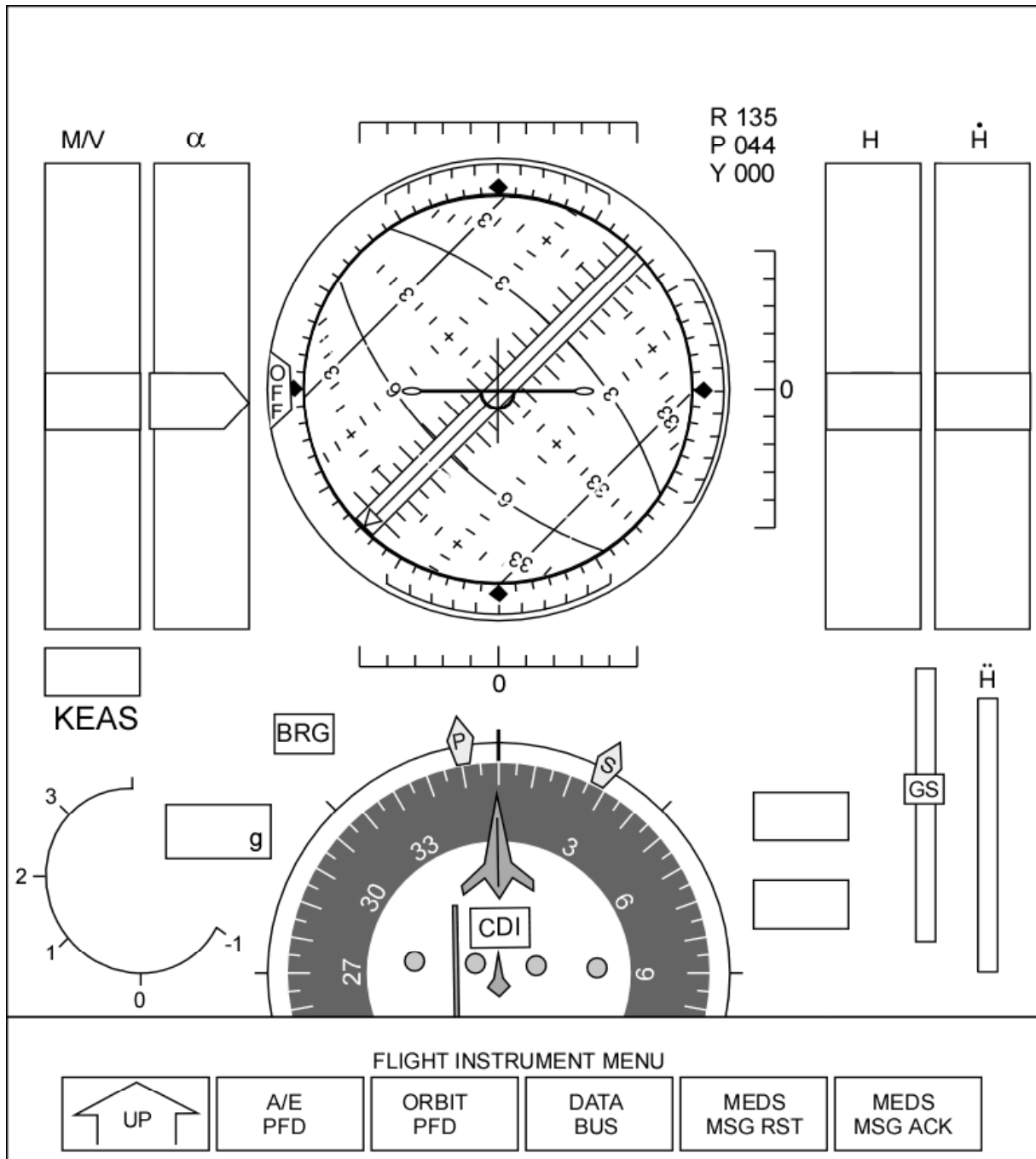

OPS 9

The OPS 9 A/E PFD contains no active elements, however outlines for all major display elements are provided.

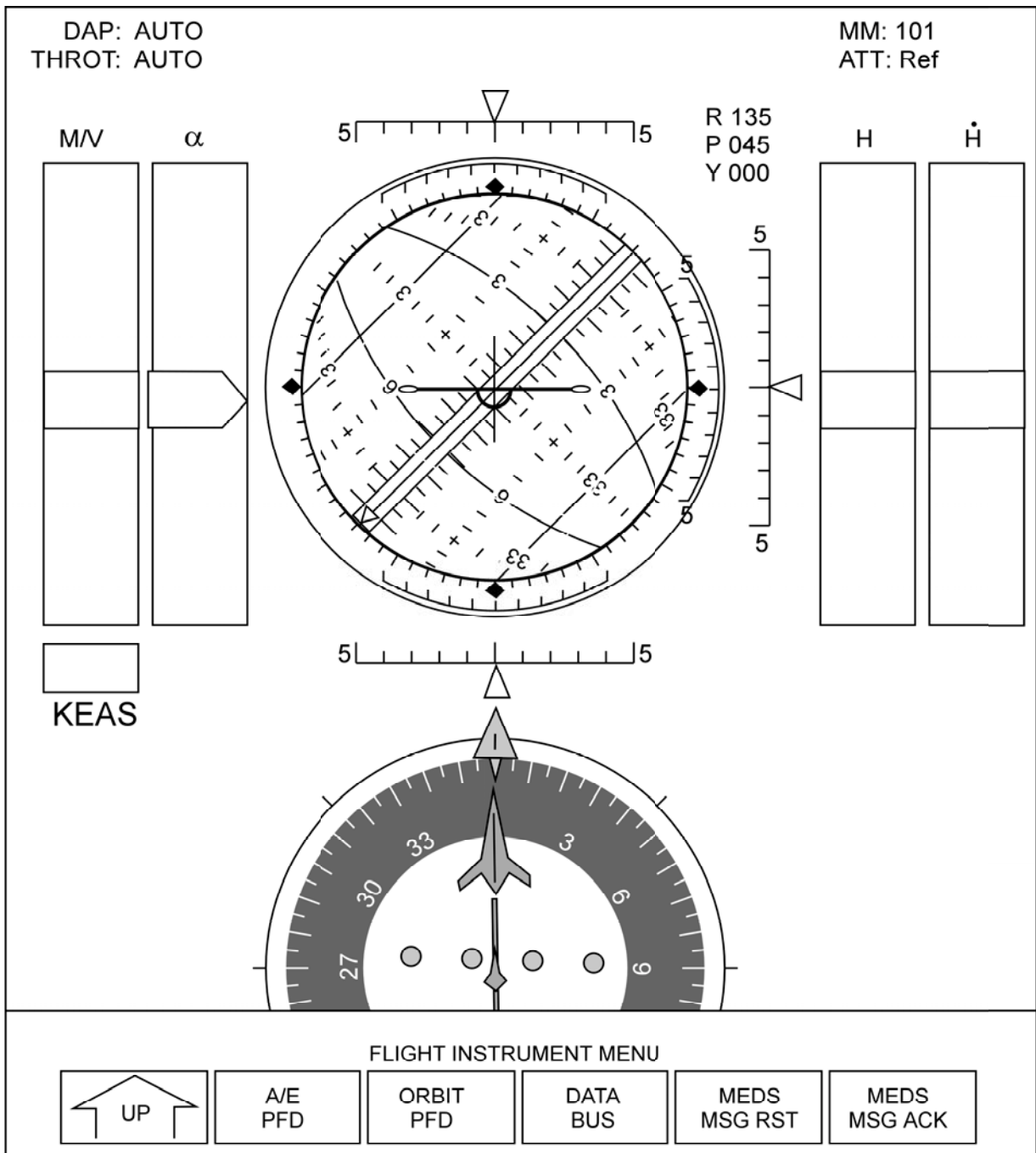

MM 101

In MM 101 (Prelaunch OPS 1), the ADI attitude ball will become active at NAV initialization (about T-4 minutes). The ADI ATT will reflect the setting of the ADI ATTITUDE switch.

## ORBIT PRIMARY FLIGHT DISPLAY (ORB PFD)

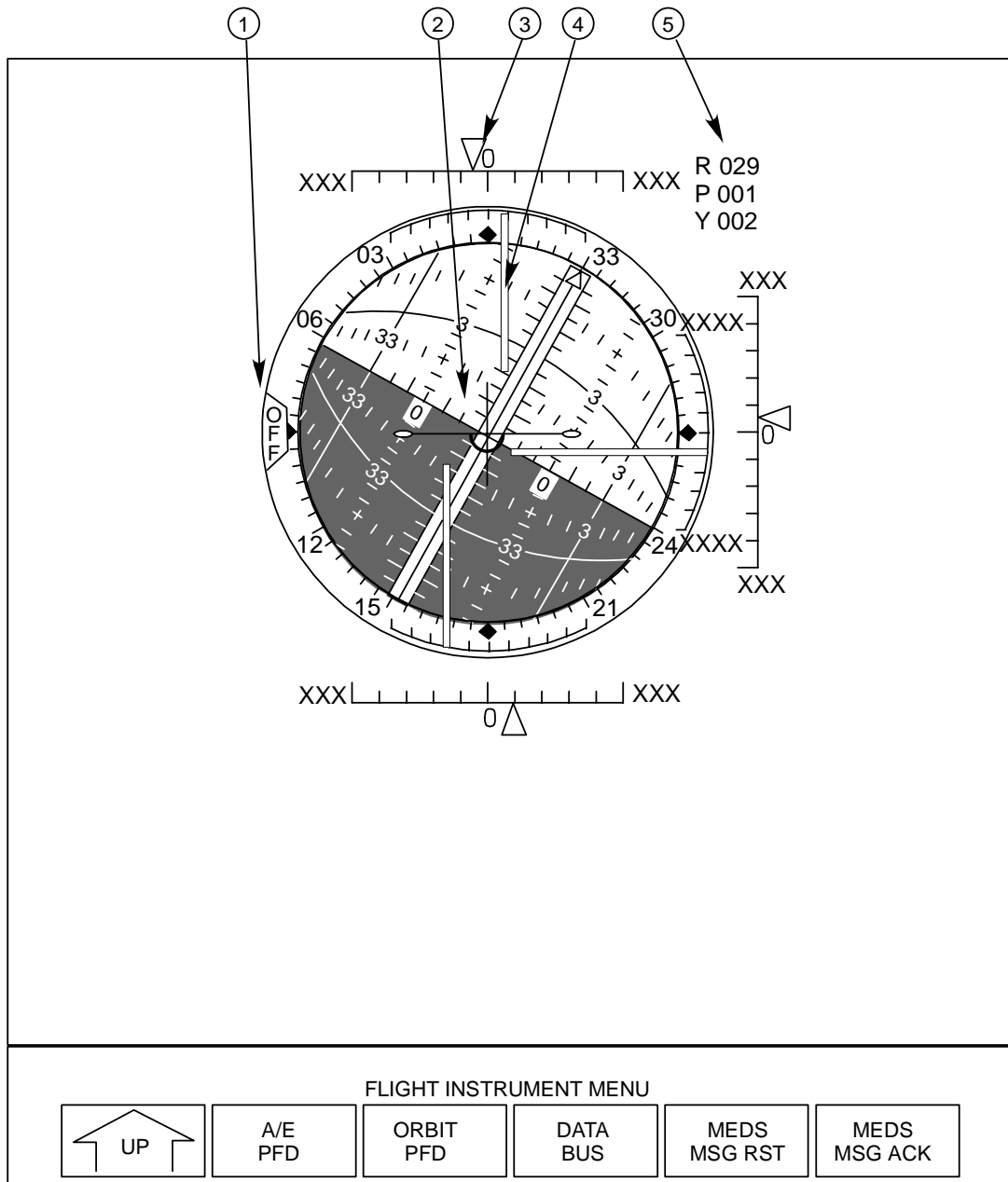

- [1] Off Flag – Indicates no updates from GPC. The ADI will freeze in all axes if IMU data are missing (CF or DG bad), and needles will be stowed (blanked), and ball static.
- [2] Attitude ball – IMU based attitude. Reflects attitude defined by ADI ATTITUDE switch.
- [3] Rate Needles – IMU derived body rates in degrees/second. Reflects scale selected by ADI Rate switch (see A/E PFD). Scale label is located at the ends of each scale.
- [4] Error Needles – Total attitude or DAP errors in degrees during coast phases, depending on whether UNIV PTG Item 23 or 24 is selected. During OMS and RCS burns, the errors displayed are guidance command errors. During OMS burns, the errors reflect errors in the OMS trim positions. During +X RCS burns, the error is VGO thrust vector errors. The scale label is displayed in the right (pitch) scale only and reflects the ADI Error switch position (see A/E PFD).
- [5] Digitals – Digital values of attitude displayed on the attitude ball.

## SYSTEM STATUS DISPLAY WITH CST MENU

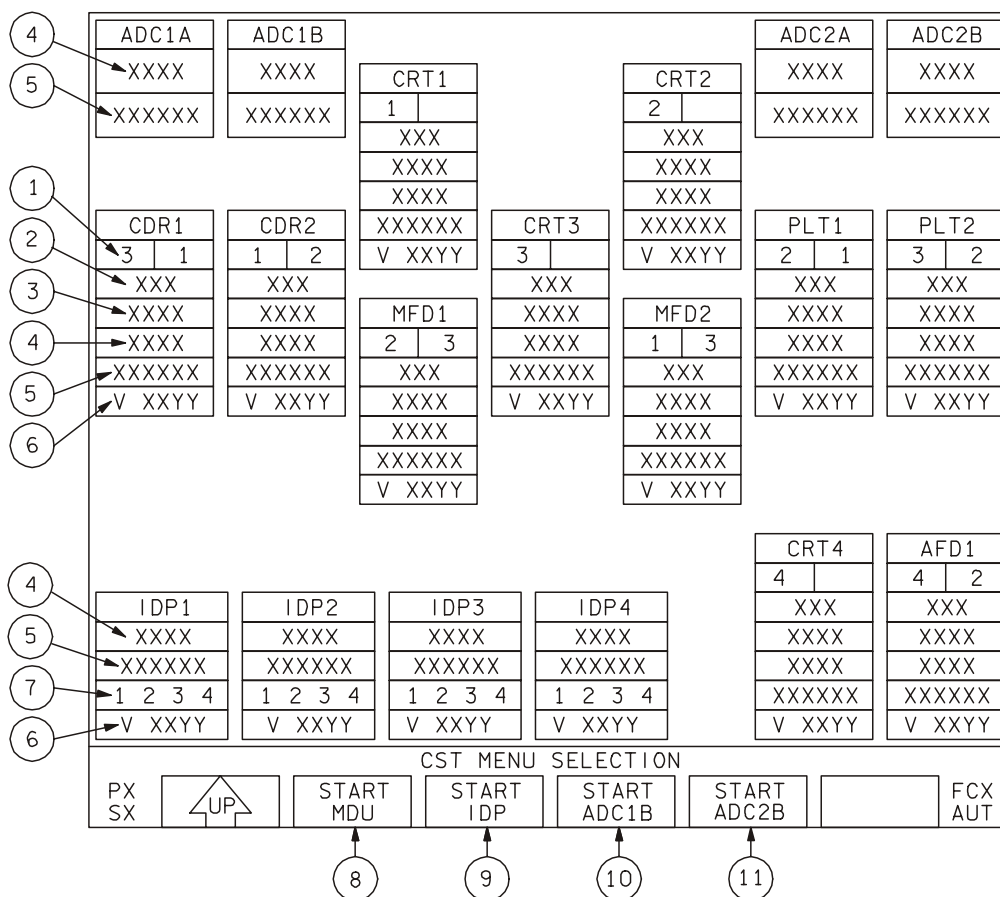

48017614\_110. PNL 1

NO.	DISPLAY PARAMETER	UNITS	DISPLAYED RANGE
1	Identifies IDPs connected to PRI/SEC ports	N/A	1-4
2	Identifies flight critical bus selected for the MDU	Text	FC1, FC2, FC3, FC4
3	Identifies the MDU port reconfiguration mode	Text	"AUTO" or "MAN"
4	Built In Test Summary (Operational Self Test) results	Hex	0000 - FFFF
5	Dump Status or Comprehensive Self Test Results (and Power On Self Test for ADC)	Text/Hex	"NO-CST", "EDUMP", "RDUMP", or 000000-FFFFFF
6	Identifies SW version number	Vxxyy	XX = version number YY = revision number
7	Identifies flight-critical buses selected for the IDP (selected buses are highlighted)		

**[1]** A blue background indicates the MDU or ADC is active and commanded by the IDP selected. The commanding IDP will also have a blue background.

For an MDU that is communicating with but not commanded by the IDP selected, a black background will be displayed. In addition, the communicating IDP (without control) will only display port reconfiguration mode data for that MDU.

**[2]** The Flight Critical (FC) Bus Selection determines which FC bus the commanding IDP will use as a data source for flight instrument displays on this MDU.

- [5]** "NO-CST" will be displayed for an IDP or MDU that a CST has not been performed on. The power on self-test (POST) and CST are identical for an ADC.
- [6]** Each IDP can communicate over a maximum of 2 FC buses at a time.
- [7]** Dump EEPROM Status is only available for IDPs and MDUs. Dump RAM status is available for ADCs, IDPs, and MDUs.
- [8]** START MDU – Selecting the edge key starts the CST on the MDU being utilized. The MDU CST performs extensive tests on MDU hardware functions. The MDU CST provides testing for all memories, processor video circuitry, display screen, processor error induction, as well as wraparound Inputs and Outputs. During the MDU CST, the MDU displays a red, green, and a blue color scale, an all white display, a rolling ADI, and finally a black display with white dots above each edge key. Each edge key should be depressed for successful MDU CST completion. An MDU CST will erase all previous MDU CST values.
- [9]** START IDP – Selects the IDP Interactive CST menu. An MDU CST will erase all previous MDU CST values.
- [10]** START ADC1X – ADC CST will be activated. The START ADC1X edge key button will be blank if the ADC is not communicating with the IDP being utilized or if the ADC CST is in progress (X=A for IDP, or X=B for IDPs 3 or 4). The ADC CST performs an extensive test of the ADC hardware and CPU resources. This includes testing of the ADC A/D converter chip, SRAM, scrub circuitry, and watchdog timer, as well as the error detection and annunciation circuitry (EDAC). An ADC CST will erase the previous ADC POST or CST results.
- [11]** START ADC2X – ADC CST will be activated. The START ADC2X edge key button will be blank if the ADC is not communicating with the IDP being utilized or if the ADC CST is in progress (X=A for IDPs 1 or 2, X=B for IDPs 3 or 4). The ADC CST performs an extensive test of the ADC hardware and CPU resources. This includes testing of the ADC A/D converter chip, SRAM, scrub circuitry, and watchdog timer, as well as the EDAC. An ADC CST will erase the previous ADC POST or CST results.



**SYSTEM STATUS DISPLAY WITH IDP INTERACTIVE CST**

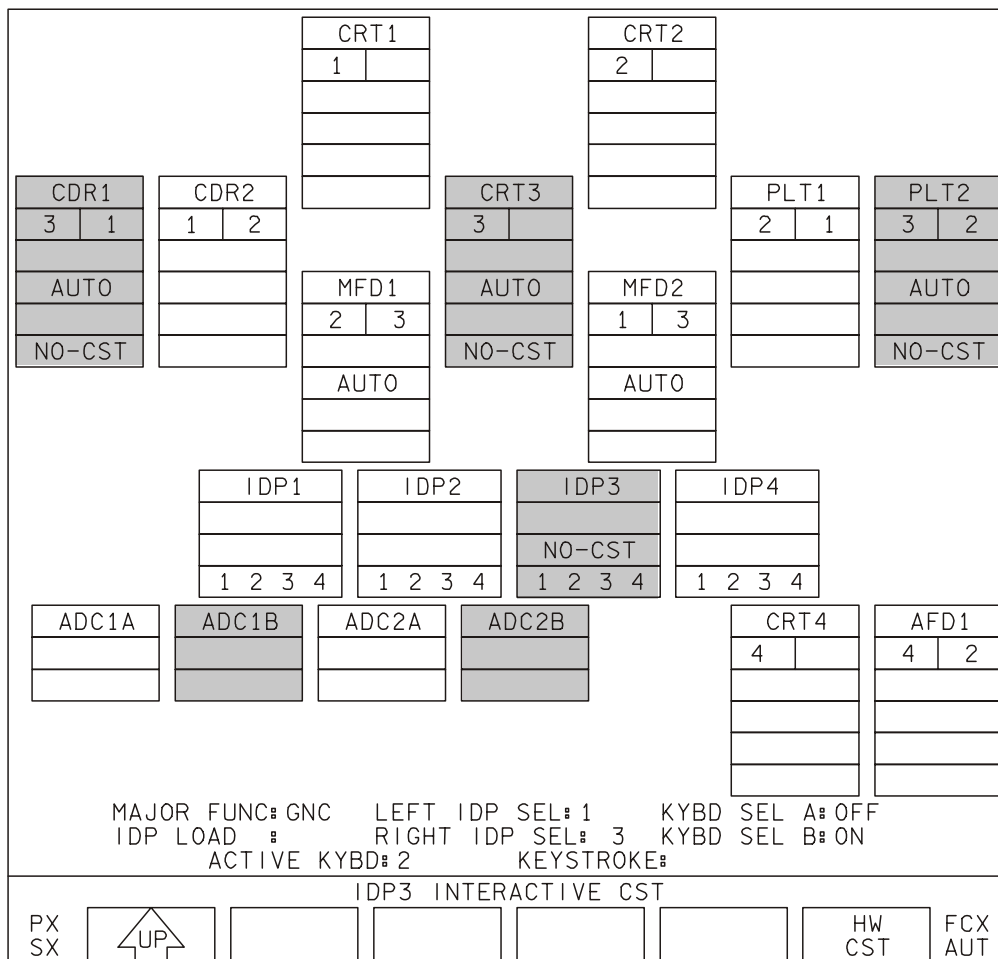

48017615\_101. PNL: 2

NO.	DISPLAY PARAMETER	UNITS	DISPLAYED RANGE
1	HW CST edge key		
2	MAJOR FUNC		GNC,SM,PL
3	IDP LOAD		blank, LOAD
4	LEFT IDP SEL		1,3
5	RIGHT IDP SEL		2,3
6	KYBD SEL A		ON,OFF
7	KYBD SEL B		ON,OFF
8	ACTIVE KYBD		1,2,3
9	KEYSTROKE		Name of key pressed on active DPS keyboard for this IDP

**[3]** The Hardware (HW) Comprehensive Self Test (CST) of the IDP performs an extensive test of the IDP hardware and processor and reloads the IDP. The test includes testing of the IDP memories, circuitry, internal timers, and keyboard input receivers, as well as wraparound inputs and outputs.

When the IDP Interactive CST menu is displayed, all MDUs except the MDU being used to activate the IDP CST will display an “IDP CST in PROGRESS” message and the IDP does not interact with any GPCs. In addition, the IDP CST value will go blank until the completion of the test, effectively erasing its previous value. Upon completion of the IDP CST, all affected MDUs will return to their original displays and default edge key menus.



FILE PATCH DISPLAY

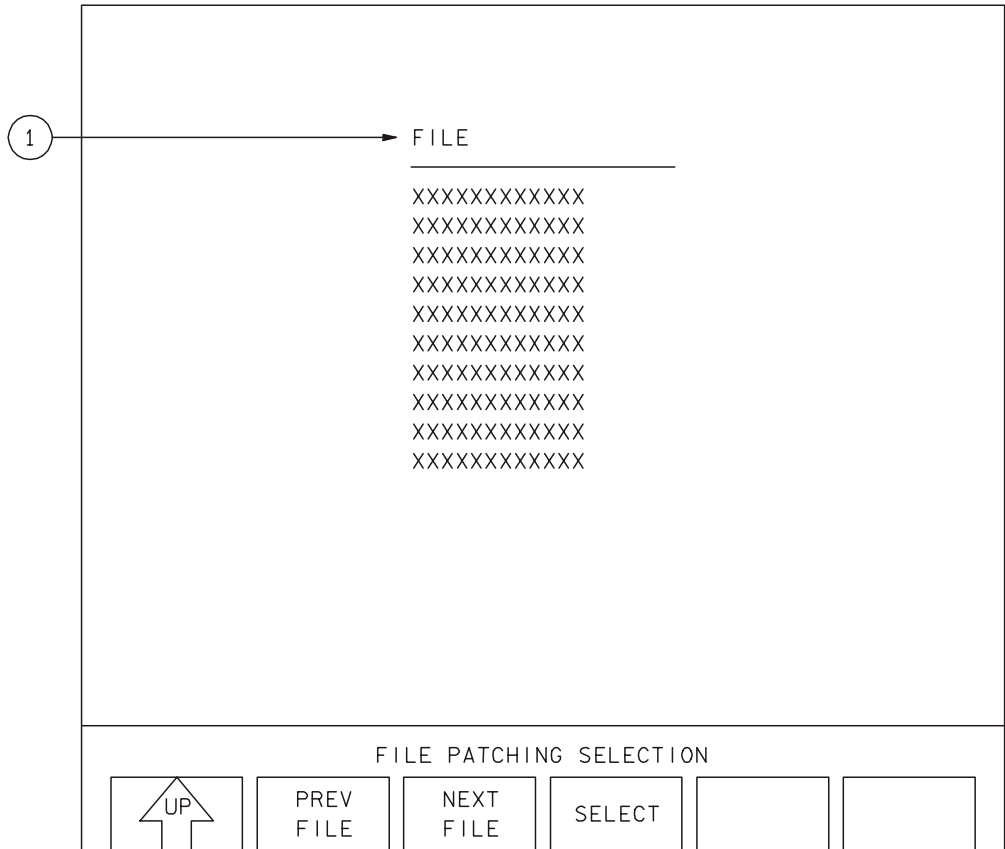

48017608\_101.PNL: 1

NO.	DISPLAY PARAMETER	UNITS	DISPLAYED RANGE
1	File Patch Name	Text	

PROG LOAD DISPLAY

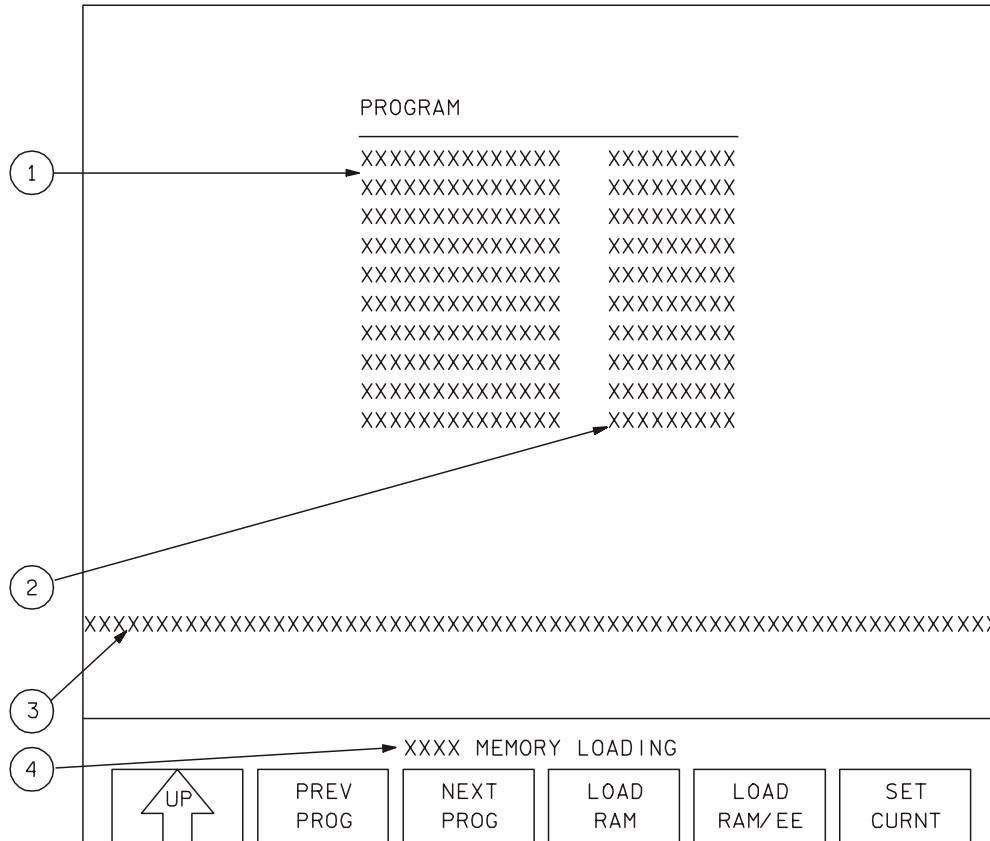

48017606\_101. PNL; 1

NO.	DISPLAY PARAMETER	UNITS	DISPLAYED RANGE
1	Names of Program Loads	Text	
2	Program Status Indication	Text	"CURRENT" or "DEFAULT"
3	Memory Loading Status Line	Text	
4	Selected LRU Name	Text	

# FAULT SUMMARY DISPLAY

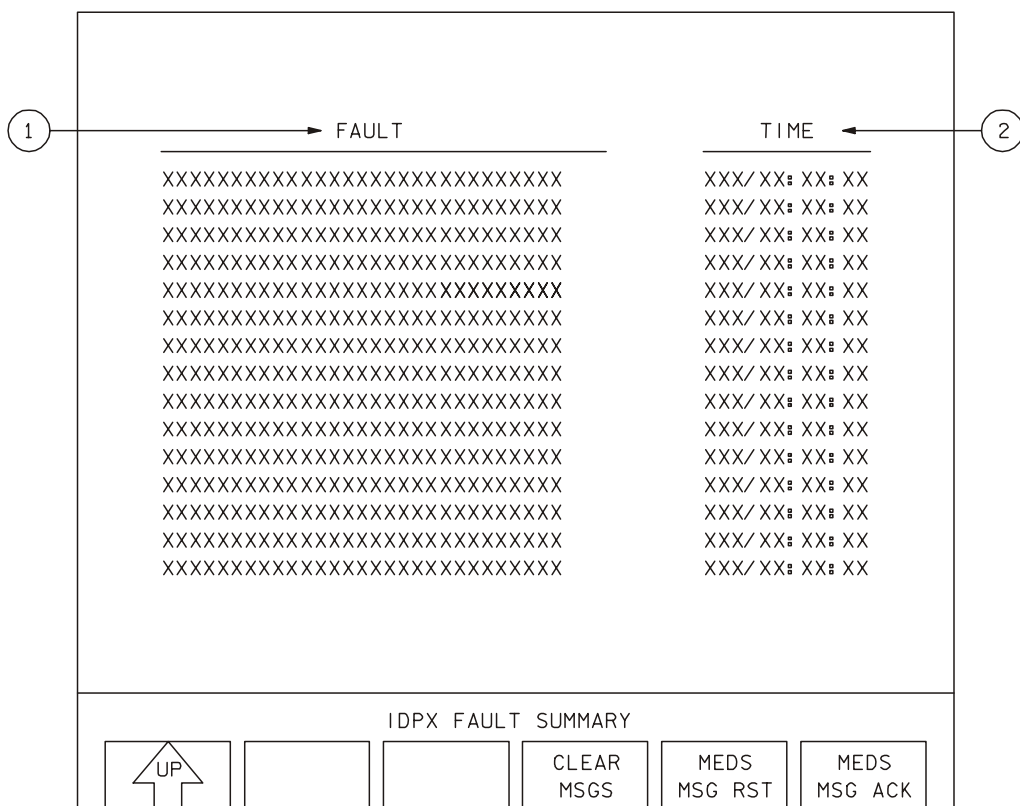

48017609\_101.PNL: 2

- [3]** CLEAR MSGS – Clears all MEDS on the MEDS FAULT SUMMARY display and MEDS message line for all MDUs commanded by this IDP. MEDS messages default to a CRT MDU, if available on this IDP.
- [4]** MEDS MSG RST – Clears the MEDS message line for all MDUs commanded by this IDP, but does not change the list of MEDS messages on the MEDS FAULT SUMMARY display.
- [5]** MEDS MSG ACK – Acknowledges a single MEDS message on the MEDS message line (each time the edge key is pressed) for all MDUs commanded by this IDP. This does not change the list of MEDS messages on the MEDS FAULT SUMMARY display.

When a MEDS message is annunciated, the message is displayed with blinking text on the MEDS message line. Any subsequent message is reflected by a number increment (in parentheses) to the right of the MEDS message text on the MEDS message line. The oldest unacknowledged message appears on the MEDS message line. The initial selection of the MEDS MSG ACK edge key stops the first message from blinking. Each additional press of the MEDS MSG ACK key results in the removal of the MEDS message displayed on the MEDS message line; however, the messages are not removed from the MEDS FAULT SUMMARY display.

NO.	DISPLAY PARAMETER	UNITS	DISPLAYED RANGE
1	Fault	Text	
2	Time		GMT of fault detection

This Page Intentionally Blank

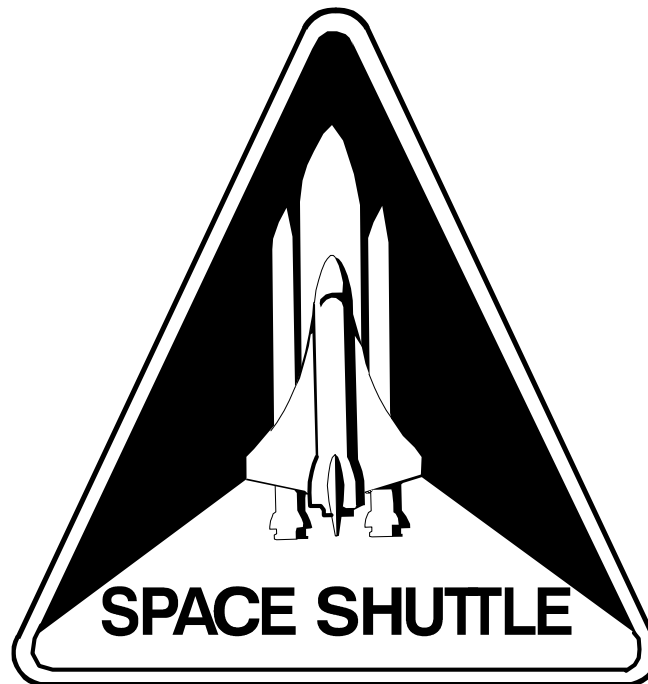

**DPS**  
**DICTIONARY**

**STS**  
**ALL**