

Navigation Overview

NAV 2102B

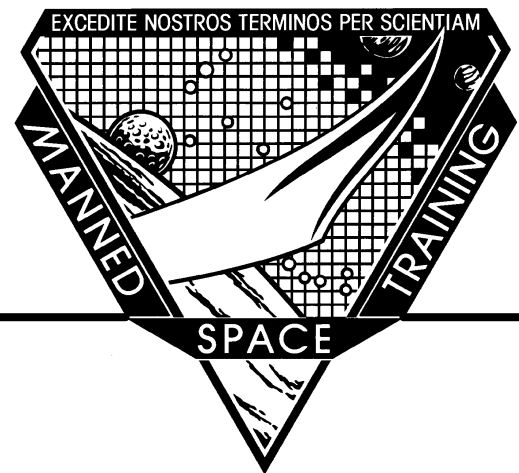

**Mission Operations Directorate
Space Flight Training Division
Computer and Navigation
Training Branch**

March 1995

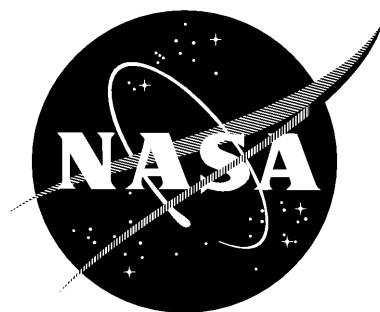

National Aeronautics and
Space Administration

Lyndon B. Johnson Space Center
Houston, Texas

Navigation Overview

NAV 2102B

March 1995

Prepared by



Gregory J. Byrne
Shuttle DPS and Navigation Group

Approved by

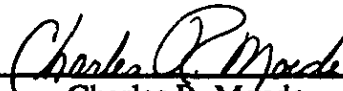

Charles R. Moede
Lead, Shuttle DPS and Navigation Group



Peter J. Beauregard
Chief, Computer and Navigation
Training Branch

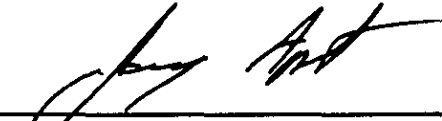

Jay Apt
Training Representative, Astronaut Office

Mission Operations Directorate
Space Flight Training Division
Computer and Navigation Training Branch

Technical Support

Subject Matter Expert

Gregory J. Byrne

Technical Assistance

Robert J. Mahoney
Robert D. Banfield

Foreword

The content of this document was provided by the Shuttle DPS and Navigation Group, Computer and Navigation Training Branch, Space Flight Training Division, Mission Operations Directorate (MOD), Lyndon B. Johnson Space Center (JSC), National Aeronautics and Space Administration (NASA). Technical documentation support was provided by Integrated Documentation Services (IDS), Hernandez Engineering, Inc. Any questions concerning this training manual or any recommendations should be directed to the training manual book manager, Gregory J. Byrne, at DT23, 244-7209.

This material is for training purposes only and should not be used as a source of operational data. All numerical data, displays, and checklist references are intended as examples. To determine any prerequisites before using this document, consult the applicable Certification Plan. For shuttle manuals, consult the Flight Operations Support Personnel Training Guide (Blue Book) or the Crew Training Catalog. For Space Station manuals, consult the appropriate Space Station Certification Training Guide or Training Administration Management System (TAMS). The applicable training package should be studied before attending any classroom session or lesson for which this is a prerequisite.

A Training Materials Evaluation is included at the end of this document. Inputs on this sheet will be used to evaluate the lesson material. You do not need to sign the sheet.

Contents

Section	Page
Preface	xi
1 Coordinate Systems	1-1
Objectives	1-1
Overview	1-1
Body Axes Coordinate System	1-1
Mean of 1950 Coordinate System	1-2
Earth-Fixed Coordinate System	1-3
J2000 Coordinate System	1-4
Starball Coordinate System	1-4
Local Vertical/Local Horizontal Coordinate System	1-6
UVW Coordinate System	1-7
Runway Coordinate System	1-8
Questions	1-9
2 State Vector Propagation	2-1
Objectives	2-1
Overview	2-1
Inertial Measurement Unit	2-2
Equations of Motion; Super-G Navigation	2-4
Modeled Forces	2-7
Gravity Model	2-7
Drag Acceleration Model	2-8
Vent Force Model	2-11
State Vector Schemes	2-12
Single State Vector Scheme	2-12
Three State Vector Scheme	2-14
State Vector Prediction Across OPS Transitions	2-16
Questions	2-17
3 State Vector Filtering	3-1
Objectives	3-1
Overview	3-1
Entry, RTLS, and Pre-Land Navigation Aids	3-1
Drag Altitude (Drag H)	3-1
Tactical Air Navigation System	3-2
Air Data System	3-4
Microwave Landing System	3-4
Rendezvous Navigation Aids	3-6
Star Tracker	3-6
Crew Optical Alignment Sight	3-7
Rendezvous Radar	3-8

Section	Page
Kalman Filtering	3-9
Questions	3-17
4 State Vector Updates	4-1
Objectives	4-1
Overview	4-1
Whole State Vector Update	4-1
Delta State Vector Update	4-2
Voice Delta State Vector Update	4-3
Zero Delta State Vector Update	4-4
PASS-to-BFS State Vector Transfer	4-6
Questions	4-9
5 Navigation by Mission Phase	5-1
Objectives	5-1
Overview	5-1
Ascent Navigation	5-1
Orbit (Nonrendezvous) Navigation	5-2
Rendezvous Navigation	5-3
OPS 3 Navigation	5-5
Overview	5-5
Deorbit Prep to Entry Interface	5-6
Entry Interface to Landing	5-8
RTLS Navigation	5-16
BFS Differences	5-17
Questions	5-19
Appendix	
A Acronyms and Abbreviations	A-1
B Answers	B-1

Figures

Figure		Page
1-1	Body axes coordinate system	1-2
1-2	Mean of 1950 coordinate system	1-2
1-3	Starball coordinate system	1-5
1-4	LVLH coordinate system	1-6
1-5	Example of LVLH attitude hold	1-7
1-6	UVW coordinate system	1-7
1-7	Runway coordinate system	1-8
2-1	Inertial measurement units	2-2
2-2	IMU platform assembly	2-3
2-3	Super-G algorithm using IMU-sensed acceleration	2-6
2-4	IMU-sensed acceleration versus drag acceleration model	2-9
2-5	REL NAV display – AVG G item	2-10
2-6	IMU ALIGN display – NAV ΔV threshold	2-11
2-7	Single state vector scheme	2-13
2-8	Entry three state vector scheme	2-15
3-1	Drag H calculation	3-2
3-2	TACAN slant range and bearing	3-3
3-3	TACAN cone of confusion	3-4
3-4	MLS slant range, azimuth, and elevation	3-5
3-5	Star Tracker location	3-6
3-6	S TRK/COAS CNTL display – target track and break track	3-7
3-7	COAS locations	3-8
3-8	Calculation of the TACAN range Residual	3-10
3-9	Standard deviation σ_s and variance σ_s^2 for the Entry sensor parameters	3-12
3-10	A representation of Kalman filter updating of the orbiter state vector with sensor data	3-13
3-11	HORIZ SIT display – Residuals, Ratios, and filter controls	3-14
4-1	Item entries for a “voice” delta state vector update	4-4
4-2	BFS HORIZ SIT display – PASS/BFS SV XFER items	4-6
5-1	IMU ALIGN display – IMU-sensed accelerations	5-3
5-2	REL NAV display	5-4
5-3	HORIZ SIT display – landing site, runway, and TACAN station select	5-6
5-4	Entry Checklist Landing Site Table	5-7
5-5	Entry Checklist callout at approximately EI – 15 minutes to verify Nav sensor configuration	5-8
5-6	Entry Nav aid sensors as a function of altitude and Mach for a typical Entry (shaded areas indicate sensor use for state vector filtering)	5-9
5-7	HORIZ SIT display – Nav filter controls and TACAN data	5-10
5-8	Entry Maneuvers cue card	5-11
5-9	OVERRIDE display – ADTA data	5-15

Section 1

Coordinate Systems

Objectives

Upon completion of this section, you should be able to

- Describe the reference frames and axes orientations of the following most commonly used coordinate systems:
 - Body axes
 - Mean of 1950 (M50)
 - Local Vertical/Local Horizontal (LVLH)

Overview

The position and velocity of the shuttle, referred to as the shuttle state vector, must be uniquely defined in terms of an inertial coordinate system – a reference frame which is neither rotating nor accelerating. This is because onboard navigation software propagates the state vector using Newton’s laws of motion, which are valid only in an inertial coordinate system. The onboard navigation system uses the M50 inertial coordinate system.

Some quantities are much easier to define and some computations are considerably simpler if done in other coordinate systems. For example, when landing the shuttle, for some applications it is more useful to give the position of the shuttle relative to the runway than it is to give its position in an inertial coordinate system fixed in space. Thus, the onboard navigation system uses a number of different coordinate systems for various applications. The coordinates in one coordinate system can be expressed in another coordinate system by using coordinate transformations that are resident in the navigation software.

This manual does not discuss all the coordinate systems used by the navigation software or the coordinate transformations. However, a few coordinate systems do need to be understood because they appear to the crew on certain dedicated displays and Cathode-Ray Tube (CRT) displays. Also, they may be used to clarify certain aspects of navigation that are discussed later. This section provides brief descriptions of the three most often referenced coordinate systems: body axes system, M50 inertial system, and LVLH, as well as less frequently used coordinate systems.

Body Axes Coordinate System

The orbiter body axes have their origin at the orbiter’s center of mass. Their orientation is shown in Figure 1–1. The body axes coordinate system is defined as follows:

The X-axis is positive toward the center of the nose and parallel to the longitudinal axis of the orbiter; the Y-axis is positive out the starboard wing and perpendicular to the X-axis; and the Z-axis completes the right-handed orthogonal system and is positive through the belly of the orbiter.

Note: Vehicle pitch is a rotation about the Y–body axis; vehicle roll is a rotation about the X–body axis; and vehicle yaw is a rotation about the Z–body axis.

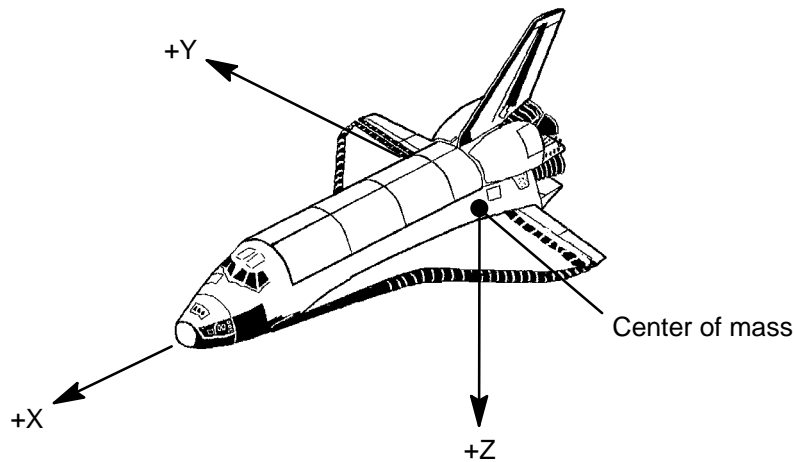

td212_001

Figure 1–1. Body axes coordinate system

Mean of 1950 Coordinate System

The inertial coordinate system currently used by the onboard navigation software is the Mean of 1950 coordinate system, which is usually referred to as the M50 coordinate system. The shuttle’s position and velocity are calculated relative to M50 coordinates in both the Primary Avionics Software System (PASS) and Backup Flight System (BFS) General Purpose Computers (GPCs).

M50 is a geocentric–equatorial coordinate system: the origin is at the center of the Earth; the X–Y plane is in the plane of the Earth’s Equator; and the Z–axis is along the Earth’s axis of rotation. The axes point toward fixed reference points in space, as shown in Figure 1–2.

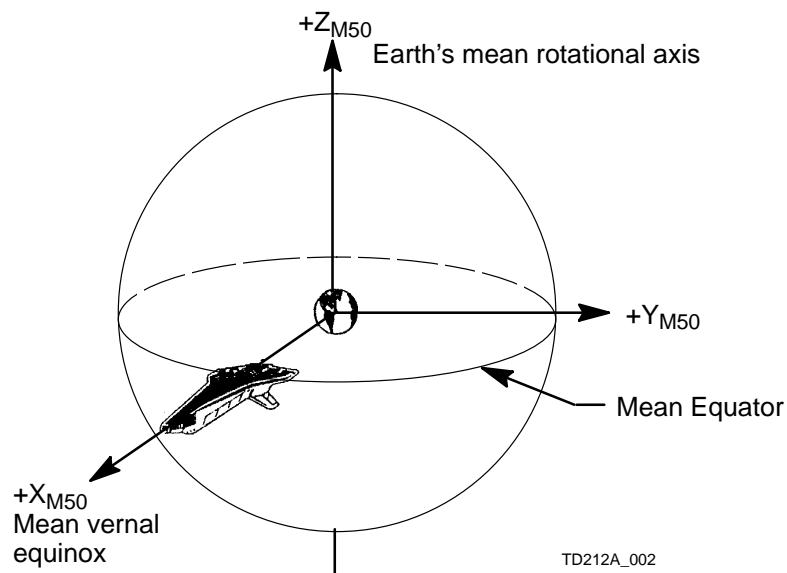

TD212A_002

Figure 1–2. Mean of 1950 coordinate system

The reference point for the +X axis is the mean position of the vernal equinox for the year 1950. The vernal equinox is defined as the apparent point on the celestial sphere of the center of the Sun at the instant the Sun crosses the Earth's Equator on the first day of spring. In celestial coordinates, the vernal equinox is defined as Right Ascension (RA) and Declination (DEC) of (0, 0). The vernal equinox is sometimes referred to as the "first point of Aries" because in ancient times its position was within the constellation Aries. However, due to the Earth's precession (the Earth motion that causes the North Pole to trace out a full circle in space every 26,000 years), the modern day vernal equinox has precessed into the constellation Pisces. An additional motion, nutation, is an Earth wobble with an amplitude of 9 minutes of arc and a period of 18.6 years. The "Mean" of 1950 refers to the average of the periodic motion of nutation.

The reference point for the +Z axis of M50 is the apparent point on the celestial sphere made by the line extending out of the mean position of the North Pole, again for the year 1950. The +Y axis of M50 completes the right-handed orthogonal system. The crew can view the orbiter's M50 position and velocity components on the GNC SPEC 34 display while on orbit.

The orbiter's attitude in inertial space can also be defined relative to the M50 reference frame. When the orbiter's body axes are aligned with the M50 coordinate axes (that is, the X, Y, Z body axes are parallel to the respective X, Y, Z M50 axes), the orbiter M50 attitude is by definition a pitch (P), yaw (Y), roll (R) of (0, 0, 0). In Figure 1-2, the orbiter is shown in its (0, 0, 0) M50 attitude. Given this reference attitude, any orbiter M50 attitude (P, Y, R) can be defined as equivalent to a sequence of vehicle pitch, yaw, and roll rotations starting from the (0, 0, 0) reference attitude. More details on orbiter attitude determination can be found in the Attitude and Pointing Handbook.

The orbiter M50 attitude can be viewed by the crew on the Attitude Director Indicator (ADI), when the ADI attitude switch is in the "INRTL" position. The Computer Based Training (CBT) lesson on GNC Dedicated Displays gives details and examples on the use of the ADI. The orbiter M50 attitude can also be viewed on the Universal Pointing (UNIV PTG) and Inertial Measurement Unit (IMU) ALIGN CRT displays.

Earth-Fixed Coordinate System

The onboard state vector is calculated in M50 coordinates, which are referenced to the Earth's orientation in the year 1950. The state vector is transformed by the onboard navigation software to coordinates in the Earth-Fixed coordinate system for various applications that reference the Earth's surface. The Earth-Fixed coordinate system is also referred to as the Greenwich True-of-Date coordinate system. "True of date" means that it is referenced to the current orientation of the Earth: the origin is the center of the Earth; the X-Y plane is the Earth's equator; the +X axis points toward the prime meridian; and the Z-axis is along the Earth's axis of rotation. Navigation software provides the transformation matrix to convert from M50 to Earth-Fixed coordinates. The Earth-Fixed coordinates are subsequently transformed to other Earth-referenced coordinates, such as runway or geodetic coordinates, as required.

The M50 to Earth-Fixed transformation matrix takes into account the precession and nutation motions of the Earth over the time period from January 1, 1950 (the epoch for M50) to a reference time that is initial-loaded (I-loaded) in the onboard software. As a result of precession, the +X axis of M50 differs from the "true-of-date" +X axis by less than 1°. This difference is accommodated by the transformation matrix. Although the correction is small, it is not

negligible for certain applications that require an accurate Earth reference, such as in the state vector transformation from M50 to runway coordinates. As another example, an onboard Earth gravity model is used by navigation software to calculate the gravitational acceleration due to the Earth's equatorial bulge for state vector calculations (see Section 2). Due to the Earth's precession, the bulge is no longer in the M50 X–Y plane. Hence an M50 to Earth–Fixed transformation allows a more accurate calculation of the orbiter's position relative to the bulge.

The transformation matrix used to convert the state vector from M50 to Earth–Fixed coordinates must account for Earth precession and nutation, and the Earth's rotation angle from the I–load reference time to the current mission time. Therefore, the transformation matrix accounts for the combination of Earth Rotation, Nutation, and Precession (RNP); thus, it is referred to as simply the RNP matrix.

The I–load reference time of the RNP matrix is known as the matrix time of epoch. The RNP matrix is updated in the navigation software for each mission so that, typically, the RNP is current within 2 months of the mission launch date. In other words, the onboard RNP matrix time of epoch is usually within ± 2 months of the launch date. The Earth precession and nutation motions over a few weeks are simply not significant enough to warrant the most up–to–date RNP matrix for onboard computations. However, Mission Control Center (MCC) generates a new RNP matrix approximately every 6 hours for its calculations.

J2000 Coordinate System

Analogous to the M50 system is the J2000 inertial coordinate system. The J2000 coordinate axes are defined in the same way as M50 axes, except the J2000 axes are based on what the Earth's orientation will be in the year 2000. As a result of the Earth's precession, the +X axes of M50 and J2000 differ by about 0.7° .

The J2000 coordinate system provides more accuracy than the M50 system for two reasons. First, to compute the RNP matrix, there are internationally agreed upon standard equations (defined around 1950) that account for the wobble of the Earth. The farther we are from 1950, the more wobble the RNP matrix must account for. Therefore any inaccuracies in the modeling of this wobble will not be as large using J2000 since we do not have to model the Earth's motions for as long a time. Secondly, the constants used to describe this wobble are known with much more accuracy for J2000 than they were known when the M50 system was defined. Thus, with J2000, not only is the Earth's wobble modeled over a shorter time period, but it is modeled with more accurate constants.

The orbiter's onboard state vector is calculated in M50 coordinates, and MCC also uses M50 for its shuttle state vector calculations. Other NASA facilities supply planetary and solar positions to JSC in J2000 coordinates, and these are converted in–house to M50. The greater accuracy of J2000 would be significant for shuttle missions of duration greater than 6 months. The International Space Station state vector will be calculated in J2000 coordinates.

Starball Coordinate System

Early in the space program there was concern about the ability of crewmembers in space to locate and identify stars so that the attitude and position of their vehicle could be determined in certain failure situations. A simple system was needed that would allow the crewmembers to look up the position of a star on a star chart and then maneuver their vehicle to point at it. The

solution was to define an inertial reference frame rotated 90° from M50; this is the Starball coordinate system, as shown in Figure 1-3.

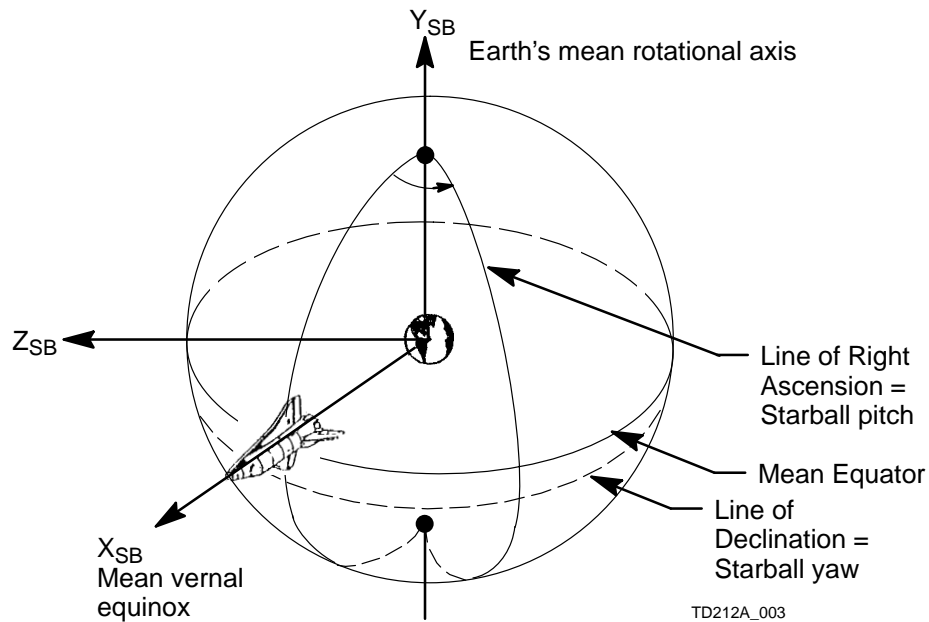

Figure 1-3. Starball coordinate system

The Starball coordinate system is rotated +90° from the M50 coordinate system about the X-axis. In this manner, the X-axis of the starball system is coincident with X-axis for M50. However, the Y-axis for Starball points out the Earth's North Pole in the direction of M50's Z-axis, and the Starball Z-axis completes the right-handed system.

If we align the orbiter's body axes with the Starball axes, we define the P, Y, R Starball attitude of (0, 0, 0), as shown in Figure 1-3. To define any Starball attitude is equivalent to an orbiter pitch, yaw, roll sequence starting from the (0, 0, 0) attitude. With the Starball attitude defined in this way, the Starball pitch and yaw are equal to the celestial coordinates Right Ascension and Declination, respectively. For example, if the crew maneuvers the orbiter to a Starball attitude of $P = 50$ and $Y = 30$, then the nose of the orbiter (+X body axis) points directly to (RA, DEC) = (50, 30). Although Starball provides a handy means for the crew to determine the shuttle attitude relative to the stars, it is rarely used. If the Star Trackers cannot be used for an IMU alignment, Starball may be used by the crew to assist in a manual maneuver to collect star data for the alignment, using the Head Up Display (HUD) or Crew Optical Alignment Sight (COAS).

In Operational Sequence (OPS) 2 the crew can view the orbiter's Starball attitude on the ADI by using the "REF" position on the ADI attitude switch. The Starball reference system is loaded into the GPCs during the transition to OPS 2. The ADI software uses a transformation matrix (RELMAT) to convert the orbiter's M50 attitude to Starball for display.

If an ADI attitude switch is in the "REF" position and the crew depresses an "ATT REF" pushbutton, the crew loses the ability to view Starball on the ADIs. By depressing the ATT REF pushbutton, the RELMAT is redefined such that the ADIs show P, Y, R = (0, 0, 0) for the current attitude (the ADIs are said to be "REF'ed"). Subsequent orbiter rotations will cause the ADIs to rotate away from (0, 0, 0). Hence the crew may use the REF'ed ADI (0, 0, 0) attitude as a "fly-to" reference to return to the original attitude. Once the ADIs have been REF'ed, if the

crew subsequently desires to display the Starball attitude of the orbiter on an ADI, the Starball RELMAT must be reloaded into the software. This procedure is done either by ground uplink or by performing an OPS transition from GNC OPS 2 to GNC OPS 8 and then back to GNC OPS 2 to reload the Starball RELMAT from the Mass Memory Unit (MMU) on the OPS 2 transition.

Local Vertical/Local Horizontal Coordinate System

As the M50 and Starball frames were chosen for their ease in maintaining star–relative orientations, so was the LVLH system chosen for maintaining Earth–relative orientations. The LVLH reference frame rotates with the orbiter’s position vector (Figure 1–4), with the origin at the orbiter’s center of mass (in rendezvous, the LVLH frame most useful is centered at the target’s center of mass).

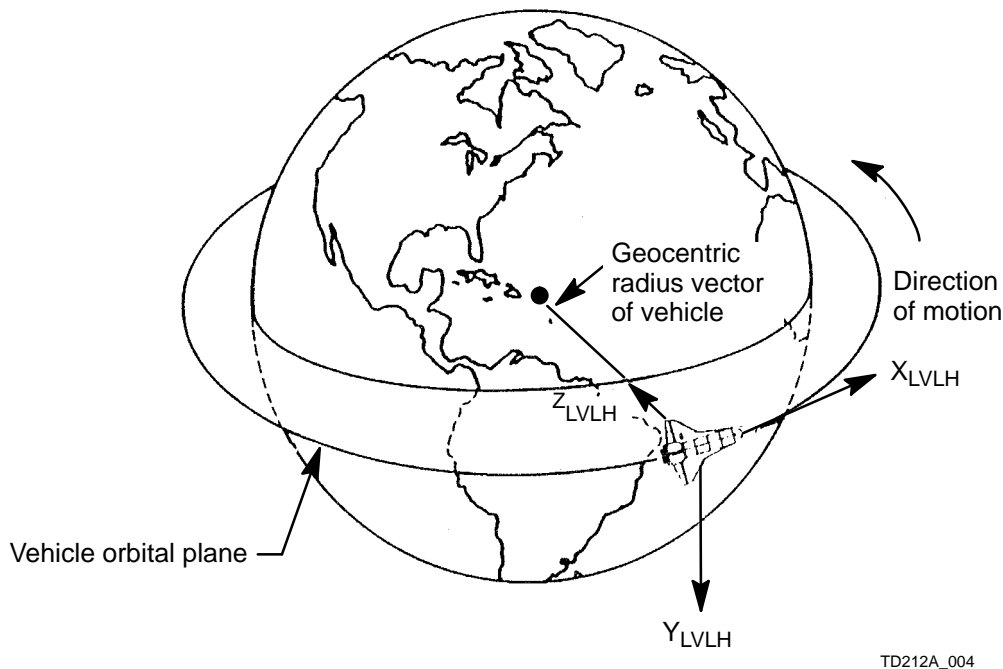

Figure 1–4. LVLH coordinate system

The LVLH +Z axis (local vertical) points from the origin to the center of the Earth. The +Y axis is pointed in the direction of the negative angular momentum vector of the vehicle’s orbit. The +X axis (local horizontal) completes the orthogonal coordinate system.

The +X axis lies in the orbit plane and points identically in the direction as the velocity vector for perfectly circular orbits. Operationally, since shuttle orbits are very nearly circular, the +X axis is very nearly in the direction of the velocity vector for all shuttle orbits.

When the orbiter is in an LVLH P, Y, R = (0, 0, 0) attitude, the belly points to the center of the Earth; the nose points in the local horizontal direction; and the right wing points perpendicular to the plane of the orbit towards the south side of the orbit. The orbiter is shown in its (0, 0, 0) LVLH attitude in Figure 1–4. That is, in an LVLH (0, 0, 0) attitude, the orbiter is flying in an “airplane” orientation. When the orbiter is placed in a specific LVLH attitude and commanded to maintain LVLH attitude hold, it will remain in the same Earth–facing orientation as it orbits the Earth (Figure 1–5).

The orbiter LVLH attitude can be viewed by the crew on the ADI when the ADI attitude switch is in the “LVLH” position. The use of the ADI, with examples, can be found in the GNC Dedicated Displays CBT lesson.

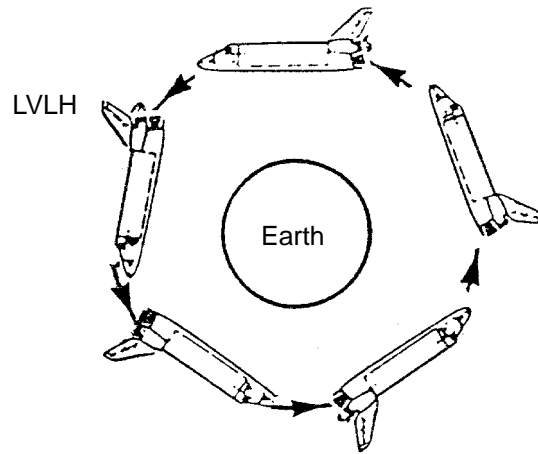

TD212A_005

Figure 1-5. Example of LVLH attitude hold

UVW Coordinate System

Similar to LVLH is the radial, downtrack, and crosstrack components (UVW) system shown in Figure 1-6. This is sometimes called the up-downrange-crossrange system since this is descriptive of the directions of the axes. The UVW coordinate system is used to display PASS/BFS state vector transfers on BFS SPEC 50, discussed in Section 4.

The origin of this system is any point of interest along the vehicle orbit. The U-V plane is the instantaneous orbit plane at epoch. The U-axis lies along the geocentric radius vector to the vehicle and is positive radially outward (\approx up). The W-axis lies along the instantaneous orbital angular momentum vector at epoch and is positive in the direction of the angular momentum vector (\approx crossrange). The V-axis completes a right-handed system (\approx downrange).

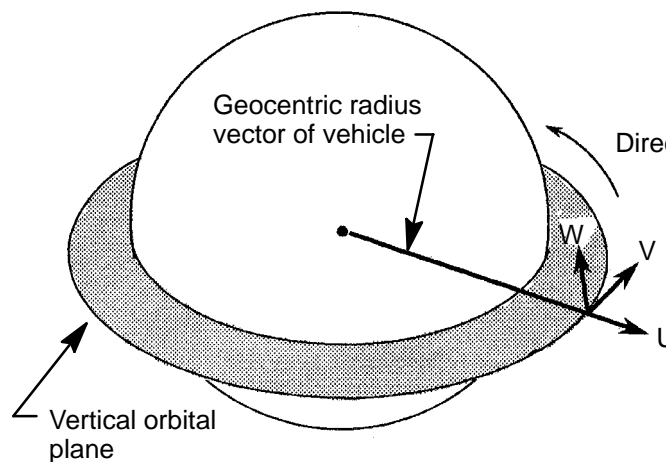

td212_006

Figure 1-6. UVW coordinate system

Runway Coordinate System

Another example of an Earth-referenced coordinate system is the runway coordinate system, as shown in Figure 1-7. This system is used for expressing state vector corrections during dynamic phases of flight (Ascent and Entry). These state vector corrections are called “Delta State Updates” and are described in detail in Section 4.

The origin is the center of the runway at the approach threshold. The Z-axis is normal to the runway centerline and positive toward the center of the Earth. The X-axis is perpendicular to the Z-axis and lies in a plane containing the Z-axis and the runway centerline (positive in the direction of landing). The Y-axis completes the right-handed system. A_{LF} is the runway azimuth measured in the X-Y plane from true north (N) to the +X axis (positive clockwise).

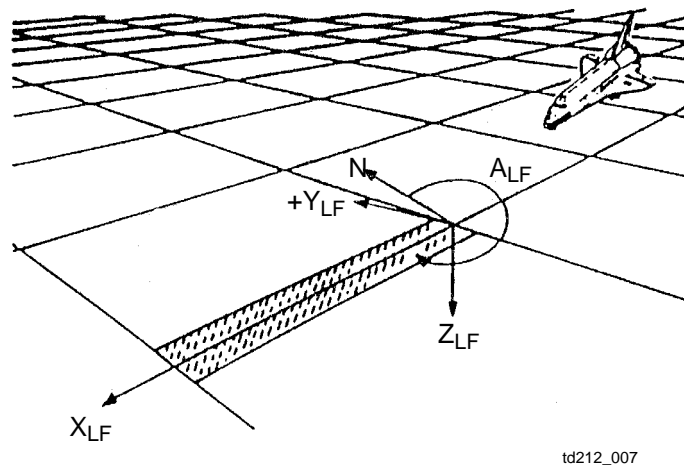

Figure 1-7. Runway coordinate system

Questions

Answers to the following questions can be found in Appendix B.

1. Name the coordinate system that is used when calculating the orbiter's state vector. Why is this system used?
2. State the origin of the shuttle body axes coordinate system. Where do the axes for this system point?
3. State the origin of the LVLH coordinate system. Where do the X, Y, and Z axes for this system point?
4. State the origin of the M50 coordinate system. Where do the X, Y, and Z axes for this system point?
5. State the usefulness to the orbiter crewmembers of the Starball coordinate system.
6. What is the RNP matrix used for?

Section 2

State Vector Propagation

Objectives

Upon completion of this section, you should be able to

- Describe the principle of operation of an IMU accelerometer
- Discuss the basic function of the Super-G navigation software
- Explain when the navigation software uses a detailed gravity model versus a simplified model for state vector propagation
- Explain when the navigation software uses modeled atmospheric drag versus IMU-sensed atmospheric drag for state vector propagation
- Describe the difference between the single state and three state vector schemes and match each scheme with a phase of flight
- Identify the principal function of Kalman filtering in the navigation software
- Illustrate the advantage of the three state vector scheme over the single state vector scheme

Overview

The shuttle state vector refers to the position and velocity of the orbiter at a given time during flight. The state vector consists of six elements: a three-component position vector R (feet) and a three-component velocity vector V (feet per second), at a time t (Greenwich Mean Time) in which the vectors are applicable. The vectors are relative to the M50 inertial coordinate system. The elements of the state vector can therefore be given as R_x , R_y , R_z , V_x , V_y , and V_z , where x , y , and z denote the M50 coordinate axes.

The state vector is calculated onboard by the navigation software in the GPCs. The various phases of shuttle flight have certain basic navigation functions in common. These common functions are discussed in this section. Subsequent sections discuss the unique functions of navigation by phase.

The navigation software employs standard equations of motion to calculate the state vector at regular time intervals, using data input from various onboard sensors. This process is referred to as state vector propagation. The primary onboard sensors, from which data are used in all flight phases, are the IMUs. Additional sensors are used for Entry, Return-to-Launch Site (RTL), Pre-land, and Rendezvous navigation to improve the accuracy of the IMU-based state vector.

Certain forces (gravity, drag, and vents) act on the vehicle (and therefore affect its state vector) but are not detected by the onboard sensors. These forces are modeled in the onboard software, and this modeling also improves the accuracy of the IMU-based state. These models are briefly described in this section.

Inertial Measurement Unit

The primary onboard sensors used to derive the shuttle state vector are accelerometers within the IMUs. There are three redundant IMUs on the orbiter, located on a navigational base 55 feet ahead of the orbiter center of gravity, as shown in Figure 2-1. Brief descriptions of their functions are included here; details can be found in the IMU 2102 Workbook.

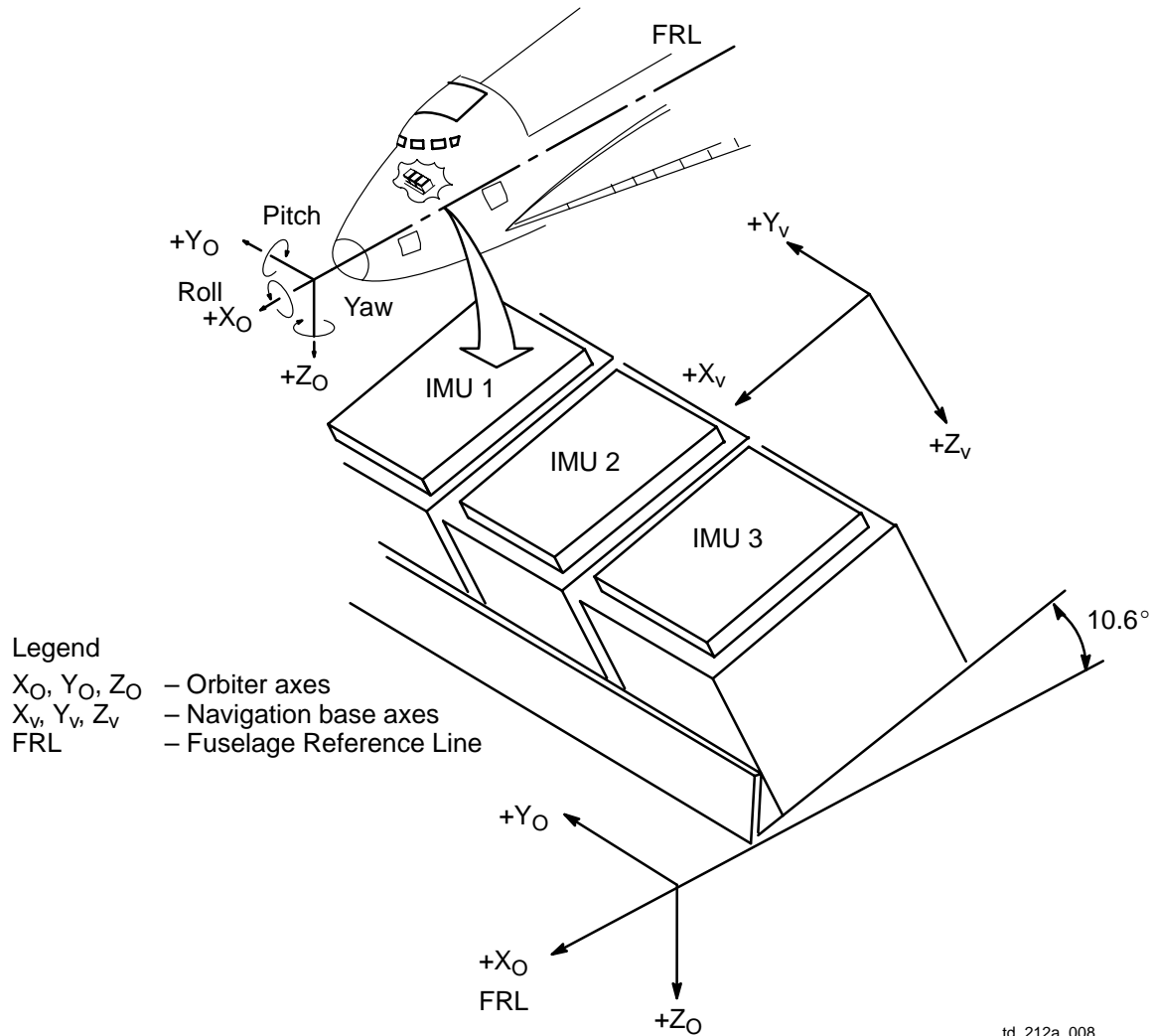

Figure 2-1. Inertial measurement units

Each IMU contains a platform that is maintained inertially stable; that is, the orientation of the platform is fixed relative to the stars. Mounted on each IMU platform are three single-axis accelerometers that sense the vector components of shuttle acceleration in inertial space (in platform coordinates), provided the IMU platforms remain in their inertial orientations. An IMU assembly is shown in Figure 2-2.

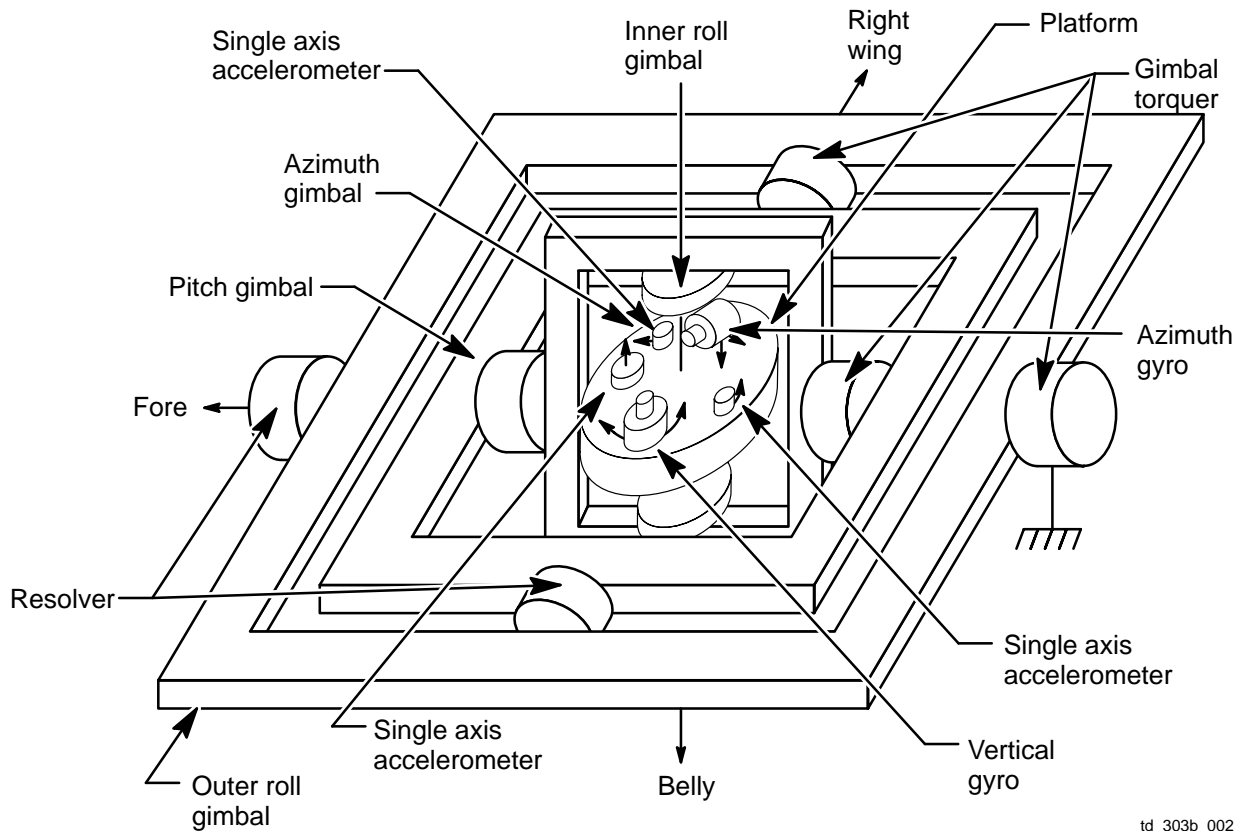

Figure 2-2. IMU platform assembly

Each accelerometer contains a pendulous mass which is free to move. An acceleration of the vehicle causes the pendulous mass to move relative to the accelerometer's casing. This motion is sensed and a voltage is applied to torquers to move the mass back to the null position. The voltage required is proportional to the acceleration.

The output of each accelerometer channel (X, Y, or Z axis in platform coordinates) is a direct current (dc) signal with an amplitude that is directly proportional to the magnitude of the shuttle acceleration along the given accelerometer axis. Each dc signal is then converted within the IMU to pulses of a frequency that is proportional to the dc amplitude; therefore, the signal frequencies are proportional to the accelerations along the respective axes. Each pulse corresponds to a change in velocity ΔV along the given axis of 1.05 cm s^{-1} . The signal pulses are then issued to three counter registers, one for each velocity component, which accumulate the ΔV_X , ΔV_Y , and ΔV_Z pulses, respectively. The signal pulses input to the registers are issued over two separate lines: one line for positive changes ($+\Delta V$) and the other for negative changes ($-\Delta V$) in velocity, corresponding to positive or negative accelerations, respectively.

The final output of each IMU is therefore the total change in each velocity component, referred to as "total velocities," accumulated in the registers over a specific time interval. The GPC software performs the task of reading the IMU total velocities at a rate of 6.25 Hertz (Hz) and transforming them from IMU platform coordinates to M50 coordinates. Note that the total velocity divided by the time interval of accumulation is equal to the average acceleration during the time interval. The sensed-acceleration output of a typical accelerometer is accurate to approximately $\pm 40 \sigma g$ per axis.

The GPCs use the IMU-sensed acceleration to propagate the vehicle state vector, provided that any component of the sensed acceleration is larger than a predefined minimum threshold, as described later. During dynamic phases of flight when the shuttle is subjected to significant aerodynamic or thrust forces, the IMU accelerations are used. However, during orbit or high-altitude coast, there is concern that the state vector would be “polluted” by using small IMU-sensed accelerations that are due to vibration or low-level IMU errors, such as accelerometer biases; therefore, the GPCs are programmed to ignore the IMU acceleration data that are below the threshold. Instead, whenever the IMU-sensed acceleration is below the minimum threshold, the GPCs use an atmospheric drag acceleration model for state vector propagation. The drag model is described later in this section.

In addition to accelerometer data, the IMUs provide data from which the orbiter attitude is determined. The GPCs derive the orbiter attitude from resolver-measured gimbal angles relative to the IMU platform, as shown in Figure 2-2. The IMU platforms tend to slowly drift from their known inertial orientations (the typical drift rate per axis is approximately 0.006 deg/hour); the resulting misalignment causes errors in the derived orbiter attitude. Platform misalignment also results in errors in the IMU-sensed acceleration, thereby potentially degrading the propagated state vector. Consequently, the IMU platforms are periodically realigned (approximately every 24 hours) during orbit to correct for platform drift (see the IMU 2102 Workbook).

Equations of Motion; Super-G Navigation

The GPC computation of the shuttle state vector from the IMU-sensed acceleration data is performed using classical equations of motion in combination with an Earth gravitational model (and an atmospheric drag model when IMU data are ignored) by a software function referred to as Super-G Navigation. The GPCs cyclically recompute the shuttle state vector once every 3.84 seconds; this period is referred to as a Nav Cycle.

Note: The DPS Input/Output (I/O) sequencing rate is based upon a Major Cycle, which is 960 milliseconds. A Nav Cycle spans four major cycles.

The name “Super-G” comes from the technique of initially estimating the state vector position in order to estimate the change in gravity over time, and then using this to recompute a new, more accurate state vector position. It was designed to be simple and computationally fast, yet retain adequate accuracy to accomplish mission goals.

A fundamental, simplifying assumption employed in the equations of motion is that in any time interval Δt , the shuttle undergoes uniform, linear acceleration. Given this assumption, the change in the shuttle’s position due solely to nongravitational, IMU-sensed accelerations can be written as

$$\frac{1}{2} \Delta V_{IMU} \Delta t$$

where ΔV_{IMU} is the change in velocity sensed by the IMUs.

This term may be rewritten in the more familiar form

$$\frac{1}{2} a \Delta t^2$$

where $a \approx \frac{\Delta V_{IMU}}{\Delta t}$ is the average acceleration over the time interval Δt .

In addition, the shuttle undergoes a change in position due solely to gravitational acceleration, written as

$$\frac{1}{2} G \Delta t^2$$

where G is the acceleration due to gravity calculated from the onboard gravity model.

The Super-G algorithm is detailed in Figure 2-3. Given the simplifying assumption of uniform, linear acceleration, an estimate of the new shuttle position R based on its previous position R_1 and velocity V_1 , can be written as in block 3 in Figure 2-3. The new shuttle velocity V_2 is similarly computed from the previous velocity V_1 , ΔV_{IMU} , and the average acceleration due to gravity over Δt , as shown in block 5. Finally, the new state vector position R_2 is computed from the initial estimate of position R and a higher order correction factor to account for gravitational changes over the time interval Δt , as shown in block 6.

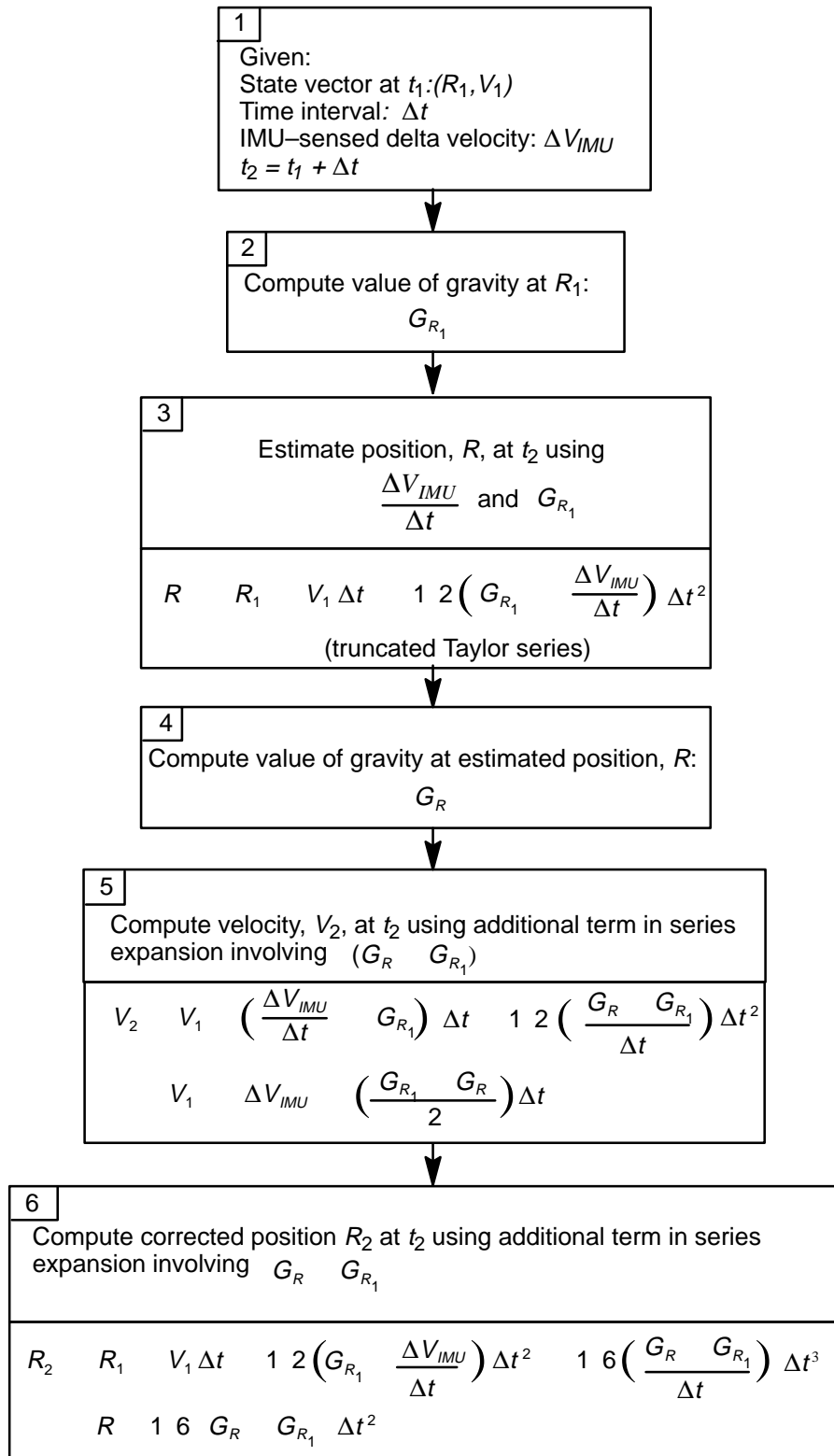

Figure 2-3. Super-G algorithm using IMU-sensed acceleration

Modeled Forces

Gravity Model

An IMU accelerometer cannot sense accelerations due to gravity because the force of gravity that acts directly on the vehicle also acts directly on the accelerometer. The gravitational acceleration of the vehicle is equal to the gravitational acceleration of the accelerometer pendulum (recall Galileo's experiment at the Tower of Pisa); therefore, the force of gravity alone does not displace the accelerometer pendulum relative to the vehicle. Other nongravitational forces, such as thrust, aerodynamic lift, and drag, act directly on the vehicle but not also directly on the accelerometer pendulum. Therefore, these forces do cause the pendulum to displace relative to the vehicle. The amount of displacement is a measure of the acceleration experienced by the vehicle, as previously discussed. In short, the IMU accelerometers are used to sense accelerations due to nongravitational forces. The accelerations caused by the force of gravity are derived from an onboard software gravity model.

Recall from elementary physics that the force of gravity decreases with distance from the Earth by the inverse square law.

That is,

$$F \propto \frac{G M m}{r^2}$$

where

F = Force of gravity

G = Universal gravitational constant

r = Radial distance to object from the center of the Earth

M, m = Masses of Earth, object

As a result, gravity decreases by more than 12 percent over the distance from the Earth's surface to an altitude of 200 n. mi. This variation must be taken into account by the navigation software to have accurate navigation. The inverse square law assumes that the Earth is a perfect sphere. However, the Earth is lumpy; for example, the Earth's radius at the Equator is about 13 n. mi. larger than the Earth's radius at the North and South Poles. One might say the Earth has a beer-belly, or that the Earth is an oblate spheroid. In addition, the Earth has other large-scale gravitational anomalies.

A mathematical description of the nonuniform shape of the Earth's gravitational potential includes a central force term that assumes the Earth is a perfect sphere and a series expansion (spherical harmonics) that accounts for the nonspherical effects. There are three types of expansion terms necessary to describe the Earth's gravitational potential: zonal harmonics, sectorial harmonics, and tesseral harmonics. Following is the equation for the gravitational potential (U).

$$U = \frac{GM}{r} \left\{ 1 - \sum_{n=2}^{\infty} \frac{J_n}{2} F(\text{latitude}) \sum_{m=1}^n \frac{G(\text{latitude})}{2m-1} [C_{n,m}(\lambda) H(\text{longitude}) + S_{n,m}(\lambda) I(\text{longitude})] \right\}$$

where J_n are the coefficients of the zonal harmonics; $C_{n,m}$ and $S_{n,m}$ are the coefficients for the tesseral and sectorial harmonics, respectively; and $F()$, $G()$, $H()$, and $I()$ are functions of latitude and/or longitude.

The term GM/r in the above equation corresponds to the central force term as if the Earth were a perfect sphere. Coefficients $J_2, J_3, \dots, J_\infty$ multiply terms dependent only on latitude. The coefficient J_2 corresponds to the Earth's equatorial bulge and has a magnitude on the order of 10^{-3} times the central force term. That is, the equatorial bulge contributes a force that is one thousandth the size of the central force term. All the other terms are on the order of 10^{-6} (or less) smaller than the central force term. The coefficients $C_{n,m}$ and $S_{n,m}$ correspond to the tesseral and sectorial harmonics. These are dependent upon both latitude and longitude.

The orbiter software uses a detailed gravity model sometimes and a simpler gravity model at other times. The detailed gravity model is of degree (n) and order (m) four. That is, it includes J_2, J_3 , and J_4 and the tesseral and sectorial harmonics out to n and m equal to 4. The simpler gravity model takes into account only the central force term and the zonal harmonic J_2 due to the equatorial bulge.

The complicated functions of latitude and longitude for the tesseral and sectorial harmonics require significant computer processing, so the fourth order gravity model is not used during dynamic phases of flight. During Ascent or Entry (OPS 1, 3, 6), the detailed gravity model is used only when the IMU-sensed accelerations are below a threshold. During powered flight Ascent and at other times in OPS 1, 3, 6 when significant forces are acting on the vehicle, a simpler gravity model is used. In this manner, during the most dynamics phases of flight, the higher order gravity terms are neglected to save software processing time. Once on orbit in OPS 2 and 8, the detailed gravity model is used no matter how large the IMU-sensed accelerations are.

Drag Acceleration Model

Another force on the vehicle is atmospheric drag. The amount of drag on the vehicle varies greatly during the Ascent and Entry phases and is small, though not negligible, on orbit. Drag causes the shuttle's orbit to decay; the decay rate is a function of vehicle velocity, attitude, atmospheric density, and the vehicle's aerodynamic surface area. For example, at an orbit altitude of 160 n. mi., under standard atmospheric conditions, the orbit altitude decreases by 0.5 n. mi. to 1.0 n. mi. per day, depending upon the vehicle attitude.

The IMU accelerometers are used to measure drag acceleration on the vehicle; however, IMU data are used for state vector propagation only if they exceed a threshold. In cases in which IMU data are not used by navigation, a model of the vehicle's acceleration due to drag is used. This process is depicted in Figure 2-4. The drag acceleration model computes drag based upon the vehicle's navigation-derived altitude (from which atmospheric density can be estimated from a model of the Earth's atmosphere), angle of attack, sideslip angle, and reference area. The

atmospheric model also takes into account the diurnal atmospheric density variation and the seasonal effects of density at various latitudes.

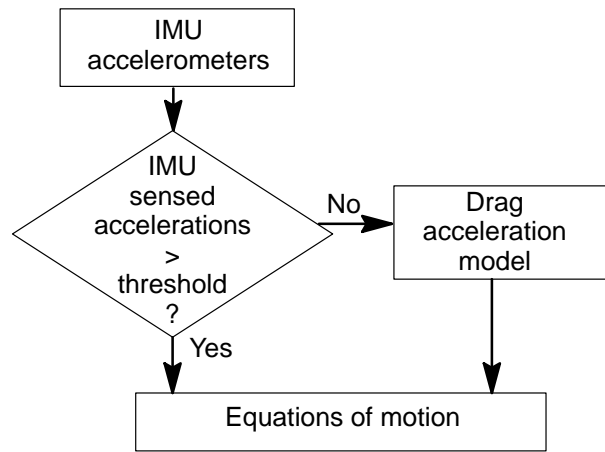

td212_012

Figure 2-4. IMU-sensed acceleration versus drag acceleration model

In OPS 2 and OPS 8, MCC can uplink a correction factor called a KFACTOR that multiplies the computed drag coefficient for the orbiter. In this way, if ground tracking shows that the actual drag acting on the vehicle is larger or smaller than what the software is using, the correction factor increases or decreases the drag accelerations going into the equations of motion. This capability would be used in cases where, for example, a large payload is attached to the orbiter that significantly changes the vehicle's reference area. The capability also allows adjustments due to deviations of the actual atmospheric density from the atmospheric density model loaded in the GPCs.

In OPS 1, 3, and 6, IMU-sensed drag acceleration is used when the sensed acceleration exceeds a threshold level. When IMU-sensed acceleration does not exceed the threshold, such as in coasting flight, modeled drag is used. During Ascent until after the MPS dump, this threshold is set to zero. After this, it is set to 1000 μg until 15 seconds before any Orbital Maneuvering System (OMS) burn during which it is set to zero. During coasting flight, there is concern that the state vector would be polluted by using small IMU-sensed accelerations due to the known low-level errors in the IMUs (particularly accelerometer biases). Also, the Nav base on which the IMUs are strapped is located 55 feet forward of the orbiter center of gravity (c.g.). This results in small erroneous translations being sensed when a pure rotation about the orbiter c.g. is made. The threshold is set at a level which should prevent these erroneous translations and the low-level IMU errors from polluting the state vector.

During OPS 2 and 8, a more complex system is used to provide the more accurate navigation required for the extended periods during orbit and to account for the smaller sensed accelerations that result from vernier jet firing. This includes a correction in the software to convert the IMU accelerations that use the navigation base as a reference to accelerations that use the orbiter c.g. as a reference. This eliminates the errors caused by the c.g. to Nav-base lever arm effects. This computation is made based upon the current orbiter angular rates as estimated by the orbit Digital Autopilot (DAP).

While in MM 201, the crew has the capability to inhibit navigation from using IMU-sensed acceleration via the “AVG G” item located on the REL NAV display (Figure 2–5). The AVG G item is also located on the Flight Control System/Dedicated Display Checkout (FCS/DED DIS C/O) display, which is available during OPS 8. When AVG G is disabled, the orbiter is in a coasting flight navigation mode. In this mode, which to date has never been used in flight, only modeled drag acceleration is used.

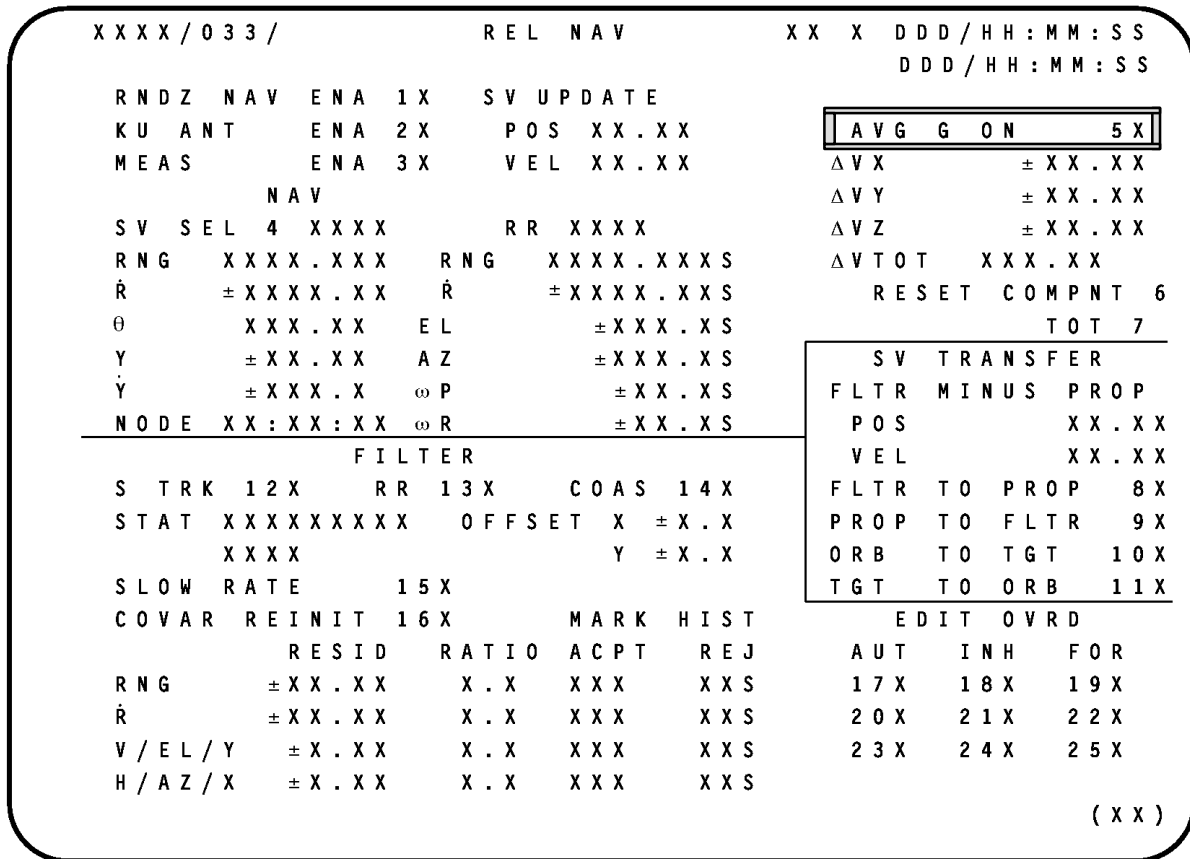

td212a_013

Figure 2–5. REL NAV display – AVG G item

When AVG G is enabled, as it typically is, the orbiter is in its dynamic flight navigation mode. In this mode, IMU-sensed acceleration is used based upon the threshold tests. Note that AVG G is initialized to the enabled state on the transition to OPS 801 or 201. In MM 202, AVG G is always enabled. The threshold tests used by dynamic flight navigation software in OPS 2 and 8 include the following:

- a. A test for an OMS burn in progress and for nonpropulsive thrusting. In this test, if the sensed acceleration over the last Nav cycle (corrected to the orbiter c.g.) exceeds a predetermined value, it is incorporated in the state vector. This threshold value is initialized to 1000 μg . The crew can view and/or modify this threshold in OPS 2 via the ΔV THRESHOLD item on SPEC 21, the IMU ALIGN display (Figure 2–6), although to date it has never been changed. Note that the displayed value on this display is in terms of acceleration multiplied by time. Since the Nav cycle is 3.84 seconds, 1000 μg appears on the display as 3840.

```

XXXX / 021 /          IMU ALIGN          XX X DDD / HH : MM : SS
IMU                  DDD / HH : MM : SS

      1 S      2 S      3 S
STAT  XXXX  XXXX  XXXX
TEMP   XX   XX   XX   IMU  1  10X  STAR ALIGN  13X
STBY   21X  22X  23X   2  11X  14 IMU / IMU   X
OPER   4X   5X   6X   3  12X  MATRIX          15X
DES    7X   8X   9X

                                EXEC  16X
                                TERM  17

ACC
      1      2      3
X  ±X.XX ±X.XX ±X.XX
Y  ±X.XX ±X.XX ±X.XX
Z  ±X.XX ±X.XX ±X.XX

IMU BITE MASK
  1  XXXX  24X
  2  XXXX  25X
  3  XXXX  26X

ANG
      1      2      3
X  XXX.XX XXX.XX XXX.XX
Y  XXX.XX XXX.XX XXX.XX
Z  XXX.XX XXX.XX XXX.XX
ΔX ±XXX.XX ±XXX.XX ±XXX.XX
ΔY ±XXX.XX ±XXX.XX ±XXX.XX
ΔZ ±XXX.XX ±XXX.XX ±XXX.XX

NAV ΔV THRESH
  18 XXXXXX

MM READ  19X

( X X )

```

td212a_015

Figure 2-6. IMU ALIGN display – NAV ΔV threshold

- b. Test for translations resulting from Reaction Control System (RCS) jet firings. In this test, if RCS jet firings occur, the IMU-sensed acceleration is used to propagate the state vector if the value of the acceleration accumulated over the jet firing interval exceeds a threshold. This threshold is currently set at 0.09 ft/s. By comparing the IMU-sensed acceleration accumulated over the jet firing interval to a threshold, low-level translations that would not exceed the 1000-μg test threshold can be detected. Unfortunately, the 0.09-ft/s threshold is too large to detect vernier RCS jet uncoupled thrusting; uncoupled thrusting refers to the situation in which a commanded rotation results in both a rotation and a small translation due to the placement of the jets.

If AVG G is enabled but the sensed IMU accelerations do not pass either of the two threshold tests, modeled drag is used in state vector propagation.

Vent Force Model

The capability exists in OPS 2 and OPS 8 for MCC to uplink vent force accelerations to the onboard equations of motion. This is appropriate, for example, for long periods of maintaining a given attitude using the vernier jets. The vernier jets do not produce pure rotations because they are not aligned with the body axes. Thus, vernier jet firings cause small translational accelerations to be imparted to the vehicle. The magnitude of these translational accelerations is below

the IMU acceleration threshold, so they are not used to update the state vector. This results in a slowly degrading state vector.

If a vent is expected, MCC has the capability to uplink a magnitude, direction, start time, and stop time for the vent for input to the vent model. The resulting acceleration is then used to update the state vector. To turn off the modeled vent force before the original stop time, MCC can uplink a new stop command. If uplink is not available, the crew can turn off the modeled vent by transitioning the GPCs from GNC OPS 2 to GNC OPS 8 and back to OPS 2, since the vent model calculation does not carry over an OPS transition.

State Vector Schemes

There are two separate schemes by which the GPC software arrives at a single state vector for navigational use, given that redundant acceleration data are available from three IMUs. In OPS 3 Entry only, three independent state vectors are propagated by Super-G Nav, from which a single state vector is selected; this is referred to as the three state vector scheme. In all other phases of flight, a process referred to as the single state vector scheme is used. These schemes are discussed in the following topics.

Single State Vector Scheme

The single state vector scheme, shown in Figure 2–7, is used in the Ascent, Orbit, Rendezvous (RNDZ), Pre-land, and RTL phases of shuttle flight; in other words, all phases except for the OPS 3 Entry phase. The BFS uses this scheme for all phases.

The IMU-sensed total velocity components from each IMU are fed into a Redundancy Management (RM) selection filter. Recall from the discussion of IMU that “total velocity” is a measure of the IMU-sensed acceleration. The output of the selection filter is a single set of total velocity components (ΔV_x , ΔV_y , ΔV_z), which are input into the Super-G Nav equations of motion, in conjunction with the gravity and drag models, to produce a single state vector.

The RM of the selection filter works as follows. If three IMUs are available, the selection filter will Mid-Value Select (MVS) from the total velocities, component by component. In other words, given the three X-direction, three Y-direction, and three Z-direction components of the total velocities, the median value of each component is selected. If two IMUs are available, the selection filter averages the total velocity components. If only one IMU is available, then its total velocity components are selected. More information on IMU RM is found in the IMU 2102 Workbook.

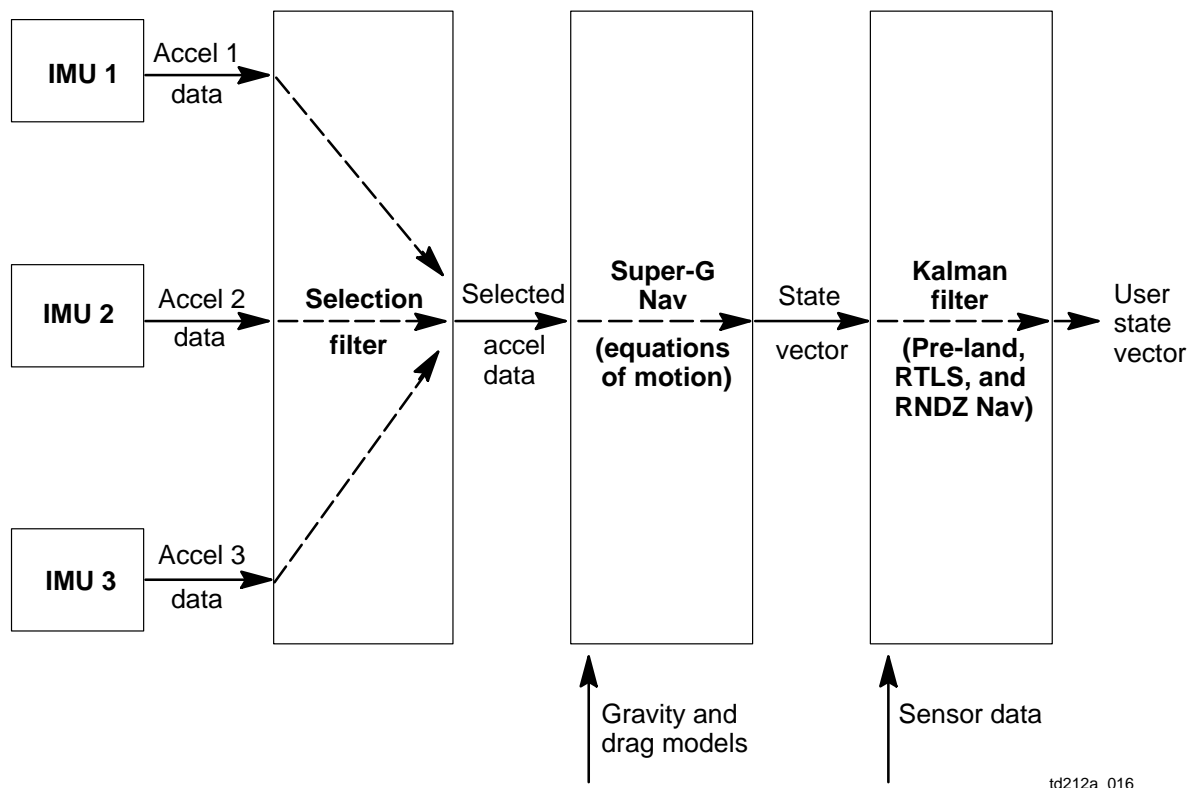

td212a_016

Figure 2–7. Single state vector scheme

In Pre–land, RTLS, and RNDZ phases of flight, the single state vector calculated by Super–G Nav is input to a Kalman filter (also known simply as the Nav filter). The function of the Kalman filter is to incorporate external Navigation–aid (Nav aid) sensors into the Super–G Nav state vector to improve its accuracy. In Pre–land Nav, data from the Microwave Landing System (MLS) sensors are incorporated. In RTLS Nav, data from the Tactical Air Navigation System (TACANS) and Air Data System (ADS) sensors are incorporated, as well as a model–based calculation of shuttle altitude from sensed atmospheric drag (drag H). In orbit RNDZ Nav, data from the Star Tracker, COAS, and Rendezvous Radar (RR) sensors may be incorporated. Each of these sensors is discussed in Section 3.

The external sensor data are needed to improve the Super–G Nav state vector in navigationally critical phases of flight because the Super–G algorithm and the IMU data it uses are not perfect; as a result, the Super–G state vector tends to diverge from the actual state vector (where the orbiter actually is) over time. The Kalman filter’s task is to determine how much each sensor measurement will be used to “correct” the Super–G Nav state vector to meet mission requirements for those critical phases. Optimally, the output of the Kalman filter is the most accurate shuttle state vector that the onboard software can generate. Kalman filtering is discussed in more detail in Section 3.

The final state vector output from the Kalman filter is referred to as the User state vector. The User state vector is used for shuttle navigation, guidance, and control. In Ascent and non–RNDZ orbit phases, external sensors are not incorporated (the Kalman filter is not active); hence, the User state vector is simply the Super–G Nav state vector.

A primary user of the User state vector is the shuttle Guidance and Control (G&C) software. Navigation software requires too much time between User state vector calculations (one Nav cycle = 3.84 sec) for guidance to maintain smooth flight control during dynamic flight. Therefore a guidance software module, called User Parameter Processing (UPP), is used to integrate the equations of motion over shorter intervals of time (0.16 sec). UPP takes the most recent User state vector, the last computed value for gravity, and either IMU-sensed acceleration (if above the threshold) or modeled drag acceleration and quickly computes an updated state vector using the “Average G” technique. In this technique, if s_0 is the initial position, v_0 the initial velocity, a_0 the IMU or modeled drag acceleration, g_0 the value of gravitational acceleration, and Δt the time interval, the new position, s_1 , is computed as

$$s_1 = s_0 + v_0 \Delta t + 1/2 (a_0 + g_0) \Delta t^2$$

The value of gravity, g_1 , at position s_1 is computed and the average of g_0 and g_1 is used to compute the velocity, v_1 , at position s_1 :

$$v_1 = v_0 + a_0 \Delta t + 1/2 (g_0 + g_1) \Delta t$$

In this manner, UPP propagates a state vector between Nav cycles for G&C software that needs the state vector at a much higher frequency than navigation software can supply. At the beginning of each Nav cycle, UPP reinitializes to the Nav state vector and propagates it using the simplified Average-G technique until the next Nav cycle.

Other users of the User state vector include various CRT displays, meters, and tapes that assist the crew in flying the vehicle. In addition, the User state vector is downlinked for comparison with the MCC estimate of the shuttle’s position and velocity.

Three State Vector Scheme

The three state vector scheme, shown in Figure 2-8, is used only by PASS while in the OPS 3 Entry phase of flight. This phase extends from orbit altitude to the Pre-land altitude of approximately 18 kft (the altitude at which MLS is first used for navigation, and the software reverts to the single state vector scheme).

In the three state vector scheme, the total velocities from the IMUs are fed separately into Super-G Nav, which subsequently outputs three independent state vectors, one associated with each IMU. The independent state vectors are maintained through a Kalman filter which incorporates the data from Entry Nav aid sensors: drag H, TACANS, and ADS, as each sensor becomes available. The Kalman filter uses the sensor data to improve the accuracy of the Super-G state vectors. The filtered state vectors are fed into an RM Vector Selector, which reduces them into a single User state vector, which is used for shuttle navigation, guidance, and control, as previously described.

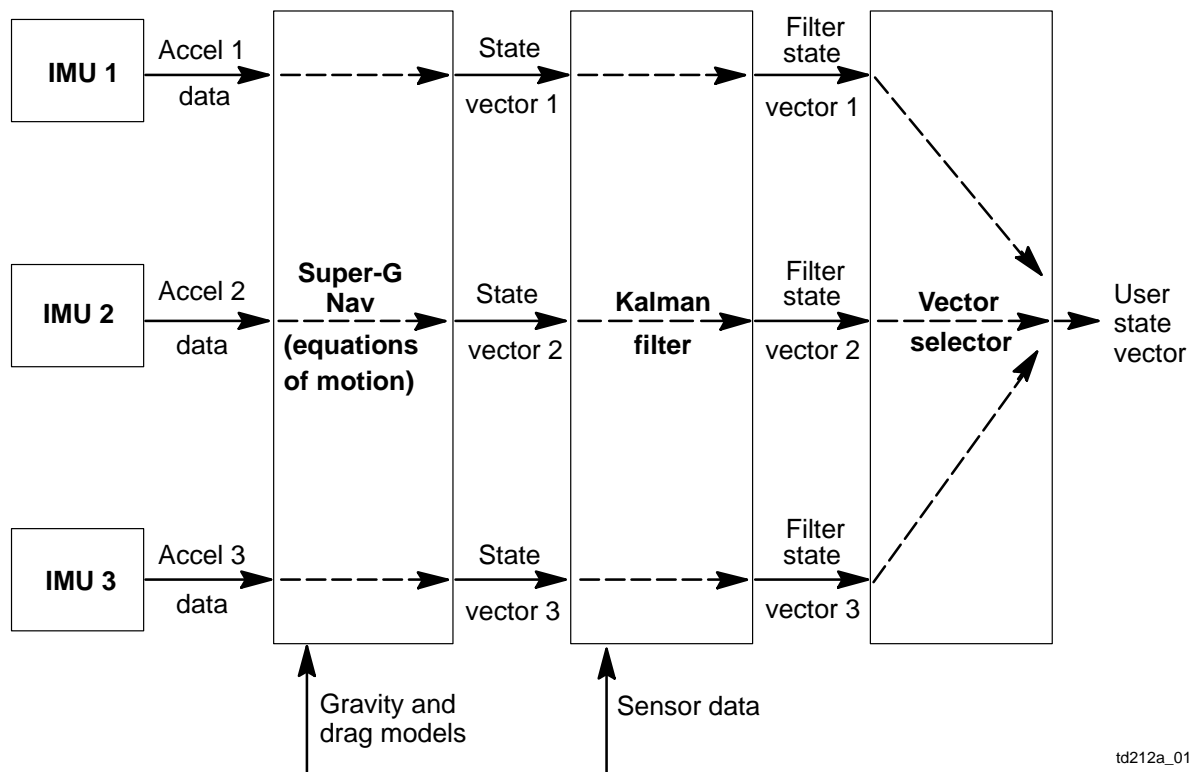

td212a_017

Figure 2–8. Entry three state vector scheme

The RM of the Vector Selector works as follows: if three IMUs are available, the Vector Selector uses the MVS from the three filtered states, component by component, to produce the User state. For example, if $R_{x1} < R_{x3} < R_{x2}$, where R_{x1} , R_{x2} , R_{x3} are the x-components of the position vectors from each of the three state vectors, then R_{x3} is selected as the x-component of the User state vector position. The other components of the User state are similarly selected. If two IMUs are available, the User state is the average of the two available filtered state vectors. If only one IMU is available, then the Vector Selector uses the filtered state associated with the lone IMU.

The three state vector scheme is used for Entry because it provides greater protection for the User state vector than the single state scheme for multiple IMU failures. This is important considering that the margin of error in the User state vector for a successful landing is small (the shuttle has one chance at the runway!).

The advantage of the three state scheme is best illustrated by way of example. Using the three state vector scheme, suppose IMU 3 is failed. Then only state vectors 1 and 2 are available to the Vector Selector, which will average the two to produce the User state. If state vectors 1 and 2 are good, then the User state is good. Now suppose that IMU 2 begins to output biased acceleration data; state vector 2 will now be bad. Vector Selector averages a good state vector 1 and bad state vector 2; therefore, the User state vector is degraded. However, if MCC, the crew, or PASS RM software detects that IMU 2 is faulty, it can be deselected (which makes state vector 2 unavailable to the Vector Selector). If IMU 2 is deselected, then only state vector 1 is available to the Vector Selector. On the next Nav cycle, the User state vector becomes the good state vector 1, and shuttle navigation is quickly fixed.

Now let us apply the same IMU failure scenario to the single state scheme for comparison. With IMU 3 failed, the User state is calculated from the average of IMU 1 and 2 data. If IMU 2 data go bad, the selection filter continues to average the data from IMU 1 and IMU 2, and the User state vector degrades, as in the three state vector case. If IMU 2 is deselected, only good IMU 1 data are available to Super-G Nav. However, unlike the three state scheme, the User state vector remains degraded because, even though Super-G Nav is now being supplied with good acceleration data, the initial conditions are still bad. In other words, in this case, Super-G Nav updates a degraded User state vector with good IMU data, resulting in a still degraded User state vector. To fix the situation, good initial conditions (position and velocity) must be entered into Super-G Nav. This is done via MCC uplink of a good state vector.

This example shows the advantage of the three state scheme over the single state scheme; the three state scheme affords greater protection to shuttle navigation from multiple IMU failures (as few as two). The disadvantage of the three state scheme is that it requires much more software processing than the single state scheme in order to maintain the three independent states. As a result, the three state scheme is not used for all flight phases.

State Vector Prediction Across OPS Transitions

When the PASS GPCs transition from one OPS to another OPS, the applications software temporarily stops processing as new applications software is loaded into the GPCs. Thus, during a GNC OPS transition, navigation software is unable to propagate the state vector. To compensate for this, when the navigation software reinitializes after the OPS transition, it calls a state vector prediction routine.

When a GNC OPS transition is initiated by the crew, the state vector is frozen at the value it had during the last Nav cycle before the applications software stopped processing. State vector prediction uses equations of orbital mechanics to calculate the state vector at some final time (the time tag of the first Nav cycle of the new OPS), given the state vector at some initial time (the time tag of the last Nav cycle of the old OPS). At the end of the OPS transition, the age of the initial time tag is checked. If the initial state vector is less than 10 minutes old, then the new state vector is predicted forward to the current time and then propagated as normal.

If the initial state vector is greater than 10 minutes old, then the prediction software substitutes a default M50 state vector for the orbiter state vector. This default state vector is for a 200-n. mi. equatorial orbit. Therefore, navigation will be bad, but by substituting a default state vector, the OPS transition is allowed to successfully complete and a valid state vector can be uplinked later. Note that the most likely occurrence of this scenario is if the GNC redundant set is stuck in OPS 0 (for longer than 10 minutes) due to a failure during an OPS transition.

Questions

Answers to the following questions can be found in Appendix B.

1. Describe the purpose of the IMU accelerometers.
2. Identify the purpose of the Super-G Navigation software. What are the inputs to Super-G Nav?
3. Explain why navigation software requires the use of a gravity model for state vector propagation.
4. Under what conditions is the detailed gravity model used by navigation software versus the simplified gravity model?
5. When does navigation software use modeled atmospheric drag versus IMU-sensed drag for state vector propagation?
6. Briefly describe how the single state vector scheme works and in what phases of flight it is used.
7. Briefly describe how the three state vector scheme works and in what phases of flight it is used.
8. How often does the onboard navigation software calculate a new User state vector?
9. Describe the type of failure scenario the three state vector scheme is designed to protect for.

Section 3

State Vector Filtering

Objectives

Upon completion of this section, you should be able to

- List the parameters that are provided by the various external sensors for use in Kalman filtering
- Match each external sensor with the phase(s) of flight in which it is used for Kalman filtering
- Define the terms “Residual” and “Ratio”
- Describe Kalman filter updating of the orbiter state vector
- Conceptually describe the covariance matrix and its effect on filter updating
- Define sensor weight and its effect on filter updating
- State the meanings of the filter controls AUTO, INHIBIT, and FORCE

Overview

Section 2 described Super-G Nav and its use of IMU and model data to calculate the state vector. Section 2 also introduced the external sensors that are used to improve the accuracy of the state vector through Kalman filtering. Section 3 describes Kalman filtering in more detail, beginning with a short description of the parameters provided to the Kalman filter from each of the Nav aid sensors. Note the references made to other workbooks that provide more details on each of the sensors.

Entry, RTLS, and Pre-Land Navigation Aids

Drag Altitude (Drag H)

During what used to be the “blackout” phase of Entry (265–180 kft altitude, where uplink or downlink to the orbiter was unavailable because of the ionization of the atmosphere caused by extreme heating), potentially the propagated state vector could begin to diverge from the true state vector. Note that most shuttle missions no longer experience blackout because data are sent from the orbiter up to the Tracking and Data Relay Satellite (TDRS) behind and above the orbiter. To limit the rate of state vector divergence, navigation uses a model-based calculation of orbiter altitude for input to the Kalman filter. This computation of altitude is called “drag altitude,” or simply drag H.

The drag H calculation is a two-step process, as shown in Figure 3–1. First, using IMU-sensed drag acceleration, the software calculates the atmospheric air density. Then, given the air density, the software infers an orbiter altitude from a standard atmosphere model of altitude versus air density. The derived orbiter altitude is input to the Kalman filter. Although drag

altitude is based upon an onboard model calculation, it is processed by the Kalman filter as external sensor data.

The atmospheric air density ρ can be expressed in terms of known and measured quantities as:

$$\rho = \frac{\text{Drag}}{\left(\frac{1}{2}V^2S\right) C_d}$$

Where: $Drag$ is the acceleration sensed by the IMUs.
 V is the orbiter velocity from the state vector.
 S is the reference surface area of the orbiter.
 C_d is the orbiter drag coefficient, which is a function of the angle of attack: the angle between the orbiter's attitude (from the IMUs) and the velocity vector (from the state vector).

Using the calculated air density and a standard atmosphere model of air density versus altitude, find altitude.

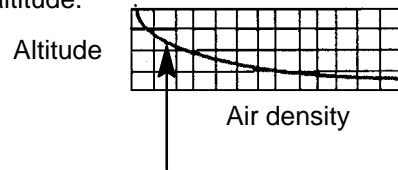

Given density, look up altitude.

td212A_018

Figure 3-1. Drag H calculation

The accuracy of drag H is dependent upon the accuracy of the IMU acceleration data and the atmospheric model. However, drag H is not meant to be extremely accurate. Its purpose is to limit the growth of the errors in the state vector. Without drag H, it is possible for the errors in the state vector to grow exponentially.

Drag altitude begins to be used by navigation during Entry when the sensed drag acceleration reaches 11 ft/sec^2 (± 240 kft altitude for nominal end of mission) and is used until air data are used by navigation or altitude is less than 85,200 ft (if air data is unavailable). The crew procedures concerning drag H for a normal Entry are provided in Section 5.

Tactical Air Navigation System

Each of the three onboard Tactical Air Navigation (TACAN) units provides orbiter slant range and bearing with respect to the TACAN ground station (Figure 3-2). The RM-selected range and bearing data are input into the Kalman filter. More details on the TACANS can be found in the NAV AIDS 2102 Workbook.

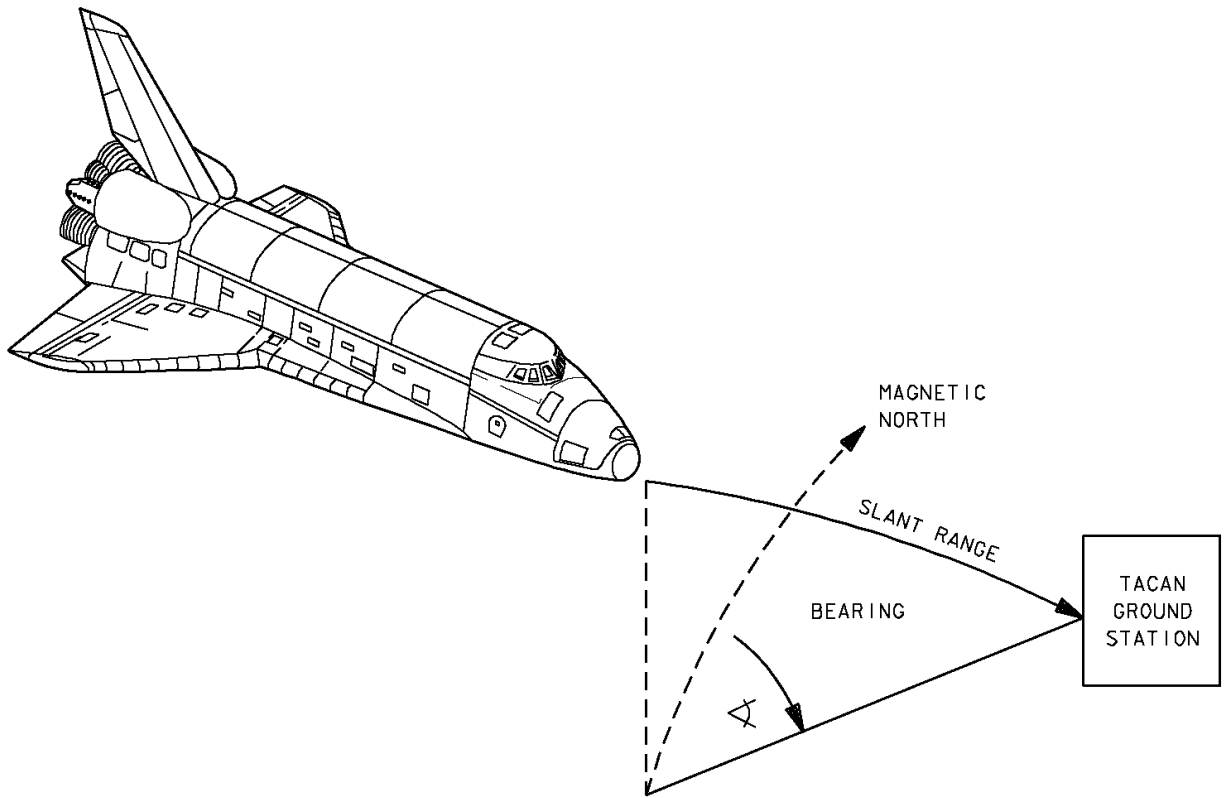

TD212A019. ART, 1
td212a_019

Figure 3-2. TACAN slant range and bearing

Each of the onboard TACAN units determines slant range by emitting signals that are received by the TACAN ground station, where they are turned around and sent back up to the onboard TACAN unit. The onboard unit measures the round-trip time of the signal. By multiplying speed of light by the signal travel time, the TACAN unit measures the slant range.

The onboard TACAN units determine bearing angle by listening to signals from the TACAN ground stations. The ground stations have two antennas which provide bearing angle. One antenna is a directional antenna that rotates at a fixed rate. The other antenna is an omnidirectional antenna that can send a pulse out in all directions simultaneously. When the directional antenna is pointing due north, it sends out a pulse called the “main reference pulse.” The orbiter’s TACAN units receive this main reference pulse, and they start timers. When the directional antenna is pointing at the orbiter, then the onboard TACAN units stop their timers. Since the directional antenna rotates at a fixed rate, this time delta is a measurement of the bearing angle.

For a nominal Entry, TACAN bearing and range data are used by navigation software beginning at approximately 140 kft altitude until approximately 18 kft altitude when MLS data are acquired. However, the software inhibits the use of TACAN bearing data for state vector filtering while the orbiter is in the TACAN ground station “cone of confusion.”

The cone of confusion is a region of space directly above the TACAN ground station, where there is a weak signal for bearing. This region has the shape of an inverted cone whose included

angle is 110° (shown in Figure 3–3). The navigation software determines that the orbiter is in the cone of confusion by simply calculating elevation angle between the TACAN ground station and the orbiter's state vector position.

The crew procedures for the nominal use of TACAN data are provided in Section 5.

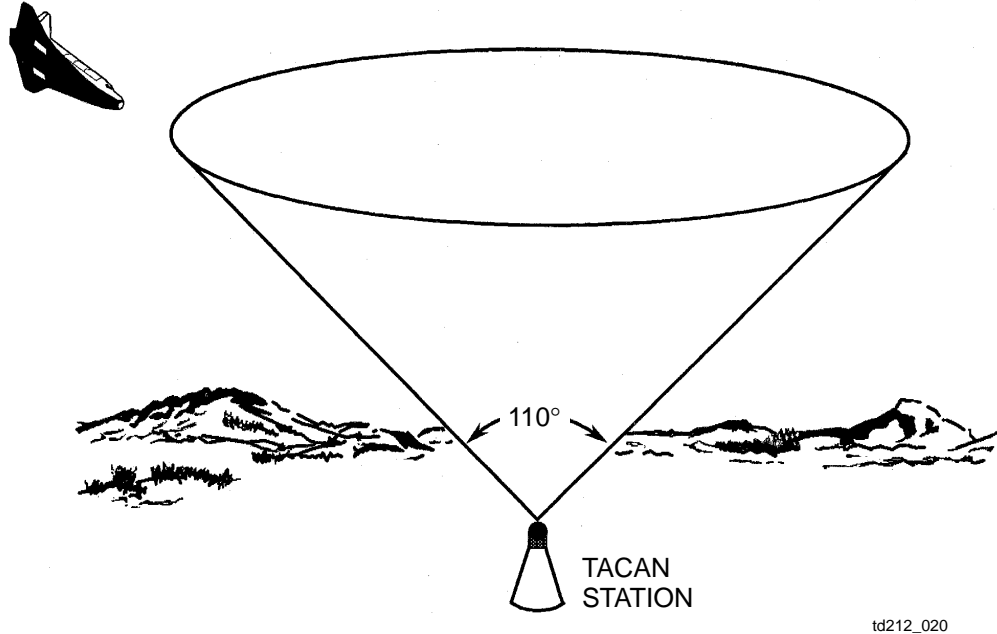

Figure 3–3. TACAN cone of confusion

Air Data System

The ADS is composed of two air data probes, left and right, with two Air Data Transducer Assemblies (ADTAs) associated with each probe. The ADS is used to sense air pressures that relate to orbiter movement through the atmosphere. These are used to compute angle of attack (Δ), Mach number (M), Equivalent Air Speed (EAS), True Air Speed (TAS), dynamic pressure (\bar{q}), barometric altitude (h), and altitude rate. The RM–selected barometric altitude is the only parameter used in navigation software. The other parameters are used by guidance and flight control and displayed to the crew on the CRT and dedicated displays. Details on the ADS are found in the ADS 2102 Workbook.

Air data altitude is normally used for navigation from Mach 2.5 until MLS data are acquired. However, between Mach 1.6 and Mach 1.1 (the Mach Jump region), navigation will not use air data. This is because unstable airflow involving secondary shock waves is expected over the air data probes as the vehicle starts to go subsonic. The crew procedures for the nominal use of air data are provided in Section 5.

Microwave Landing System

There are three onboard MLS units that determine the orbiter slant range, azimuth angle, and elevation angle from the runway. These parameters are defined in Figure 3–4. MLS is available in PASS software only and is not available at all the runways. A detailed description of MLS is found in the NAV AIDS 2102 Workbook.

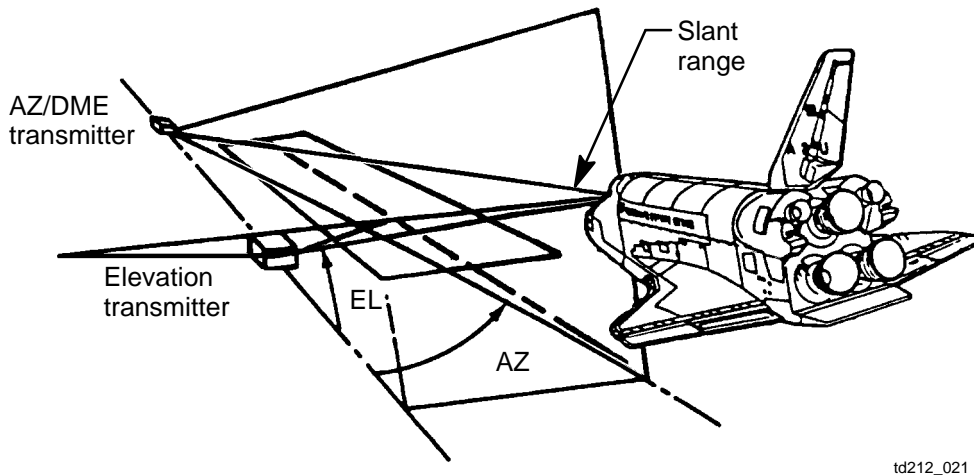

td212_021

Figure 3-4. MLS slant range, azimuth, and elevation

MLS data normally become available when the vehicle is at approximately 18 kft altitude. The data are used through landing. Since MLS is so much more accurate than air data or TACAN data, once MLS becomes available, air data and TACAN data are no longer incorporated into the state vector. The crew monitors the incorporation of the RM-selected MLS data into the state vector on SPEC 50; this procedure is described in Section 5.

The MLS slant range is measured in a similar manner as slant range for the TACANS. That is, each onboard MLS unit sends out a signal which is received by the ground station Distance Measurement Equipment (DME) and sent back up to the orbiter. The onboard MLS units can then determine the slant range from the signal travel time.

The elevation angle is produced by an antenna on the ground station that scans up and down. This is why MLS is also referred to as MSBLS, which stands for Microwave Scanning Beam Landing System. As the elevation antenna on the ground scans upward, it sends out a different signal depending on its pointing angle. The antenna scans upward to a maximum of 29° and then scans back down. The onboard MLS units decode the signal and output the elevation angle for use by navigation.

The azimuth angle is the angle to the right or left of the runway centerline and is measured in a similar manner as the elevation angle. The azimuth antenna on the ground scans back and forth, and the onboard MLS units receive the signal and output the azimuth angle for use by navigation.

Rendezvous Navigation Aids

Star Tracker

The orbiter Star Tracker is an electro-optical tracking device that is used to obtain precise angular measurements of selected stars and Sun-illuminated orbiting objects (targets). The star measurements are used to determine the orbiter's attitude in inertial space, and these data are used to align the IMU platforms. For rendezvous operations, the Star Tracker provides the relative angular Line of Sight (LOS) between a target and the orbiter. The LOS angles are used to improve the orbiter state vector through Kalman filtering.

Two Star Trackers, -Y and -Z, are located next to the IMUs on a beam attached to the orbiter's navigation base (see Figure 3-5). They are slightly inclined off the vehicle axes for which they are named. The -Y Star Tracker centerline is approximately 10.5° from the orbiter -Y axis, and the -Z Star Tracker centerline is approximately 3° from the orbiter -Z axis. Details on the Star Trackers and their operations are found in the Star Tracker/COAS 2102 Workbook.

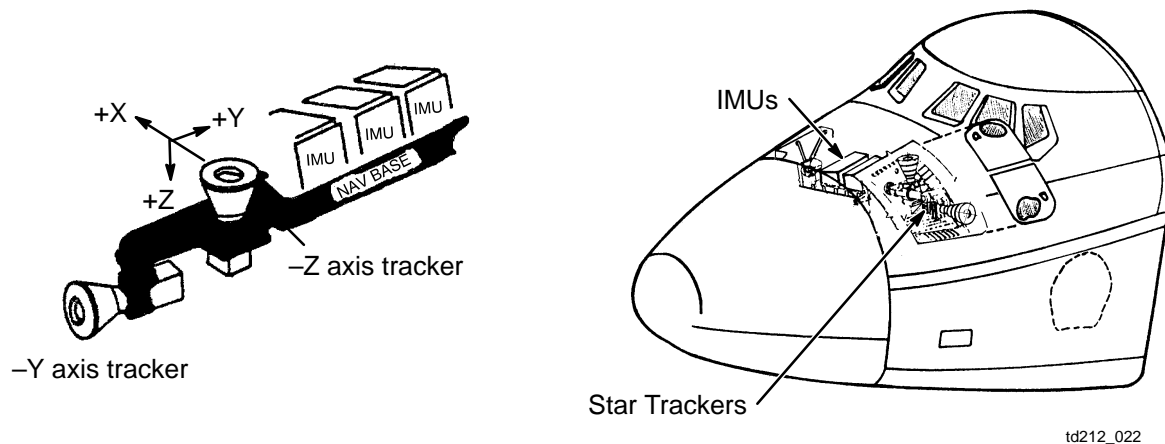
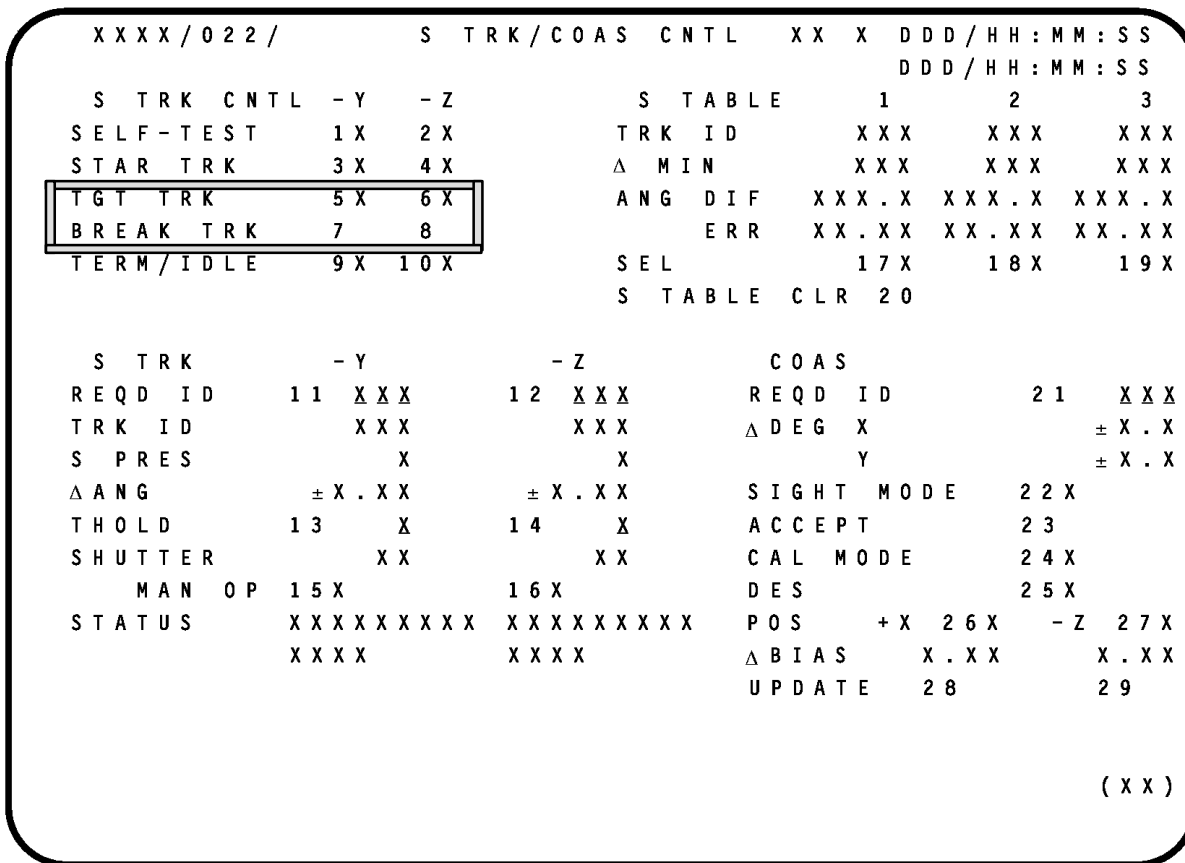

Figure 3-5. Star Tracker location

The Star Trackers are controlled onboard, using the S TRK/COAS CNTL display, SPEC 22 (Figure 3-6). For RNDZ navigation, a Star Tracker locates an illuminated target in its Field of View (FOV), tracks the target, and provides accurate horizontal and vertical angle information to navigation. This operation is called the target track mode (TGT TRK on SPEC 22) of the Star Tracker.



td212a_023

Figure 3-6. S TRK/COAS CNTL display – target track and break track

Before commanding the selected Star Tracker to begin tracking a target, the orbiter is positioned so that the selected Star Tracker is pointed toward the target. This is done by the crew while in GNC Major Mode 201 (MM 201), using the Universal Pointing display (UNIV PTG). Once maneuvered to the target, the target track item can be selected on the SPEC 22, at which time the Star Tracker searches for the target and tracks it if found. The target continues to be tracked until the target leaves the FOV or until the crew commands the Star Tracker to stop tracking (BREAK TRK) via SPEC 22.

As described in Section 5, the Star Tracker data received while tracking a target are used by navigation if Rendezvous navigation is enabled (Item 1 on the REL NAV display, SPEC 33); if the Star Tracker is selected as the external sensor to be used to provide target angle data (Item 12 on the REL NAV display); and if the Star Tracker data passes a Nav filter test. The data provided by the Star Tracker are the horizontal and vertical angles to the target.

Crew Optical Alignment Sight

The COAS is an optical device that is used to manually sight stars or a target. The COAS essentially consists of a tube with an adjustable light that shines through the tube, illuminating a reticle (cross-hair) pattern. The reticle pattern is reflected off a glass through which a crewmember can view bright objects. In this way, the crewmember can look through the glass at a star or target and identify when the star or target passes through the center of the reticle. When

marking on stars, the COAS can be used as a backup to the Star Trackers to align the IMUs. However, the HUD is the primary backup to the Star Trackers for IMU star alignments. Details on the COAS and operations are found in the Star Tracker/COAS 2102 Workbook.

As described in Section 5, for Rendezvous navigation, the COAS can be used to take marks on the target to provide horizontal and vertical angles to the target for incorporation into navigation. The COAS is used for this purpose in the off-nominal case that both Star Trackers are unavailable. Nominally, the COAS would be used to verify that the target is in the same place in the COAS FOV that the Star Tracker data indicate. In addition, the COAS is used for RNDZ or Proximity Operations (Prox Ops) manual flying to provide cues to the commander on the motion of the orbiter relative to the target. The commander can then translate the orbiter to keep the target in the appropriate location in the COAS.

The COAS may be mounted in two locations defined by the vehicle axis along which it sights, as shown in Figure 3-7. The forward location, or +X, is above the commander's window. The aft location, or -Z, is next to the starboard overhead window.

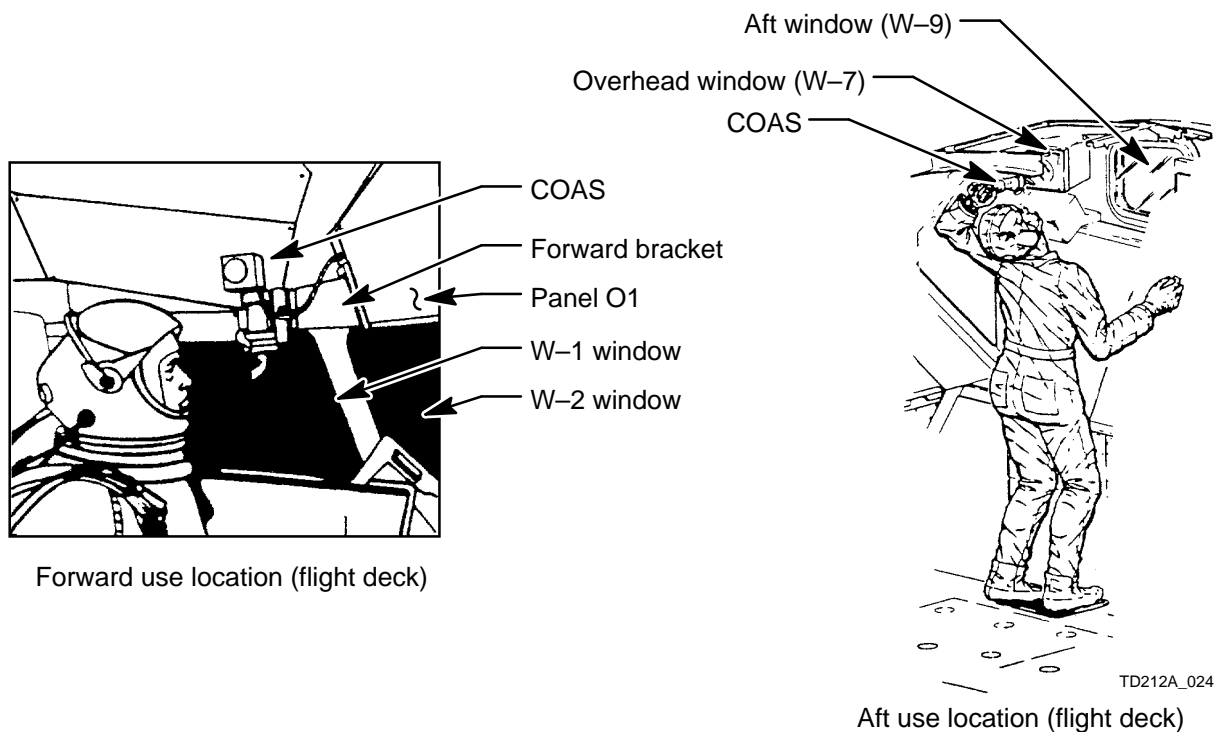

Figure 3-7. COAS locations

Rendezvous Radar

The RR provides automatic target detection, acquisition, and tracking. It assists in reducing target location uncertainties during rendezvous maneuvers. The radar tracks a target automatically to determine range, range rate, azimuth angle, and elevation angle relative to the orbiter.

The RR operates as part of the Ku-band system. The Ku-band system is a dual purpose system that can be used as a wideband communications system for data exchange with the ground through TDRS, or as RR. The functions of Ku-band communication and radar are not available simultaneously.

During rendezvous operations, the RR data are input into Rendezvous navigation through the Kalman filter. Once RR is available and considered to be valid (by flight rule, it is not valid outside of 135 kft because of problems with the range data), the crew inhibits the other sensors (Star Tracker or COAS) from use for navigation, and the RR data are used to improve the state vector.

Kalman Filtering

Kalman filtering is a software function that incorporates the external sensor data into the propagated state vector to provide a more accurate estimate of the vehicle position and velocity. The Super-G Nav state vector is input to the Kalman filter (see Section 2). The output of the Kalman filter is the filtered state vector. The Kalman filter adds an update factor to each of the six Super-G Nav state vector components (R_x , R_y , R_z , V_x , V_y , and V_z) to form the components of the filtered state vector. Each component of the filtered state vector X_f may then be written as

$$X_f = X + U_K$$

where X is the component of the Super-G Nav state vector, and U_K is the Kalman update factor for that component. The units for U_K are in feet for position coordinate updates and ft/sec for velocity coordinate updates.

The update factors for each component are expressed as the product of two variables: the Kalman gain K for the component and sensor parameter Residual (Resid). These variables are defined later. Hence each component of the filter vector may be written in a form known as the Kalman filter update equation

$$X_f = X + K \quad \text{Resid}$$

The update equation is applied n times per Nav cycle, where n is the number of sensor parameters being incorporated. For example, if drag H and TACAN bearing and range are incorporated ($n = 3$), the state vector is updated by the Kalman filter three times per Nav cycle, once for each parameter. In the three state vector scheme, the update equation is applied to each of three state vectors.

The Residual is calculated by the filter software once per Nav cycle for each sensor parameter available to the filter. The Residual is the difference between the value of the parameter as measured by the sensor and the computed value for the parameter based upon the onboard state vector. For example, the TACAN range Residual is the difference between the measured TACAN range and the TACAN range computed by the navigation software based on the orbiter state vector. This example is illustrated in Figure 3–8. Residuals are similarly calculated by the filter for drag H, TACAN bearing, and baro-altitude (air data) during Entry navigation when each becomes available to the filter. These Residuals are displayed to the crew during Entry on SPEC 50, as described in Section 5. Pre-land and Rendezvous sensor Residuals are similarly calculated. The Residual has the same units as its corresponding parameter; for example, the TACAN range Residual is in units of feet, and TACAN bearing Residual is in units of degrees.

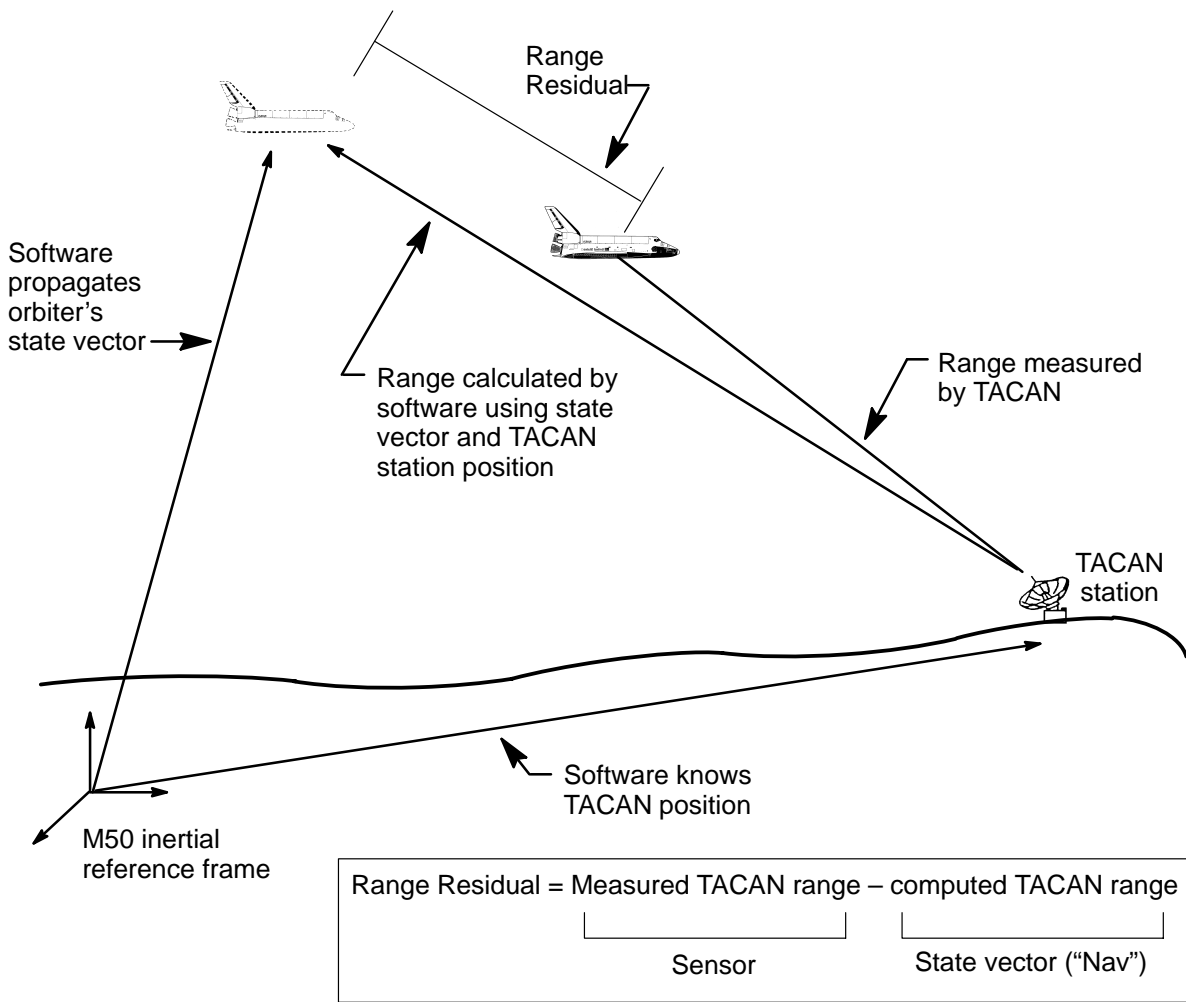

td212a_050

Figure 3-8. Calculation of the TACAN range Residual

The Residual is multiplied by the Kalman gain K . The Kalman gain determines how much and in what direction a Residual will update the state vector. The value of the Kalman gain varies with each sensor parameter and with time. The Kalman gain is a function of the Kalman covariance matrix (cov) and sensor variance (σ_s^2). These are described in the following paragraphs. The Kalman gain can therefore be written as $K = K(\text{cov}, \sigma_s^2)$. It is of the form

$$K(\text{cov}, \sigma_s^2) = \frac{f(\text{cov})}{g(\text{cov}) + \sigma_s^2}$$

where $f(\text{cov})$ and $g(\text{cov})$ are functions of the covariance matrix.

Conceptually, one can think of the covariance matrix as representing a volume in space (position and velocity) that, with a degree of uncertainty, contains the orbiter. Mathematically, the covariance is a 6×6 matrix, whose diagonal elements are the variances (σ^2) of the six state vector components. Recall from statistics that the variance of a measurement σ^2 is the square of the standard deviation σ of the measurement. The standard deviation is defined as follows: for a given measurement, there is a 68 percent probability that the measurement is within 1σ of the actual value (95 percent within 2σ and 99.7 percent within 3σ). One can conceptualize the

first three diagonal elements of the covariance matrix as defining an ellipsoid around the shuttle's estimated position, and the last three diagonal elements as an ellipsoid around the shuttle's estimated velocity. The off-diagonal elements define how errors in one state component affect another (for example, the effect on radial position by downtrack velocity error). These are the cross-correlation, or covariance, terms.

An initial set of values for the covariance matrix diagonal elements σ^2 are I-loaded in the navigation software; in other words, the initial volume of uncertainty about the orbiter state vector is predefined. As sensor data are processed by the Kalman filter, navigation software propagates the covariance matrix with time, updating the matrix elements once per Nav cycle based upon the software's new estimate of the shuttle state vector. Prior to sensor data processing, the covariance matrix is termed as "open"; that is, its elements are at their maximum I-loaded values. As sensor data begin to update the state vector, the covariance matrix "shrinks." This means that the values of the matrix elements decrease as the software estimate of the state vector improves. Conceptually, a shrinking covariance matrix means that the volume of uncertainty in the orbiter state vector is decreasing. After a long period of sensor data processing, the covariance matrix elements shrink to small values.

Generally, when the covariance matrix is open, the filter's uncertainty in the orbiter state vector is large, and the Kalman gain is maximized. As the filter's confidence in the state vector increases over time (that is, the filter's uncertainty decreases), the covariance matrix shrinks. Therefore the Kalman gain also decreases.

As stated before, the Kalman gain is also a function of the sensor variance σ_s . The sensor variances for each parameter are I-loaded constants (except for baro-altitude, which varies with altitude) and have been determined through sensor calibration tests. The smaller the sensor variance, the more accurate is the sensor. Note that σ_s is in the denominator of the expression for Kalman gain. Therefore the smaller the sensor variance, the larger the Kalman gain for that sensor. The inverse of the sensor variance $1/\sigma_s$ is referred to as the sensor "weight." Therefore we say that the more accurate a sensor is, the more weight it is given by the filter in updating the state vector.

Figure 3-9 shows the values of σ_s and σ_s^2 for the Nav aid sensors used during Entry. The units for σ^2 are in ft^2 or radians^2 . Values for baro-altitude vary with altitude h . From Figure 3-9 you can determine the relative importance to state vector updating of the various sensor parameters. For example, the baro-altitude weight is approximately one order of magnitude greater than drag H, thus the rationale for the discontinued use of drag H for state vector updating once baro-altitude is incorporated (drag H updating is simply "in the noise" compared to baro-altitude updating). Similarly, MLS range is weighted approximately three orders of magnitude more than TACAN range; hence once MLS is incorporated, the use of TACAN (and baro-altitude) is discontinued.

Sensor	$1\sigma_s$ value and units	Variance (σ_s^2)
Drag altitude	10 kft	$1 \cdot 10^8$
TACAN range	600 ft	$3.6 \cdot 10^5$
TACAN bearing	5.7°	$1.0 \cdot 10^{-2}$
Barometric altitude	$f(h)$	$f(h) \cdot 10^7$
MLS azimuth	0.18°	$1.0 \cdot 10^{-5}$
MLS elevation	0.18°	$1.0 \cdot 10^{-5}$
MLS range	24 ft	$5.75 \cdot 10^2$

Figure 3-9. Standard deviation σ_s and variance σ_s^2 for the Entry sensor parameters

Figure 3-10 graphically summarizes some of the concepts of the preceding discussion of Kalman filtering. It depicts the effect of sequential sensor measurements to update the Super-G Navigation (IMU-propagated) state vector once per Nav cycle. Each Kalman update adds a correction factor to the propagated state vector. Assuming the sensor data are accurate, the successive Kalman updates tend to help the propagated state vector converge toward the actual state vector. Each successive update becomes smaller for two reasons. First, the sensor Residual becomes smaller as the propagated state converges toward the actual. Second, the Kalman gain becomes smaller due to the “shrinking” covariance matrix as the software’s estimate of the state vector improves. The covariance matrix is depicted as a volume of uncertainty about the orbiter. The rate of convergence of the propagated state to the actual state depends upon the value of the Kalman gain, which is a function of the size of the covariance matrix and the sensor weight. Heavily weighted measurements, such as MLS, cause rapid convergence (within a few Nav cycles). Measurements that are not heavily weighted, such as drag H, cause very slow convergence.

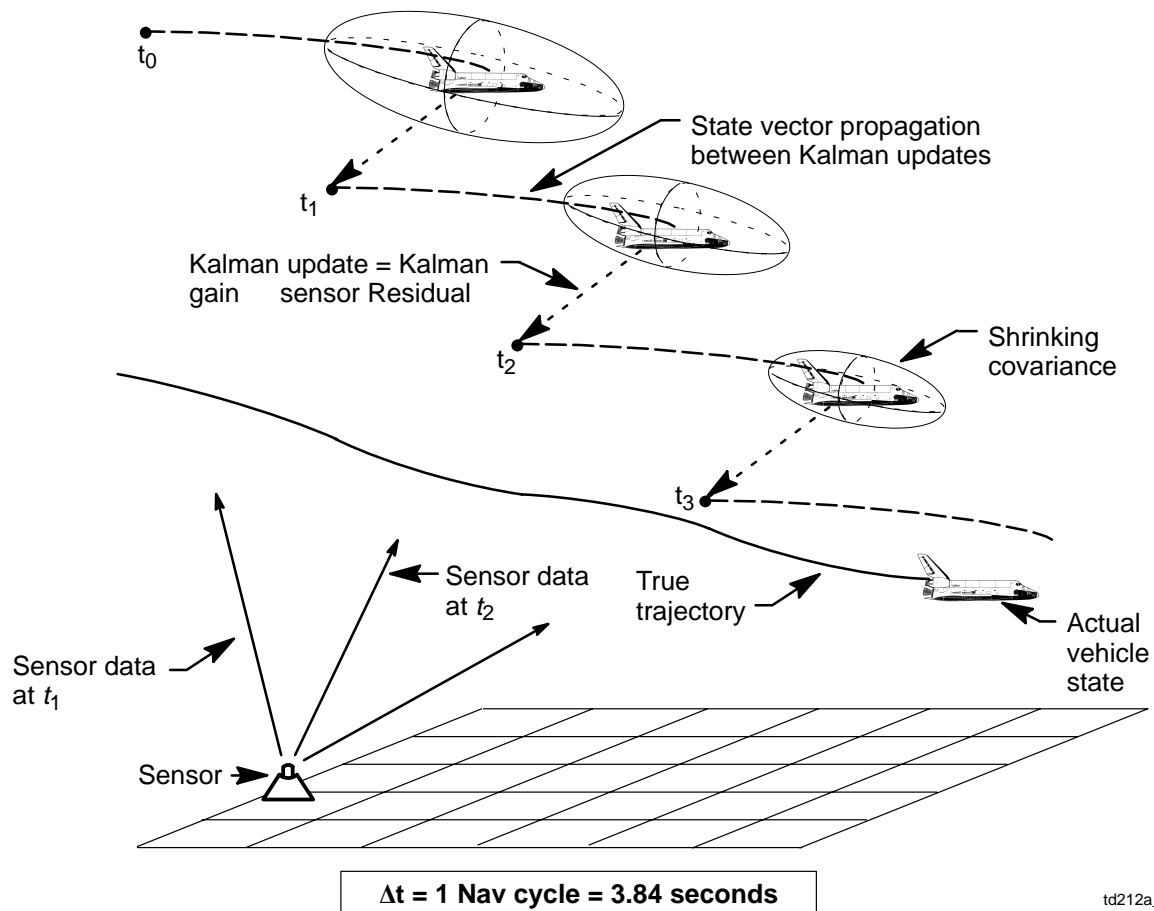

td212a_052

Figure 3–10. A representation of Kalman filter updating of the orbiter state vector with sensor data

One final term to define in Kalman filtering is the Ratio. The Ratio for a sensor parameter is the Residual for that parameter divided by its maximum allowable Residual, or $RATIO = Resid/Resid_{max}$. A Ratio for each parameter available to the filter is calculated once per Nav cycle. The maximum allowable Residual varies proportionally with the size of the covariance matrix, starting with I-load initial values ($Resid_{max}$ is large for an open covariance). The Ratios for drag H, TACAN bearing and range, and baro-altitude are displayed to the crew on SPEC 50 during Entry as each parameter becomes available to the filter (see Figure 3–11).

The Ratio values assist the crew in assessing the health of the onboard state vector, or the health of the sensor data. Based upon this assessment, the crew determines whether to inhibit the sensor data from updating the state vector or allow updating automatically by the software. The crew then exercises the Inhibit (INH) or Auto (AUT) filter options, respectively, on SPEC 50 (Figure 3–11). While in auto, the filter automatically uses the data if the data pass a Ratio Edit Test, whereby the Ratio is less than one ($Resid < Resid_{max}$). While in auto and if the Ratio is greater than one, the data are inhibited from use. In this case, we say the data are edited. A third filter option, Force (FOR) causes the filter to bypass the Ratio Edit Test, thereby “forcing” the filter to update the state vector with the sensor data regardless of the sensor Ratio. Ideally, a $Ratio < 1$ should be good sensor data. However, due to the conservatism designed into the orbiter software, Ratios ≥ 0.3 are typically a cause for concern in both Entry and Rendezvous navigation.

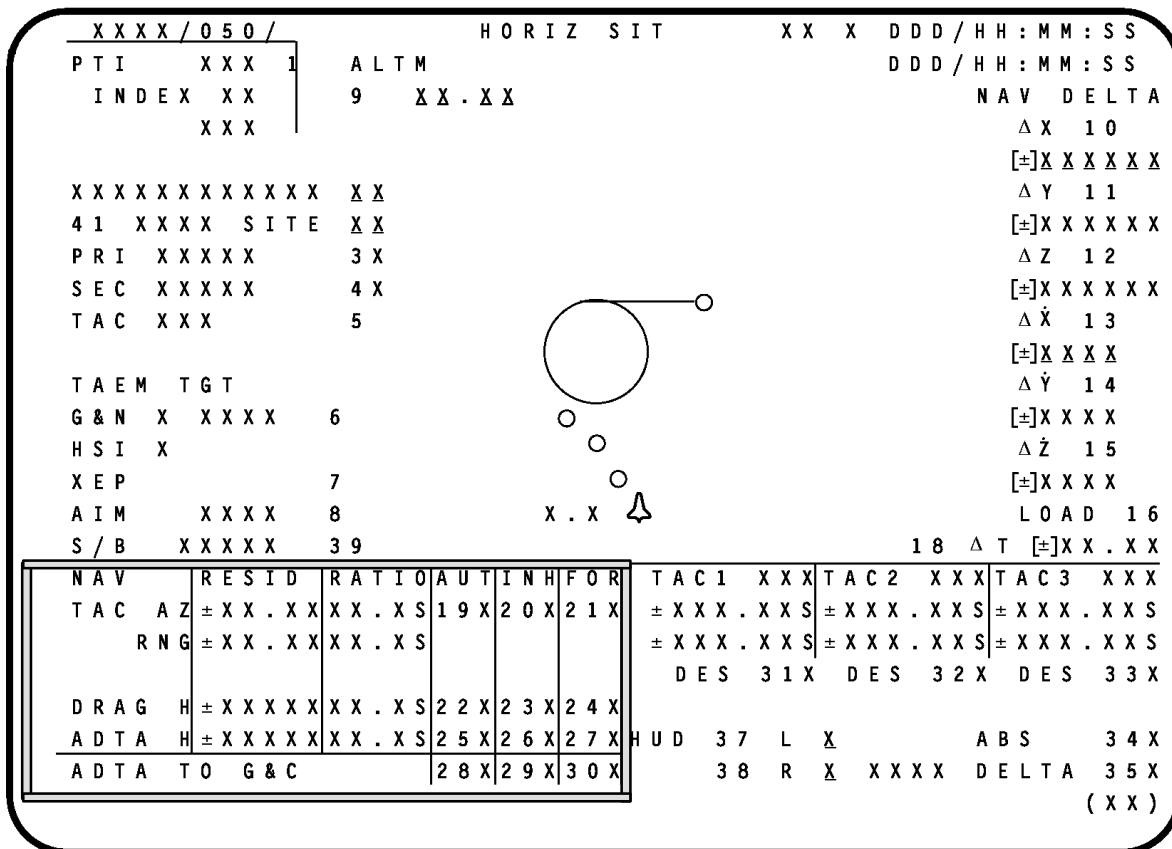

td212a_024

Figure 3-11. HORIZ SIT display – Residuals, Ratios, and filter controls

In summary, the general operation of the Kalman filter during Entry is as follows (Kalman filtering during other phases of flight is similar):

Note: The following sequence is performed by the software once per Nav cycle for each sensor parameter that is processed by the Kalman filter.

- a. Get the state vector (with time tag t) propagated from Super-G Nav. This is the best estimate of the previous position and velocity.
- b. Propagate the covariance matrix to time t.
- c. Get measurement, M, at time t (such as TACAN slant range).
- d. Using the propagated state vector, compute the expected measurement, M_e .
- e. Calculate the Residual, $Resid = M - M_e$. This will be displayed to the crew on SPEC 50 in the RESID column.
- f. Compute the maximum acceptable measurement error, $Resid_{max}$. This will be used to prevent the Kalman filter from using bad sensor data.
- g. Form ratio, $\frac{Resid}{Resid_{max}}$. This is displayed on SPEC 50 in the RATIO column.

- h. Check SPEC 50 for the Auto/Inhibit/Force (AUT/INH/FOR) selection for the type of measurement being processed.
 - (1) If in INHIBIT, ignore the measurement.
 - (2) If in AUTO, perform the Ratio Edit Test. In this test, if the Ratio ≥ 1 , the data are not incorporated; i.e., it is edited. If the Ratio is < 1 , the data are incorporated.
 - (3) If in FORCE, the measurement data are incorporated regardless of the Ratio.
- i. If the measurement data are to be incorporated, calculate the Kalman gain based upon the covariance matrix and sensor weight.
- j. Update the Super-G Nav state vector using the Residual and Kalman gain.
- k. Output the filtered state vector.

Questions

Answers to the following questions can be found in Appendix B.

1. List the parameters that are supplied to the Kalman filter by the following navigation aids:
 - Drag H
 - TACANS
 - ADS
 - MLS
2. Name the navigation sensors that can be used during Rendezvous navigation for state vector filtering.
3. How is the Residual defined for a given sensor parameter?
4. How is the Ratio defined for a given sensor parameter?
5. How is a sensor measurement used by the Kalman filter to update the state vector?
6. Mathematically describe the covariance matrix. How can one conceptually describe the covariance matrix?
7. What is meant by the terms “open” covariance matrix and “shrinking” covariance matrix? What are the effects of an “open” and “shrunk” covariance matrix on state vector updating?
8. Which Entry sensor is given the greatest sensor weight for Kalman filtering? The least?
9. What do the filter controls AUT, INH, and FOR on SPEC 50 mean?

Section 4

State Vector Updates

Objectives

Upon completion of this section, you should be able to

- Describe the differences between a whole state and delta state vector update
- Define voice delta state vector update and identify when it is used
- Define zero delta state vector update and identify when it is used
- Explain the two ways to transfer a state vector from PASS to BFS

Overview

Despite the rigorous navigation scheme the onboard software employs, the orbiter's calculated state vector may diverge from the actual state vector enough to warrant corrective action by MCC. Errors in the onboard state vector result from the following: approximations employed by the Super-G equations of motion and models, possible biases in the IMU data, and possible biases in the Nav aid sensor data.

The MCC maintains an accurate knowledge of the vehicle's position and velocity, using TDRS ranging data, radar tracking data, and state vector prediction computations. It also receives the orbiter's onboard-computed state vector via the downlist. From these, it keeps track of the difference between the two. MCC attempts to correct the onboard state vector when the position or velocity deltas exceed limits specified by flight rules. The magnitudes of these limits are dependent upon mission phase. As an example of the limits, when the orbiter altitude is less than 130 kft during Entry, the orbiter state vector is updated by MCC if the velocity component errors exceed 75 fps or position component errors exceed 6 kft.

It is possible for the MCC to uplink either a completely new User state vector (a "whole state vector update") or simply deltas to the onboard User state vector (a "delta" state vector update). Which choice is used depends on the flight phase. In addition, if command uplink is unavailable during flight, MCC may uplink by voice the required changes to the User state vector and have the crew implement the update via CRT inputs. This is referred to as a "voice" delta state vector update.

The whole and delta state vector update capability exists for the PASS and BFS. However, the preengaged BFS typically has its state vector updated by the crew using a PASS-to-BFS state vector transfer, as opposed to a direct uplink from the ground.

Whole State Vector Update

In OPS 1, 2, and 3, it is possible for the MCC to uplink a new User state vector. The orbiter must have TDRS communication or be over a ground station with S-band capability for the uplink to be possible. The whole state vector update capability is not normally used during powered or atmospheric (dynamic) flight as it involves taking the uplinked state vector and

“predicting” it forward or backwards to the current time. This can lead to errors in the new state if the vehicle is accelerating, such as in dynamic flight.

During orbit, the onboard state vector propagation scheme can maintain the vehicle state accurately enough for several hours to meet Entry guidance requirements. Periods of high RCS activity (attitude and small translation maneuvers), onboard water dumps, and Auxiliary Power Unit (APU) venting can increase the rate at which the onboard state vector degrades. Whole state vector updates are made periodically during orbit to maintain adequate onboard navigation (maximum downtrack error of 20 n. mi.) to provide contingency deorbit capability as specified by flight rule limits for the case when ground communication is lost. In addition, whole state vector updates may be planned to satisfy mission or payload requirements.

A whole state vector update is accomplished by MCC as an uplink of a new state vector (all six components) in M50 coordinates plus a time tag. An onboard navigation software algorithm, the precise predictor, is used to propagate the uplinked state vector forward or backwards to the current time. IMU data are not used for this propagation. The current onboard User state vector is then replaced by the uplinked state vector.

If it is not possible for MCC to uplink a state vector, there exists onboard a GPC Memory (GMEM) READ/WRITE procedure in which the crew manually loads the new state vector via Item entry in the GPC MEMORY display. The new state vector must be voiced up to the crew by MCC. As this procedure is time consuming and a crew error can have serious results, it is used only if the situation is critical.

Delta State Vector Update

During OPS 1, 3, and 6, it is possible for the MCC to send uplink commands to update the position and/or velocity components of the User state vector by the differences, or deltas, between the ground and onboard-computed state vectors. To do this, MCC propagates to a future time the downlisted User state vector and the state vector that is derived from ground tracking. MCC computes the deltas between these two states at the specified future time and uplinks the deltas in runway coordinates. The deltas are converted to M50 coordinates onboard and incorporated into the User state vector to form the new User state vector.

During the OPS 3 Entry navigation phase of flight (three state vector scheme), the new User state vector is subsequently input to Super-G Nav and becomes the initial condition for each of the three state vectors. In other words, Super-G Nav state vectors 1, 2, and 3 are replaced by the new User state vector. (Super-G Nav is a “user” of the User state vector!) After being reset to the new User state, the three state vectors resume their independent propagation, as described in Section 2.

Another result of a delta state vector update is that the Kalman filter (see Section 3) is reinitialized with a “special” covariance matrix. The elements of the matrix are computed from parameters that are premission loaded and that are based upon the errors in the onboard state vector that are expected following a delta state vector update. The special covariance matrix is initialized in an “open” state. This results in a large Kalman gain associated with any subsequent Nav aid sensor data immediately following the delta state update.

Delta state updates are typically performed during dynamic phases of flight as needed to maintain the accuracy of the onboard state vector within flight rule limits. Uplinking deltas to

the onboard state vector during dynamic flight is safer than uplinking a whole state because of potential operator error; for example, a ∞ or Δ error in one of the components would have less severe impact on the state vector than a whole component error.

Another capability available in OPS 3 is to correct downrange error by uplinking a delta time (ΔT) in the onboard state vector. This is referred to as a “ ΔT update.” Essentially, this technique tells the software that the present state vector should really be the state vector a few seconds earlier or later. Pre-TDRS, this technique was typically done over the Guam tracking site during Entry. Hence it is sometimes referred to as the “Guam trick.” The ΔT update is rarely used.

Voice Delta State Vector Update

It is also possible for the crew to manually enter a delta state vector update via Item entry to SPEC 50. This is done only if the ground loses command uplink capability while retaining voice uplink and downlist capability. See Figure 4–1 for the crew item entries to perform a “voice” delta state update. The entire voice delta procedure requires strict coordination between the MCC and the crew. Note that the MCC typically gives a time at which the crew is to execute the “load” of the delta. The crew should execute the update as close to this time as possible to increase the accuracy of the new state for the case where the onboard and ground-computed state vectors are diverging.

The voice delta state item entries (Items 10–15 on SPEC 50) are expressed in runway coordinates. The sense of the inputs is ground estimated minus onboard computed. Instead of entering position and velocity updates, MCC may advise the crew to manually perform a ΔT update via Item 18.

XXXX / 050 /		HORIZ SIT		XX X DDD / HH:MM:SS	
PTI XXX 1	ALTM			DDD / HH:MM:SS	
INDEX XX	9 XX.XX				
XXX					
XXXXXXXXXXXXXXXXXX	XX				
41 XXXX SITE	XX				
PRI XXXXX	3X				
SEC XXXXX	4X				
TAC XXX	5				
TAEM TGT					
G&N X XXXX	6				
HSI X					
XEP	7				
AIM XXXX	8				
S/B XXXXX	39				
				18 Δ T [±]XX.XX	
NAV RESID RATIO	AUT IN H FOR	TAC1 XXX	TAC2 XXX	TAC3 XXX	
TAC AZ ±XX.XX	XX.XS	19X	20X	21X	±XXX.XXS ±XXX.XXS ±XXX.XXS
RNG ±XX.XX	XX.XS				±XXX.XXS ±XXX.XXS ±XXX.XXS
		DES 31X	DES 32X	DES 33X	
DRAG H ±XXXXX	XX.XS	22X	23X	24X	
ADTA H ±XXXXX	XX.XS	25X	26X	27X	HUD 37 L X ABS 34X
ADTA TO G&C		28X	29X	30X	38 R X XXXX DELTA 35X
					(XX)

td212a_025

Crew-performed voice delta state item entries:

- Enter ΔX , ΔY , ΔZ (position components) and $\Delta \dot{X}$, $\Delta \dot{Y}$, $\Delta \dot{Z}$ (velocity components) values in Items 10–15.
- Verify that the correct values are entered.
- Load the deltas with an ITEM 16 EXEC. Items 10–15 will blank after update is complete.

Figure 4-1. Item entries for a “voice” delta state vector update

Zero Delta State Vector Update

A procedure similar to the voice delta state vector update, called a “zero” delta state update, requires the crew to incorporate “zero” delta corrections to the state vector; that is, add 0 ft and 0 ft/s to the User state vector position and velocity components, respectively. This is accomplished with an Item 16 “Load” command, where all deltas (Items 10 through 15) are zero.

This procedure does not change the User state vector but is used by the crew in OPS 3 Entry to recover from certain IMU failure scenarios. This is best described by way of example, as follows (refer to the three state vector scheme discussion in Section 2).

Suppose, while in OPS 3, the data from IMU 3 are no longer available to the GPCs for processing due to a failure. (We say the IMU is communication faulted, or comm faulted for short.) Then the User state vector becomes the average of state vectors 1 and 2. Assuming state vectors 1 and 2 are good, then the User state is also good. State vector 3 is no longer available to the Vector Selector (IMU 3 is deselected); however, state vector 3 continues to be propagated by Super-G Nav based upon the “last-sensed” accelerations from IMU 3. That is, Super-G Nav uses the last acceleration data it received from IMU 3, just prior to the failure, to propagate state vector 3. Therefore, state vector 3 diverges from the User state vector if the shuttle undergoes any change in acceleration.

Now suppose IMU 3 is recovered by the crew and no longer comm faulted. State vector 3 propagates with good IMU data again. However, the initial conditions are still bad (Super-G Nav incorporates good IMU data into an already bad state vector 3), resulting in a still bad state vector 3. This is where the zero delta state update can be used. One result of the Item 16 “LOAD” to SPEC 50 is that state vectors 1, 2, and 3 are replaced by the User state vector; that is, the User state is input into Super-G Nav and becomes the initial condition for each state vector, as previously described for delta state vector updates. In our example, this action “fixes” the initial conditions for state vector 3. With good acceleration data from IMU 3, it can be reselected by the crew, and navigation is back to the three-level of redundancy in state vectors.

In summary, the primary use of a zero delta state vector update, or “Nav delta zero” for short, is to provide a means for the crew to recover temporarily commfaulted IMUs in OPS 3. The Nav delta zero does this by feeding the good User state vector back into Super-G Nav to reset each of the three state vectors.

A Nav delta zero may also be performed by the crew in OPS 3 to increase the Kalman gain of Nav aid sensor data. As previously discussed, following a delta state vector update in OPS 3 (delta, voice delta, or zero delta), navigation software reinitializes the Kalman filter covariance matrix to an “open” state. For this reason, the crew may perform a Nav delta zero if the resulting increase in the Kalman gain of subsequent sensor data (usually TACANS) would improve the accuracy of the onboard state vector. Normally, MCC would make this determination and advise the crew.

There is a case where the covariance matrix reinitialization of Nav delta zero can degrade the state vector. If the crew performs a Nav delta zero (to recover an IMU) immediately before TACAN incorporation, then the Kalman gain of the TACAN data is dramatically increased. In the presence of a nominal TACAN range Residual (≈ 2 n. mi.), this can cause undesirably large velocity component updates to the state vector (recall that Kalman update = Kalman gain Residual). To avoid this scenario, the OPS 3 Flight Data File (FDF) procedures for IMU recovery direct the crew to refrain from Nav delta zeros between the altitude of 200 kft and TACAN incorporation (200 kft is used as a reference point about 5 minutes before normal TACAN incorporation at about 140 kft). This allows sufficient time for the covariance matrix to “shrink” (and Kalman gain decrease) prior to TACAN incorporation, following a Nav delta zero above 200 kft.

When the crew executes a LOAD, the BFS substitutes the propagated PASS state vector for its own. Thus, in general, the crew should not delay executing the LOAD of the PASS state vector because the BFS-propagated PASS state vector may diverge from the actual PASS state vector. After the BFS completes the load of the PASS state vector, the displayed deltas will zero. If the crew decides not to load the deltas, they could zero the deltas by reentering ITEM 17 EXEC. This causes Items 10 to 15 to blank and is a safety feature to prevent an accidental load of old data.

The other case in which the preengaged BFS uses the PASS state vector is on a BFS OPS transition to OPS 3 from OPS 0. On the OPS transition, the BFS snaps the PASS state vector and performs the reasonableness test. If the PASS state vector fails the test, "RM FAIL XFER" is annunciated, and the BFS uses the last state vector stored in its memory. If the PASS state vector passes the test, it will replace the BFS state vector.

Questions

Answers to the following questions are in Appendix B.

1. Define a whole state vector update. When is the update performed?
2. Define a delta state vector update. When is the update performed?
3. Define voice delta state vector update. When is the update performed?
4. Define zero delta state vector update. When is the update performed?
5. State two ways that the PASS state vector can be transferred to the BFS.

Section 5

Navigation by Mission Phase

Objectives

After completion of this section, you should be able to

- Describe the role of the crew in state vector management for the various phases of flight
- List the actions required to enable Rendezvous navigation
- Identify the approximate windows of availability (altitude ranges) within which the various navigation aid sensors are typically used for state vector filtering during Entry
- Describe the meanings of the navigation-related steps on the Entry Maneuvers cue card of the FDF
- State the primary differences between OPS 3 Entry and RTLS navigation
- State the primary differences between PASS and BFS navigation

Overview

The previous sections have described the basic terms and functions in the calculation and maintenance of the shuttle state vector. The crew and MCC management of the state vector to maintain its health (accuracy) varies with the different phases of flight. Also, the crew visibility into the health of the state vector varies with each phase. This section discusses these topics. If you are not familiar with navigation terminology, refer to the discussions in previous sections.

Ascent Navigation

Ascent navigation is initialized at T – 8 seconds, at which time the geodetic location of the navigation base and the Earth's angular velocity vector are transformed into an M50 state vector. The M50 state vector is then propagated using the Super-G algorithm throughout the Ascent flight phase, using either sensed accelerations from the IMUs or modeled drag accelerations. Kalman filtering is not active during Ascent navigation. At the end of MM 106, the state vector and the time tag are saved to carry over into the next OPS (OPS 2, nominal; or OPS 3, TAL or AOA; or OPS 3 in the BFS) for initialization.

Pre-Main Engine Cutoff (MECO), the MCC monitors the onboard PASS and BFS navigation performance and is prepared to make state vector updates, as required, to protect MECO conditions. A small navigational error at MECO can cause significant errors in the vehicle trajectory. If necessary, assuming the BFS is not engaged, the MCC uplinks a delta state update directly to the PASS. Once the state vector has been corrected in the PASS, the crew can update the BFS state vector with a PASS-to-BFS state vector transfer on BFS SPEC 50. If, however, the BFS is engaged and a state vector update is needed, the MCC uplinks a delta state update directly to the BFS.

Before each of the OMS 1 and OMS 2 burns, the MCC determines whether a whole state vector update is required. If a state vector update is done, the crew is asked to reload the OMS 1 or OMS 2 targets to check the results based on the corrected state vector. As before, the BFS state vector is updated with a PASS-to-BFS SV XFER, assuming the BFS is not engaged.

During Ascent, no external sensor data (drag H, TACAN, air data, or MLS) are available for the crew to compare with the onboard state vector. Hence the crew has little direct insight into the health of the onboard state vector.

Orbit (Nonrendezvous) Navigation

Orbit navigation is used in GNC OPS 2 and 8 and is active whenever Rendezvous navigation is not active. The orbiter state vector is propagated with the Super-G algorithm. As discussed in Section 2, the crew has the capability in MMs 201 and 801 to prevent navigation from using IMU-sensed acceleration by disabling the AVG G item on the SPEC 33 REL NAV display if in MM 201, or the FCS/DED DIS C/O display if in MM 801. Normally AVG G remains enabled, and in MM 202, it is always enabled.

In OPS 2 and OPS 8, the accelerometer data received from IMU RM have been corrected to an orbiter c.g.-centered reference frame instead of the IMU Nav-base-centered reference frame.

Recall from Section 2 that powered flight orbit navigation is enabled in MM 201 and 801 when AVG G is selected and is always enabled in MM 202. Powered flight navigation uses IMU-sensed acceleration if it exceeds a threshold (typically $1000 \sigma_g$), which occurs during an OMS or RCS translation. It also uses IMU-sensed acceleration if the ΔV accumulated during an attitude maneuver exceeds a threshold (0.09 ft/s).

While on orbit, the crew has limited visibility into the health of the onboard Nav state. With an IMU alignment, the crew can determine whether the IMUs have been drifting in attitude. Attitude errors contribute to errors in the accelerometer output, which can degrade the state vector. The crew can also compare the IMU accelerometer outputs as shown on the IMU ALIGN display (see Figure 5-1). Differences between the three IMUs can indicate a problem.

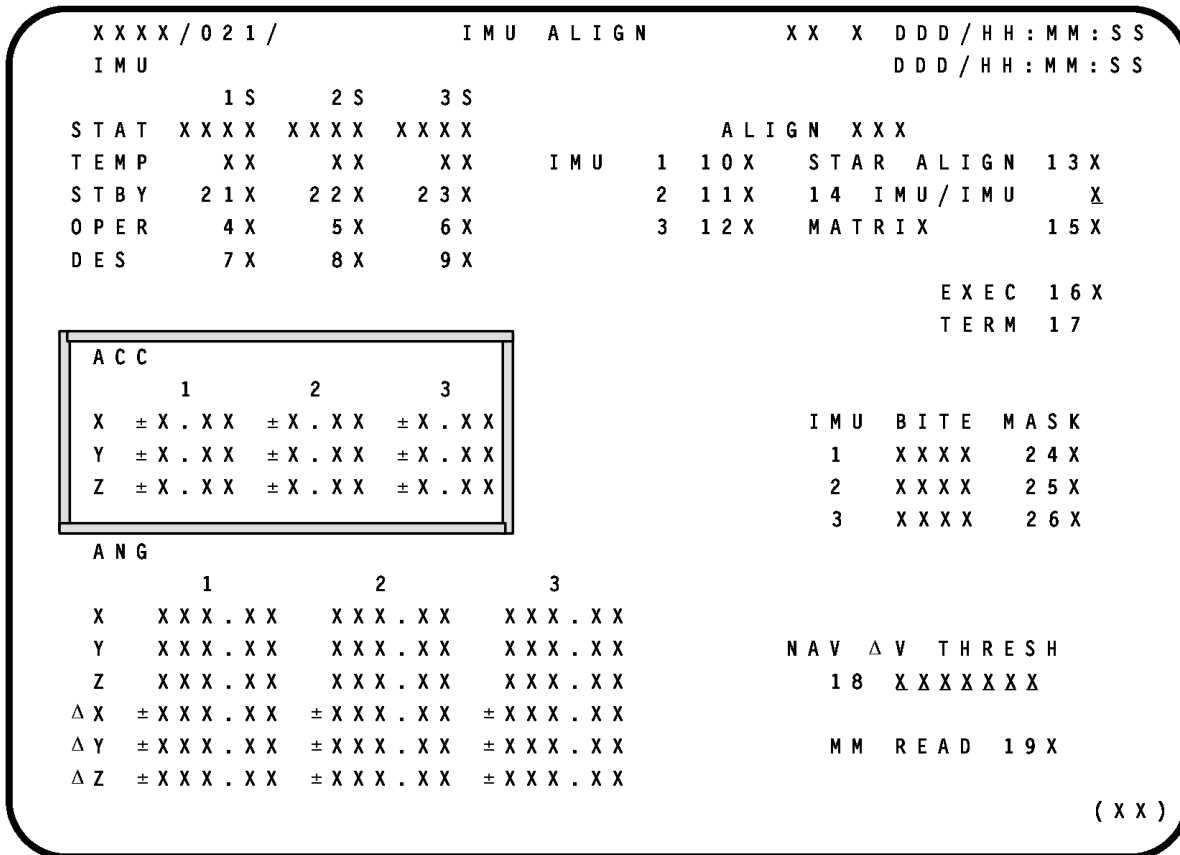

td212a_028

Figure 5-1. IMU ALIGN display – IMU-sensed accelerations

During orbit, the crew is dependent upon MCC for state vector corrections. In OPS 2, MCC uses whole state vector updates (not deltas). MCC also has uplink command capability to adjust the onboard state vector to compensate for venting and changes in the vehicle reference area (which is used in drag computations) due to certain payload configurations. This capability is described in the drag and vent model subsections of Section 2.

Rendezvous Navigation

Rendezvous navigation includes the software to maintain an accurate estimate of both the orbiter and target state vectors. The primary crew interface with Rendezvous navigation is the REL NAV display (Figure 5-2). A complete description of the display and its use in rendezvous can be found in the RNDZ 2102 Workbook.

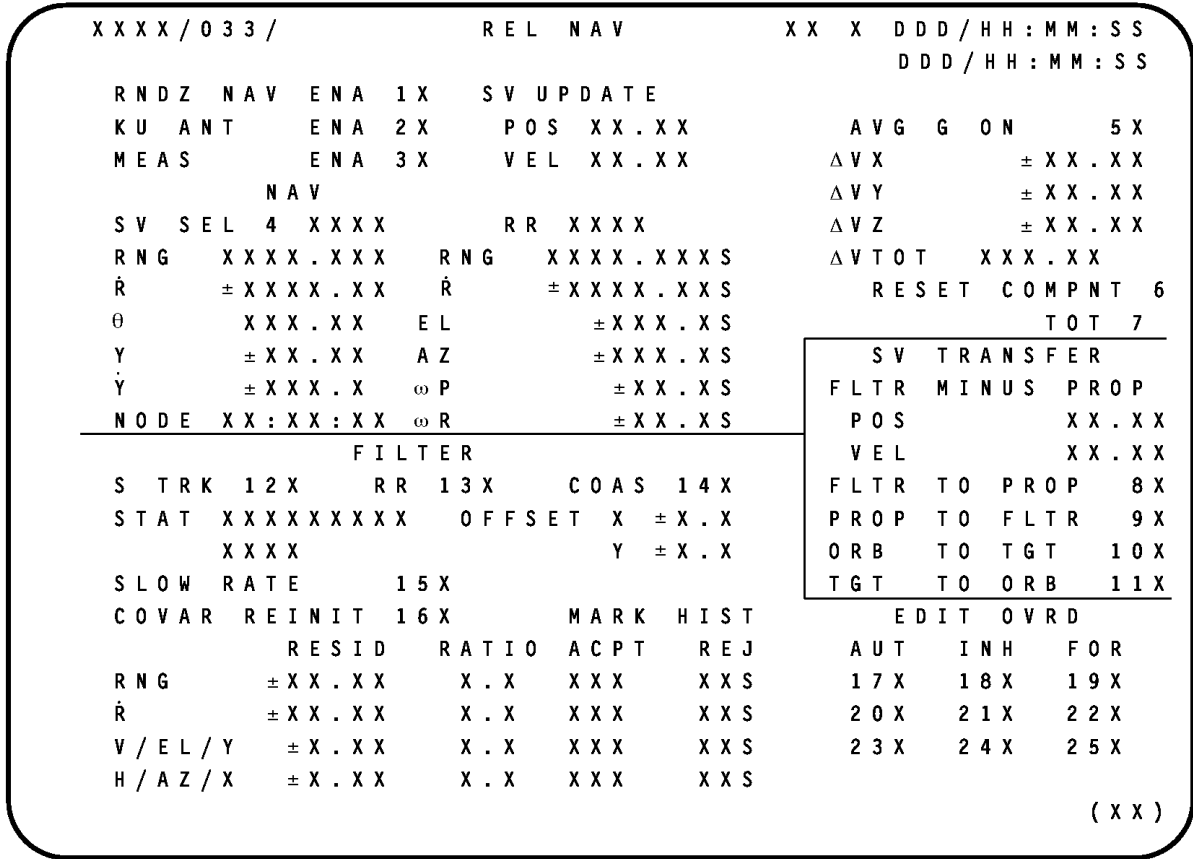

td212a_029

Figure 5-2. REL NAV display

Rendezvous navigation is enabled in OPS 2 by execution of Item 1 on the REL NAV display. When it is enabled, both the orbiter and target state vector are propagated using the Super-G algorithm. Modeled drag acceleration or IMU-sensed acceleration is used to propagate the orbiter state vector based upon the same criteria as in orbit navigation. Since Rendezvous Nav maintains state vectors for both the orbiter and target, an initial target state vector must be uplinked to the orbiter by MCC before Rendezvous Nav can be enabled.

External sensor data are available for Kalman filtering using the RR, ST, or COAS during rendezvous navigation. These sensors provide target position data relative to the orbiter. Therefore in using these data for state vector filtering, an assumption must be made whether the orbiter or target state vector is “good.” Preflight, determination is made as to which of the two is expected to have the most stable state vector. Typically, if the target does not have translation capability and it has small drag, the target is considered more stable, and its state vector is used as a reference. In that case, in addition to maintaining a simple Super-G propagated orbiter state vector (the PROP state vector), Rendezvous navigation also propagates an orbiter Filter (FLTR) state vector that incorporates the sensor data.

Recall from Section 3 that the following data may be acquired from the external sensors.

- The RR provides range (RNG), range rate (\dot{R}), azimuth (AZ), and elevation (EL) angles relative to the target. These data, as well as pitch angle rate (\dot{P}) and roll angle rate (\dot{P}), are displayed on REL NAV.
- The ST provides horizontal (H) and vertical (V) angles to the target when in the TARGET TRACK mode on SPEC 22.
- The COAS provides horizontal (X) and vertical (Y) angles to the target following a crew-initiated mark.

Only the RR provides range information, although either the RR, ST, or COAS can provide angular data on the position of the orbiter relative to the target. The crew selects the source of angular data via Item 12, 13, or 14 on the REL NAV display. Only one can be selected. Which sensor is selected is based upon the size, brightness, and range of the target.

The Kalman filter updates only the FLTR state vector with RR, ST, or COAS data. The crew can monitor the effect of the sensor data on the FLTR state vector under the SV UPDATE caption on the REL NAV display. The PROP state vector is not updated with sensor data. Therefore, in the event that biased sensor data degrade the FLTR state vector, the PROP state vector is available as a backup. Periodically during a rendezvous, the crew overwrites the PROP state vector with the FLTR state vector, assuming the FLTR state has been updated with good sensor data, using the FLTR TO PROP item entry (Item 8) in the SV TRANSFER portion of the REL NAV display.

OPS 3 Navigation

Overview

Navigation during PASS OPS 3 (nominal Entry, Transoceanic Abort Landing (TAL) or Abort Once Around (AOA)) is subdivided into Entry navigation and Pre-land navigation. Entry navigation is used from OPS 301 until MLS acquisition at about 18 kft. Pre-land navigation is used from MLS acquisition to landing.

During Entry navigation, three state vectors are propagated using the Super-G algorithm, such that each IMU is used to generate its own state vector. A vector selection process is then used to build a composite state vector, or User state vector. A Kalman filter is used to blend external sensor data (drag H, TACANS, ADS) into the three Super-G Nav state vectors to produce the best possible estimate of the orbiter's position and velocity.

During Pre-land navigation, only one state vector is propagated using the single state vector scheme, and the Nav cycle is 1.92 seconds rather than the 3.84-second cycle used during Entry navigation. A Kalman filter is used to incorporate MLS data. The faster rate in Pre-land allows a more accurate state vector calculation.

Both delta state and whole state updates are possible during OPS 3. However, only delta state vector updates are used during atmospheric flight (below 400 kft altitude). The crew performs an IMU alignment close to the deorbit time, and MCC corrects the orbiter state vector, as

required. MCC typically does not uplink corrections to the BFS state vector directly. Instead, MCC has crewmembers execute a PASS-to-BFS state vector transfer, when required.

Deorbit Prep to Entry Interface

During the deorbit prep timeframe, the crew configures the orbiter for Entry. This includes powering on the Nav aid sensors and configuring them for the selected landing site. Flight software contains landing site information for nominal end-of-mission and abort sites in its landing site software table. If the selected landing site is not built into the table, MCC can uplink the site information to the orbiter. The landing site is selected by the crew on SPEC 50 (see Figure 5-3). To select a landing site (for which the deorbit burn targets are calculated), the crew enters the site number of the desired location into Item 41.

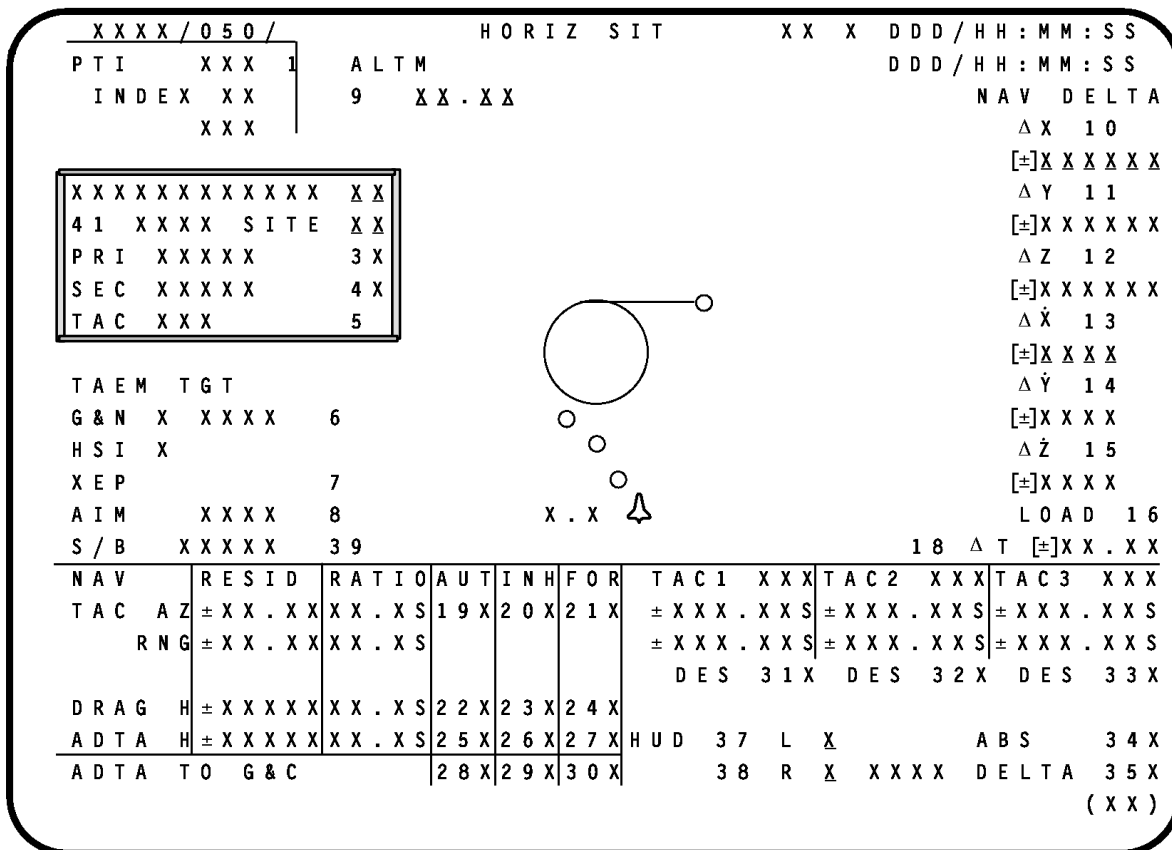

td212a_031

Figure 5-3. HORIZ SIT display – landing site, runway, and TACAN station select

A table of the landing sites that are contained in the flight software is available for crew reference in the Entry Checklist of the FDF. Figure 5–4 shows an example of the landing site table. Each site consists of two runways, primary and secondary; as many as two TACAN stations, primary and secondary; and as many as two MLS stations. Figure 5–4 also shows the runway (RWY) IDs for the various sites and the TACANS and MLS channel IDs. Note that MLS is not available at all sites.

**STS-63
LANDING SITE TABLE
(OPS 1/6/3)
(50° to 63.5° INCLINATION)**

SITE	LOCATION	RWY	TACANS		MLS CH	LG
				ITEM 5		
1	KSC	KSC 15 KSC 33	TTS 59Y	COF 97	8 6	15000 15000
2	BEN GUERIR	BEN 36 BEN 18	BEN 118	CBA116 (DME)	6 -	13720 12720
3	MORON	MRN 20 MRN 02	MRN 100	AOG 23	6 -	12000 11800
4	ZARAGOZA	ZZA 30L ZZA 12R	ZZA 64	ZZA77 (DME)	6 -	12397 12197
5	MYRTLE BEACH	MYR 35 MYR 17	FLO 99	ILM 117	- -	9502 9502
6	CHERRY POINT	NKT 32L NKT 23R	NKT 75	NJM 67	- -	8400 9000
7						

td212a_032

Figure 5–4. Entry Checklist Landing Site Table

Items 3 and 4 on SPEC 50 allow the crew to select either the primary or secondary runway for the selected landing site. Item 5 provides the capability to select either the primary or secondary TACAN station. When a landing site is selected, the primary TACAN station is automatically selected. Subsequent executions of Item 5 alternately select the secondary and primary TACAN stations. The channel ID of the selected TACAN station is displayed next to Item 5. More information on the landing site portion of SPEC 50 can be found in the FDF Data Processing System (DPS) Dictionary.

Following the deorbit burn, the crew makes a final check of the Nav sensor configuration before Entry Interface (EI) with the atmosphere. The EI is defined as an altitude of 400 kft. This Entry Checklist callout is shown in Figure 5–5. The crew ensures that the MLS and TACAN switches on panels O7 and O8 are properly configured (as well as Radar Altimeter (RA)), and the proper MLS and TACAN channels are selected, according to the landing site table in the FDF. Details on the operation of these sensor controls are found in the NAV AIDS 2102 Training Manual. Prior to EI, the orbiter state vector is corrected via whole state vector updates by MCC if required.

NOTE

If NAV AIDS OFF due to PKT C/L
PWRDN, switch ON per PWRDN
procedure

- | | | |
|---|----|---|
| C | F7 | ✓RADAR ALTM – 1 |
| P | F8 | – 2 |
| | O8 | ✓RADAR ALTM (two) – ON
✓MLS (three) – ON (PASS)
✓MLS CH (three), FS 3–2 |
| | O7 | ✓TACAN MODE (three) – GPC
✓ANT SEL (three) – AUTO |
| | | ✓TACAN CH (three), FS 3–2 |

3–39

ENT/ALL/GEN D

td212a_033

Figure 5–5. Entry Checklist callout at approximately EI – 15 minutes to verify Nav sensor configuration

Entry Interface to Landing

In the final stages of a mission, EI through landing, the crew takes on an active role in the management of the orbiter state vector. The crew activities involve data management from the drag H, TACAN, air data, and MLS sensors.

An overview of the availability of the external sensors for a nominal Entry is shown in Figure 5–6. The figure shows the typical altitudes and Mach at which the various sensor data (drag H, TACAN, air data, and MLS) are used for state vector filtering, as indicated by the shaded regions. This figure is also referenced in the following discussion of sensor management. Note that RA data are used for crew display only; the data are not used for state vector filtering.

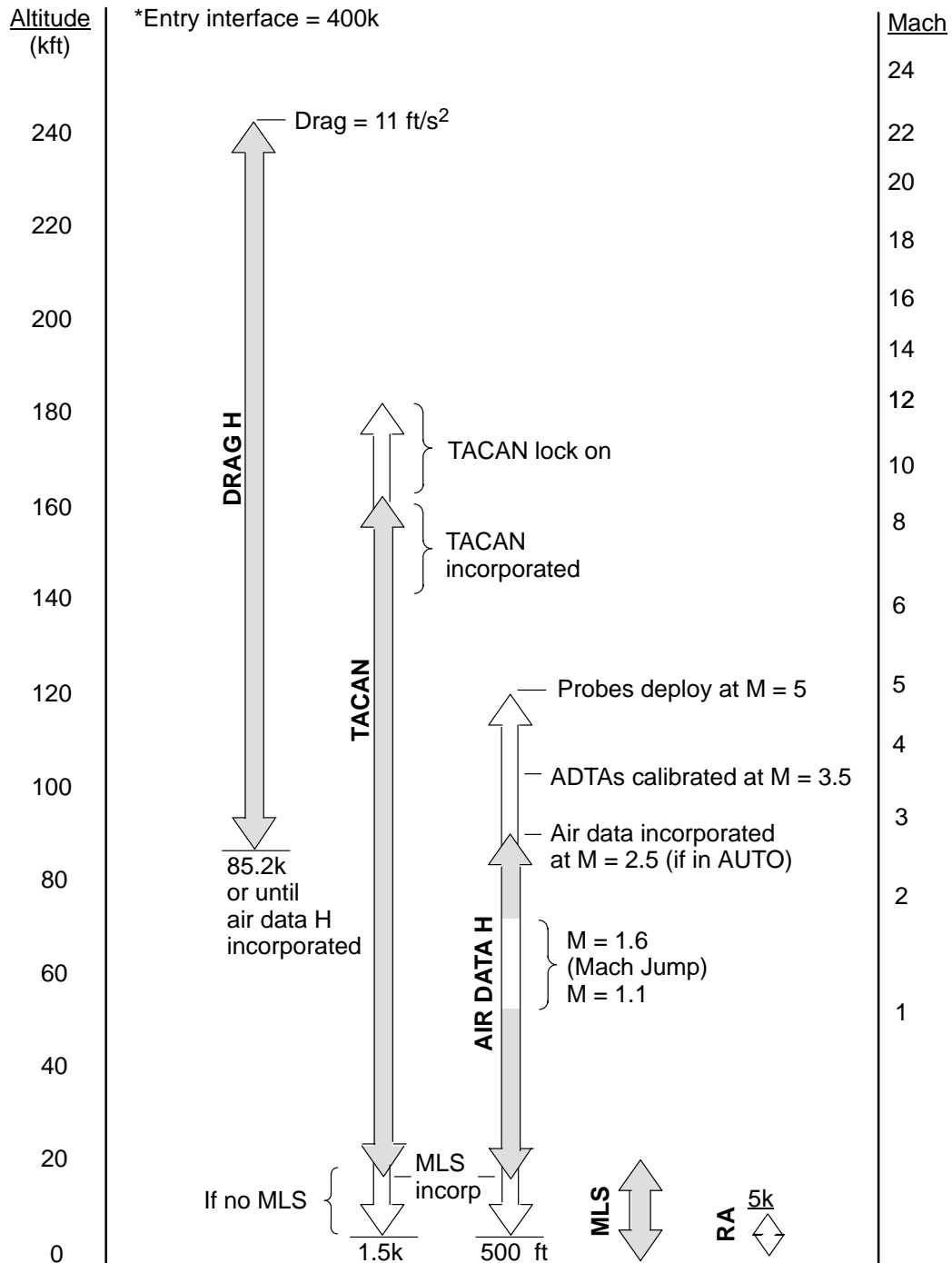

td212_030

Figure 5-6. Entry Nav aid sensors as a function of altitude and Mach for a typical Entry (shaded areas indicate sensor use for state vector filtering)

The crew incorporates the data for state vector filtering through use of the filter controls on SPEC 50 (see Figure 5-7). Three filter control options are Auto (AUT), Inhibit (INH), and Force (FOR), which the crew can exercise on three sensors: TACAN (TAC AZ and RNG), drag altitude (DRAG H), and baro-altitude (ADTA H). Items 19, 22, and 25 (AUT) allow navigation to automatically use sensor data for state vector updating if the data pass the Ratio Edit Test. Items 20, 23, and 26 (INH) inhibit the sensor data from updating the state vector, but these data are still used by the filter to generate the displayed RESIDUAL and RATIO values. Items 21, 24, and 27 (FOR) bypass the edit test and force the sensor data to be used for state vector updating if the data are available to the Nav filter. An asterisk (*) appears next to any item (19 to 27) that has been selected. The display is initialized with Item 20 (TACAN) in INH, ITEM 22 (DRAG H) in AUT, and Item 26 (ADTA H) in INH. Items 28 to 30 provide control over the source of air data parameters to guidance and flight control, as described later.

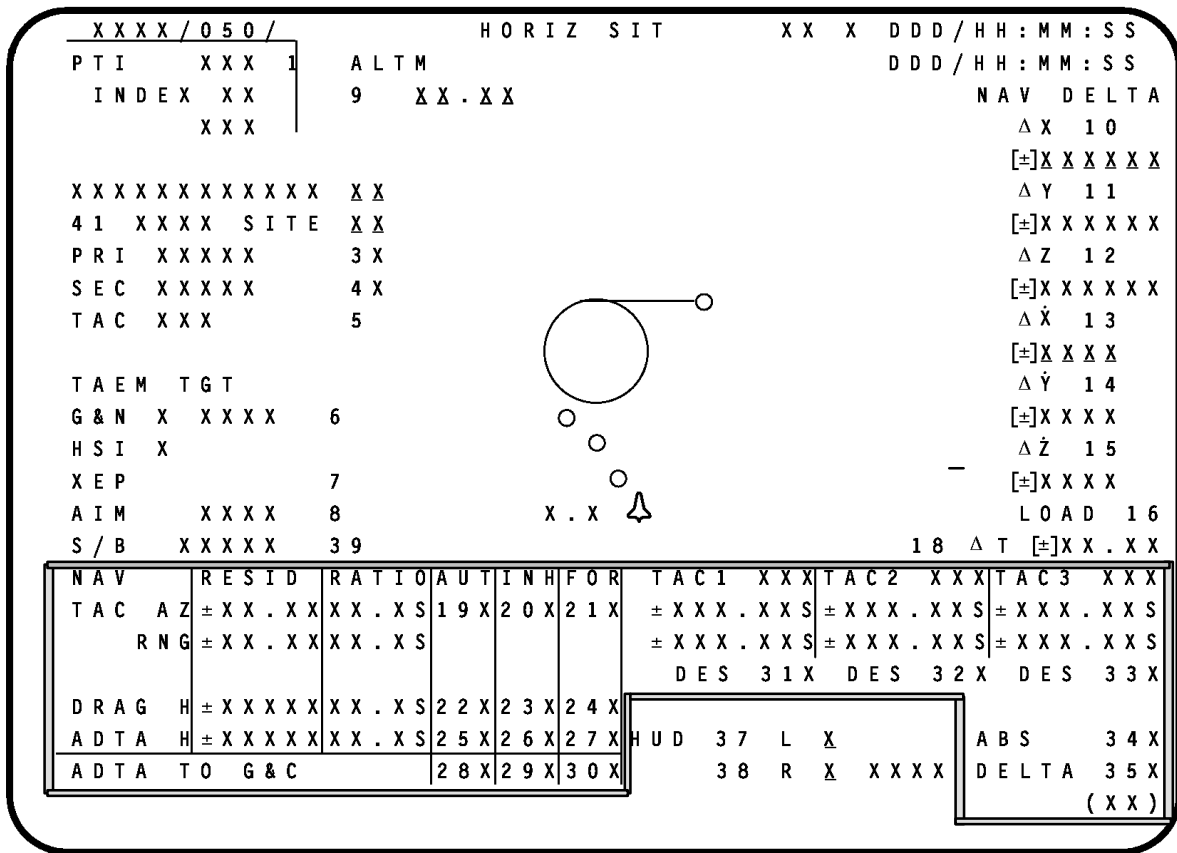

td212a_034

Figure 5-7. HORIZ SIT display – Nav filter controls and TACAN data

Beginning at EI – 5 minutes, the crew references the FDF Entry Maneuvers cue card for the remainder of the Entry. The cue card is shown in Figure 5–8, with the navigation–specific actions highlighted.

ENTRY MANEUVERS

FLIGHT CONDITIONS	MANEUVER
EI-5	✓LVLH ATT GNC, OPS 304 PRO * PREBANK <input type="text"/> <input type="text"/> (90° if AOA-S) * If previous OMS OX TK or He TK or RCS OX TK leak: <input type="text"/> VENT DOORS – OP PTI – ENA at EI-5 when applicable
EI-3	✓FWD RCS MANF ISOL 1,2,3,4 – CL (OP if FWD RCS PTIs SCHED)
\bar{q} = 1	(AOA) HYD MN PUMP PRESS (three) – NORM
'Guidance Box' @ \bar{q} ~8 or D ~3	CLOSED LOOP GUIDANCE _____:_____:_____ * If PREBANK, roll out PREBANK * * & follow first ROLLCMD (usually * * zero) at 3°/sec (TIME CRITICAL) * * WHEN ROLL = ROLLCMD, go AUTO *
D = 11	✓DRAG H (FORCE if editing)
V = 19K	✓MPS/TVC ISOL VLV – CL
V = 15K	✓NAVAIDS (I/O RESET if reqd) * If ELS: UHF MODE – G T/R *
V = 12K	RAD BYP VLV MODE (two) – AUTO CNTLR LOOP (two) – AUTO B(A) * If no YAW JET, begin lateral trim * * monitoring *
V = 10K	✓SPDBK to 81% * If three yaw jets failed on same side: * * Perform remaining roll reversals in * * R/Y – CSS *
	FIRST ROLL REVERSAL <input type="text"/> <input type="text"/> <input type="text"/> <input type="text"/>

MS ONLY ENT-6a/E/G 4-4 ENT/ALL/GEN D

td212a_035a

Figure 5–8. Entry Maneuvers cue card

FLIGHT CONDITIONS	MANEUVER
V = 7K	✓TACAN status
V = 5K	ADTA PROBES – DEPLOY (✓HEAT) Begin AIL and RUD trim monitoring
M = 4	Begin H monitoring (✓ < 500 fps)
M = 2.7	✓APUs HUD PWR (two) – ON
* If M < 2.5; P CSS for ADTA to G&C incorp *	
M = 2.0	Ensure ADTA to G&C else ✓Theta limits
M = 0.9	L TRIM PANEL – OFF RHC/PNL – ENABLE P, R/Y – CSS as req'd ✓SPDBK CMD vs POS MAX Nz <input type="text"/> ✓R FLT CNTLR – ON ✓NWS – 1
M = 0.7	✓LG EXTEND ISOL VLV – OP
h = 15K	✓MLS
h = 10K	✓A/L, TABS/VISORS – CL/LES O2 – ON (KSC)
MAIN GEAR TD	SPDBK – 100%
DEROT INIT	DRAG CHUTE pb (two) – ARM,DPY (simo)
NOSE GEAR TD	SRB SEP – MAN/AUTO and depress pb ✓Auto Load Relief ✓HYD BRAKE ISOL VLV (three) – OP
V = 60 KGS	DRAG CHUTE JETT pb – JETT
STOP	Go to ENT C/L, <u>POST LANDING PROCEDURES</u> , 5-1

ENT-6b/E/H

MS ONLY

4-5

ENT/ALL/GEN D,6

td212a_035b

Figure 5-8. Concluded

The navigation-related steps on the Entry Maneuvers cue card are described as follows.

- D = 11 ° DRAG H (FORCE if editing)

Drag altitude (drag H) updating begins when the drag on the vehicle reaches 11 ft/sec² (D = 11). This occurs at an orbiter altitude of approximately 240 kft (range to the runway ±1800 n. mi.) and continues to 85,200 ft altitude or until air data altitude is incorporated (see Figure 5-6). During early shuttle flights, drag H updating would occur during the blackout region of Entry. However, now with TDRS satellites, blackout does not occur. TDRS satellites can become unavailable, so the crewmembers must be prepared to manage drag H without assistance from MCC. SPEC 50 is initialized with DRAG H in AUTO. The crew can monitor the drag value on the Alpha/Mach Indicator (AMI). If the drag H performance is within approximately 8 σ (approximately 80 kft altitude), the drag data pass the Ratio edit criteria (RATIO <1) and can be incorporated into the state vector automatically. If the Ratio ≥1, editing occurs and the crew

procedure is to mode the filter control to FORCE, thus incorporating drag H even though it is outside the edit threshold.

This procedure was adopted because there exists no crew insight as to the cause of the editing; that is, whether the state vector or the drag H data are bad. The drag H data are assumed to be less prone to error than the IMU-propagated state vector. The purpose of drag H is to limit the growth of the state vector errors so that the errors can be corrected with later sensor data, such as TACAN. Therefore, procedurally, drag H is always incorporated unless MCC advises otherwise.

- V = 15k ° NAV AIDS (I/O RESET if required)

This callout at Mach 15 (V = 15k) implies the crew should verify that all navigation sensor units are powered and that the proper channels are selected for TACAN and MLS. If the crew powers up any MLS or air data units, an I/O RESET is required to establish I/O between those units and the GPCs. TACAN units do not require an I/O RESET to establish I/O.

- V = 7k ° TACAN status

By Mach 7 (V = 7k), TACAN lock-on should have occurred. Once the TACAN units are locked on, the crew analyzes the data and coordinates with MCC on the decision to incorporate the TACAN data into navigation.

The TACAN data are displayed to the crew in the lower right corner of SPEC 50 (see Figure 5-7). The TACAN channel of the ground station that TACAN units 1, 2, and 3 are locked onto (or attempting to lock onto) is displayed along with the TACAN azimuth and range data. These data can be displayed in either absolute (ABS) or delta units, as selected by Items 34 or 35. Absolute shows the actual azimuth (bearing in degrees) and range (thousands of feet) from the orbiter to the TACAN ground station, as measured by the onboard TACAN units. Delta shows the differences between what the TACAN units measure and what the navigation software calculates based upon the state vector. Normally the crew uses the deltas on PASS SPEC 50, since the BFS SPEC 50 displays only the absolute values. More information on the TACAN data on SPEC 50 is found in the FDF DPS Dictionary.

The Nav filter data are displayed in the lower left corner of SPEC 50 (Figure 5-7). When the TACAN data and the orbiter state vector are in good agreement, the TAC RATIO (for both AZ and RNG) is small, typically 0 to 0.2. If the Ratio exceeds 0.2, then troubleshooting by the crew should begin to determine whether the large Ratio is caused by a degraded state vector or faulty TACAN data. For example, the crew can “toggle TACAN”; i.e., select the secondary TACAN station via Item 5 on SPEC 50. If the Ratio improves, using the secondary station, then the data from the primary station is suspect. Troubleshooting techniques are discussed in the NAV AIDS 2102 Training Manual.

Normally, MCC is prime for making the decision to incorporate TACAN. Where available, high-speed ground tracking sites provide MCC with an accurate evaluation of the orbiter’s state vector. MCC compares the tracking data with the downlisted orbiter state vector to assess the health of the orbiter state vector. The downlisted data from each TACAN unit are also compared with the tracking data to assess the health of the TACAN data.

When MCC and the crew are satisfied that the TACAN data look good; that is, TACAN is accurate enough to help improve the orbiter state vector through filtering, then MCC makes the ground call to “Take TACAN.” The crew understands that this means to mode TACAN to

AUTO on SPEC 50, via Item 19. The call implies that performance of this action should be made to both PASS and BFS.

In the event that communication is lost with MCC, then the crew is prime for evaluating and incorporating TACAN data. If the decision to incorporate the data is left to the crew, this is referred to as a “crew call.” Where ground tracking is not available, such as at TAL abort sites, MCC does not have a direct means to verify that the TACAN station data are accurate. In this case, MCC relies largely upon the downlisted TACAN and filter (Ratio and Residual) data to assess the health of the TACAN data. In other words, MCC relies largely upon the same information displayed to the crew on SPEC 50. Although MCC insight is limited, due to the increased workload by the crew during aborts, MCC assumes the prime role in making the decision to incorporate TACAN and hence will make the ground call to “Take TACAN.”

The MCC call to “Take TACAN” typically occurs within the orbiter altitudes of 140–160 kft (range to the runway ± 225 –350 n. mi.) (see Figure 5–6). TACAN data (range and bearing) are normally used for filtering until MLS data are incorporated. TACAN bearing is automatically inhibited while the orbiter is in the TACAN cone of confusion, as described in Section 3. While in the cone, the Ratio and Residual for TAC AZ on SPEC 50 will be blank.

- V = 5k ADTA PROBES – DEPLOY (° HEAT)

At Mach 5 (V = 5k), both air data probes are deployed by the crew by taking both air data deploy switches on panel C3 to the DEPLOY position. The ° HEAT portion of the procedure refers to the DEPLOY/HEAT position of the switches. In this position, the probes are deployed and warmed by heaters to help prevent probe icing. The selection of DEPLOY/HEAT is not normally required and is a crew call based upon the weather conditions along the flight path.

The crew can verify that the probes are fully deployed by alternately selecting the right and left probe data to drive the AMI and Altitude Vertical Velocity Indicator (AVVI) tapes. This is done with either of the air data switches on the forward panels. Unless the crew has engaged the BFS, the AMI and AVVI will display OFF flags if the associated probe is not considered deployed by PASS. The details on probe deploy and verification for PASS and BFS are described in the ADS 2102 Training Manual.

The probe ADTAs are calibrated for orbiter speeds below $M = 3.5$. Therefore beginning at $M = 3.5$ the crew and MCC can evaluate the validity of the air data from each of the four ADTAs. The crew analyzes the air data on the SPEC 51 OVERRIDE display, shown in Figure 5–9.

```

XXXX / 051 /          OVERRIDE          XX X DDD / HH : MM : SS
                                   DDD / HH : MM : SS
ABORT MODE          ENTRY FCS
TAL          1X          ELEVON          FILTER          ATMOSPHERE
ATO          2X          AUTO  17X          NOM  20X          NOM    22X
ABORT        3X          FIXED 18X          ALT  21X          N POLE 23X
MAX THROT   4X          SSME REPOS 19 XXX          S POLE 24X
PRPLT DUMP
XXX ICNCT 5 XXXX
OMS DUMP
ARM          6X
START        7X
STOP         8X
9 QUAN / SIDE XXX
OMS DUMP TTG XXX
AFT RCS 13   XXX
14 TIME     XXX
FWD RCS 15   XXX
16 TIME     XXX
IMU STAT ATT DES          PRL
1S XXXX X 25X          SYS AUT DES
2S XXXX XXX 26X          1S 28X 31X
3S XXXX          27X          2S 29X 32X
          3S 30X 33X
ADTA          H          ∞          M          DES
L 1S XXXXXX ± XX.X X.XX 34X
3S XXXXXX ± XX.X X.XX 35X
R 2S XXXXXX ± XX.X X.XX 36X
4S XXXXXX ± XX.X X.XX 37X
ET SEP          ROLL MODE XXXXXXXX
AUTO          38X          AUTO SEL 42X
SEP          39X
ET UMB DR          VENT DOOR CNTL
CLOSE          40X          OPEN 43X XX
RCS RM MANF          CLOSE 44X XX
CL OVRD 41
(X X )

```

td212a_036

Figure 5–9. *OVERVERRIDE display – ADTA data*

The orbiter altitude (H), angle of attack (α), and Mach number (M) measured by each of the four ADTAs are displayed on SPEC 51. To analyze the validity of these air data parameters, the crew can compare them with the navigation software estimate of their values based upon the state vector. These values are displayed on the AMI and AVVI tapes. More information on the air data displayed on SPEC 51 is found in the FDF DPS Dictionary.

The Nav filter information for the air data is displayed on SPEC 50 (see Figure 5–7). The displayed Residual and Ratio are based upon the comparison between the air data baro–altitude (ADTA H) and the navigation software estimate of altitude based upon the state vector. Only baro–altitude is used for state vector filtering. Other air data parameters, such as α and M, are used for guidance and flight control.

Just as for the TACAN data, MCC is prime for making the decision to use the measured air data for navigation and flight control. When MCC and the crew are satisfied that baro–altitude is accurate enough to improve the state vector, and that the other air data parameters are valid for flight control, then MCC makes the ground call to “Take Air Data.” The crew understands that this means to mode ADTA H to AUTO on SPEC 50, via Item 25, and to mode ADTA TO G&C to AUTO, via Item 28 in the PASS. The call also implies to mode ADTA H to AUTO on the BFS SPEC 50 (ADTA TO G&C in the BFS is initialized in AUTO).

If MCC determines that baro–altitude would not improve the state vector, MCC may make the call “Take Air Data to G&C only,” which means to mode ADTA TO G&C to AUTO for flight control but to leave ADTA H in Inhibit on SPEC 50.

Once moded to AUTO, incorporation of baro–altitude by the filter begins at $M = 2.5$ (range to the runway ± 60 n. mi.) and is normally used until MLS is incorporated (see Figure 5–6). There is a gap in baro–altitude usage between $M = 1.6$ and $M = 1.1$, known as the Mach Jump region. Air flow over the probes is unstable in this region; hence the data are not used for state vector filtering.

- If $M < 2.5$, P CSS for ADTA to G&C Incorp
- $M = 2.0$ Ensure ADTA to G&C, else ° THETA limits

These two steps are related to air data for G&C only. Normally the call to incorporate air data to G&C occurs at $M > 2.5$. If, however, the crew incorporates at $M < 2.5$, the crew should manually fly the vehicle in orbiter pitch (Pitch Control Stick Steering, or P CSS) prior to moding ADTA TO G&C to AUTO on SPEC 50. This is to avoid a sudden orbiter pitch transient that may occur if air data supplies a large update to guidance. After air data to G&C are incorporated, the crew may return to AUTO flight control.

In the second step, if air data have still not been incorporated to G&C by $M = 2$, the crew manually flies the orbiter using a technique referred to as “theta limits.” In theta limits, air data parameters for G&C are supplied by the onboard software rather than from the air data probes. In this case, the orbiter pitch angle (theta) must be manually managed by the crew. This is performed by taking P CSS and maintaining the orbiter pitch within nose high and nose low limits on the VERT SIT display. More information on the software–supplied air data and the theta limits technique may be found in the ADS 2102 and Entry Guidance 2102 Training Manuals.

- $h = 15k$ ° MLS

By 15 kft altitude ($h = 15k$), MLS should be locked on. The range to the runway is ± 10 n. mi. No crew actions are required to incorporate MLS for state vector filtering. If the navigation software determines the onboard MLS units are in good health and the correct MLS channel has been selected by the crew, then the software automatically incorporates the MLS data. It is essential that the crew verify that they have selected the correct channel since MCC has no telemetry on this selection. The principal indication to the crew that MLS has been incorporated is that the TACAN and ADTA H RATIO and RESID columns on SPEC 50 become blank, indicating that MLS data have replaced TACAN and air data for state vector filtering. Because MLS is normally highly accurate, its data are heavily weighted by the Kalman filter (see Section 3).

RTLS Navigation

RTLS navigation (OPS 6) works similarly to OPS 3 Entry navigation with the following notes:

- Single–state navigation is used throughout the RTLS abort; one state vector is propagated, instead of three.
- The MCC updates the state vector with delta state vector updates only.
- The MCC performs delta state updates to maintain the state vector more stringently in an RTLS than a nominal Entry.

- TACAN is usually acquired by 220 kft altitude. TACAN management is similar to Entry.
- Air data probe deploy and verification are handled by the crew the same as in a nominal Entry. However, the air data G&C parameters in OPS 6 are not downlisted to the ground. Therefore the crew is prime to assess the quality of G&C parameters by comparing the SPEC 51 air data with the AMI and AVVI tape data. MCC does have insight into baro–altitude. When MCC is satisfied that baro–altitude is accurate, the ground call is made to “Take Air Data to Nav. G&C is crew call.”
- The MLS units are powered off for Ascent. Thus, the crew is required to power on the MLS units at ± 85 kft altitude per procedures and do an I/O RESET to clear the MLS comm fault.

BFS Differences

The following is a summary of the differences between BFS navigation and PASS navigation:

- a. During Entry, the BFS maintains one state vector as it does throughout the flight in contrast to the PASS, which uses a three state vector scheme during Entry Nav.
- b. Preengage, MCC typically uplinks state vector updates to PASS then has the crew update the BFS state vector by performing a PASS–to–BFS SV XFER rather than uplink directly to the BFS. Postengage, any necessary state vector updates are uplinked directly to the BFS.
- c. The ADTA TO G&C filter control on BFS SPEC 50 is initialized in AUTO. This selection is made so that in the event BFS is engaged after the air data have been evaluated, BFS will immediately have air data for G&C to help control the vehicle.
- d. The BFS does not drive OFF flags on the AMI or AVVI. Hence the air data probe deploy and verification by the crew are different from PASS. Refer to the ADS 2102 Workbook for a discussion on air data probe deploy when the BFS is engaged.
- e. BFS does not use MLS. Hence on Entry, BFS will use TACAN down to an orbiter altitude of 1500 ft and will use air data H to 500 ft (see Figure 5–6). Without MLS, the BFS state vector on final approach is generally not as accurate as the PASS state vector with MLS.
- f. BFS has no orbit or rendezvous navigation.

Questions

Answers to the following questions are in Appendix B.

1. What actions must be performed by MCC and the crew before Rendezvous navigation can be enabled?
2. For a nominal Entry, over what ranges in altitude are drag H, TACAN, air data, and MLS data used for state vector aiding?
3. Which procedures do the crew reference for navigation management from EI to landing?
4. Under what conditions would the crew take action on the state vector aiding by drag H?
5. On Entry, what are the crew actions in response to the MCC call to “Take TACAN”?
6. For nominal Entry, when are the air data probes deployed? When does air data evaluation by the crew begin? When are air data used for state vector aiding?
7. On Entry, what are the crew actions in response to the MCC call to “Take Air Data”?
8. What is the indication to the crew that MLS data are incorporated for state vector aiding?
9. What are the differences between OPS 3 Entry and RTLS in the ground calls concerning Nav aid sensors?
10. On Entry, what are the primary differences between PASS and BFS navigation?

Appendix A

Acronyms and Abbreviations

A/I/F	Auto/Inhibit/Force
ADI	Attitude Director Indicator
ADS	Air Data System
ADTA	Air Data Transducer Assembly
AMI	Alpha/Mach Indicator
AOA	Abort Once Around
APU	Auxiliary Power Unit
ATT REF	Attitude Reference
AVVI	Altitude/Vertical Velocity Indicator
AZ	azimuth
BFS	Backup Flight System
c.g.	center of gravity
CBT	Computer Based Training
COAS	Crew Optical Alignment Sight
CRT	Cathode-Ray Tube
CSS	Control Stick Steering
DAP	Digital Autopilot
DEC	Declination
DME	Distance Measurement Equipment
DPS	Data Processing System
EAS	Equivalent Air Speed
EI	Entry Interface
EL	elevation
FCS	Flight Control System
FDF	Flight Data File
FF	Flight Forward
FLTR	Filter
FOV	Field of View
FRL	Fuselage Reference Line
ft/s	feet per second
G&C	Guidance and Control
GNC	Guidance, Navigation, and Control
GPC	General Purpose Computer
GPS	Global Positioning System

H	altitude
HSD	Horizontal Situation Display
HSI	Horizontal Situation Indicator
HUD	Head Up Display
I-load	initial load
I/O	Input/Output
IDS	Integrated Documentation Services
IMU	Inertial Measurement Unit
JSC	Lyndon B. Johnson Space Center
kft	thousand feet
LOS	Line of Sight
LVLH	Local Vertical/Local Horizontal
M	Mach
M50	Mean of 1950
MCC	Mission Control Center
MECO	Main Engine Cutoff
MLS	Microwave Landing System
MM	Major Mode
MMU	Mass Memory Unit
MOD	Mission Operations Directorate
MSBLS	Microwave Scanning Beam Landing System
MVS	Mid-Value Select
NASA	National Aeronautics and Space Administration
Nav	Navigation
NAV aid	Navigation aid
n. mi.	nautical mile
OMS	Orbital Maneuvering System
OPS	Operational Sequence
PASS	Primary Avionics Software System
P CSS	Pitch Control Stick Steering
PRI	Primary
PROP	Propagation
Prox Ops	Proximity Operations
\bar{q}	dynamic pressure

RA	Right Ascension Radar Altimeter
RCS	Reaction Control System
RESID	Residual
RM	Redundancy Management
RNDZ	Rendezvous
RNG	range
RNP	Rotation, Nutation, Precession
RR	Rendezvous Radar
RRM	RELMAT Relative Matrix
RTLS	Return to Launch Site
RWY	Runway
SEC	Secondary
SM	Systems Management
SPEC	Specialist Function
ST	Star Tracker
TACAN	Tactical Air Navigation
TACANS	Tactical Air Navigation System
TAL	Transoceanic Abort Landing
TAMS	Training Administration Management System
TAS	True Air Speed
TDRS	Tracking and Data Relay Satellite
UPP	User Parameter Processing
VEL	Velocity
V _{REL}	Relative Velocity
Δ	angle of attack

Appendix B

Answers

Answers to Section 1

1. The orbiter state vector is calculated in the M50 coordinate system. M50 is used because it is an inertial coordinate system. An inertial coordinate system is required because the state vector is calculated using Newton's laws of motion, which are valid only in an inertial coordinate system.
2. The origin of the shuttle body axes is the orbiter center of mass. The +X axis points out the nose of the orbiter; the +Y axis points out the starboard wing; and the +Z points out the belly.
3. The LVLH coordinate system is a rotating coordinate system with the origin at the center of mass of the orbiter. The +Z axis points towards the center of the Earth along the radius vector. The +Y axis points in a southerly direction towards the negative angular momentum vector of the vehicle's orbit. The +X axis completes the right-handed orthogonal system.
4. The origin of the M50 coordinate system is the center of the Earth. The axes are referenced to the Earth's orientation in the year 1950. The +Z axis for M50 points out the North Pole of the Earth. The X and Y axes are in the plane of the Earth's Equator. The +X axis points at the vernal equinox. The +Y axis completes the right-handed orthogonal system.
5. The Starball coordinate system is useful because as crewmembers read the Starball pitch and yaw angles off the ADI, they directly read the right ascension and declination pointed to by the orbiter's +X axis.
6. The RNP matrix is the transformation matrix used in coordinate transformations between the M50 and the Earth-Fixed coordinate systems, for applications that require accurate reference to the Earth.

Answers to Section 2

1. The purpose of the IMU accelerometers is to sense vehicle accelerations and output the acceleration data for use by the navigation software for state vector propagation.
2. The purpose of the Super-G Navigation software is to calculate the onboard state vector once per Nav cycle, using classical equations of motion. The inputs to Super-G Nav are the acceleration data from the IMUs and software model data from the onboard gravity, drag, and vent models.
3. The navigation software requires the use of a gravity model for state vector propagation because vehicle acceleration due to the force of gravity affects the orbiter state vector; however, the IMUs are unable to sense gravitational accelerations.
4. The detailed gravity model (fourth order) is always used on orbit in OPS 2 and OPS 8; it is used during Entry or Ascent (OPS 1, 3, and 6) only when the IMU-sensed accelerations are

below a predefined threshold. The simplified gravity model (second order) is otherwise used in OPS 1, 3, and 6.

5. Navigation software uses modeled drag acceleration instead of IMU-sensed drag acceleration whenever the IMU-sensed acceleration is below a predefined threshold.
6. In the single state vector scheme, acceleration data from the three IMUs are input to an RM selection filter, which selects a single set of acceleration data (three vector components). The selected acceleration data are input to Super-G Nav, which calculates a single state vector. When external sensor data are available for state vector aiding, the Super-G Nav state vector is input to a Kalman filter. The final output of the single state vector scheme is the User state vector. The single state vector scheme is used in all phases of flight in PASS, except for OPS 3 Entry navigation, and all BFS flight phases.
7. In the three state vector scheme, acceleration data from the three IMUs are input to Super-G Nav, which calculates three separate state vectors, one for each IMU. The Super-G Nav state vectors are input to a Kalman filter for state vector aiding, when external sensor data are available to the filter. The three filtered states are then reduced to a single User state vector by an RM vector selector. The three state vector scheme is used in PASS OPS 3 Entry navigation only.
8. The onboard navigation software calculates a new User state vector once per Nav cycle. In all phases of flight, except Pre-land navigation, a Nav cycle is 3.84 seconds. In Pre-land navigation, a Nav cycle is 3.84 seconds ± 2 , or 1.92 seconds.
9. The three state vector scheme is designed to protect for multiple IMU failure scenarios (as few as two).

Answers to Section 3

1. The parameters that are supplied to the Kalman filter by the navigation aids are as follows:
 - a. Drag H – Derived orbiter altitude
 - b. TACANS – Bearing and slant range to the TACAN station
 - c. ADS – Baro-altitude of the orbiter
 - d. MLS – Slant range, azimuth, and elevation of the orbiter to the runway
2. The navigation sensors available for state vector filtering during Rendezvous navigation are the Star Trackers, COAS, and Rendezvous Radar.
3. The Residual for a given sensor parameter is defined as the difference between the value of the parameter as measured by the sensor and the value of the parameter as computed from the onboard state vector.
4. The Ratio for a given sensor parameter is defined as the Residual for that parameter divided by the maximum Residual allowed by the navigation software.
5. The Kalman filter updates the state vector with a sensor measurement by multiplying the measurement Residual with the Kalman gain to form the Kalman update factor. The Kal-

man update factor is then added to the state vector. This process is known as Kalman filter updating; it occurs once per Nav cycle for each sensor parameter processed by the filter.

6. The covariance matrix is a 6 × 6 matrix whose diagonal elements are the variances of the six state vector components. The off-diagonal terms are the cross-correlation terms. One can conceptualize the covariance matrix as describing a volume in position and velocity space that contains the orbiter, within a degree of uncertainty.
7. The term “open” covariance matrix means that the elements of the matrix are at their maximum values (the volume of uncertainty around the orbiter is large). The term “shrinking” covariance matrix means that the matrix elements are decreasing to small values (the volume of uncertainty is decreasing). When the covariance matrix is open, the Kalman gain is maximized, leading to larger update factors than when the covariance matrix has shrunk.
8. The greatest sensor weight for Kalman filtering during Entry is given to the MLS sensors. The least weight is given to drag H.
9. The filter control AUT on SPEC 50 allows the Kalman filter to update the state vector with the sensor data (we say the data are “incorporated” into navigation), providing the data are available to the filter and providing the data pass the Ratio Edit Test. INH inhibits the sensor data from updating the state vector. FOR forces the sensor data to be incorporated, regardless of the status of Ratio Edit Test.

Answers to Section 4

1. A whole state vector update is an uplink by MCC to the orbiter of a whole, new User state vector to replace the existing onboard User state vector. It is performed during the orbit phase of flight, as needed, to maintain the accuracy of the onboard state vector within flight rule limits.
2. A delta state vector update is an uplink by MCC to the orbiter of corrections to the User state vector by way of adding or subtracting “deltas” to the User state vector components. The deltas are defined as the differences between the onboard User state and the MCC-computed state. Delta updates are typically performed during dynamic phases of flight, as needed, to maintain the accuracy of the onboard state vector within flight rule limits.
3. A voice delta state vector update is a correction to the User state vector that is manually performed by the crew, whereby MCC “voices” the deltas to the crew. The crew inputs and loads the deltas via Item entry to SPEC 50. This procedure is performed only in the event that uplink capability to the orbiter has been lost, while voice contact between MCC and the crew has been maintained.
4. A zero delta state vector update, or “Nav delta zero,” is essentially a delta state vector update where the deltas to the User state vector are all equal to zero. It is manually performed by the crew via Item entry to SPEC 50. A Nav delta zero is done in OPS 3 Entry navigation only and is used in procedures to recover from certain failures, such as a commfaulted IMU.
5. A PASS state vector is transferred to the BFS when the crew manually performs a PASS-to-BFS state vector transfer via Item entry on BFS SPEC 50, or whenever the BFS software is moded from OPS 0 to OPS 3.

Answers to Section 5

1. To enable Rendezvous navigation, MCC must uplink a target state vector to the orbiter followed by the crew execution of an Item entry (Item 1) to GNC SPEC 33.
2. The typical range of altitude that drag H is used for state vector aiding is between approximately 240 kft and 85 kft. TACAN, air data, and MLS are typically used over the approximate ranges of 140–18 kft, 85–18 kft, and 18–0 kft, respectively.
3. From EI to landing, the crew references the Entry Maneuvers cue card procedures for navigation management.
4. The crew takes action on the state vector aiding by drag H if the observed drag H Ratio on SPEC 50 is ≥ 1 . In this case, the crew would mode the drag H filter control to FORCE on SPEC 50 to bypass the Ratio editing.
5. In response to the MCC call to “Take TACAN,” the crew would mode the TACAN filter control from INHIBIT to AUTO on PASS and BFS SPEC 50.
6. For a nominal Entry, the air data probes are deployed at Mach 5. Air data evaluation by the crew begins at Mach 3.5. The use of air data for state vector aiding starts when the ADTA H filter control is moded by the crew to AUTO on SPEC 50 and Mach ≤ 2.5 .
7. In response to the MCC call to “Take Air Data,” the crew would mode the ADTA H filter control from INHIBIT to AUTO on PASS and BFS SPEC 50, and mode the ADTA TO G&C filter control to AUTO in PASS only.
8. The indication to the crew that MLS data are incorporated for state vector aiding is the blanking of the PASS SPEC 50 Ratio and Residual columns for TACAN and ADTA H. This indicates that MLS has replaced TACAN and air data for state vector aiding.
9. In OPS 3 Entry, nominally MCC is prime to make the decision on incorporation of sensor data, based upon the downlist evaluation. In RTLS, the air data G&C data are not down-listed; hence, the crew is prime to make the decision on the use of air data for G&C. This is reflected by the MCC call that “G&C is crew call.”
10. On Entry, the BFS uses the single state vector scheme versus the PASS three state scheme. In addition, the BFS does not use MLS for state vector aiding.