

RECEIVED

JSC-07896

Volume **IV**

Revision 2

AUG 11 1975

*N. E. Sears*  
R. H. BATTIN

**JSC INTERNAL NOTE NO. 73-FM-47**

**July 28, 1975**

**SPACE SHUTTLE SYSTEM  
BASELINE REFERENCE MISSIONS  
VOLUME **IV** - MISSION 3B  
REVISION 2**

(This document supersedes JSC Internal Note No. 73-FM-47,  
revision 1, dated May 7, 1974.)



**Mission Integration Branch  
MISSION PLANNING AND ANALYSIS DIVISION  
*National Aeronautics and Space Administration*  
**LYNDON B. JOHNSON SPACE CENTER**  
*Houston, Texas***

JSC-07896  
Volume IV  
Revision 2

JSC INTERNAL NOTE NO. 73-FM-47

---

SHUTTLE PROGRAM  
SPACE SHUTTLE SYSTEM  
BASELINE REFERENCE MISSIONS  
VOLUME IV - MISSION 3B  
REVISION 2

By Mission Planning and Analysis Division

---

July 28, 1975

MISSION PLANNING AND ANALYSIS DIVISION  
NATIONAL AERONAUTICS AND SPACE ADMINISTRATION  
JOHNSON SPACE CENTER  
HOUSTON, TEXAS

Approved: 

James J. Taylor, Assistant Chief  
Mission Integration Branch

Approved: 

Ronald L. Berry, Acting Chief  
Mission Planning and Analysis Division



## ACKNOWLEDGMENTS

The following individuals have contributed to this document.

Initialization data	Larry D. Davis
Ascent	Sam A. Kamen
ET disposal	Joe W. Nolley
Orbiter/ET separation	Robert E. Prah
Orbiter/ET separation	Robert E. McAdams
Onorbit trajectory, rendezvous	Roger H. Sanders
Rendezvous ground rules and constraints	Allan L. DuPont
Deorbit/entry/land	Morris V. Jenkins
Deorbit	Benjamin J. Garland Dallas G. Ives
Entry	Claude A. Graves Jon C. Harpold David W. Heath
TAEM and autoland	Willis M. Bolt James V. West Gilbert L. Carman William C. Lamey
Attitude time line	David S. Scheffman
Propulsive consumables	Don A. Nelson
Nonpropulsive consumables	Cynthia D. Wells
Manipulator time line	Louis E. Livingston Spacecraft Design Division
Navigation	Flora B. Lowes

# CONTENTS

Section		Page
1.0	<u>SUMMARY</u> . . . . .	1
2.0	<u>INTRODUCTION</u> . . . . .	5
3.0	<u>SYMBOLS AND TERMS</u> . . . . .	7
4.0	<u>MISSION DESCRIPTION</u> . . . . .	9
4.1	ASCENT . . . . .	12
4.1.1	Lift-Off through Transfer Orbit Insertion . . . . .	12
4.1.1.1	Ascent trajectory design, guidance, and targeting . . . . .	12
4.1.1.1.1	Trajectory design . . . . .	12
4.1.1.1.2	Guidance: SRB staging to MECO . . . . .	12
4.1.1.1.3	Guidance: MECO to orbit insertion . . . . .	13
4.1.1.1.4	Targeting . . . . .	13
4.1.1.2	Nominal ascent trajectory . . . . .	13
4.1.1.2.1	Booster phase . . . . .	13
4.1.1.2.2	Orbiter/ET guided phase . . . . .	14
4.1.1.2.3	Orbiter/ET separation sequence. . . . .	15
4.1.1.2.4	OMS burn to insertion . . . . .	15
4.1.2	External Tank Disposal . . . . .	40
4.1.2.1	External tank disposal summary . . . . .	40
4.1.2.2	Time line . . . . .	40
4.1.2.3	Impact location . . . . .	40
4.1.2.4	Dispersion analysis . . . . .	40
4.2	ONORBIT ACTIVITIES . . . . .	44
4.2.1	3B Rendezvous . . . . .	44
4.2.1.1	Nominal rendezvous profile . . . . .	44
4.2.1.2	Nominal rendezvous time line . . . . .	44
4.2.2	Payload Retrieval . . . . .	52
4.2.2.1	Ground rules, guidelines, and assumptions . . . . .	52
4.2.2.2	Payload retrieval activities . . . . .	52

Section	Page
4.3 DESCENT . . . . .	55
4.3.1 Deorbit . . . . .	55
4.3.2 Entry Interface Targeting . . . . .	56
4.3.3 Entry Trajectory . . . . .	58
4.3.4 Terminal Flight . . . . .	58
5.0 <u>MISSION EVALUATION</u> . . . . .	99
5.1 ASCENT . . . . .	99
5.2 ONORBIT . . . . .	99
5.3 DEORBIT AND ENTRY . . . . .	99
5.4 COMPLIANCE WITH LEVEL I REQUIREMENTS . . . . .	100
APPENDIX A - SHUTTLE BRM 3B 3ROUND RULES AND CONSTRAINTS . . . . .	101
A1.0 <u>ASCENT</u> . . . . .	103
A2.0 <u>EXTERNAL TANK DISPOSAL</u> . . . . .	105
A3.0 <u>ORBITER/ET NOMINAL AND AOA SEPARATION</u> . . . . .	106
A4.0 <u>ORBITAL OPERATIONS</u> . . . . .	108
A5.0 <u>DEORBIT AND ENTRY</u> . . . . .	109
A5.1 DEORBIT . . . . .	109
A5.2 ENTRY THROUGH TOUCHDOWN . . . . .	110
A6.0 <u>OMS MANEUVERS</u> . . . . .	111
A7.0 <u>RCS MANEUVERS</u> . . . . .	112
A8.0 <u>EPS AND ECLSS</u> . . . . .	113
A9.0 <u>ATTITUDE AND POINTING</u> . . . . .	114
A9.1 GENERAL . . . . .	114
A9.2 GN&C FCS . . . . .	116
A9.3 ET SEPARATION . . . . .	117
A9.4 PAYLOAD OPERATIONS . . . . .	118
A10.0 <u>RENDEZVOUS</u> . . . . .	119
APPENDIX B - INPUT DATA . . . . .	121
APPENDIX C - CONSUMABLES SUMMARY . . . . .	141
APPENDIX D - MANIPULATOR TIME LINE FOR RETRIEVAL . . . . .	155
APPENDIX E - TABULAR TRAJECTORY DATA . . . . .	161
REFERENCES . . . . .	164

TABLES

Table	Page
4-I SHUTTLE BRM 3B SEQUENCE OF EVENTS . . . . .	10
4.1.2.1-I EXTERNAL TANK DISPERSION FOR SHUTTLE BRM 3B . . . . .	42
4.2-I ASSUMED BRAKING GATES FOR SHUTTLE BRM 3B RENDEZVOUS . . . . .	46
4.3-I ERASABLE MEMORY LOAD FOR SHUTTLE BRM 3B ENTRY GUIDANCE . . . . .	61
4.3-II SUMMARY OF SHUTTLE BRM 3B ENTRY TRAJECTORY EVENTS . . . . .	63
4.3-III THERMAL PROTECTION SYSTEM (TPS) SUMMARY FOR SHUTTLE BRM 3B . . . . .	64
A-I ORBITER/ET NOMINAL AND AOA SEPARATION MANEUVER TIME LINE . . . . .	107
B-I MECO TARGETS FOR SHUTTLE BRM 3B . . . . .	123
B-II MASS PROPERTIES SUMMARY FOR SHUTTLE BRM 3B . . . . .	124
B-III SHUTTLE WEIGHT SUMMARY FOR SHUTTLE BRM 3B . . . . .	126
B-IV ATMOSPHERE MODELS FOR SHUTTLE BRM 3B . . . . .	127
B-V ASCENT PROPELLANT SUMMARY FOR SHUTTLE BRM 3B . . . . .	128
B-VI PROPULSION SUMMARY FOR SHUTTLE BRM 3B . . . . .	129
B-VII LAUNCH AND LANDING SITE COORDINATES . . . . .	138
B-VIII AERODYNAMICS . . . . .	139
C-I OMS AND RCS LOADINGS FOR SHUTTLE BRM 3B . . . . .	143
C-II SHUTTLE BRM 3B PROPELLANT BUDGET . . . . .	144
C-III APU FUEL AND WATER SUMMARY FOR SHUTTLE BRM 3B . . . . .	148
C-IV ECLSS CONSUMABLES SUMMARY FOR SHUTTLE BRM 3B . . . . .	149
C-V EPS SUBSYSTEM SUMMARY FOR SHUTTLE BRM 3B . . . . .	151
C-VI SHUTTLE BRM 3B CRYOGENIC SUMMARY . . . . .	152
D-I RETRIEVAL SEQUENCE OF EVENTS . . . . .	159
E-I TRAJECTORY START VECTORS FOR SHUTTLE BRM 3B . . . . .	163

## FIGURES

Figure		Page
1-1	Shuttle BRM 3B attitude time line . . . . .	3
1-2	Shuttle BRM 3B groundtrack . . . . .	4
4-1	Geometrical sketch of shuttle BRM 3B . . . . .	11
4.1.1-1	Atmospheric thrust versus ground elapsed time for shuttle BRM 3B . . . . .	17
4.1.1-2	Dynamic pressure versus ground elapsed time for shuttle BRM 3B . . . . .	18
4.1.1-3	Sensed acceleration versus ground elapsed time for shuttle BRM 3B . . . . .	19
4.1.1-4	Inner gimbal angle versus ground elapsed time for shuttle BRM 3B . . . . .	20
4.1.1-5	Middle gimbal angle versus ground elapsed time for shuttle BRM 3B . . . . .	21
4.1.1-6	Outer gimbal angle versus ground elapsed time for shuttle BRM 3B . . . . .	22
4.1.1-7	Vehicle local-horizontal pitch attitude versus ground elapsed time for shuttle BRM 3B. . . . .	23
4.1.1-8	Vehicle out-of-plane yaw attitude versus ground elapsed time for shuttle BRM 3B . . . . .	24
4.1.1-9	Local-horizontal roll attitude versus ground elapsed time for shuttle BRM 3B . . . . .	25
4.1.1-10	Main-engine atmospheric thrust versus ground elapsed time for shuttle BRM 3B . . . . .	26
4.1.1-11	Commanded pitch attitude versus ground elapsed time for shuttle BRM 3B . . . . .	27
4.1.1-12	Commanded yaw attitude versus ground elapsed time for shuttle BRM 3B . . . . .	28
4.1.1-13	Time-to-go versus ground elapsed time for first guidance maneuver for shuttle BRM 3B . . . . .	29
4.1.1-14	Main-engine throttle setting versus ground elapsed time for shuttle BRM 3B . . . . .	30
4.1.1-15	Altitude versus surface range for shuttle BRM 3B . . . . .	31
4.1.1-16	Relative motion for orbiter/ET nominal and AOA separation maneuver . . . . .	32

Figure	Page
4.1.1-17	Time-to-go versus ground elapsed time for second guidance maneuver for shuttle BRM 3B . . . . . 33
4.1.1-18	Inertial velocity versus ground elapsed time for shuttle BRM 3B . . . . . 34
4.1.1-19	Inertial flightpath angle versus ground elapsed time for shuttle BRM 3B . . . . . 35
4.1.1-20	Altitude versus ground elapsed time for shuttle BRM 3B. 36
4.1.1-21	Mach number versus ground elapsed time for shuttle BRM 3B . . . . . 37
4.1.1-22	Pitch angle-of-attack versus ground elapsed time for shuttle BRM 3B . . . . . 38
4.1.1-23	Axial force versus ground elapsed time for shuttle BRM 3B . . . . . 39
4.1.2-1	Shuttle BRM 3B ET impact and dispersion area . . . . . 43
4.2.1-1	Selection criteria for establishment of the shuttle BRM 3B insertion targets . . . . . 47
4.2.1-2	Relative motion between the orbiter and payload in a payload-centered curvilinear coordinate system for a nominal shuttle BRM 3B . . . . . 48
4.2.1-3	Shuttle BRM 3B nominal RCS thrusting during braking . . 49
4.2.1-4	Range rate versus range profile during braking phase of shuttle BRM 3B . . . . . 50
4.2.1-5	Time history of nominal relative parameters between orbiter and payload for shuttle BRM 3B satellite retrieval . . . . . 51
4.2.2-1	Geometry for shuttle BRM 3B satellite retrieval . . . . . 53
4.2.2-2	Time line for mission 3B satellite retrieval . . . . . 54
4.3-1	Surface temperature critical control points and various panel locations for the shuttle orbiter . . . 65
4.3-2	Maximum nose control point surface temperature versus inertial flightpath angles for various entry ranges for shuttle BRM 3B . . . . . 66
4.3-3	Total heat load and altitude versus inertial flightpath angle for various entry ranges from 400 000 feet for shuttle BRM 3B . . . . . 67
4.3-4	Inertial velocity, inertial flightpath angle, and range target lines for shuttle BRM 3B . . . . . 68

Figure		Page
4.3-5	Elevon, body flap, and speed brake deflection versus relative velocity for shuttle BRM 3B . . . . .	69
4.3-6	Shuttle BRM 3B groundtrack from entry interface to landing . . . . .	70
4.3-7	Altitude, altitude rate, relative velocity, and mach number versus time from entry interface for shuttle BRM 3B . . . . .	71
4.3-8	Angle of attack, local-horizontal pitch angle, and Earth-relative flightpath angle versus time from entry interface for shuttle BRM 3B . . . . .	72
4.3-9	Bank and heading angles versus time from entry interface for shuttle BRM 3B . . . . .	73
4.3-10	Control point surface temperatures for shuttle BRM 3B . . . . .	74
4.3-11	Reference heat rate versus time from entry interface for shuttle BRM 3B . . . . .	76
4.3-12	Altitude and altitude rate versus relative velocity for shuttle BRM 3B . . . . .	77
4.3-13	Dynamic pressure and total load factor versus relative velocity for shuttle BRM 3B . . . . .	78
4.3-14	Angle of attack, lift/drag, and Earth-relative flightpath angle versus relative velocity for shuttle BRM 3B . . . . .	79
4.3-15	Actual and reference drag acceleration versus relative velocity for shuttle BRM 3B . . . . .	80
4.3-16	Elevon, speed brake, and body flap hinge moments versus time from entry interface for shuttle BRM 3B . . . . .	81
4.3-17	Elevon, speed brake, and body flap hinge moments versus relative velocity for shuttle BRM 3B . . . . .	82
4.3-18	Altitude, altitude rate, and relative velocity versus entry target range for shuttle BRM 3B . . . . .	83
4.3-19	Reference heat rate versus relative velocity for shuttle BRM 3B . . . . .	84
4.3-20	Terminal area groundtrack for shuttle BRM 3B . . . . .	85
4.3-21	Altitude, altitude rate, and relative velocity versus time from entry interface for shuttle BRM 3B . . . . .	86
4.3-22	Angle of attack, local-horizontal pitch angle, and Earth-relative flightpath angle versus time from entry interface for shuttle BRM 3B . . . . .	87

Figure	Page
4.3.23 Bank and heading angles versus time from entry interface for shuttle BRM 3B . . . . .	88
4.3-24 Elevon, body flap, and speed brake deflection versus time from entry interface for shuttle BRM 3B . . . . .	89
4.3-25 Elevon, speed brake, and body flap hinge moments versus time from entry interface for shuttle BRM 3B . . . . .	90
4.3-26 Total load factor and dynamic pressure versus time from entry interface for shuttle BRM 3B . . . . .	91
4.3-27 Altitude and altitude rate versus relative velocity for shuttle BRM 3B . . . . .	92
4.3-28 Energy/weight versus range-to-go for shuttle BRM 3B . . . . .	93
4.3-29 True airspeed, equivalent airspeed, and mach number versus time from entry interface for shuttle BRM 3B . . . . .	94
4.3-30 Orbiter to threshold azimuth and elevation angles versus time from entry interface for shuttle BRM 3B . . . . .	95
4.3-31 Azimuth, elevation, and line-of-sight range to orbiter versus time from entry interface for shuttle BRM 3B . . . . .	96
4.3-32 Altitude, altitude rate, relative velocity, and range to threshold versus time to touchdown for shuttle BRM 3B . . . . .	97
4.3-33 Ground-level-sonic-boom-overpressure contours for shuttle BRM 3B . . . . .	98
B-1 Solid rocket booster atmospheric thrust versus ground elapsed time for shuttle BRM 3B . . . . .	140
C-1 Consumables-related sequence of events for shuttle BRM 3B . . . . .	147
C-2 Potable water on board for shuttle BRM 3B . . . . .	150
C-3 Total oxygen quantity remaining for shuttle BRM 3B . . . . .	153
C-4 Total hydrogen quantity remaining for shuttle BRM 3B . . . . .	154



# SPACE SHUTTLE SYSTEM BASELINE REFERENCE MISSIONS

## VOLUME IV - MISSION 3B

### REVISION 2

By Mission Planning and Analysis Division

#### 1.0 SUMMARY

This volume, the fourth of a four-volume document defining the reference missions for the space shuttle system, describes mission 3B - a one-revolution, satellite-retrieval mission - of the shuttle baseline reference missions. Volume IV includes detailed trajectory, attitude, and vehicle performance data for all mission phases from lift-off through landing. In addition to the nominal mission 3B trajectory data presented, other results included are detailed attitude time lines for the orbiter from insertion to deorbit (fig. 1-1), a groundtrack (fig. 1-2), and satellite retrieval operations. The North American Rockwell MCR-500 orbiter configuration and the associated total vehicle weights presented in the Rockwell International Space Shuttle Mass Properties Status Report (see app. A) are assumed.

The reference mission 3B profile is designed according to the level II reference mission description and performance data for the 150 000-pound orbiter and the 146-inch solid rocket booster (SRB) configuration. In particular, the ascent-to-orbit performance is designed so that the space shuttle main engine (SSME) cutoff is targeted for suborbital external tank jettison conditions and so that a direct ascent rendezvous may be achieved.

Mission 3B is launched from the Western Test Range on a launch azimuth of 198.6 degrees. An assumed 2500-pound payload is included. Prior to lift-off, the satellite to be retrieved will have been maneuvered so that its orbit is compatible with a direct ascent rendezvous. During the boost phase, after SSME cutoff, at a 91.7-nautical-mile altitude, suborbital jettison of the external tank (ET) occurs. The OMS engines are then ignited for orbit insertion, and at insertion cutoff, the orbiter is at an altitude of 90.9 nautical miles, in an orbit of 102 by 85.5 nautical miles. The orbiter is in position to begin the terminal phase rendezvous maneuver with the satellite.

All rendezvous maneuvers are performed manually with the RCS by controlling relative range, range rate, and inertial angular rate between the satellite target and the orbiter according to a prescribed schedule. The orbiter achieves a position of 100 feet from the satellite at the end of the rendezvous phase, maneuvers to retrieval position, and retrieves the satellite. The payload bay doors are closed, and the orbiter is prepared for deorbit.

The deorbit maneuver is performed with two OMS engines and is targeted for entry interface at a 400 000-foot altitude. An additional requirement

on the deorbit maneuver is that sufficient OMS propellant is consumed to result in the appropriate center-of-gravity position following the burn. This is accomplished by a slightly out-of-plane targeting, which has the added benefit of a small reduction in entry crossrange. There are no propulsive events following the deorbit maneuver cutoff.

The entry phase begins at an altitude of 400 000 feet. The entry flight mode consists of flying a 40-degree angle of attack to mach 23.8, followed by a ramping down to a 30-degree angle of attack at mach 17.2, which is then held constant to mach 8. Transition to a low angle of attack to satisfy terminal area landing phase conditions occurs between mach 8 and mach 1.5.

The terminal area phase begins at an altitude of 68 000 feet and is a controlled guidance phase designed for efficient utilization and dissipation of energy within the vicinity of the airfield, establishment of a heading along the runway on a predetermined glide slope, establishment of a flare to accommodate final dispersions, and touchdown and braking to a stop on the runway.

Mission 3B fulfills the level II mission requirements of a single-revolution retrieval of a satellite (orbiter down payload of 25 000 pounds), deorbit and landing occurring on the first revolution, and an orbital translational delta-V limit of 425 fps for the OMS and 190 fps for the RCS.

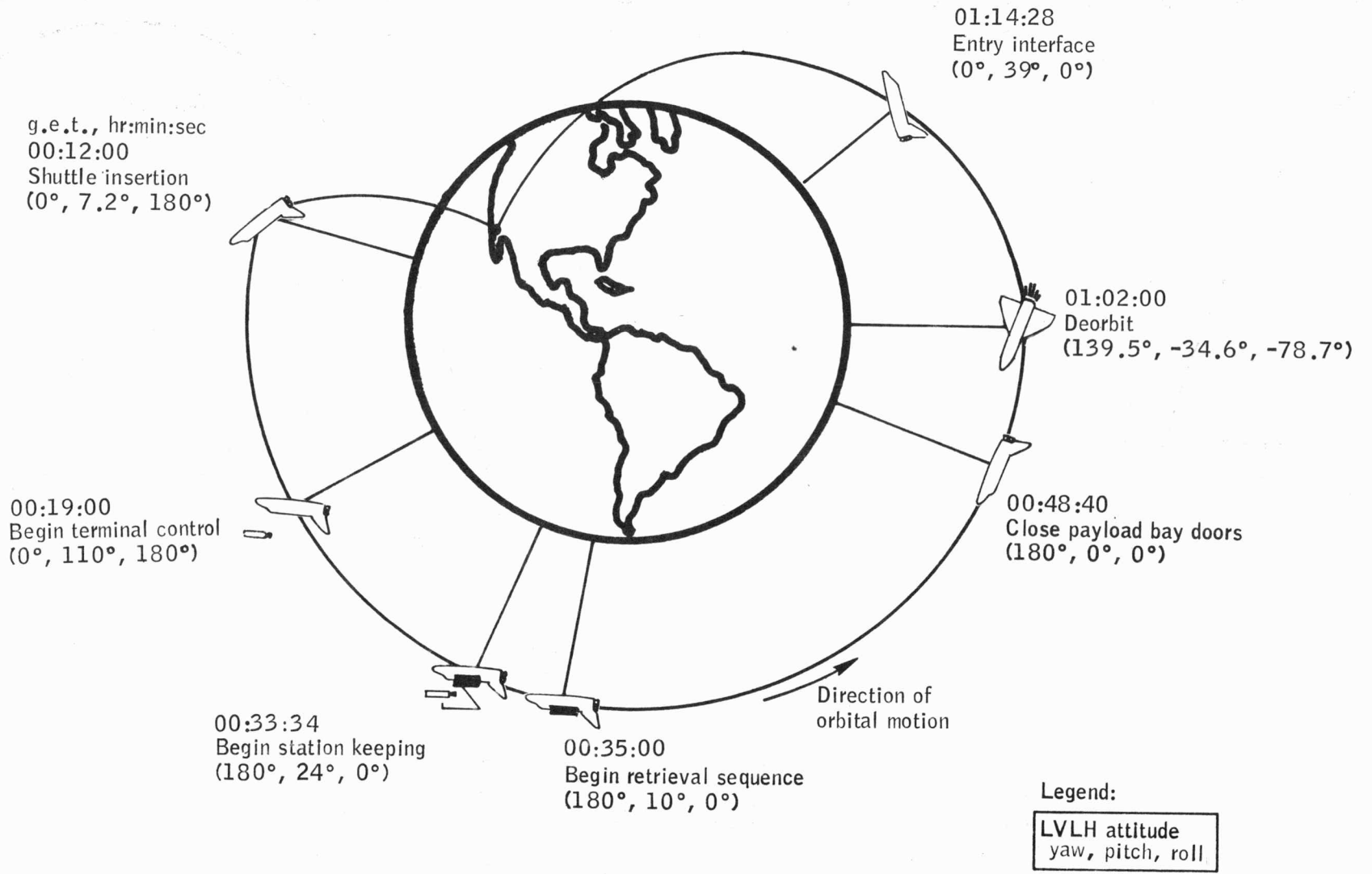

Figure 1-1.- Shuttle BRM 3B attitude time line.

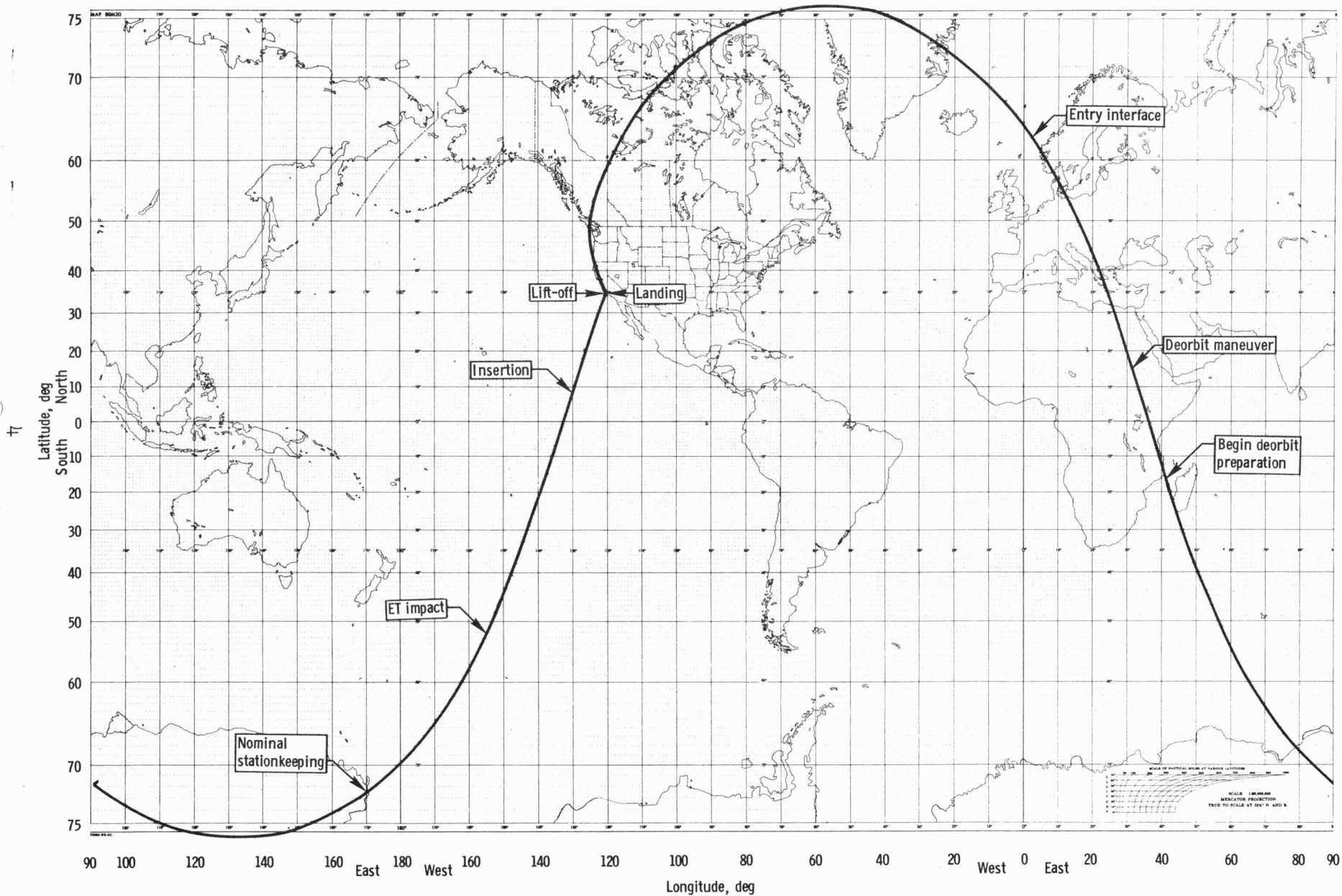

Figure 1-2. - Shuttle BRM 3B groundtrack.

## 2.0 INTRODUCTION

Since the shuttle is to be a workhorse vehicle capable of performing a wide range of Earth orbit operations, no single reference mission exists by which to define the total design requirements for the shuttle; on the contrary, the space shuttle must be designed to perform several types of missions.

The level II Space Shuttle Program requirements define three baseline reference missions. The three reference missions are designated as follows: reference mission 1 - a geosynchronous satellite placement and retrieval mission; reference mission 2 - an orbiting element resupply and sortie mission; and mission 3, which comprises two missions - missions 3A and 3B. Mission 3A is a one-revolution satellite deployment, and mission 3B defines a one-revolution satellite retrieval. These reference missions, which are designed to achieve program objectives, illustrate current shuttle operational functions, techniques, and philosophy. They serve as an operations baseline against which the vehicle design capability can be measured. The detailed mission data they provide can be used to derive vehicle design requirements and operating environments; however, these data are subject to modification as the vehicle design and operational techniques change. The reference missions are not intended to define the design envelope for shuttle operations, since operations are not normally performed at the extremes of system performance. The design envelopes must be determined on the basis of program requirements and mission functions.

The Mission Planning and Analysis Division (MPAD), with cooperation from the Crew Training and Procedures Division (CTPD) and the Spacecraft Design Division (SDD), has begun an effort to design and analyze the baseline missions. The purpose of this effort is to establish requirements for shuttle hardware, software, and operations. As a result, a four-volume document has been issued to describe the reference missions as currently defined. All mission phases are updated in this revision 2 to reflect the latest vehicle performance. Mission 1, the geosynchronous satellite placement mission, is updated in volume I; mission 2, the orbital element resupply and sortie mission, is updated in volume II; mission 3A, the one-revolution payload deployment mission, is updated in volume III; and mission 3B, the one-revolution payload retrieval mission, is updated in volume IV. The separate documentation of missions 3A and 3B, volumes III and IV, is a departure from previous practice, in which both missions were documented in volume III.

Each volume contains a summary of the nominal mission profile, including events time line, attitude profile, crew activities (where applicable), and delta velocity requirements; a detailed analysis of each mission phase, including pertinent trajectory data and mission design philosophy; and a discussion of unresolved problem areas and open items (i.e., a mission evaluation). The appendix of each volume includes the guidelines/constraints/assumptions used to generate the mission, in addition to the space shuttle configuration, aerodynamic data, and engine performance characteristics. "Start vectors" are also provided in the appendix at significant events during the mission so that additional mission phase analysis is possible without regenerating the entire trajectory up to the beginning of that phase. The appendix of each volume includes other detailed data as appropriate.

Requests for additional or more detailed information on these missions should be addressed to the Mission Integration Branch (FM2) or the Data Management Office (FM13) at the Johnson Space Center.

### 3.0 SYMBOLS AND TERMS

AOA	abort once-around
braking	final rendezvous intercept phase consisting of successive maneuvers to null the relative motion
BRM	baseline reference mission
CD	drag coefficient
c.g.	center of gravity
coelliptic $\Delta h$	constant height difference between orbits
CTPD	Crew Training and Procedures Division
DME	distance measuring equipment
duty cycle	burn durations and time between burns
EAS	equivalent air speed
EI	entry interface
elevation angle	angle between local horizontal and line-of-sight to target
EPL	emergency power level
ET	external tank
FCS	flight control system
FPR	flight performance reserve
G&N	guidance and navigation
g	gravity acceleration
g.e.t.	ground elapsed time
h	apogee altitude
h	perigee altitude
LVLH	local vertical-local horizontal
L/D	lift-to-drag ratio
MECO	main engine cutoff
midcourse maneuver	corrective maneuver after TPI
MPAD	Mission Planning and Analysis Division
NC1	phasing maneuver

NCC	combination phase, height, and plane change maneuver
NH	height maneuver
NPL	nominal power level
NSR1	first coelliptic maneuver
NSR2	second coelliptic maneuver
OMS	orbital maneuvering system
PC	plane change maneuver
phasing	refers to central angle between vehicles, measured from center of Earth
$Q, q$	dynamic pressure
RCC	reinforced carbon-carbon
RCS	reaction control system
RSI	reusable surface insulation
RSS	root sum square
RTLS	return to launch site
SRB	solid rocket booster
SSME	space shuttle main engine
TAEM	terminal area energy management
TAI	terminal area initiation
TPF	terminal phase finalization
TPI	terminal phase initiation - first intercept maneuver
TPS	thermal protection system
TIG	time of ignition
VEI	velocity at entry interface
WTR	Western Test Range
$\alpha$	angle of attack
$\gamma$ EI	flightpath angle at entry interface
$\Delta t$	time increment
$\Delta V$	velocity increment
$\omega t$	angle of target travel from the initiation of TPI to the theoretical braking maneuver (TPF)



#### 4.0 MISSION DESCRIPTION

Mission 3B is defined as a payload retrieval and quick return mission. The total mission duration is one revolution, or approximately 2 hours. The sequence of events comprising this mission - that is, ascent, orbital operations, and entry through landing - is illustrated on figure 4-1. This sequence is time critical: Time allotted for one mission event affects the time and activities of previous and subsequent events.

The space shuttle is launched from the WTR on a launch azimuth of 198.6 degrees. Prior to lift-off, the payload (target to be retrieved) will have been maneuvered such that a position compatible with rendezvous is attained. The ascent consists of a short vertical rise for tower clearance, pitchover, SRB staging, SSME throttling for control of the downrange insertion position relative to the payload, ET jettison, and, last, orbit insertion with the OMS at 12 minutes 0.5 second g.e.t. At insertion, the orbiter is at an altitude of approximately 91 nautical miles, in an orbit of 102 by 85.5 nautical miles.

After the rendezvous operations are begun, the rendezvous is performed manually with the RCS by controlling relative range, range rate, and inertial angular rate between the payload target and the orbiter according to a prescribed schedule. The terminal phase control begins at 19 minutes zero seconds g.e.t. and continues until 33 minutes 37 seconds g.e.t., at which time the orbiter is 100 feet from the payload. After a period of stationkeeping, maneuvering to retrieval position, and passivation of the payload, the payload is retrieved and stowed; and the payload bay doors are closed at 48 minutes 40 seconds g.e.t.

The final orbital event is the orbiter deorbit maneuver scheduled for 1 hour 2 minutes g.e.t. The deorbit is performed with two OMS engines and requires a delta-V of 328.2 fps to achieve the targets for entry interface at a 400 000-foot altitude and to deplete the OMS tanks of usable propellant. Thus, an out-of-plane component is included in the deorbit maneuver, which slightly reduces the crossrange required during entry. The purpose of depleting the OMS tanks is, however, to achieve the desired c.g. location and vehicle weight at entry interface. The payload c.g. is moved aft of nominal c.g. location such that the total vehicle weight and c.g. location match that required for the vehicle TPS design reference entry trajectory.

Entry interface occurs at 1 hour 14 minutes 28 seconds g.e.t. Landing occurs at 1 hour 46 minutes 24 seconds g.e.t.

A detailed sequence of events, including g.e.t., vehicle position, vehicle weight, c.g. location, maneuver delta-V, propellant consumed, thrust direction, resultant orbits, mach numbers, equivalent airspeed, and phase elapsed time, is given in table 4-I. All input data, including the vehicle configuration, launch loading summary, and payload bay arrangement, may be found in appendix B. Appendix C contains propulsive and nonpropulsive consumables requirements. Groundtracks, attitude time lines, crew time lines, and tabular trajectory data are included in appendixes D, E, F, and G. Appendix A is a complete compilation of all guidelines/constraints and assumptions used in generating this mission.

The following sections contain detailed descriptions of each mission phase.

TABLE 4-1.- SHUTTLE BRN 3B SEQUENCE OF EVENTS

## (a) Lift-off through deorbit

Event	Start hr:min:sec, g.e.t.	Δt of event, min:sec	Geodetic position			Total vehicle weight, lb	c.g. location, %X	Propellant use <sup>1</sup> , lb	ΔV, fps
			Altitude, n. mi.	Longitude, deg	Latitude, deg				
<b>Ascent</b>									
Lift-off	00:00:00	-	-	-120.6	34.6	4 366 747	-	-	-
Pitchover	00:00:06	00:10	-	-120.6	34.6	4 211 417	-	-	-
Gravity turn	00:00:16	01:46	-	-120.6	34.6	3 943 870	-	-	-
SRB staging	00:02:02	-	4.7	-120.8	34.2	1 787 206	-	-	-
Constant thrust guidance	00:02:02	05:16	24.7	-120.8	34.2	1 436 646	-	-	-
Constant 3-g acc. guidance	00:07:18	01:11	89.9	-123.9	26.6	457 969	-	-	-
MECO	00:08:29	-	91.7	-125.4	22.6	285 177	-	-	-
ET separation	00:08:34	-	91.7	-125.5	22.2	183 445	69.4	1 151 508 (RT)	-
-2 RCS translation	00:08:34	00:08	91.7	-125.5	22.2	183 313	-	-	-
Constant attitude OMS thrust	00:09:12	-	91.5	-126.3	19.8	183 313	-	-	-
Release constant attitude thrust	00:09:34	02:27	91.3	-126.8	18.3	182 570	-	-	-
<b>ORBIT</b>									
Insertion	00:12:00	-	90.9	-130.0	8.6	176 868	67.4	6 645 (OMS)	360.0
Reconfiguration for orbital operation	00:12:00	02:00	90.9	-132.5	0.7	-	-	-	-
Initiate 180° roll, heads up	00:14:00	01:00	91.7	-132.5	0.7	-	-	-	-
Open payload bay doors	00:14:00	04:00	91.7	-132.5	0.7	-	-	-	-
Vehicle maneuvered to est. LOS	00:15:00	01:00	92.3	-133.7	-3.3	-	-	-	-
Rendezvous sensor deployed	00:16:00	01:00	92.9	-135.0	-7.3	-	-	-	-
Rendezvous sensor acq. of payload	00:17:00	01:00	93.6	-136.2	-11.3	-	-	-	-
Acq. of range-rate data from sensor	00:18:00	-	94.5	-137.5	-15.3	-	-	-	-
Maneuver to LOS attitude	00:18:30	01:00	94.9	-138.2	-17.3	-	-	-	-
Begin terminal control	00:19:00	01:00	95.3	-138.9	-19.3	176 570	67.4	-	-
Brake to 40 fps	00:26:20	-	102.8	-151.3	-47.3	-	-	-	-
" 35 fps	00:27:13	-	103.6	-153.9	-51.4	-	-	-	-
" 30 fps	00:28:07	-	104.5	-156.8	-54.6	-	-	-	-
" 25 fps	00:29:00	-	105.2	-159.7	-57.9	-	-	-	-
" 20 fps	00:29:53	-	105.8	-163.1	-61.0	-	-	3 977 (RCS)	160.0
" 15 fps	00:30:47	-	106.5	-168.0	-64.2	-	-	-	-
" 10 fps	00:31:40	-	107.1	-173.0	-67.1	-	-	-	-
" 5 fps	00:32:36	-	107.5	-179.7	-69.8	-	-	-	-
" stationkeeping	00:33:34	-	107.9	-171.1	-72.4	172 180	67.6	-	-
Stationkeeping	00:33:37	-	107.9	-169.9	-72.6	-	-	407 (RCS)	-
Maneuver to retrieval position	00:35:00	03:00	107.0	-151.3	-75.3	-	67.6	-	-
Deploy manipulators	00:38:00	01:30	106.8	-118.0	-75.7	-	-	-	-
Retract payload appendages	00:38:30	-	106.5	96.6	-73.2	-	-	-	-
Null relative velocity	00:38:30	00:06	106.5	96.6	-73.2	-	67.6	-	-
Grapple payload	00:39:30	01:00	106.1	86.0	-70.7	-	-	-	-
Passivate payload	00:39:36	01:00	106.1	85.3	-70.4	-	-	-	-
Move payload to point above bay	00:39:36	03:36	106.1	85.3	-70.4	-	-	-	-
Move payload into bay	00:43:12	03:28	104.3	64.0	-58.6	194 640	67.4	-	-
Secure payload in bay	00:46:40	01:00	101.9	53.7	-45.5	-	-	-	-
Stow manipulator	00:47:40	01:00	101.3	51.6	-41.7	-	-	-	-
Close payload bay doors	00:48:40	03:30	100.6	49.7	-37.8	-	-	-	-
Begin deorbit preparations	00:54:00	05:00	97.7	41.5	-16.8	-	-	-	-
Deorbit ignition	01:02:00	00:00	98.1	31.5	15.2	194 243	67.4	-	-
Deorbit termination	01:04:42	02:42	96.1	27.8	25.9	188 018	66.5	6 225 (OMS)	328.2

## (b) Entry through landing

Event	Start hr:min:sec, g.e.t.	Phase elapsed time, min:sec	Geodetic position			Total vehicle weight, lb	c.g. location, %X	Mach number	Maneuver parameters	
			Altitude, ft	Longitude, deg	Latitude, deg				Equivalent airspeed, knots	True, airspeed, knots
<b>Entry</b>										
Entry interface <sup>a</sup>	01:14:28	00:00	400 000	2.7	63.0	185 675	67.5	19.8	-	-
Begin S-band communications blackout	01:17:40	03:12	319 847	-22.6	72.8	"	"	27.9	-	-
0.05 g, initiate temperature control phase	01:18:50	04:22	290 192	-38.5	75.0	"	"	29.6	-	-
Exit L-band & S-band communications	01:32:06	17:38	179 012	-124.0	45.5	"	"	12.9	-	-
TACAN acquisition of signal <sup>b</sup>	01:35:51	21:23	151 187	-121.4	39.1	"	"	7.5	-	-
Initiate terminal area <sup>c</sup>	01:41:41	27:13	68 039	-120.5	35.0	184 092	"	1.5	224	880
HSBLS acquisition <sup>c</sup>	01:44:46	30:18	16 141	120.5	34.6	"	"	0.5	266	342
Final approach phase	01:45:20	30:52	10 152	120.5	34.7	"	"	0.5	303	354
Touchdown	01:46:24	31:56	-	120.6	34.7	"	"	0.3	197	197

<sup>a</sup>See section 4.3.2 for explanation of c.g. and weight discontinuity.<sup>b</sup>TACAN location: longitude = 120.5799° W.; geodetic latitude = 34 7384° W.

TACAN acquisition criteria: elevation &gt; 3°; range rate &lt; 7596 fps; slant range to TACAN station &lt; 300 n.mi.

<sup>c</sup>HSBLS located at the far end of the runway.

Acquisition criteria: elevation angle &lt; 30°; azimuth angle with reference to runway within ± 20°; slant range &lt; 10 n.mi.

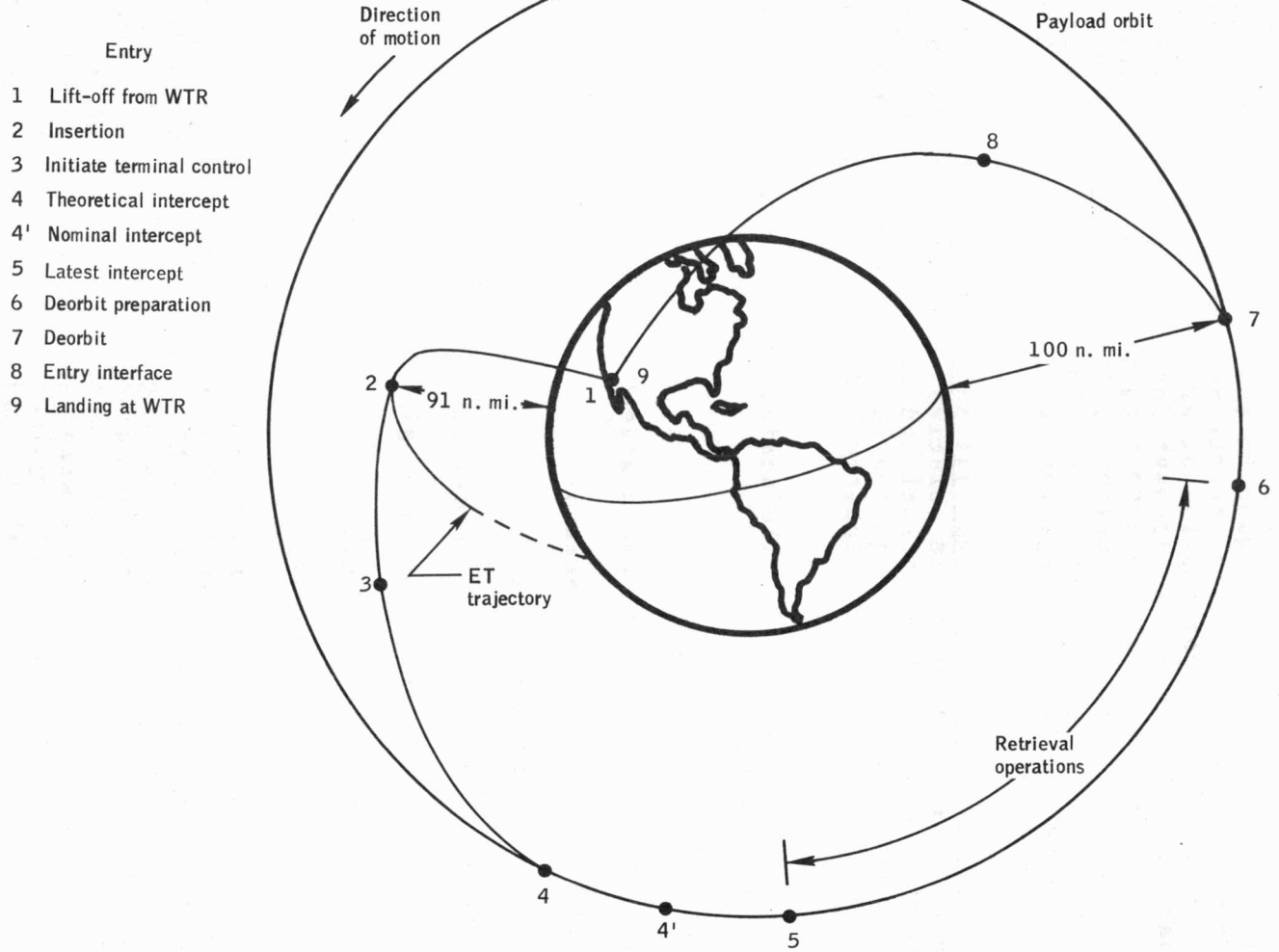

Figure 4-1.- Geometrical sketch of shuttle BRM 3B.

## 4.1 ASCENT

### 4.1.1 Lift-Off through Transfer Orbit Insertion

The nominal trajectory was designed to ensure the proper relative geometry between the orbiter and the target vehicle at orbit insertion. Within these constraints, a combination of MECO and insertion targets was chosen so that the OMS delta-V requirement for orbit insertion was minimized at the same time that the MECO targets satisfied ET impact conditions. With the use of these criteria, the weight at MECO was optimized by selecting a pitch rate of 0.39 deg/sec and a launch azimuth of 198.76 degrees from north. The trajectory conditions at key event points are presented in table 4-I.

4.1.1.1 Ascent trajectory design, guidance, and targeting. - The shuttle ascent guidance targeting is relative to a spherical Earth, and the following discussion uses both spherical and geodetic values for position. All values of vehicle position are quoted as geodetic unless otherwise specified as spherical Earth. The spherical Earth radius used in ascent targeting is 20 925 738 feet.

4.1.1.1.1 Trajectory design: The nominal ascent trajectory consists of the following phases.

- a. A 6-second vertical rise.
- b. A 10-second constant rate pitch maneuver.
- c. A gravity turn to SRB separation.
- d. Closed-loop guidance to MECO.
  - (1) Constant thrust to 3-g acceleration level.
  - (2) Constant 3-g acceleration to MECO.
- e. Orbiter/ET separation sequence.
- f. OMS burn to orbit insertion.

4.1.1.1.2 Guidance: SRB staging to MECO - The nominal 3B reference mission poses a more stringent ascent guidance problem than does a typical rendezvous mission, and all parameters that affect position and velocity must be controlled to ensure proper relative geometry at insertion. Because of the criticality of the rendezvous event time line and the relative geometry requirements for this one-revolution mission, the ascent insertion time dispersions must be minimized and the downrange distance must be controlled. To satisfy these requirements, a technique was established for the constant acceleration guidance phase. The technique involves throttling the main engines to maintain the desired relative geometry between the two vehicles. Minor adjustments in the throttle setting affect the insertion time-to-go so that the nominal rendezvous intercept time can be maintained. The desired conditions are maintained by advancing the throttle setting (decrease the time-to-go value) or by decreasing the throttle setting (increase the time-to-go value). However, since the enclosed trajectory was generated for the nominal mission, the vehicle and target dispersions were assumed to be zero; therefore, the technique of throttling the vehicle was not employed.

4.1.1.1.3 Guidance: MECO to orbit insertion - After the MECO conditions have been satisfied, the orbiter still must be guided to the proper geometry for the rendezvous. This is accomplished by using Lambert's theorem, by which the orbiter is guided to the rendezvous position at a fixed time. This time is apportioned to include both a burn arc and a coast arc; and although the total time must remain constant, the combination of burn and coast time may vary to ensure the proper position for rendezvous.

4.1.1.1.4 Targeting: The nominal mission 3B trajectory was designed to satisfy the orbit insertion conditions specified in table 4.1.1-I. The optimum MECO targets for mission 3B were determined from the acceptable range of MECO conditions shown in the sketch below. These values were obtained from reference 2 and are consistent with the ET impact constraints.

An iterative technique was used to select the best set of MECO targets to combine with the insertion targets. The best solution is shown in the sketch below.

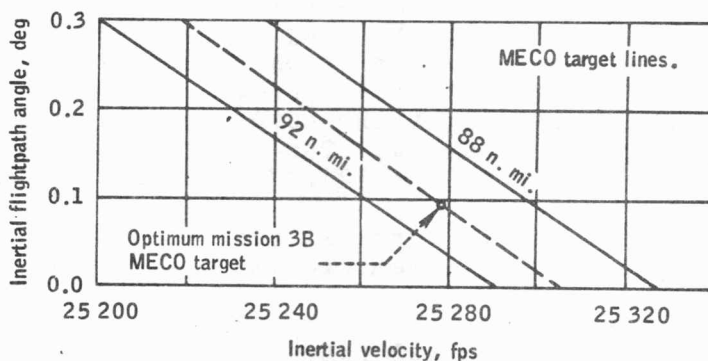

The MECO parameters within the region defined by this sketch were assumed to vary linearly. Thus, for a given radius,  $r$ , and inertial flightpath angle,  $\gamma$ , the inertial velocity,  $V$ , is uniquely determined and can be represented by

$$V = V_0 + \left(\frac{\partial V_0}{\partial r}\right)r + \left(\frac{\partial V_0}{\partial \gamma}\right)\gamma$$

where  $V$  is a constant and the partials are the slopes of the appropriate curves. Since the curves shown in the sketch are essentially parallel, the partials were assumed to be constant. The values of  $r$  and  $\gamma$  were varied iteratively, along with the OMS burn attitude, to achieve the desired insertion conditions. Among the possible solutions, the one that minimized the OMS delta-V requirement for insertion was chosen. The inertial velocity was computed from the foregoing equation during the iterative process. The converged MECO targets were as shown in table B-I, and the resulting OMS burn pitch attitude was -90.99 degrees. These values were used as input for the nominal mission 3B ascent trajectory.

4.1.1.2 Nominal ascent trajectory.- A summary of the mission 3B events and the pertinent trajectory parameters is provided in this section. The following discussion of ascent events and trajectory parameters is broken into the four major phases: booster phase, orbiter/ET guided phase, orbiter/ET separation sequence, and OMS burn to orbit insertion.

#### 4.1.1.2.1 Booster phase:

a. Launch site - Reference mission 3B is launched from the WTR at a geodetic latitude of 34.57 degrees north and a longitude of 120.62 degrees west. The geodetic altitude at the site is assumed to be 338 feet above the Fischer ellipsoid.

b. Platform alignment - At lift-off (g.e.t. = 0), the inertial platform is aligned so that the positive X-axis is parallel to the geodetic vertical at the site and is directed away from the center of the Earth; the positive Z-axis is in the geodetic horizontal plane directed downrange along the launch azimuth; and the Y-axis completes the right-handed system. The reference mission 3B launch azimuth is 198.76 degrees, measured positive clockwise from north.

c. Vehicle orientation - The vehicle is oriented on the pad with the -Z body axis (tail) pointed south. At 6 seconds, a roll maneuver is performed to orient the -Z body axis in the direction of the launch azimuth (tail down). The outer (roll), inner (pitch), and middle (yaw) gimbal angles at lift-off are -161.2 degrees, zero degrees, and zero degrees, respectively. A constant roll rate of 3.1 deg/sec is maintained until the outer gimbal angle reaches a value of 180 degrees. This maneuver requires 6 seconds.

d. Propulsion - During the boost phase, the vehicle is powered by two SRB's plus the three SSME's burning in parallel. The SRB thrust profile (fig. 4.1.1-1) is tailored to reduce heating and vehicle loads during the maximum dynamic pressure region. For mission 3B, throttle setting for the main engines is 100 percent of the normal power level (NPL) at lift-off. The NPL is then maintained throughout the atmospheric flight regime until the 3-g acceleration limit is achieved. The SRB cant angles are assumed to be zero. Staging of the SRB occurs at 121.77 seconds after lift-off.

e. Vertical rise - A 6-second vertical rise is required to achieve tower clearance. At this time, the vehicle is approximately 299.0 feet above the pad.

f. Pitchover - Following vertical rise, the vehicle is pitched about the Y-body-axis at a constant rate of 0.39 deg/sec for a period of 10 seconds. The inner (pitch) gimbal angle at the completion of the pitchover phase is -3.9 degrees; the vehicle altitude is 2373.0 feet above an oblate Earth.

g. Gravity turn - At 16.0 seconds g.e.t., a gravity turn trajectory is initiated and continued until SRB propellant depletion. During this period, the vehicle X-body-axis is maintained along the projection of the Earth relative velocity vector.

A maximum dynamic pressure of 588 lb/ft<sup>2</sup> (fig. 4.1.1-2) is encountered approximately 52 seconds after lift-off. The peak thrust acceleration during the atmospheric flight phase occurs at 106 seconds and is slightly less than the 3-g limit, as indicated in figure 4.1.1-3.

At 111.77 seconds after lift-off, SRB thrust tailoff begins. Propellant depletion occurs at 121.77 seconds, at which time the twin boosters are jettisoned. Separation of the SRB's from the orbiter is assumed to take place instantaneously. At this time, the shuttle is at an altitude of 24.7 nautical miles and at a downrange distance of 21.69 nautical miles from the launch site. The inner (pitch) gimbal angle is -57.60 degrees. The pitch, yaw, and roll gimbal angle time histories are shown in figures 4.1.1-4, 4.1.1-5, and 4.1.1-6, respectively. Time histories of pitch, yaw, and roll in an LVLH coordinate system are shown in figures 4.1.1-7, 4.1.1-8, and 4.1.1-9, respectively.

4.1.1.2.2 Orbiter/ET guided phase: The orbiter/ET guided phase, or second stage, encompasses that part of the ascent trajectory from SRB separation to main engine cutoff. During this period, the closed-loop



pitch commands are computed at 2.0-second intervals so that the specified target conditions (see table B-I) are achieved with near-optimal performance. The two guidance phases employed for the second stage are described in the following items.

a. First guidance stage - The first guidance phase of the second stage of the ascent trajectory is from SRB separation until the orbiter/ET attains the 3-g acceleration limit. During this interval, the main engines are thrusting at 100 percent. The peak acceleration is achieved at 437 seconds g.e.t. The acceleration and main engine thrust profiles are shown in figures 4.1.1-3 and 4.1.1-10, respectively.

Closed-loop steering is initiated at 121.77 seconds after lift-off. Time histories of the steering commands and the estimated time-to-go are provided in figures 4.1.1-11, 4.1.1-12, and 4.1.1-13. During the first 12 seconds of closed-loop guidance, the vehicle pitches up relative to the local horizontal. Once the desired initial attitude is attained, the pitch steering command and gimbal angle vary almost linearly with time.

b. Second guidance stage - Throughout the second closed-loop guidance phase, the SSME's are throttled to maintain an acceleration of 3 g's. The acceleration, thrust, and throttle profiles for this phase are given in figures 4.1.1-3, 4.1.1-10, and 4.1.1-14. Main engine cutoff occurs at 509.34 seconds g.e.t. At this point, the vehicle is at an altitude of 90.0 nautical miles above a spherical Earth and is 762.1 nautical miles downrange of the launch site (fig. 4.1.1-15). The instantaneous plane of the suborbital trajectory is inclined 104.0 degrees relative to the Earth's equator.

4.1.1.2.3 Orbiter/ET separation sequence: The orbiter/ET separation sequence, which lasts for 65 seconds, consists of two coast maneuvers, an RCS maneuver, and an OMS maneuver. The first coast lasts for 5 seconds and provides time to set the switches required for physical separation. While maintaining the cutoff inertial attitude, the orbiter performs an RCS translation to avoid recontact with the ET. The RCS translation lasts for 8 seconds, during which a 4-fps velocity impulse is applied in the direction of the orbiter -Z body axis. The inner (pitch) gimbal angle at this time is -104.3 degrees; so for the heads-down launch configuration, the resultant velocity is approximately in the direction of the gravity vector. The thrust acceleration during the translation interval is assumed to be 0.5 ft/sec<sup>2</sup>.

To obtain further vertical clearance, a 30-second coast is performed following the RCS maneuver. Before performing the insertion maneuver, a 22-second +X OMS maneuver is performed to obtain longitudinal clearance from the tank. The relative motion between the orbiter and the ET is shown in figure 4.1.1-16. No recontact problems exist at separation or during the OMS burn.

The OMS maneuver is performed with two 6000-pound constant thrust engines that have a specific impulse of 313.2 seconds. The engines are oriented parallel to the orbiter X-axis and pitched through the center of gravity projection in the X-Z plane. For this analysis, the effective OMS thrust and the orbiter c.g. were assumed to be in the same X-Y plane.

4.1.1.2.4 OMS burn to insertion: Following the +X OMS maneuver, the fixed inertial attitude is released and a guided OMS insertion maneuver is performed. A time-to-go profile is presented in figure 4.1.1-17. The insertion maneuver ensures that the relative geometry between the orbiter

and the target is proper to perform the rendezvous. These relative conditions are specified in section 4.2.

The OMS burn direction and duration are targeted simultaneously with the MECO conditions to achieve a specified position and time at orbit insertion. The maneuver is performed at near-constant body attitude and requires an ideal velocity increment ( $\Delta V$ ) of 360.0 fps. Orbit insertion occurs at 720.55 seconds g.e.t. The orbiter at this point is at an altitude of 90.64 nautical miles above a spherical Earth and is downrange 1640 nautical miles from the launch site.

Figures 4.1.1-18 through 4.1.1-23 are included to provide additional ascent data.



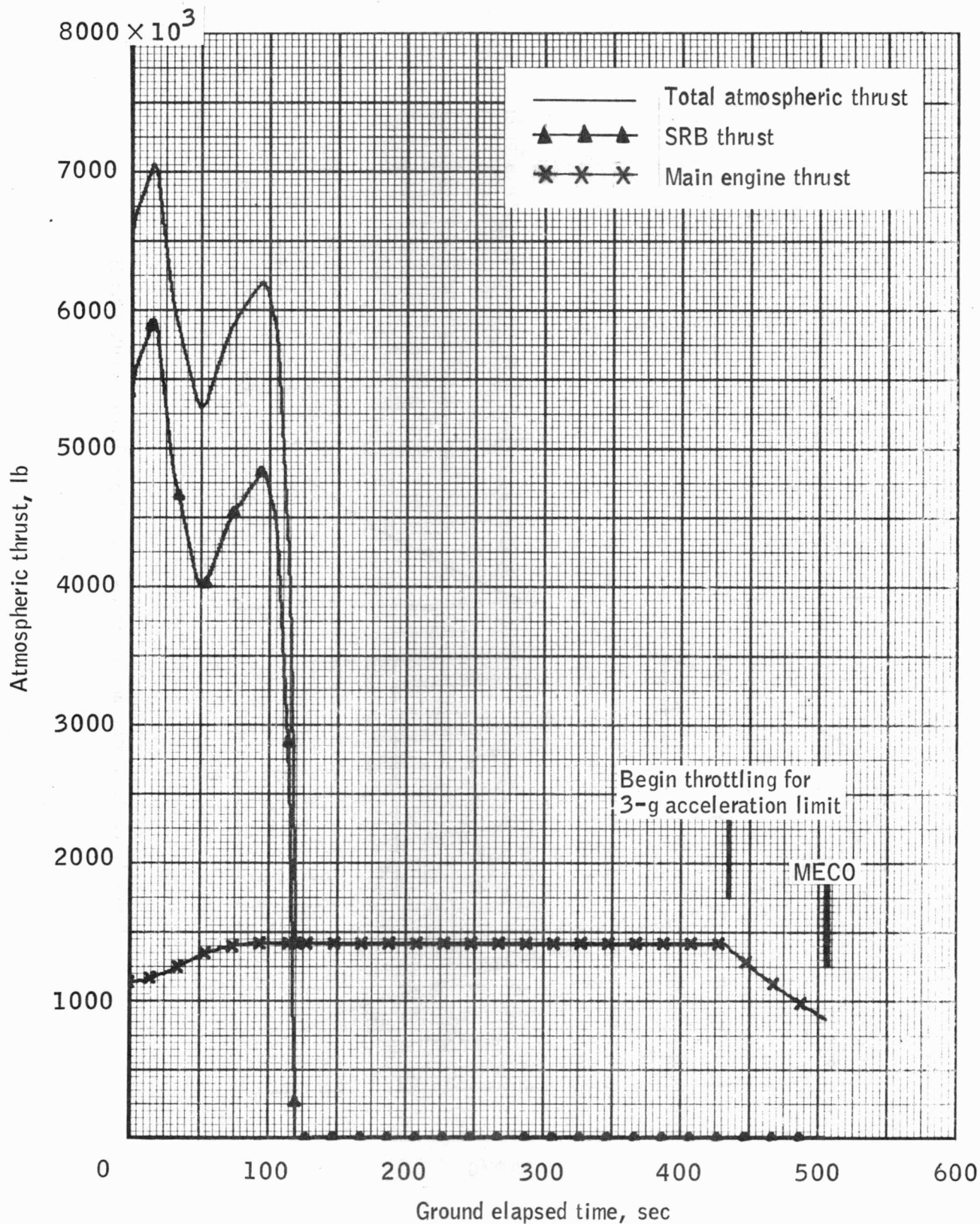

Figure 4.1.1-1.- Atmospheric thrust versus ground elapsed time for shuttle BRM 3B.

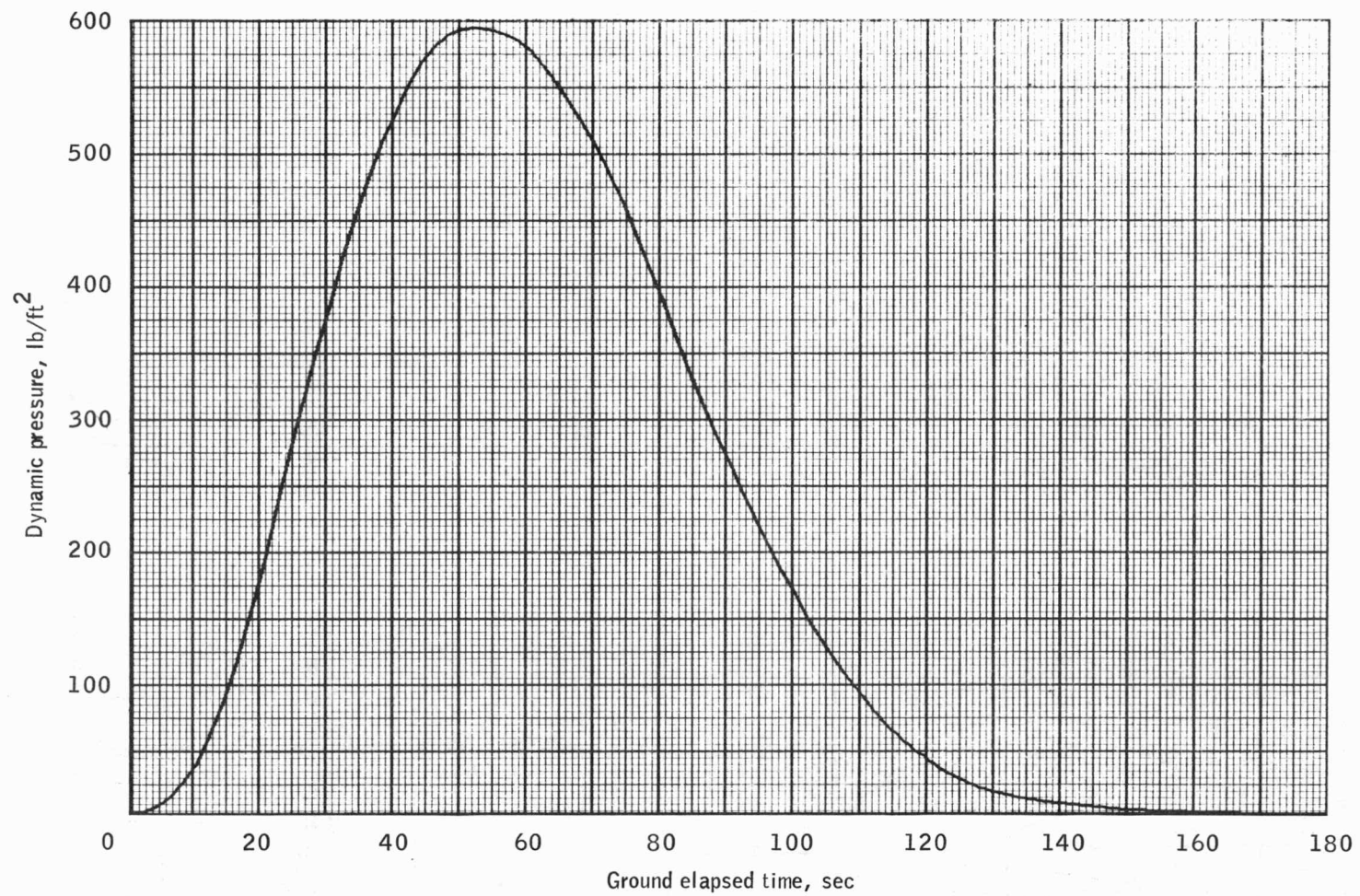

Figure 4.1.1-2.- Dynamic pressure versus ground elapsed time for shuttle BRM 3B.

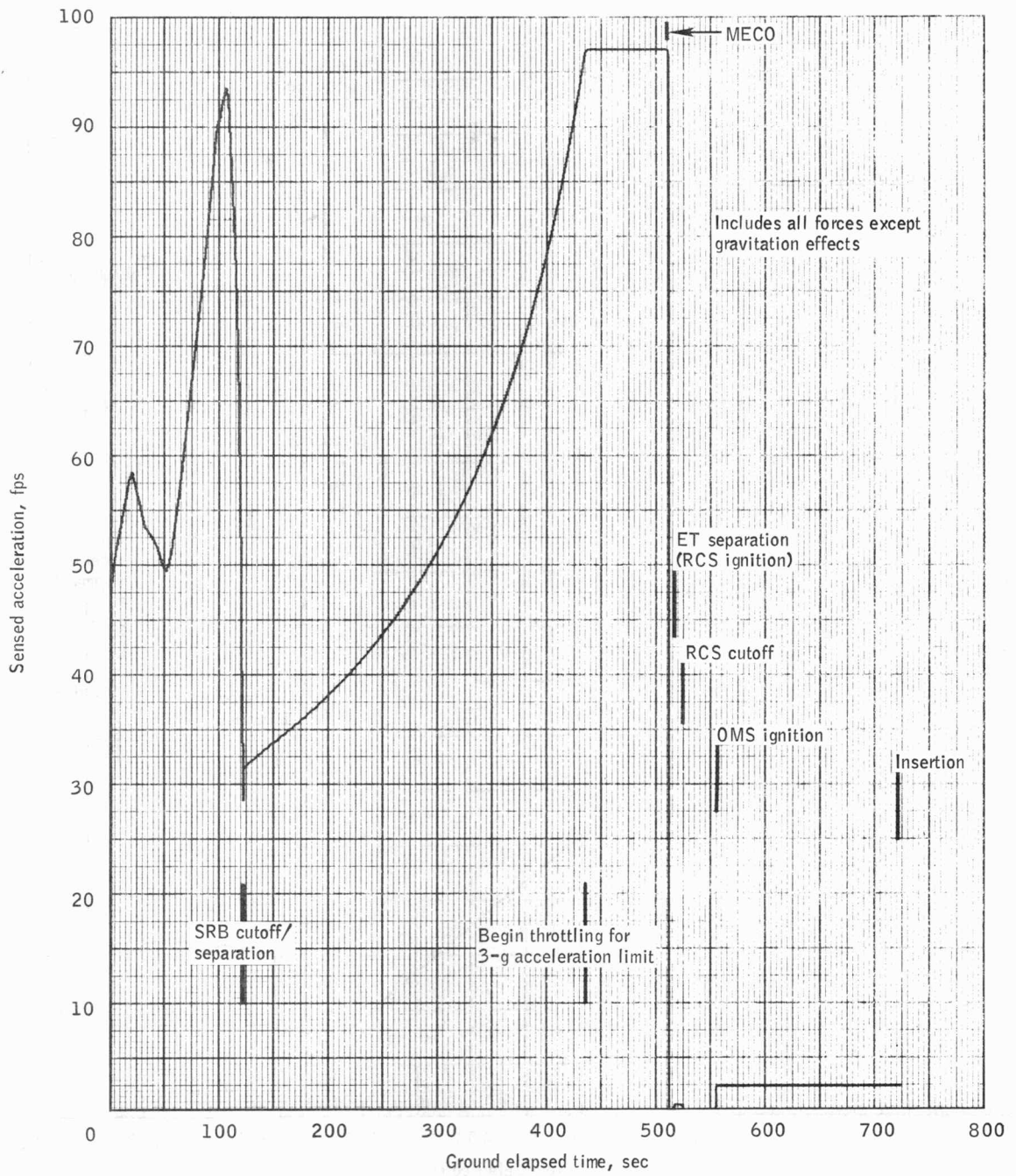

Figure 4.1.1-3.- Sensed acceleration versus ground elapsed time for shuttle BRM 3B.

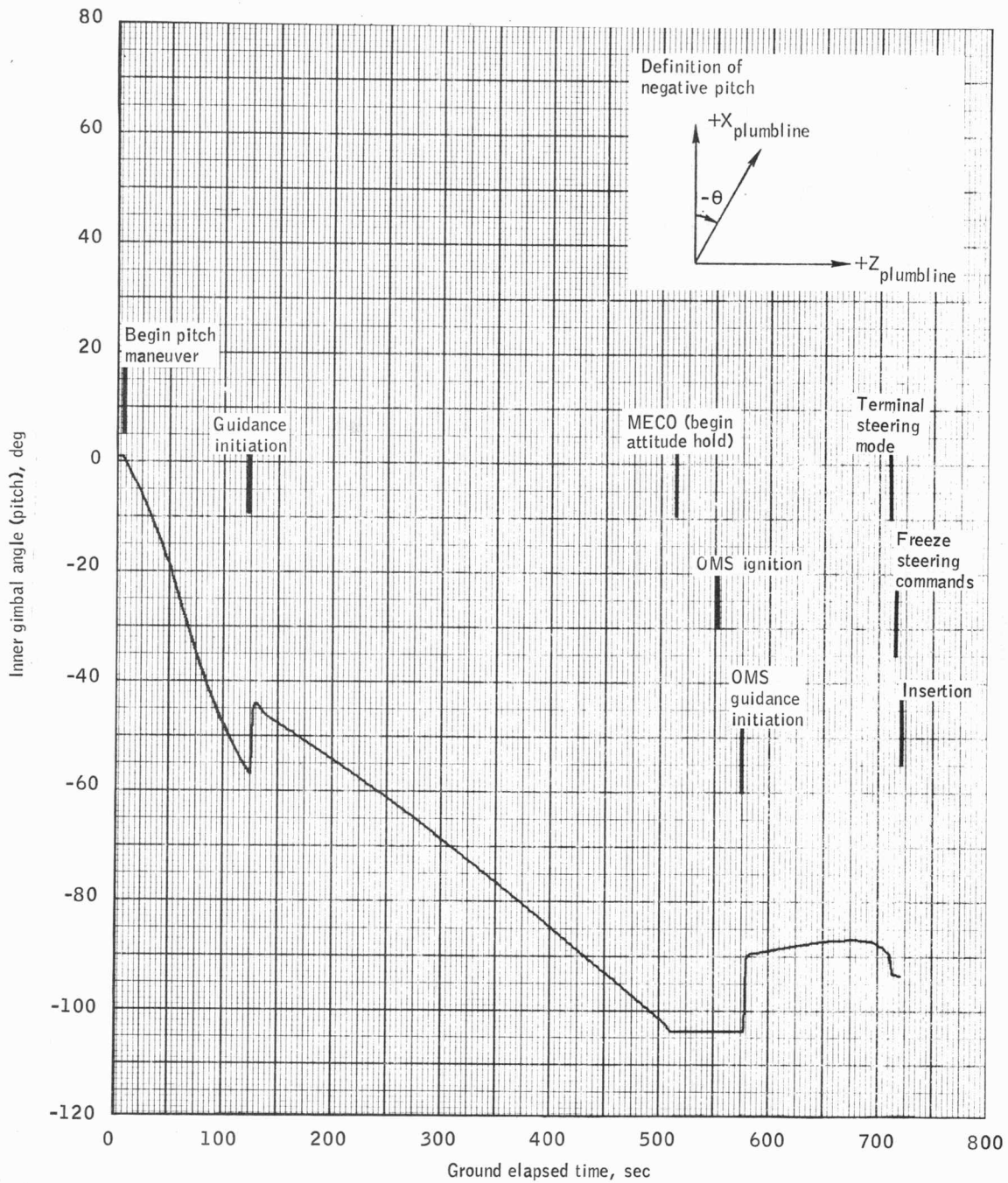

Figure 4.1.1-4.- Inner gimbal angle versus ground elapsed time for shuttle BRM 3B.



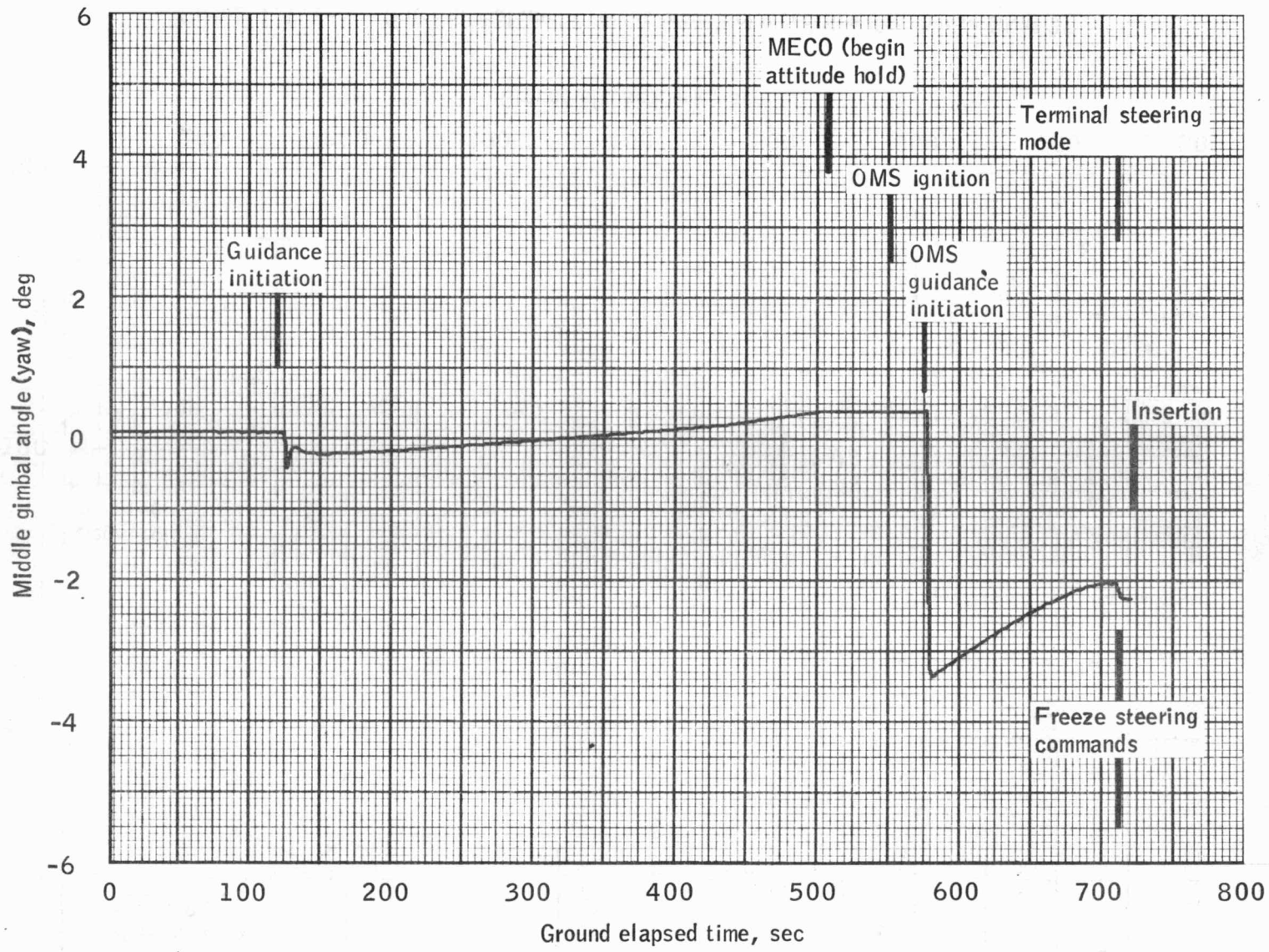

Figure 4.1.1-5.- Middle gimbal angle versus ground elapsed time for shuttle BRM 3B.

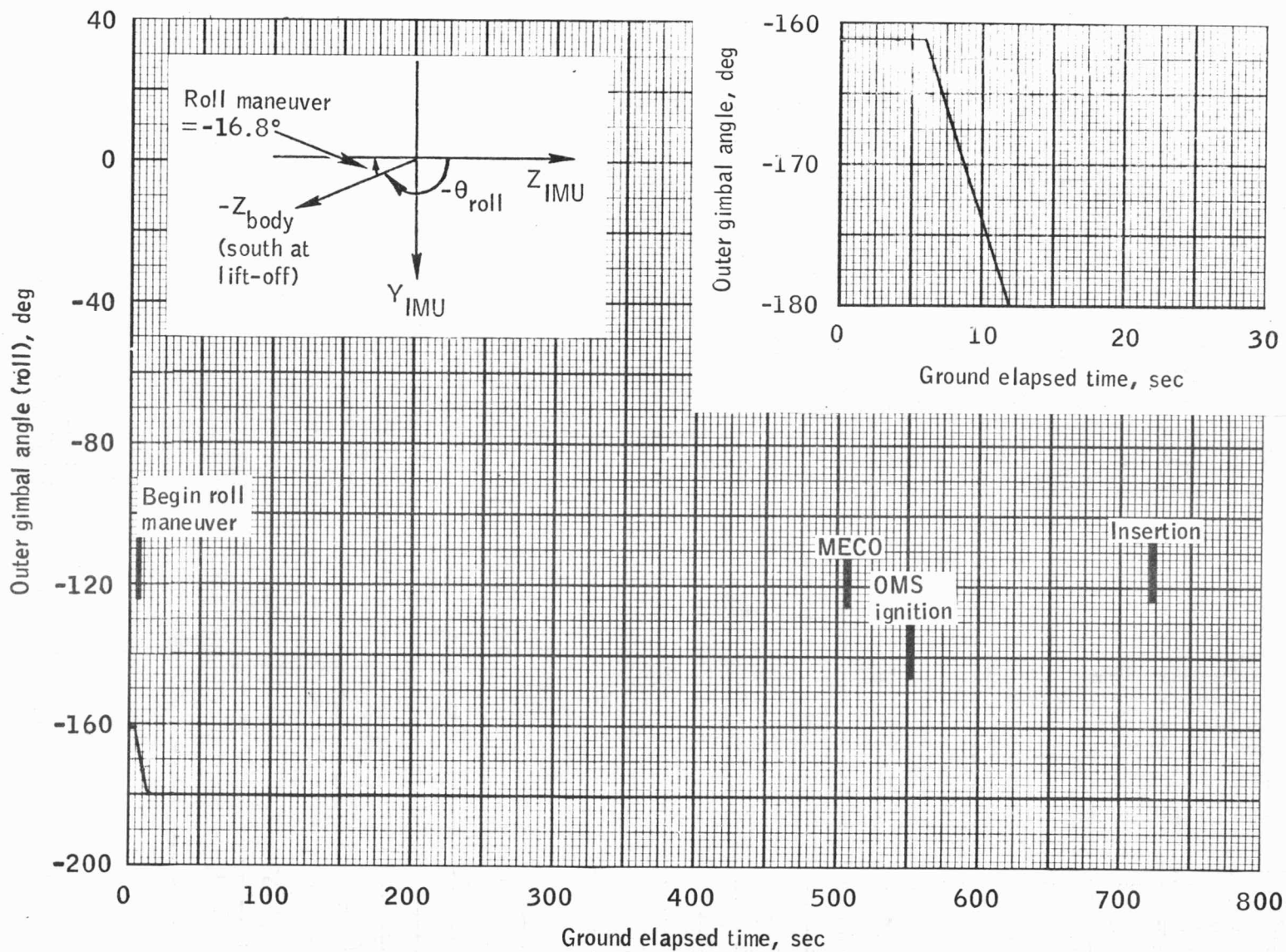

Figure 4.1.1-6.- Outer gimbal angle versus ground elapsed time for shuttle BRM 3B.

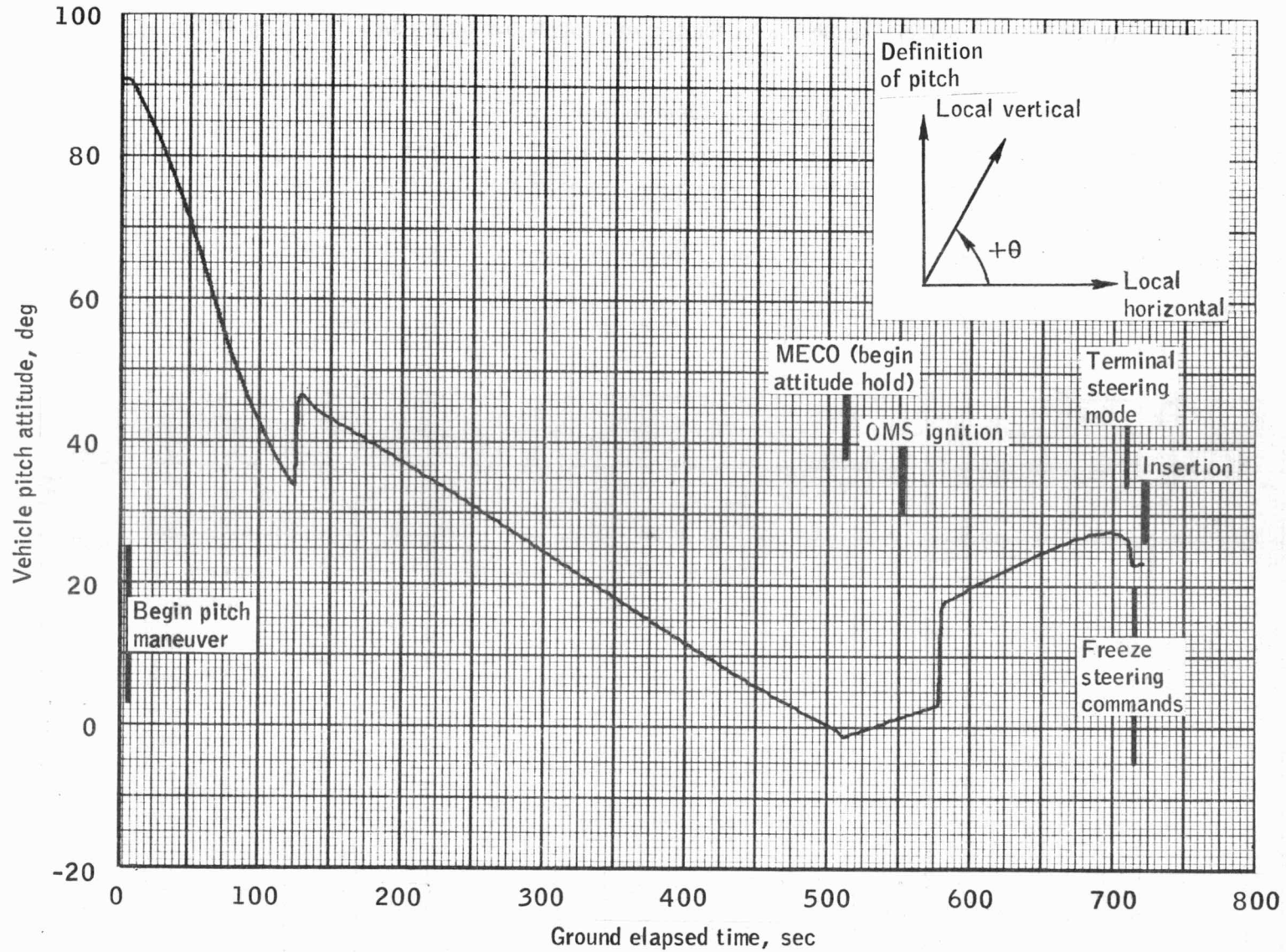

Figure 4.1.1-7.- Vehicle local-horizontal pitch attitude versus ground elapsed time for shuttle BRM 3B.

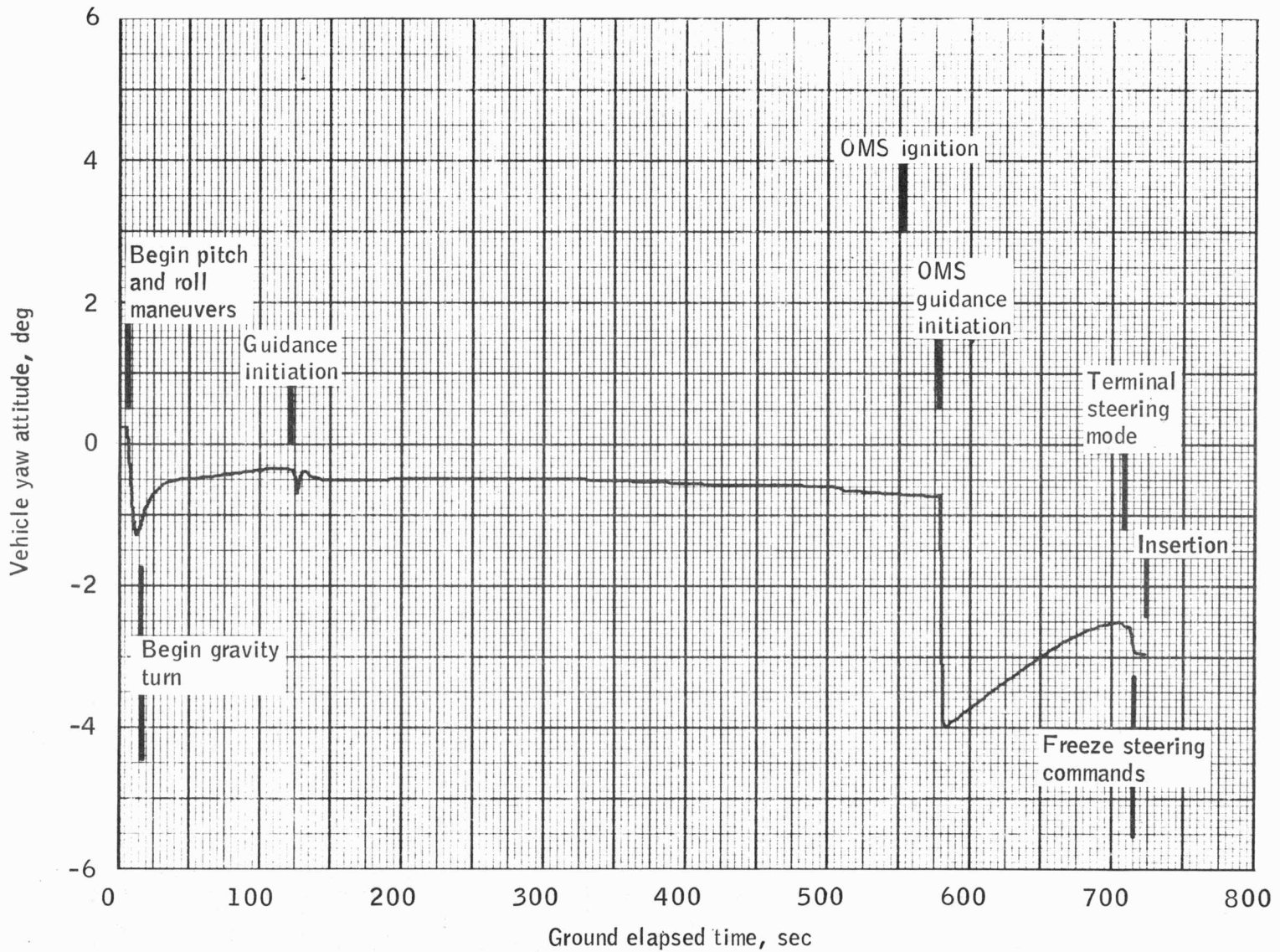

Figure 4.1.1-8.- Vehicle out-of-plane yaw attitude versus ground elapsed time for shuttle BRM 3B.



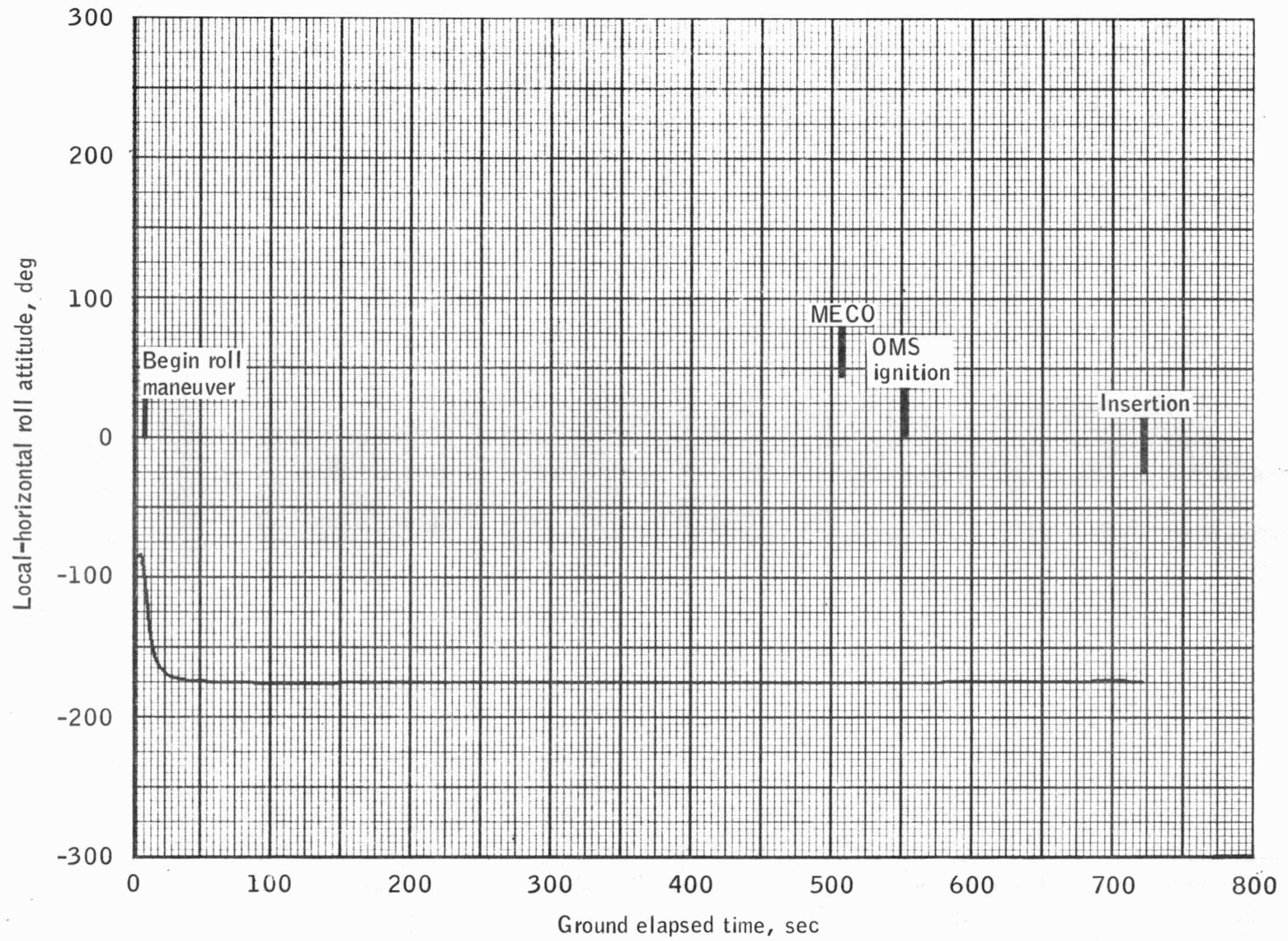

Figure 4.1.1-9.- Local-horizontal roll attitude versus ground elapsed time for shuttle BRM 3B.

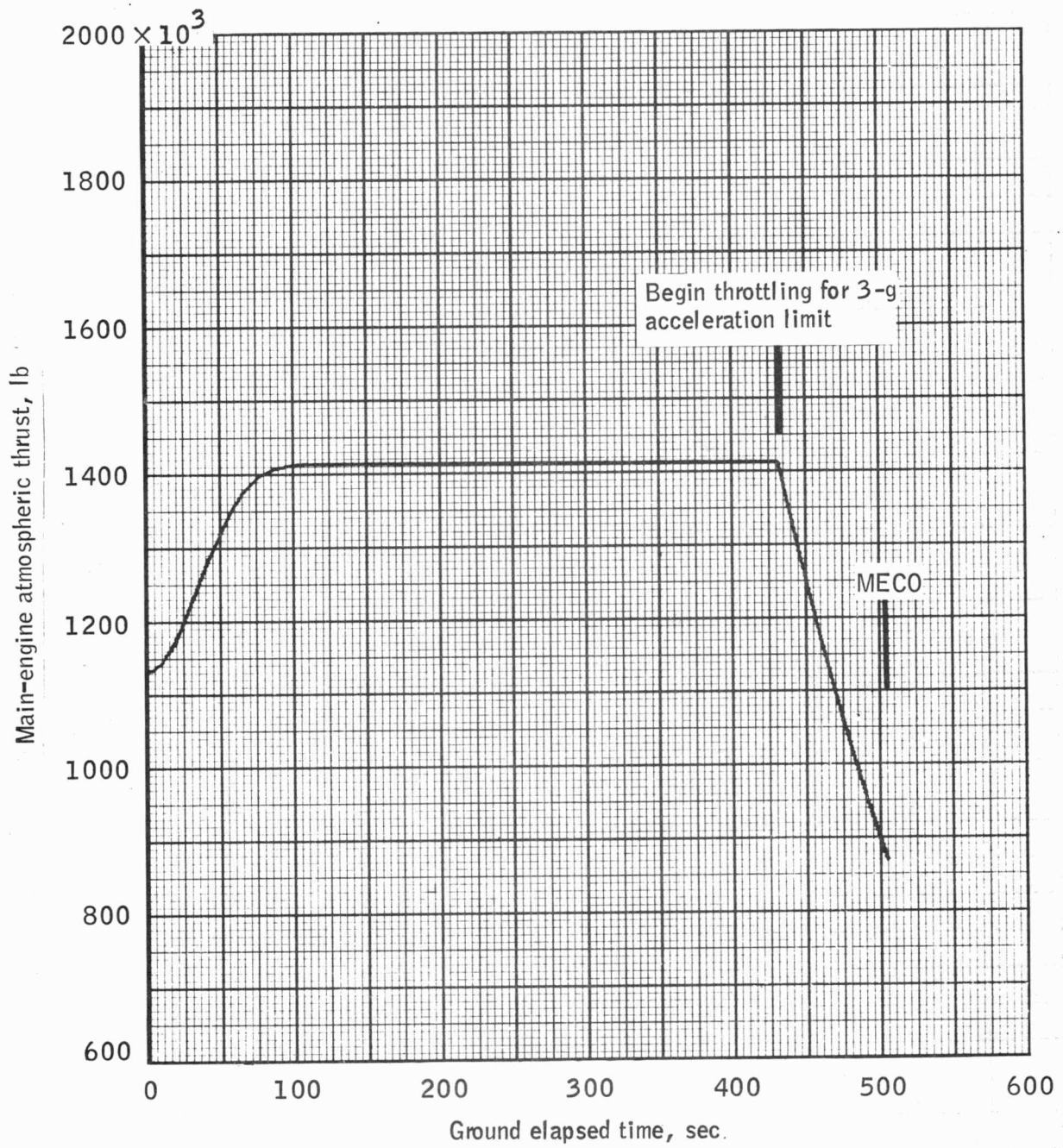

Figure 4.1.1-10.- Main-engine atmospheric thrust versus ground elapsed time for shuttle BRM 3B.

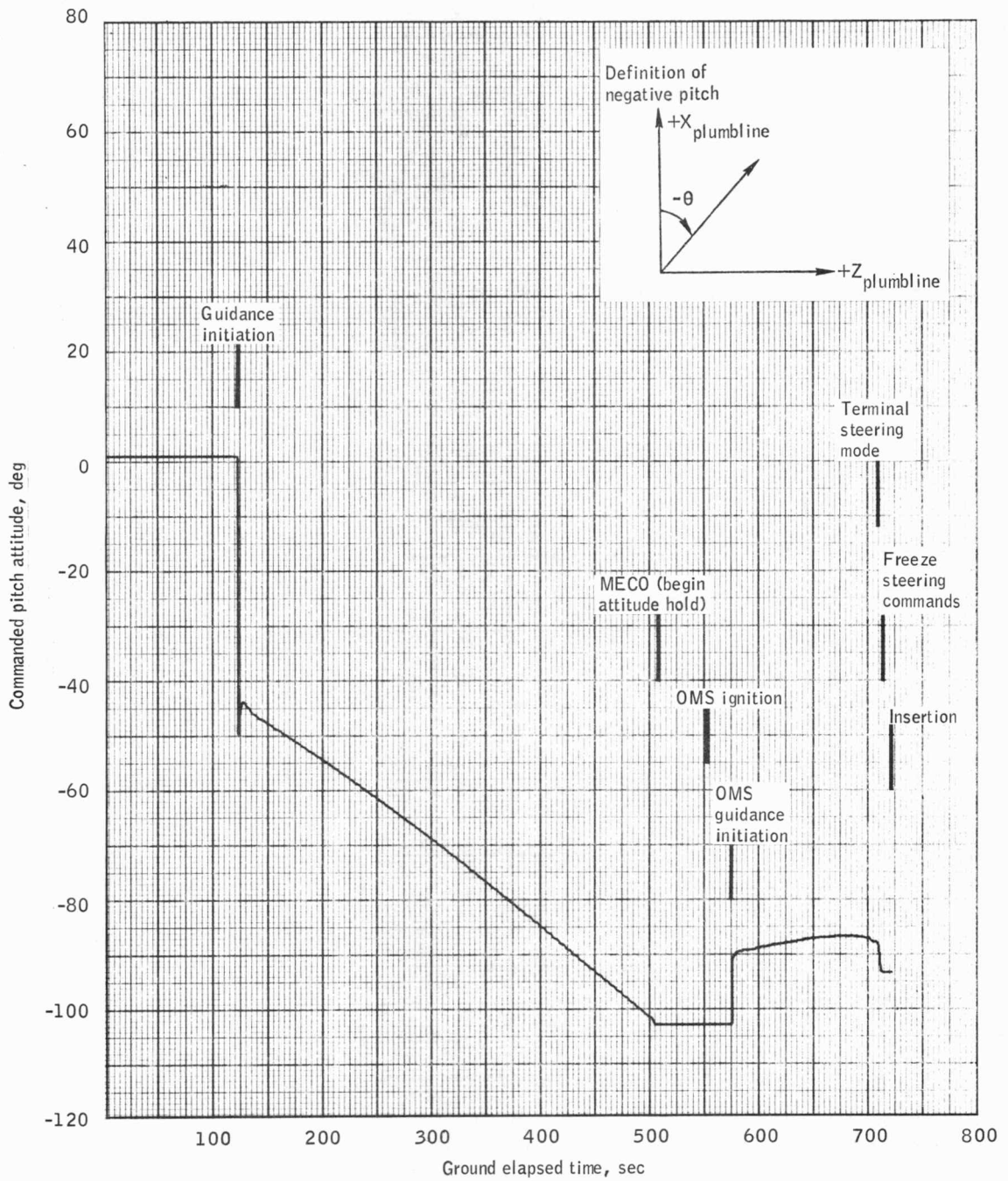

Figure 4.1.1-11.- Commanded pitch attitude versus ground elapsed time for shuttle BRM 3B.

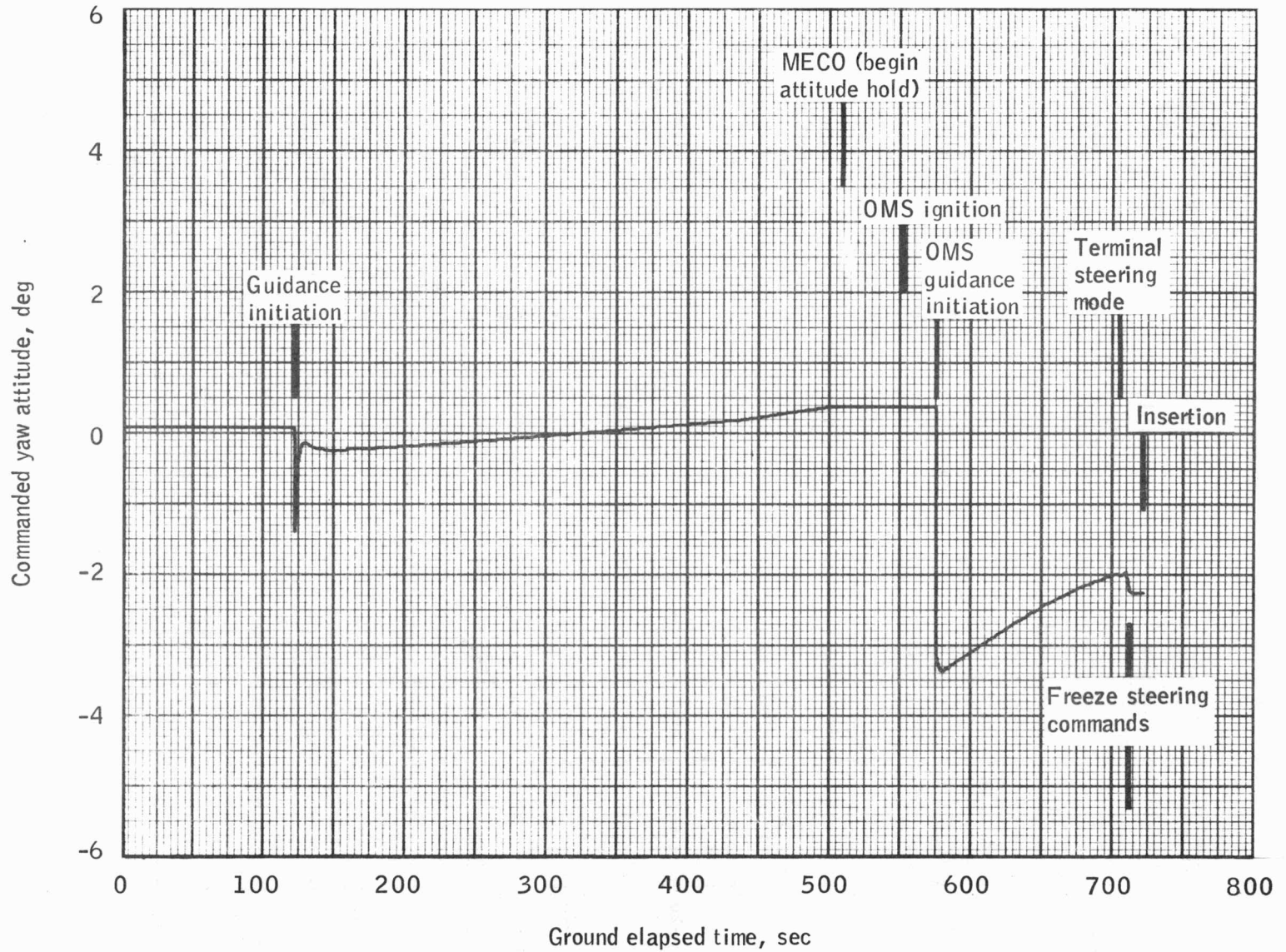

Figure 4.1.1-12.- Commanded yaw attitude versus ground elapsed time for shuttle BRM 3B.



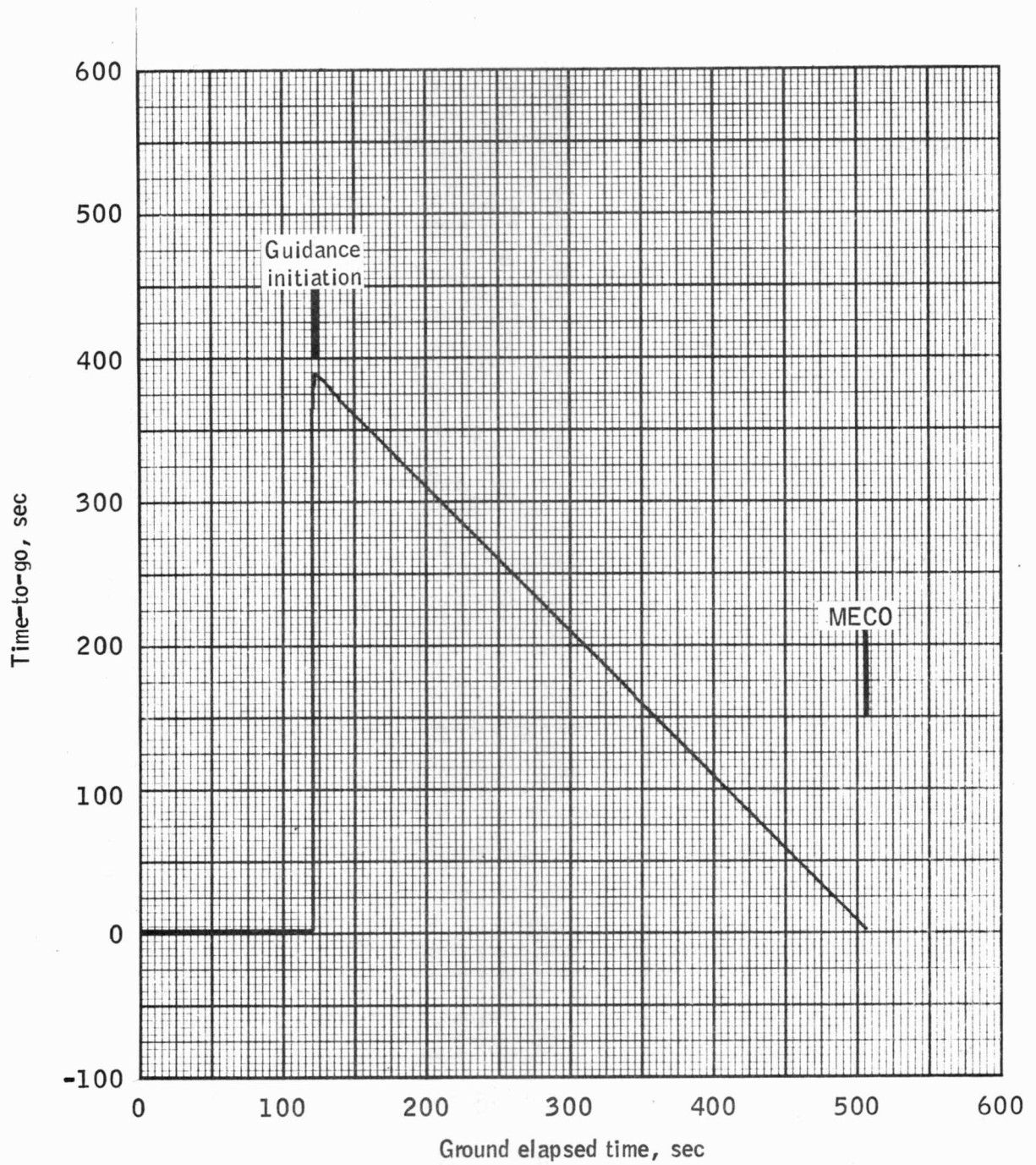

Figure 4.1.1-13.- Time-to-go versus ground elapsed time for first guidance maneuver for shuttle BRM 3B.

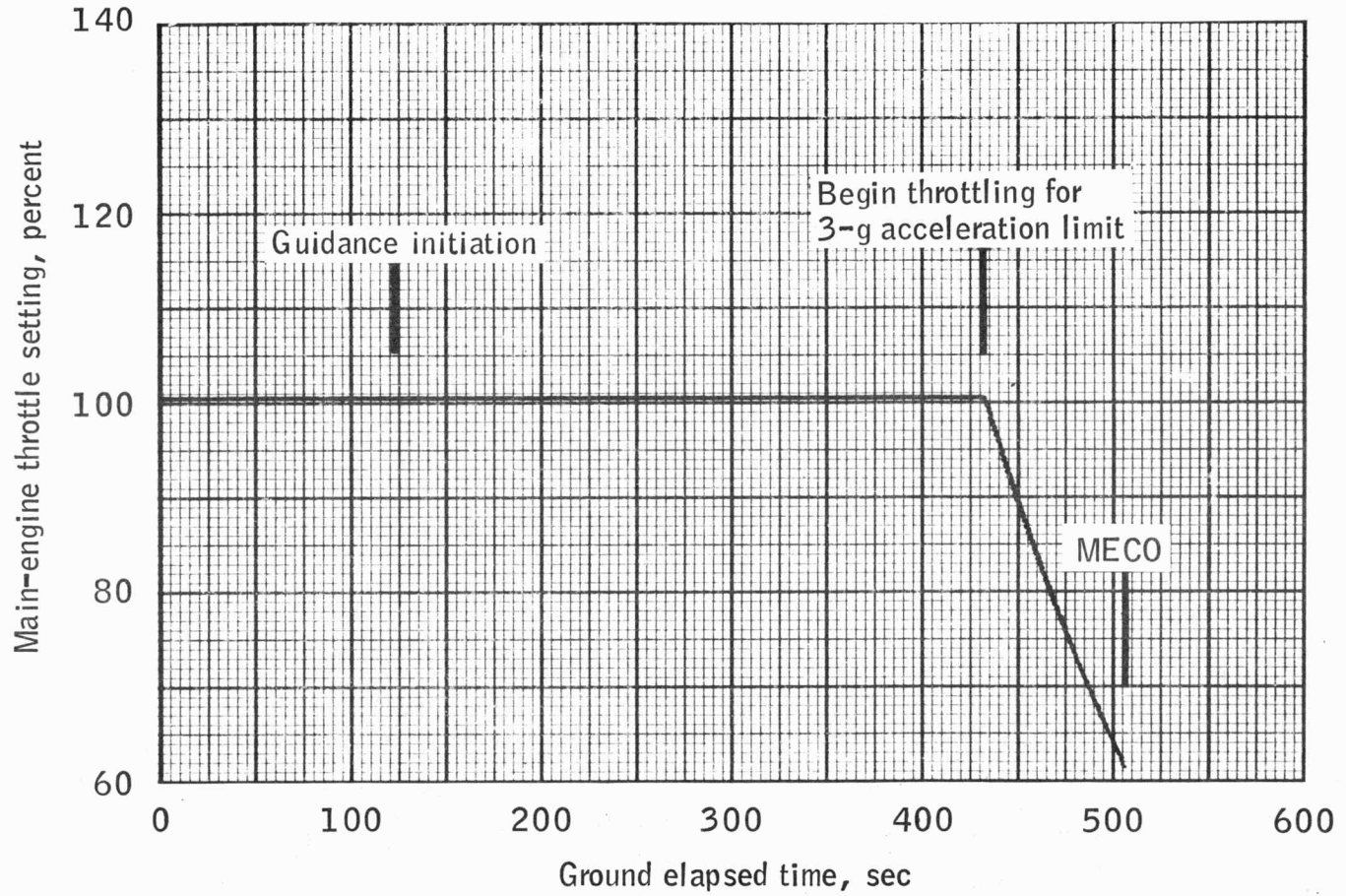

Figure 4.1.1-14.- Main-engine throttle setting versus ground elapsed time for shuttle BRM 3B.

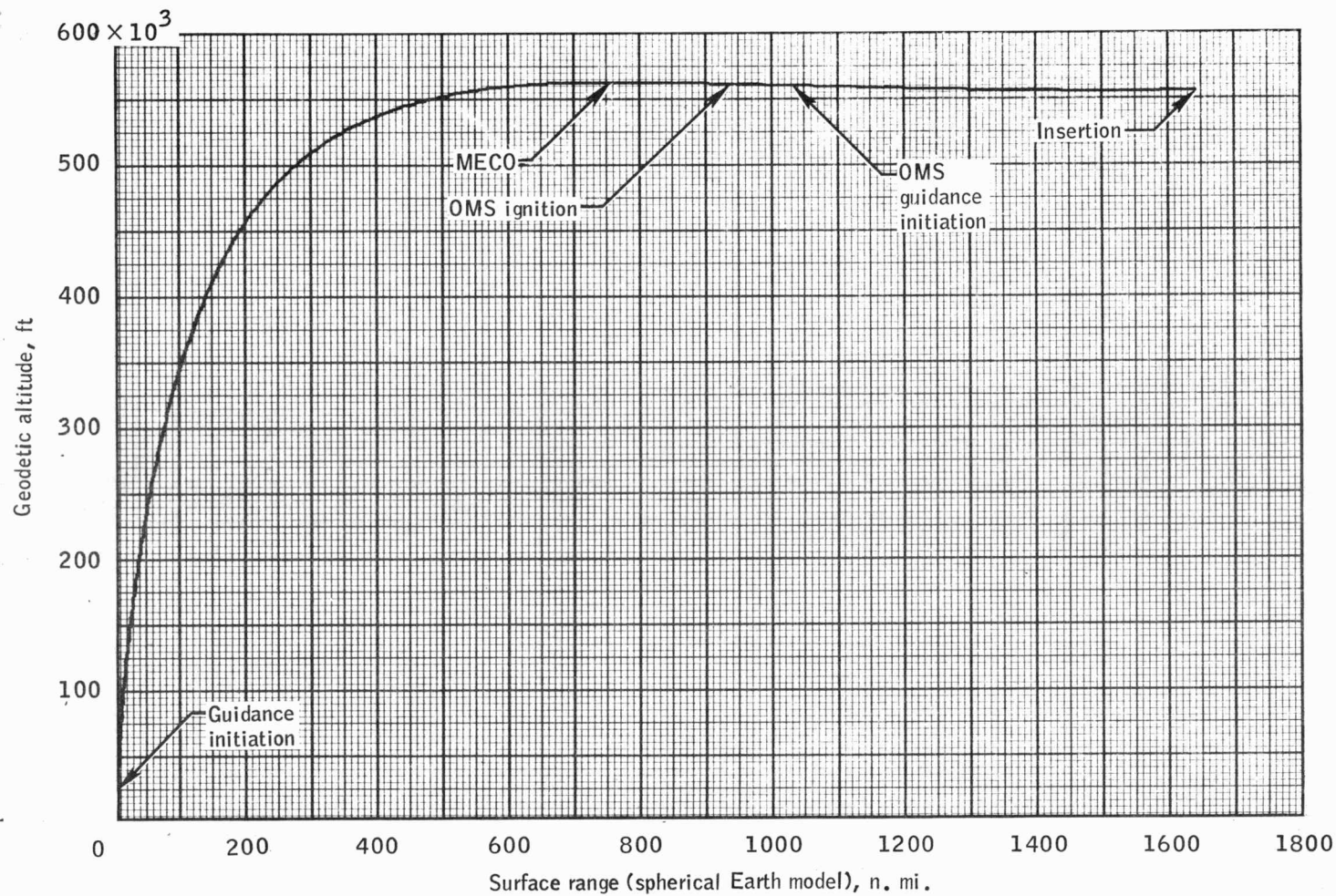

Figure 4.1.1-15.- Altitude versus surface range for shuttle BRM 3B.

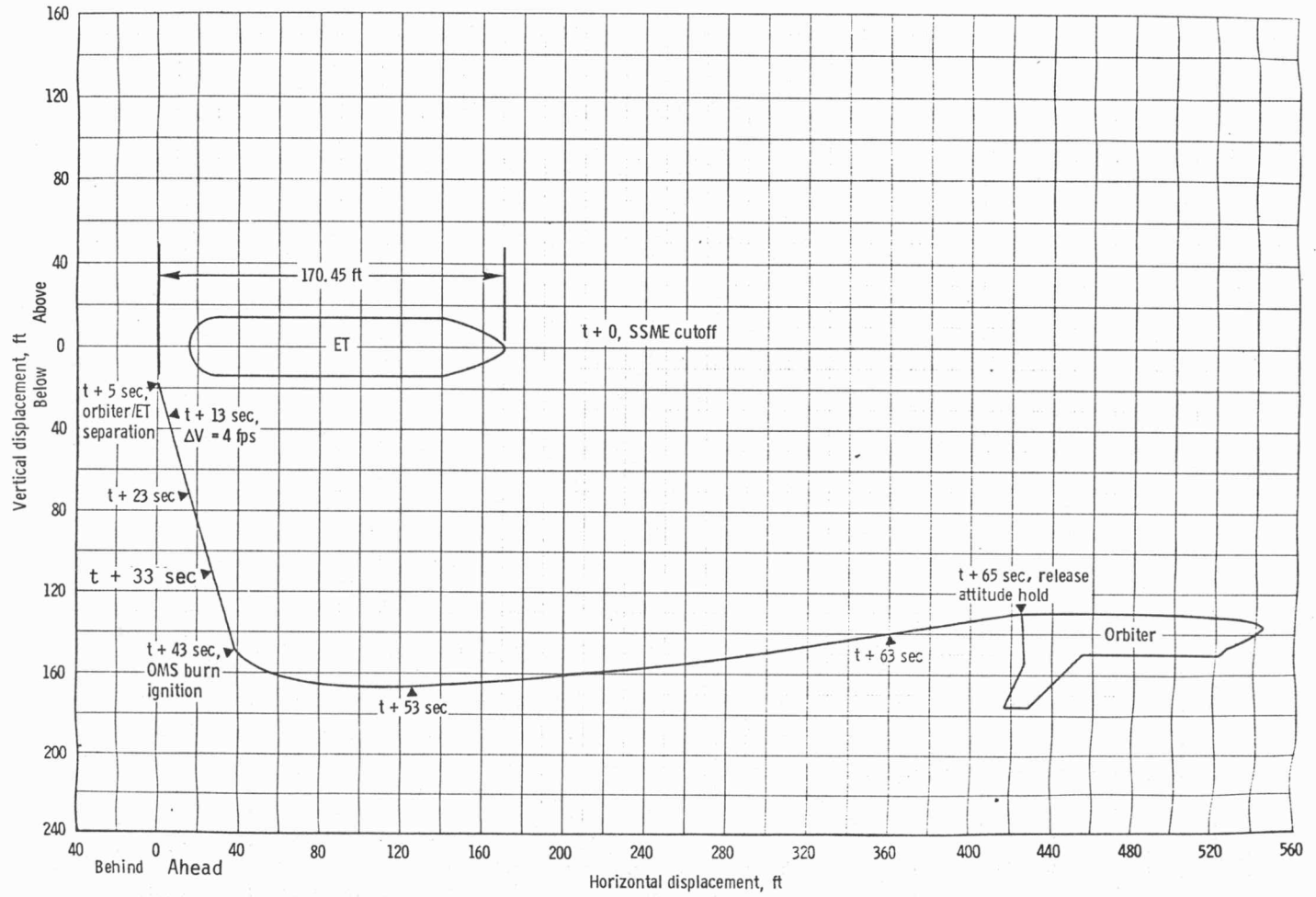

Figure 4.1.1-16.- Relative motion for orbiter/ET nominal and AOA separation maneuver.



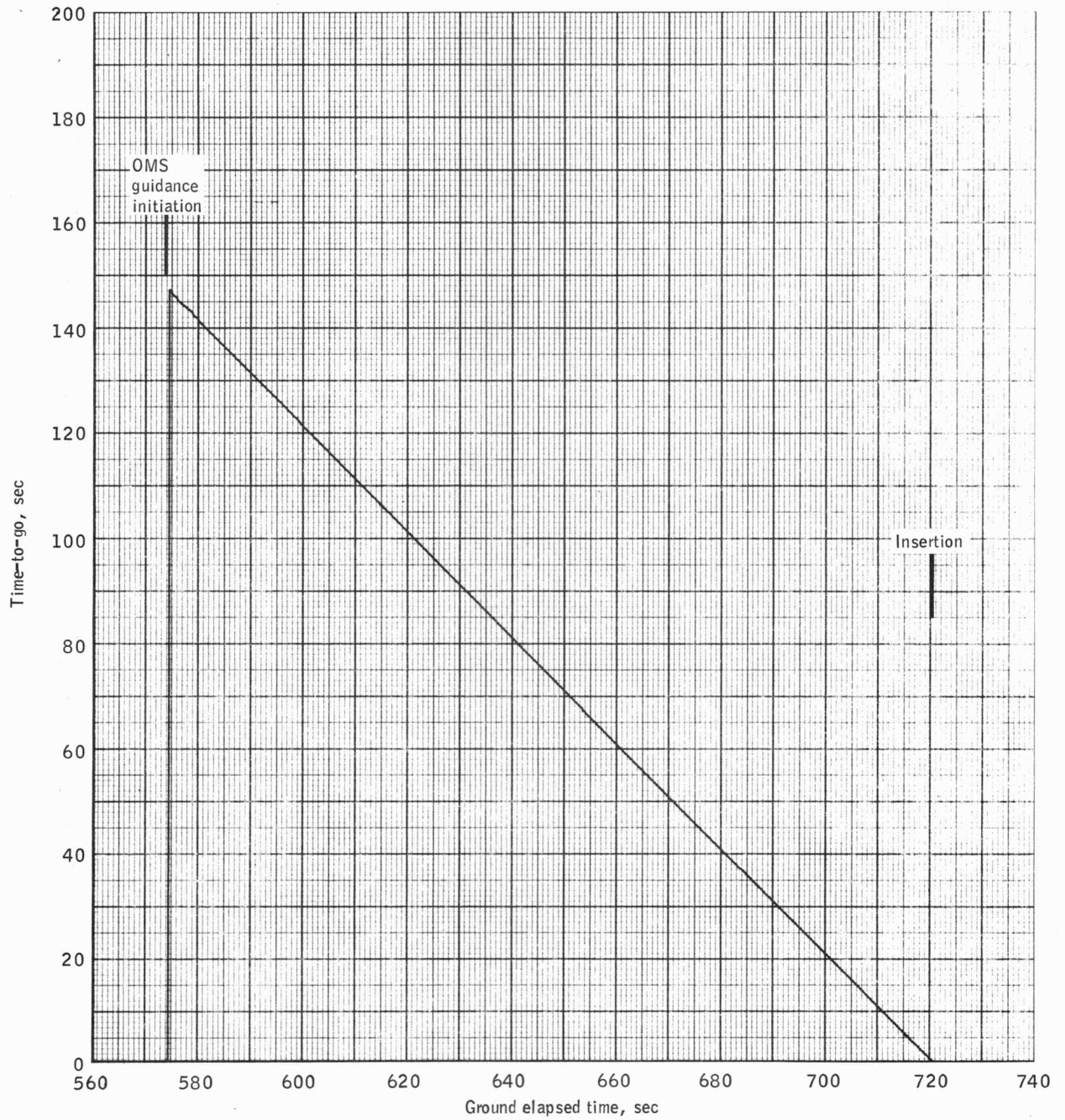

Figure 4.1.1-17.- Time-to-go versus ground elapsed time for second guidance maneuver for shuttle BRM 3B.

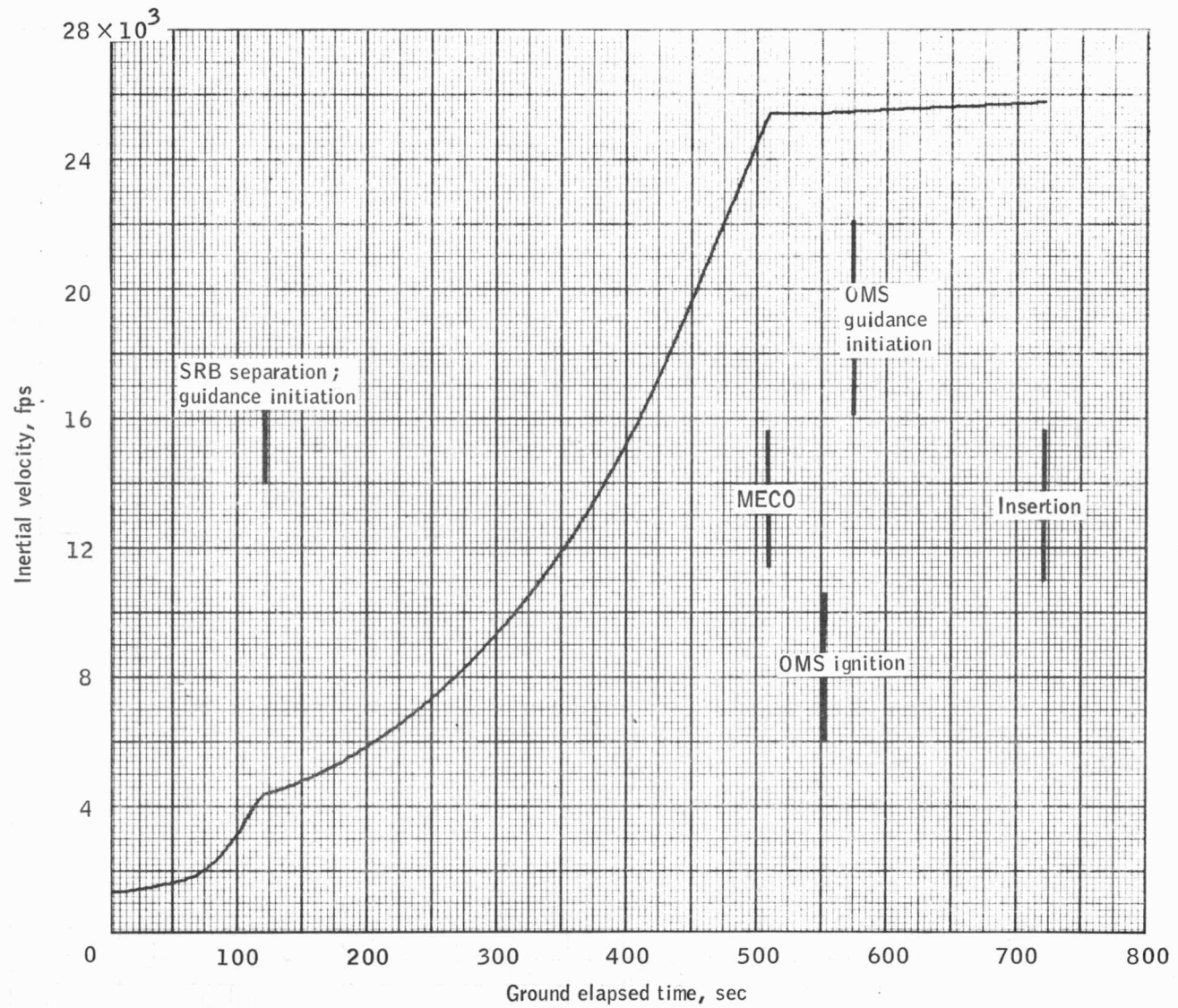

Figure 4.1.1-18.- Inertial velocity versus ground elapsed time for shuttle BRM 3B.

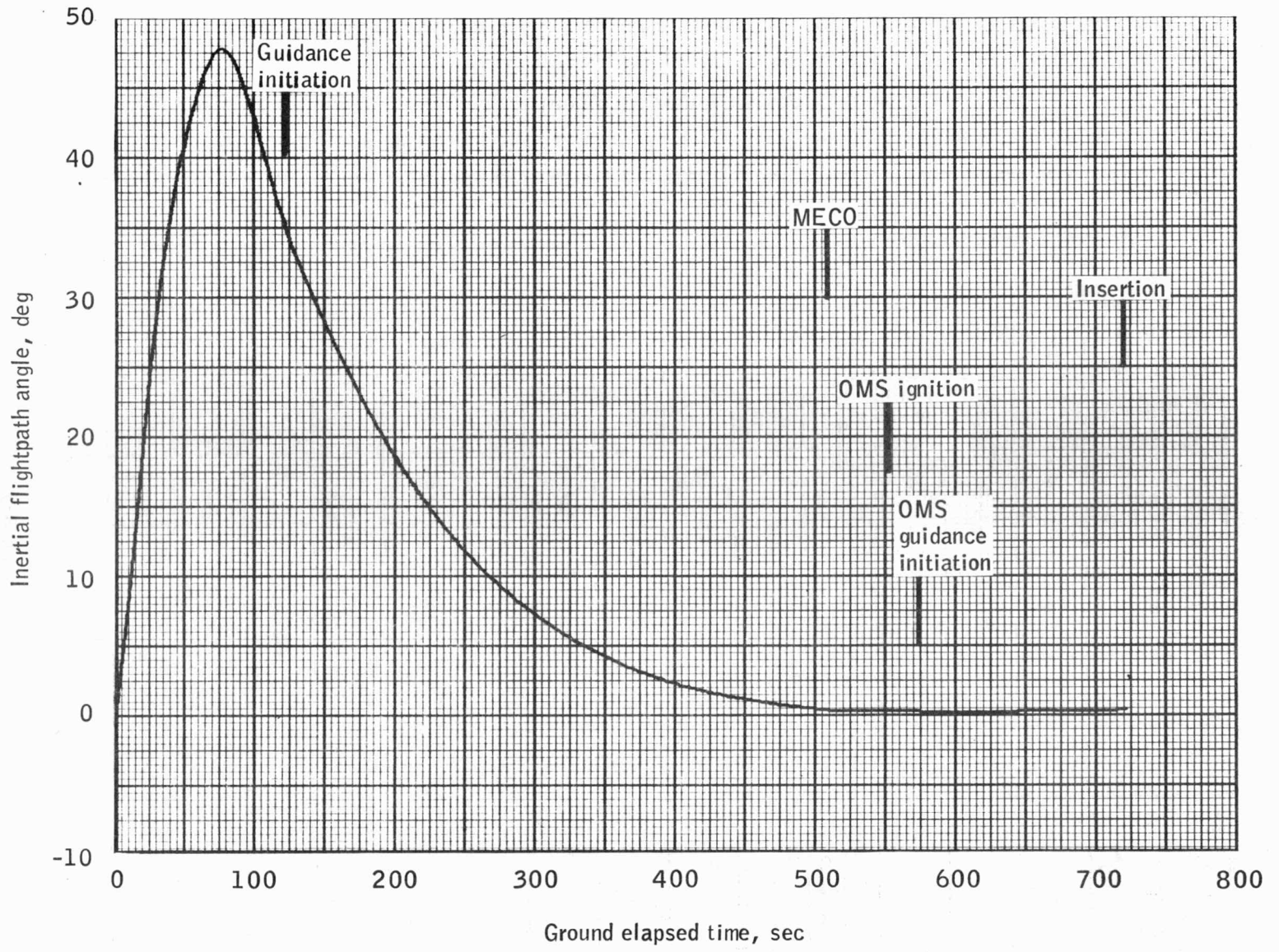

Figure 4.1.1-19.- Inertial flightpath angle versus ground elapsed time for shuttle BRM 3B.

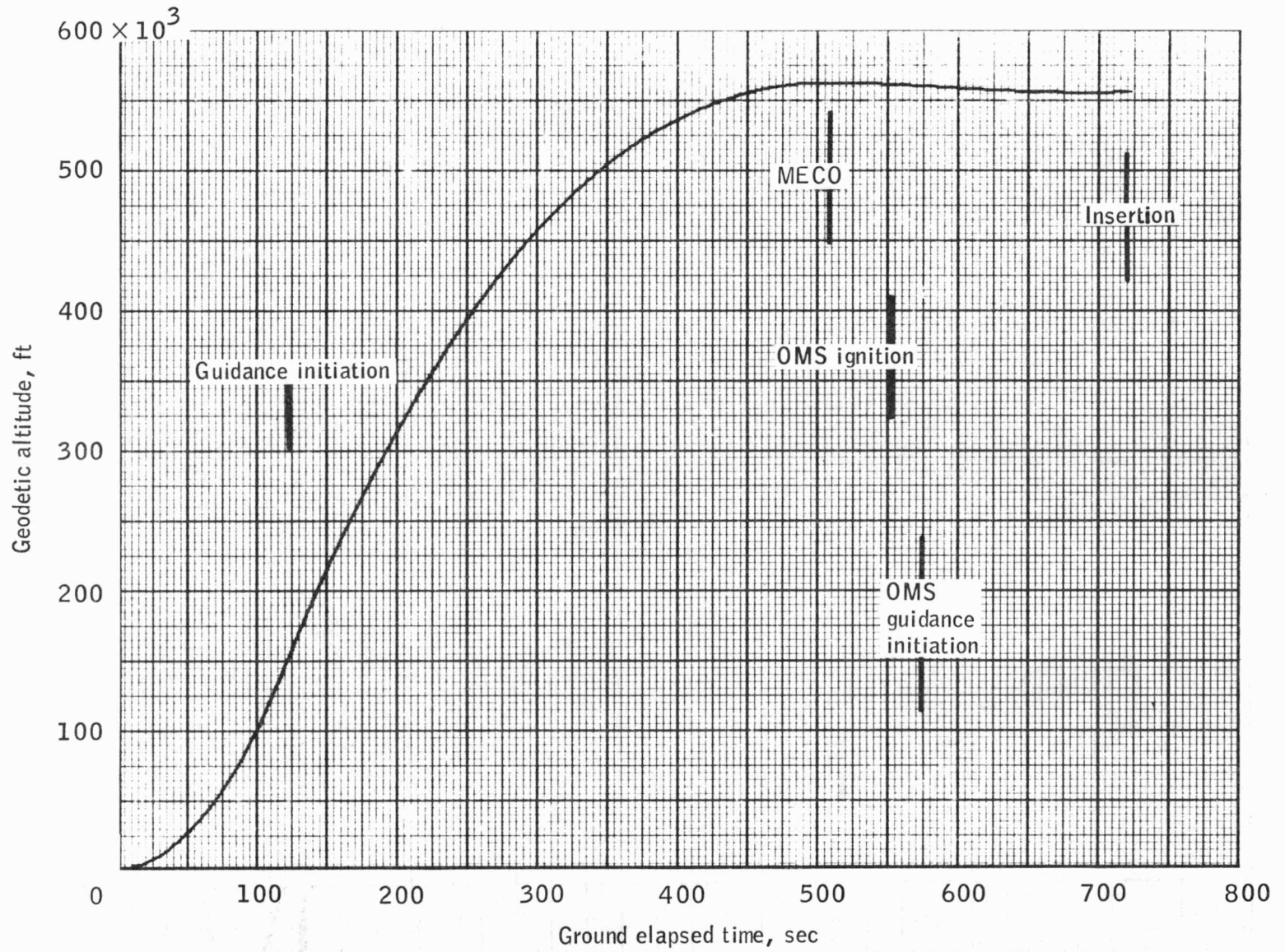

Figure 4.1.1-20.- Geodetic altitude versus ground elapsed time for shuttle BRM 3B.



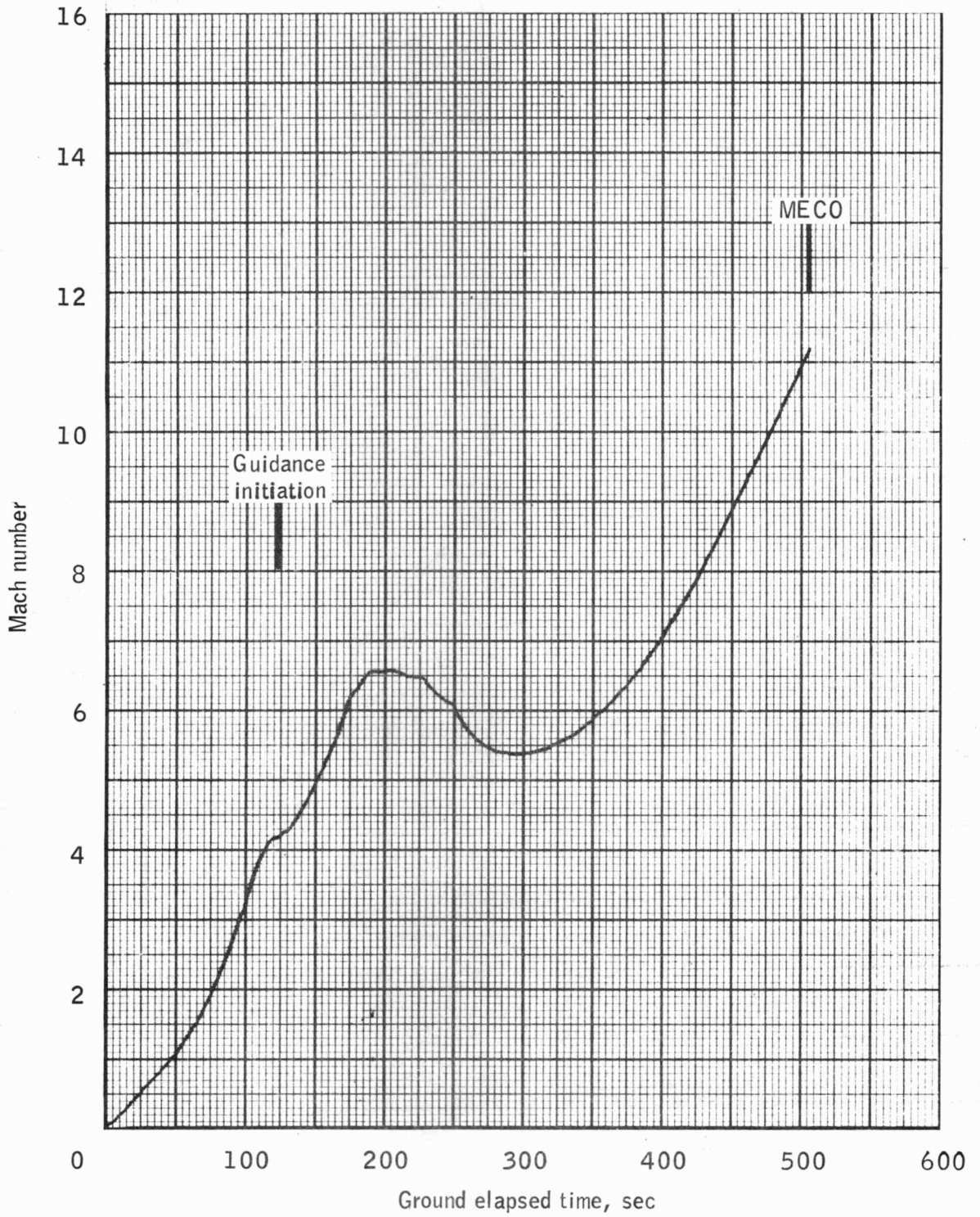

Figure 4.1.1-21.- Mach number versus ground elapsed time for shuttle BRM 3B.

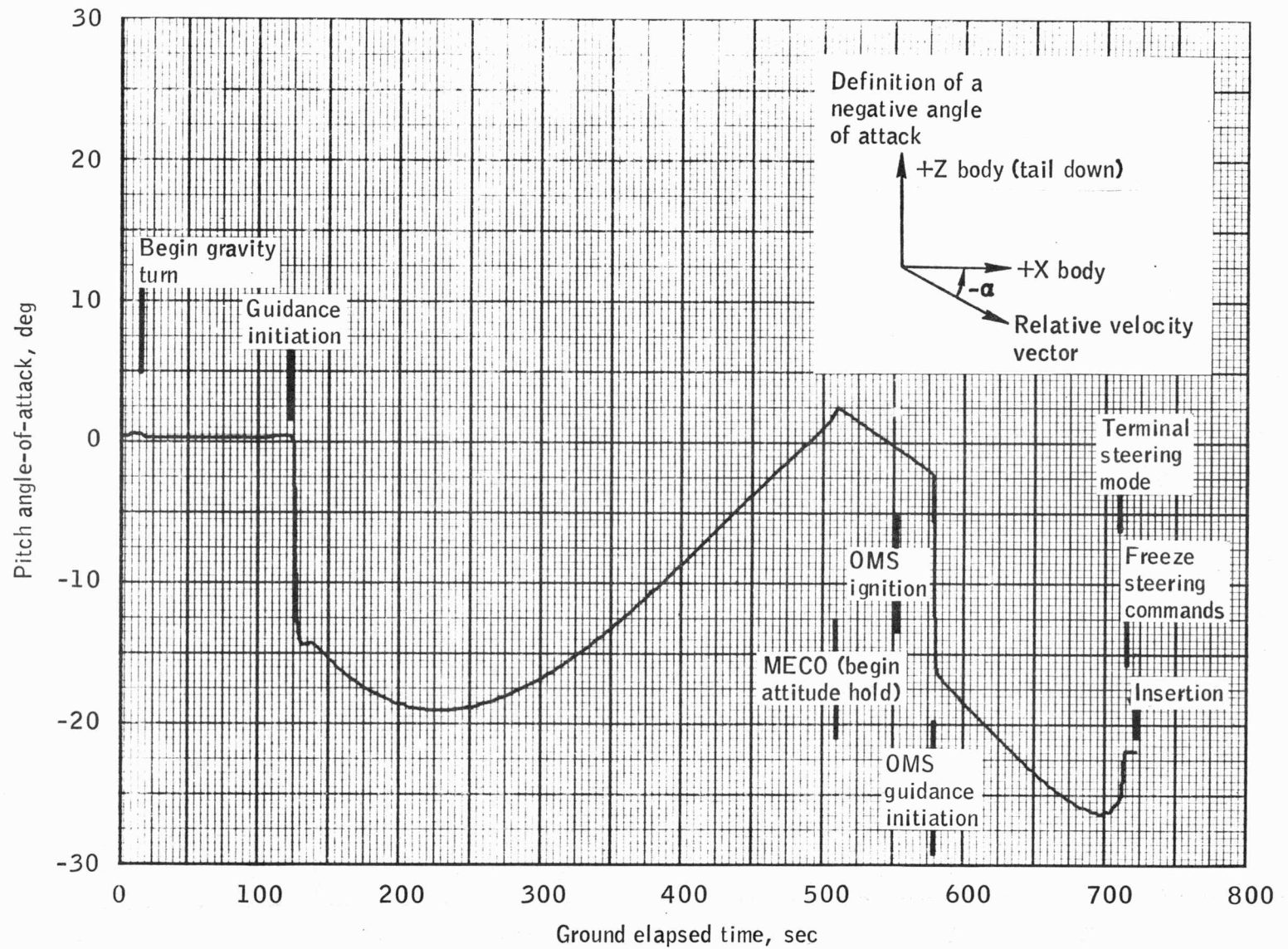

Figure 4.1.1-22.- Pitch angle-of-attack versus ground elapsed time for shuttle BRM 3B.

39

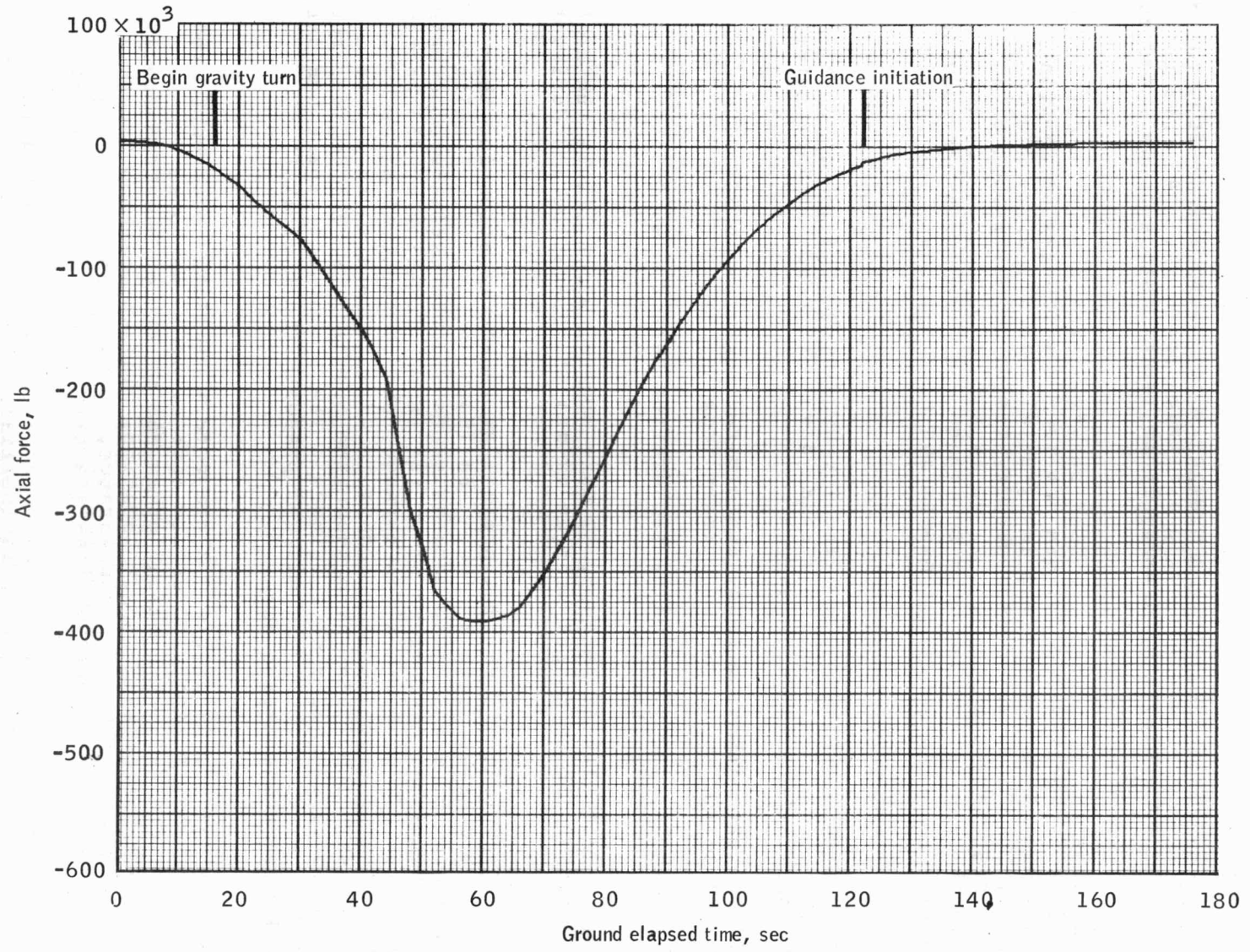

Figure 4.1.1-23.- Axial force versus ground elapsed time for shuttle BRM 3B.

#### 4.1.2 External Tank Disposal

4.1.2.1 External tank disposal summary.- Following launch from the WTR and SSME cutoff at a 90-nautical-mile altitude, there will be a suborbital jettison of the external tank, causing it to impact into a preselected zone in the South Pacific Ocean.

For the mission 3B ascent, the SSME cutoff is targeted to occur at an altitude of 90 nautical miles and the orbiter/ET will have an inertial flightpath angle of 0.1 degree and an inertial velocity of 25 278 fps. Approximately 5 seconds after SSME cutoff, the ET is jettisoned on a suborbital trajectory that results in an impact at 52 degrees south latitude in the Pacific Ocean. The ET impact and dispersions are contained within an ocean area free of land masses and with minimum ship traffic density projected for 1980.

4.1.2.2 Time line.- The time line for ET disposal begins at SSME cutoff, with the orbiter being in a heads-down position. At SSME cutoff plus 21 seconds, the ET is released.

At SSME cutoff plus 5 seconds, the orbiter performs an RCS -Z translation maneuver of 4 fps to separate from the ET.

At SSME cutoff plus 43 seconds, the orbiter performs an OMS burn to insert into a circular orbit.

At SSME cutoff plus 60 seconds, ET vent occurs, which allows the ET to pitch and tumble. No recontact problem exists at separation and during the OMS burn.

4.1.2.3 Impact location.- The nominal ET impact location for this mission is 52.1 degrees south latitude and 154.5 degrees west longitude. Insertion, drag, and atmospheric uncertainties and the estimate of debris breakup will result in deviations about the impact location of 360 nautical miles downrange, 277 nautical miles uprange, and 34 nautical miles crossrange. The uprange impact boundary is 47.6 degrees south latitude and 151.2 degrees west longitude. The downrange boundary is 57.3 degrees south latitude and 158.6 degrees west longitude. The crossrange impact boundary is  $\pm 0.4$  degree in width. Figure 4.1.2-1 presents the nominal ET groundtrack impact dispersion area.

4.1.2.4 Dispersion analysis.- A trajectory simulation was performed from SSME cutoff to ET impact to assess each error. The total ET dispersion impact area is the result of an RSS of all of the trajectory deviations about the nominal impact location, plus an addition for the estimate of debris breakup in the downrange, uprange, and crossrange directions. The ET impact dispersions are tabulated in table 4.1.2-I.

The mission 3B SSME cutoff occurs at an altitude of 89.9 nautical miles (referenced to a spherical Earth), an inertial flightpath angle of 0.1 degree, and an inertial velocity of 25 278 fps. The three uncertainties in the flightpath angle and velocity result in 76- and 104-nautical-mile downrange ET impact deviations, respectively, from the nominal impact location and are the main contributors to the downrange trajectory dispersions. The main contributors to the uprange ET impact dispersions are the flightpath angle (68 nautical miles) and the velocity (75 nautical miles).



For debris breakup, the primary breakup occurs at a 240 000-foot altitude. From this altitude, ET impact ballistic numbers ( $W/CDA$ ) of 5.0 and 51.2 with an L/D of  $\pm 0.2$  were used to estimate the downrange and uprange debris scatter. The downrange estimate of debris breakup is 207 nautical miles, and the uprange estimate of debris breakup is 148 nautical miles. The three RSS trajectory dispersions are 153 nautical miles downrange and 129 nautical miles uprange. It can be seen in table 4.1.2-I that the estimate of debris breakup exceeds the trajectory dispersions. The total impact dispersions for mission 3B are 360 nautical miles downrange, 277 nautical miles uprange, and  $\pm 17$  nautical miles crossrange. Figure 4.1.2-1 shows that the ET dispersions will not cause impact near a land mass or below 60 degrees south latitude. The impact area has a projected average ship traffic density of less than one ship per day projected for 1980 (see ref. 3).

TABLE 4.1.2-I.- EXTERNAL TANK DISPERSION FOR SHUTTLE BRM 3B

SSME cutoff conditions:

Flightpath angle . . . . .	0.1°
Velocity . . . . .	25 278 fps
Inclination . . . . .	104°
Altitude . . . . .	90 n.mi.
Latitude . . . . .	22.6° N.
Longitude . . . . .	125.4° W.
Range . . . . .	770 n.mi.
ET weight . . . . .	96 355 lb
Impact point:	
Latitude . . . . .	52.1° S.
Longitude . . . . .	154.5° W.
Surface range from pad . . . . .	5496 n.mi.

Error source	3-sigma error	Downrange, n.mi.	Uprange, n.mi.	Crossrange, n.mi.
-----	-----	-----	-----	-----
Separation altitude	±2434 ft	35	26	0
Separation velocity	11.63 fps -9.70	104	75	1
Separation flightpath angle	±0.28°	76	68	1
Separation range	±28 n.mi.	28	28	0
Drag	Random tumbling Planar tumbling	47	36	0
Atmosphere	3-sigma dense 3-sigma thin	47	55	0
Weight	±10 000 lb	20	22	0
Trajectory dispersion	3-sigma RSS	153	129	2
Estimate of debris breakup		207	148	15
Total dispersion		360	277	17

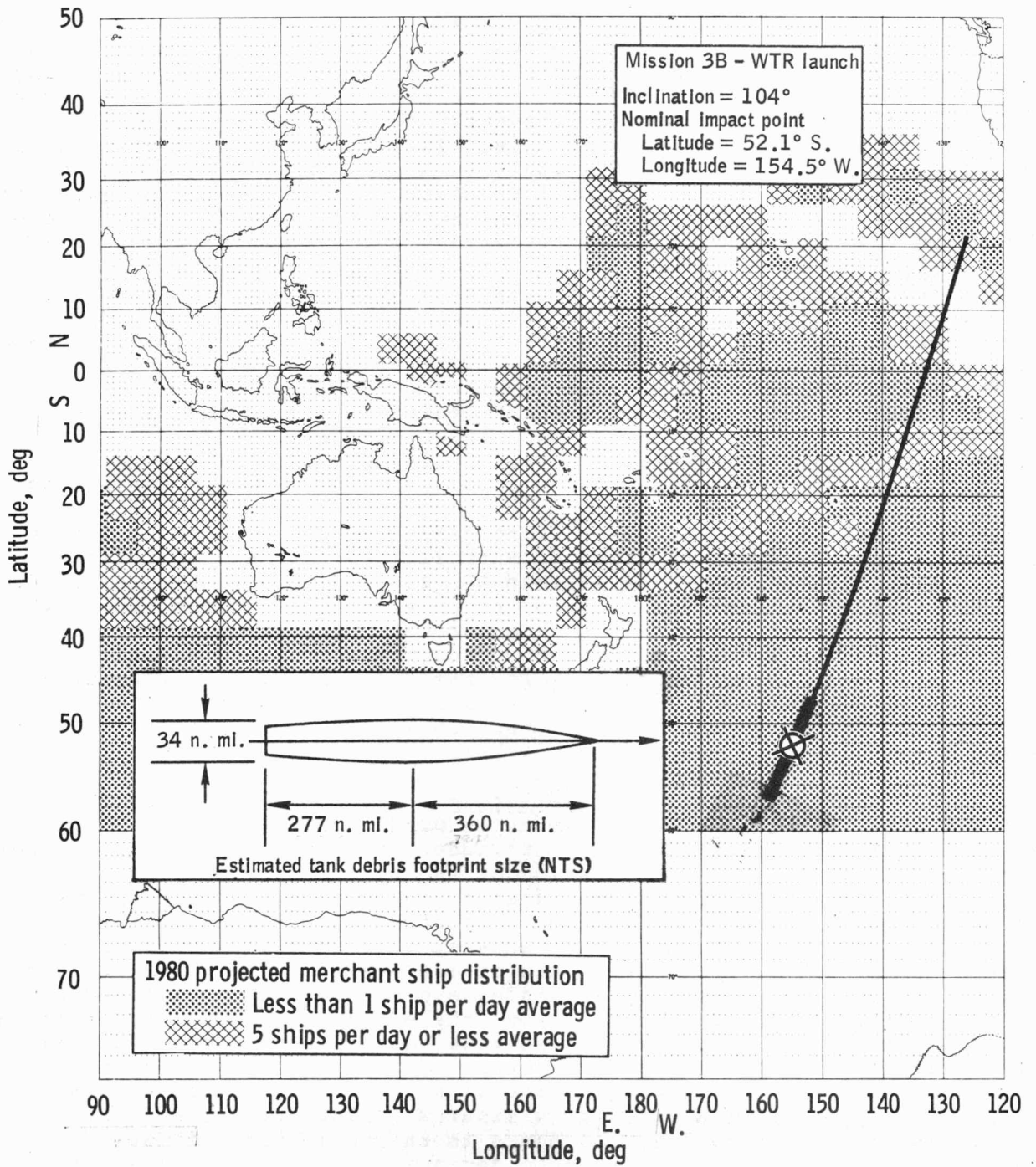

Figure 4.1.2-1.- Shuttle BRM 3B ET impact and dispersion area.

## 4.2 ONORBIT ACTIVITIES

### 4.2.1 3B Rendezvous

4.2.1.1 Nominal rendezvous profile.- Figure 4.2.1-1 shows the selected insertion point and nominal relative trajectory, together with the options available. Illustrated on this figure are the trajectories corresponding to differential altitudes of 10, 15, and 20 nautical miles at the transfer initiation point for a 130-degree transfer. For each of these trajectories, the relative elevation time history remains the same. As a consequence, the magnitude of the impulsive braking maneuver is a function of range for constant time-to-go to intercept. As shown on the figure, the trajectory selected is the one corresponding to a differential altitude of 15 nautical miles for a transfer angle of 130 degrees, which produces an impulsive braking maneuver of 42 fps. The point on the trajectory for establishing insertion conditions corresponds to a theoretical time to intercept (from insertion) of 18 minutes, or a transfer angle of 73.5 degrees, which is the final 73.5 degrees of the 130-degree transfer. As a result, the insertion of the orbiter relative to the payload is 6.7 nautical miles behind and 9.4 nautical miles below. This selection is obtained from the convergence of the constraints imposed; namely, the required search cone of the rendezvous sensor, the maximum time to rendezvous, and the thruster duty cycles during braking. In addition, this trajectory has been evaluated in digital and man-in-the-loop simulations.

For the nominal mission, the braking gates (range-range rate) were selected to provide a coast period of approximately 45 seconds between braking corrections, based on a minimum RCS acceleration capability of 0.4 ft/sec<sup>2</sup>. This coast time was included to provide a margin for excessive burn times for either range rate or angular rate corrections - due to dispersions, failed thrusters, or both. Additionally, the selection of braking gates was also based on limiting the 3-sigma delay in rendezvous time to be no greater than 7 minutes and arriving at a stationkeeping position (100 feet assumed) no later than 25 minutes after insertion. The braking gates are presented in table 4.2-I.

4.2.1.2 Nominal rendezvous time line.- For this mission, the OMS insertion burn is terminated at 12 minutes 0.547 second g.e.t., at which time the orbiter is in a heads-down attitude. A 2-minute delay is assumed between OMS termination and initiation of the required rendezvous activities to allow the onboard computer to be reconfigured for orbital operations and to allow the crew time to perform a quick status check of the critical orbiter systems. At 14 minutes zero seconds g.e.t., a 180-degree vehicle roll at an assumed rate of 3.0 deg/sec. (see sec. 5.2) is initiated to achieve a heads-up attitude, and the vehicle is pitched so that the tracking axis is oriented along the estimated line-of-sight to the target. Orbital rate attitude hold is then enabled at a local-vertical pitch at approximately -20 degrees (down). Concurrent with initiation of the roll maneuver is the sending of the signal to open the payload bay doors; the opening takes a total of 4 minutes. Also, concurrent with the initial opening of the payload bay doors is the deployment of the rendezvous sensor. By 16 minutes zero seconds g.e.t. (OMS termination plus 4 minutes), complete sensor deployment is achieved. Rendezvous sensor lock-on is achieved 1 minute later (17 minutes zero seconds g.e.t.), and data starts being received from the sensor after an additional minute, or at 18 minutes zero seconds g.e.t. The orbiter then maneuvers so that its attitude is along the true line-of-sight to the target. At this time,

inertial hold is enabled and approximately 30 seconds are provided to monitor relative rates. At a g.e.t. of approximately 19 minutes (7 minutes after OMS insertion), terminal control is initiated.

Nominally, the first braking maneuver occurs at 26 minutes 20 seconds g.e.t., and its purpose is to reduce the closing velocity to 40 fps. Subsequent maneuvers null inertial angular rates and reduce the closing velocity to 0.1 fps at 100 feet, in steps of 5-fps intervals at the selected range gates. At 33 minutes 37 seconds g.e.t., a 100-foot stationkeeping distance between the payload and orbiter is reached.

Figure 4.2-2 shows the relative motion between the payload and orbiter from insertion to rendezvous (100-foot range). The delta-V expended for the nominal 3B rendezvous is approximately 48.8 fps<sup>1</sup>. Of this, approximately 39.9 fps are used in reducing the closing velocity (range rate) to zero at 100 feet, and 8.9 fps are required to null the inertial angular rates. The nominal time to stationkeeping (100-foot range) was delayed 3 minutes 37 seconds because of braking; the delay resulted in an arrival time at 21 minutes 37 seconds after insertion.

Figure 4.2.1-3 shows the thrusting times associated with the nominal rendezvous. Although terminal control begins approximately 7 minutes after OMS termination, no maneuvering is required for the nominal mission until 14 minutes 20 seconds after insertion. The nominal duty cycle, which is defined as the ratio of the thrusting time to total time (referenced from the time of the initial braking maneuver), is approximately 9.6 percent. This parameter is a function of the braking gates employed, and it indicates the delay in rendezvous time that will be encountered; however, a margin must be incorporated to account for off-nominal situations. This margin can then be used for longer thrusting requirements or for brief periods between maneuvers for crew assessment of the situation. Figure 4.2.1-4 illustrates the range-range rate profile and the associated braking gates. The time history of the relative parameters - for example, range, range rate, and elevation angle - are shown on figure 4.2.1-5.

---

<sup>1</sup>This delta-V is the theoretical nominal and does not include dispersions or the results of man-in-the-loop simulations. The actual delta-V required is estimated to be 160 fps, but further dispersion analysis and simulation studies are required.

TABLE 4.2-I- ASSUMED BRAKING GATES FOR SHUTTLE BRM 3B RENDEZVOUS

Range, ft	RDOT minimum, fps	RDOT maximum, fps
50 635	85.00	95.00
45 615	80.00	90.00
40 855	75.00	85.00
36 365	70.00	80.00
32 135	65.00	75.00
28 160	60.00	70.00
24 455	55.00	65.00
21 010	50.00	60.00
17 830	50.00	55.00
14 910	45.00	50.00
12 255	40.00	45.00
9 860	35.00	40.00
7 730	30.00	35.00
5 860	30.00	30.00
4 255	25.00	25.00
2 910	20.00	20.00
1 830	15.00	15.00
1 010	10.00	10.00
455	5.00	5.00
160	.10	.10

LH

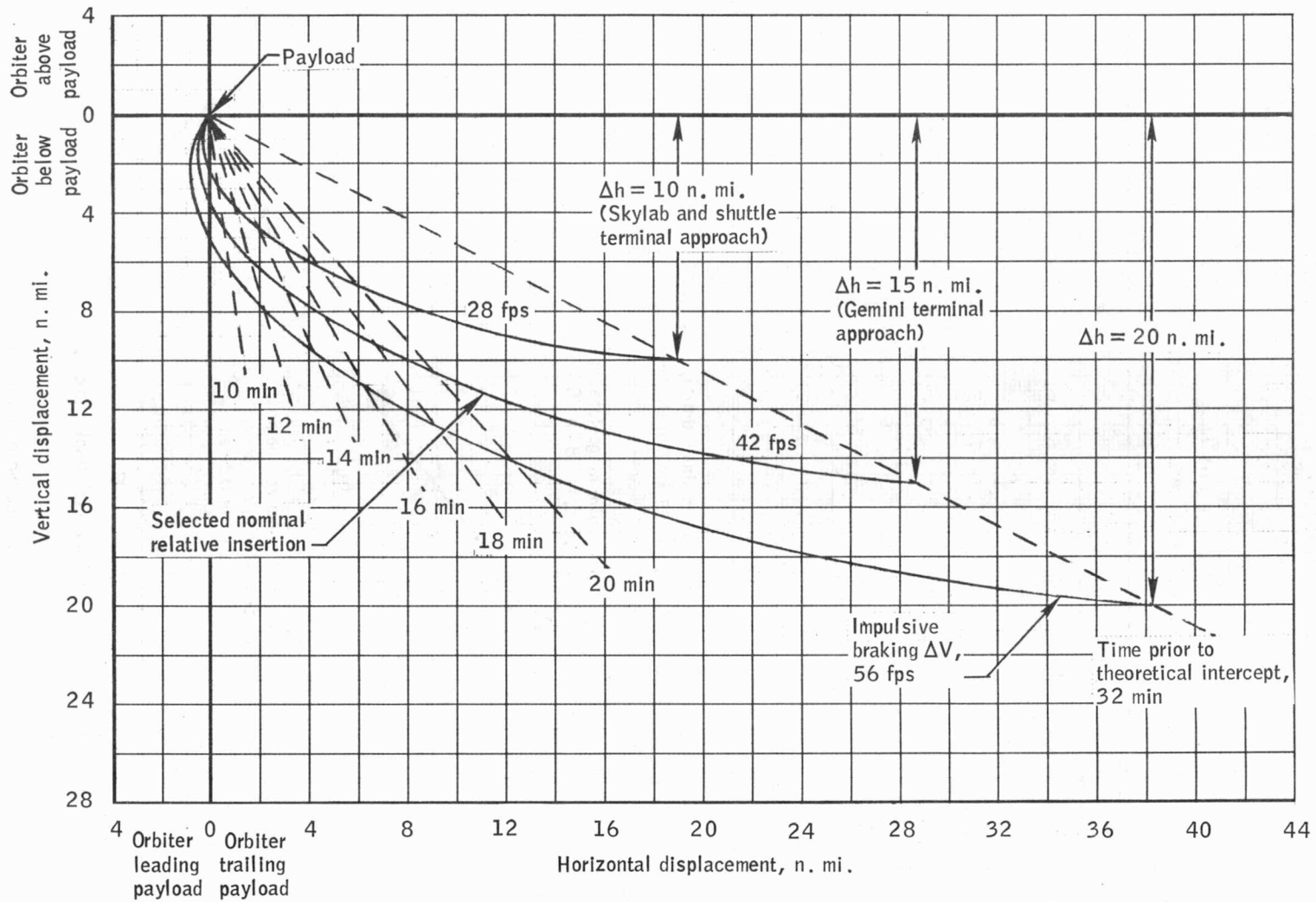

Figure 4.2.1-1.- Selection criteria for establishment of the shuttle BRM 3B insertion targets.



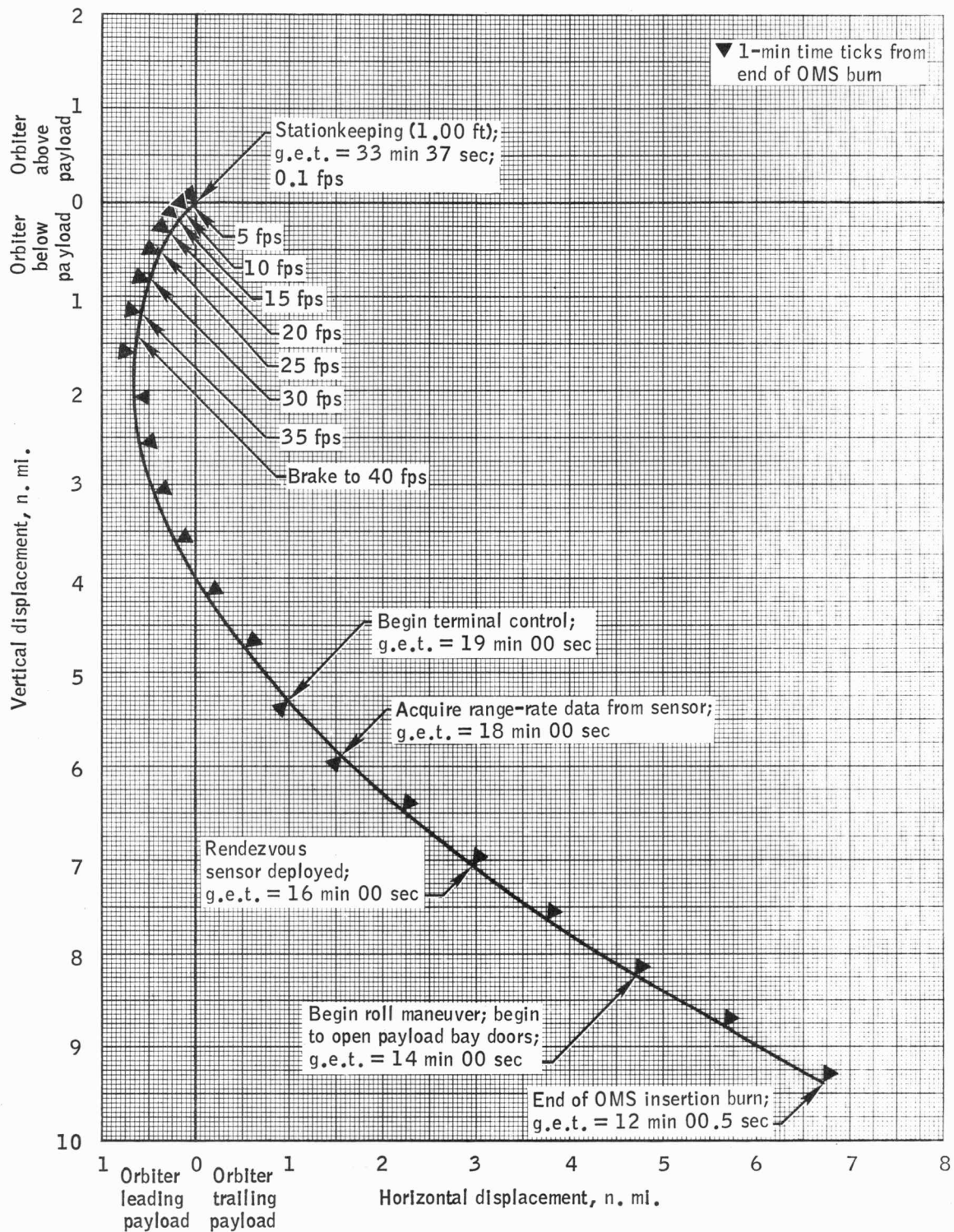

Figure 4.2.1-2.- Relative motion between orbiter and payload in a payload-centered curvilinear coordinate system for a nominal shuttle BRM 3B.



64

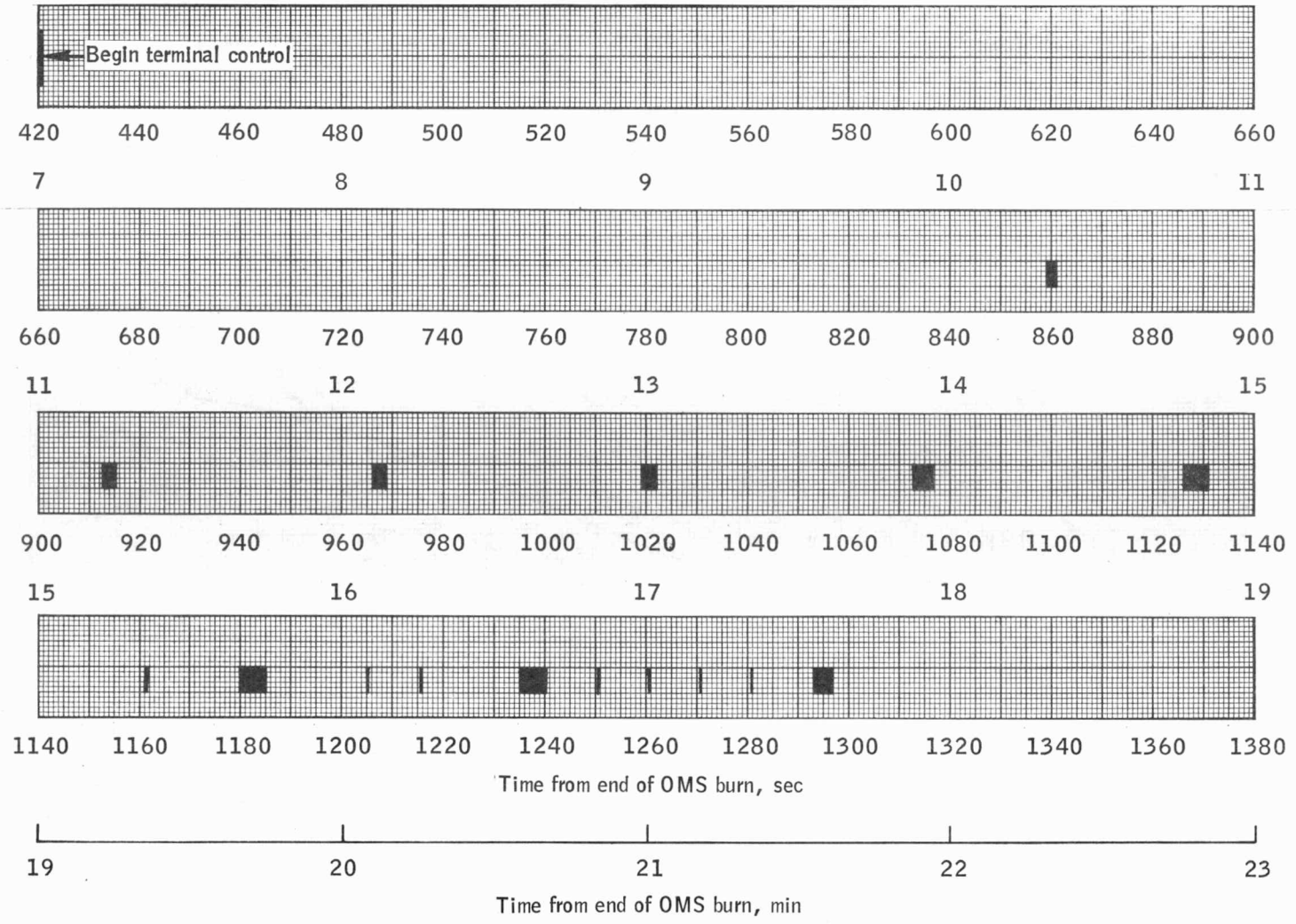

Figure 4.2.1-3.- Shuttle BRM 3B nominal RCS thrusting during braking.

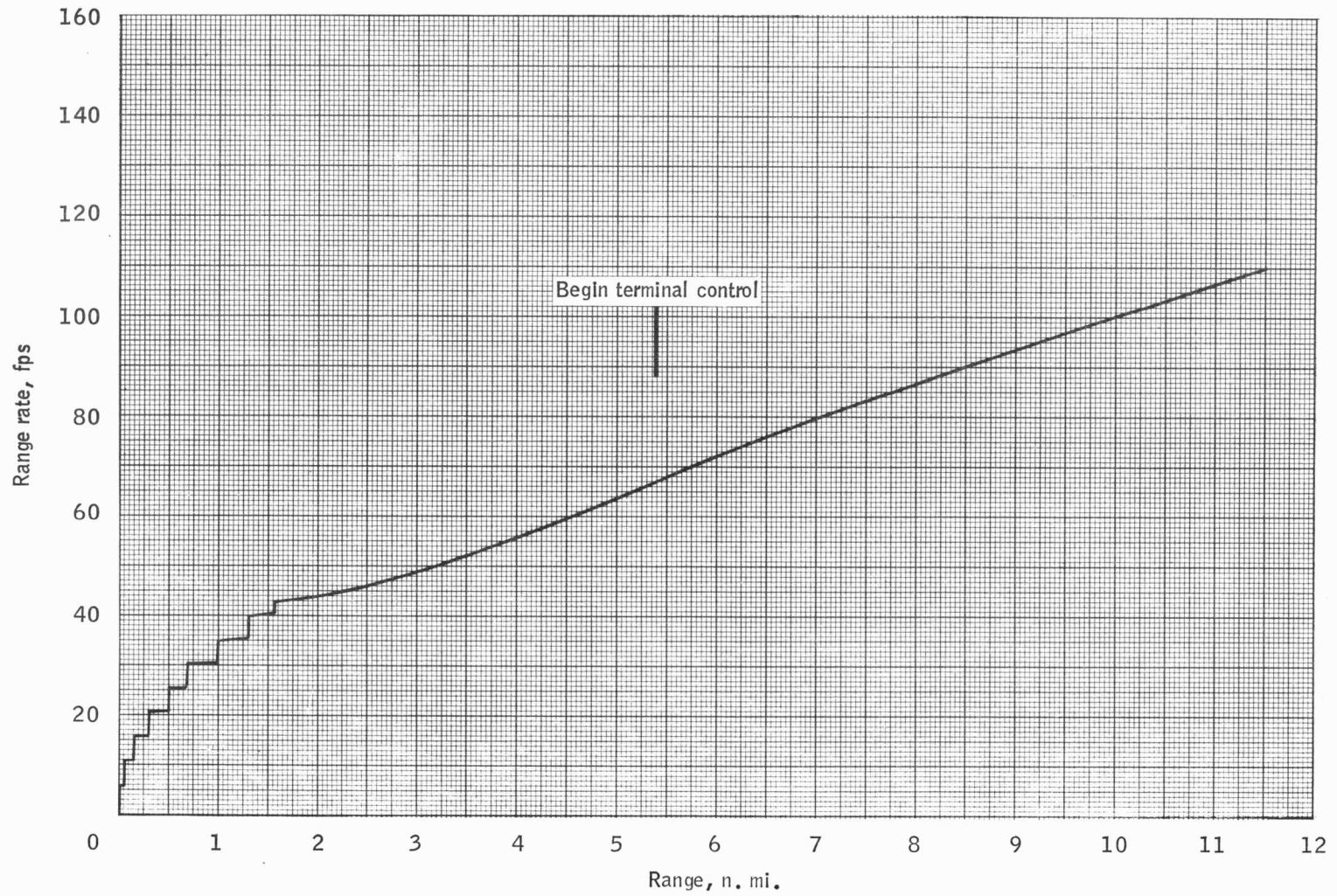

Figure 4.2.1-4.- Range rate versus range profile during braking phase of shuttle BRM 3B.

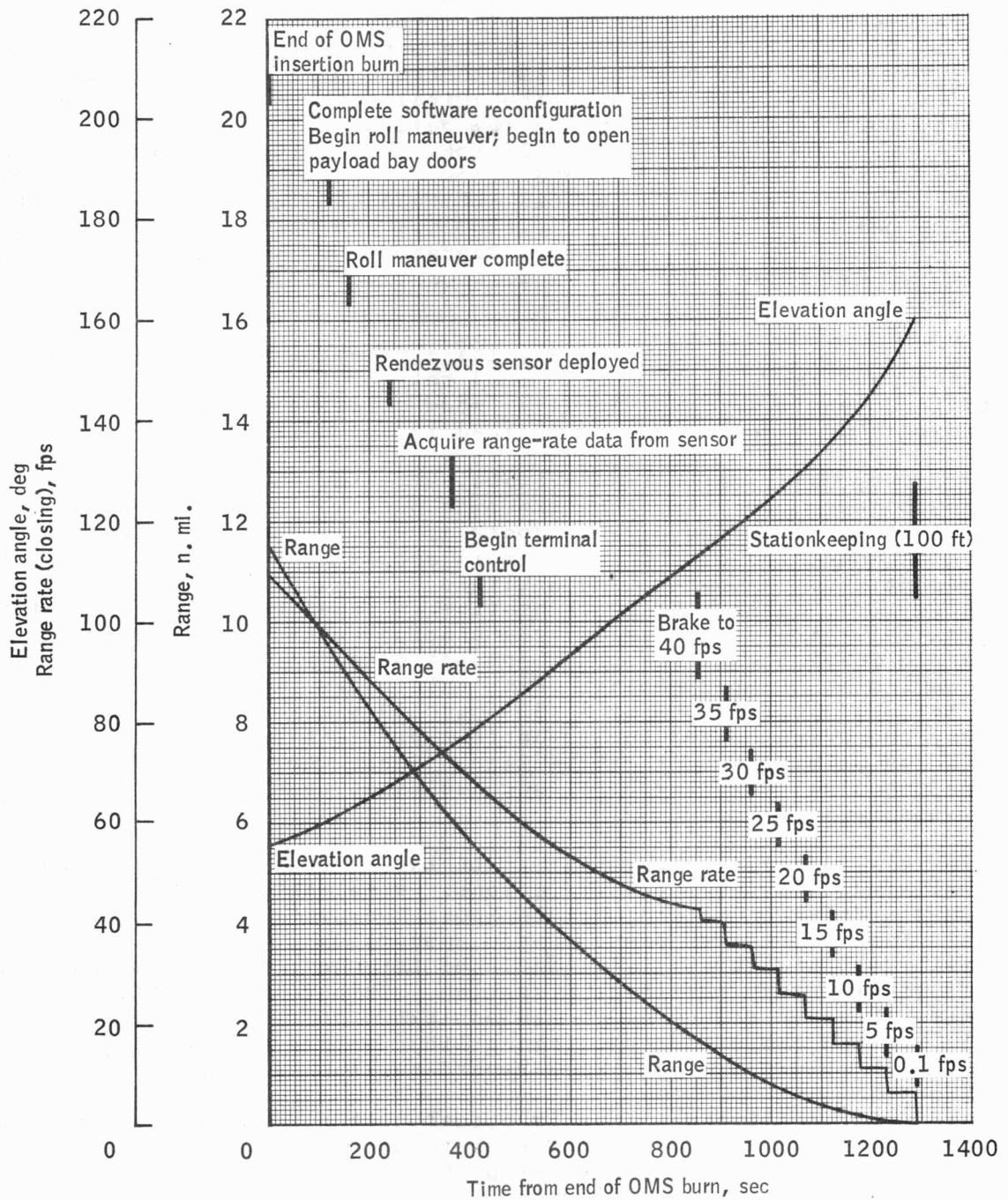

Figure 4.2.1-5.- Time history of nominal relative parameters between orbiter and payload for shuttle BRM 3B.

#### 4.2.2 Payload Retrieval

The payload retrieval phase is assumed to be the period between the orbiter arrival at a 100-foot range from the payload and the time the payload bay doors may close. During this interval, two separate activities must occur: first, the transition from the position and attitude of the orbiter at the end of the braking phase to the position and attitude required for retrieval and, second, the actual mechanics of grappling, passivating, positioning, and stowing the payload in the payload bay. For the transition phase, the time, translation, and attitude requirements are not defined at this time. These parameters, which must be determined by simulation, will depend on the payload attitude and location and the number of grappling points on the payload; visibility and control from the payload handler's station; and other factors. Therefore, to compensate for these uncertainties, all identified excess mission time has been allocated to the overall payload retrieval operations.

4.2.2.1 Ground rules, guidelines, and assumptions.- The guidelines, ground rules, and assumptions for payload retrieval operations are contained in appendix A. Additionally, more detailed assumptions relating to the manipulator time line are contained in appendix D.

4.2.2.2 Payload retrieval activities.- The payload retrieval activities commence when the stationkeeping position of 100 feet is reached. At this time, the payload doors are open, but the attitude is assumed to be something other than what is necessary for grappling. Since the payload attitude and grappling attitude are undefined, this plan reflects only that a 3-minute block of time is reserved for reorientation. The 3-sigma late time of arrival at the stationkeeping position is approximately 25 minutes. The time line presented is based on the nominal time for beginning stationkeeping. With this basis, the deorbit preparation could begin as early as 52 hours 10 minutes g.e.t. (when the payload bay doors are closed during deorbit preparation). This leaves more than 5 minutes of margin in the time line. Since the 3-sigma late stationkeeping time is 2 minutes 52 seconds later than nominal, some margin always exists.

Figures 4.2.2-1 and 4.2.2-2 illustrate the estimated geometry and time lines associated with retrieval operations. Note that the geometry on figure 4.2-1 indicates payload capture above and parallel to the orbiter horizontal plane. This was based on the assumption that an initial relative velocity of 0.4 fps is established between the payload and orbiter prior to initiating the retrieval operation. This relative velocity and the geometry shown in figure 4.2-1 are estimated to require the longest retrieval time and therefore result in a liberal time allowance for retrieval. Two points are made with regard to this illustration.

a. The orbiter attitude shown is normal to the relative velocity and is not necessarily normal to the inertial velocity; hence, the orbiter may or may not be yawed out of the orbital plane.

b. The relative velocity between the two vehicles will be kept to as low a value as can be determined on board. A relative velocity of 0.1 fps is assumed to be a reasonable value.

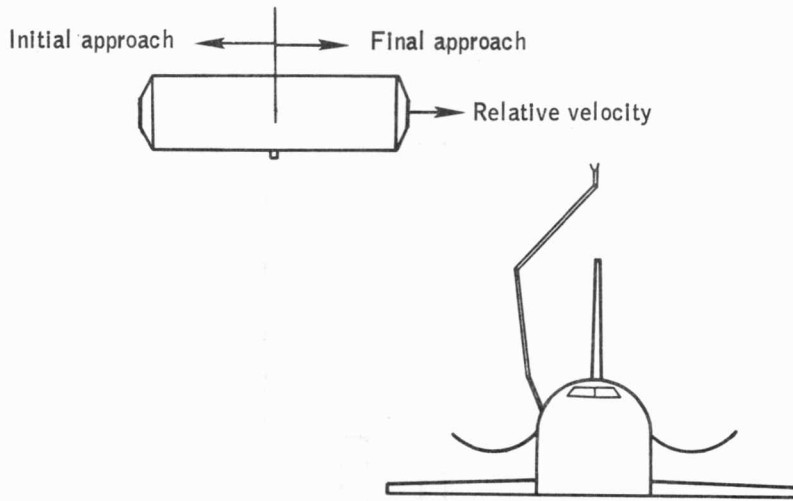

(a) Prior to retrieval.

Extracted from "Manipular Timeline for One Revolution Retrieval Mission," Systems Integration Section, Spacecraft Design Division

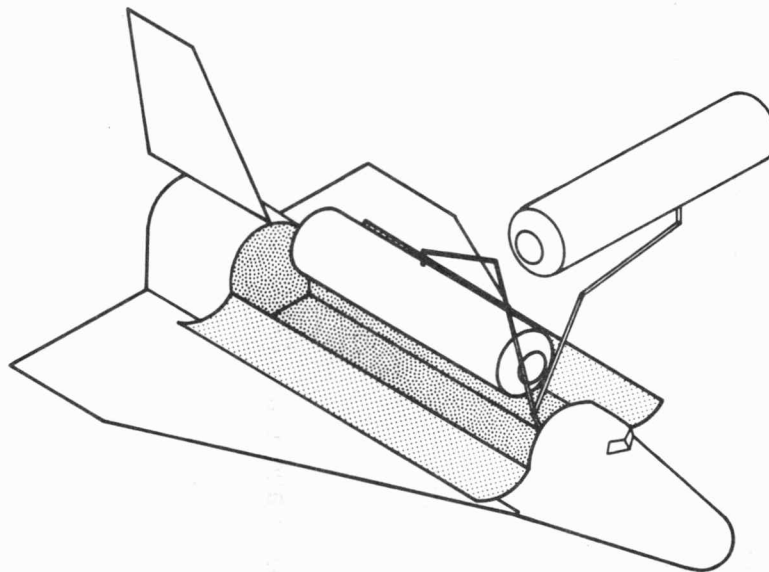

(b) Retrieval.

Figure 4.2.2-1.- Geometry for shuttle BRM 3B satellite retrieval.

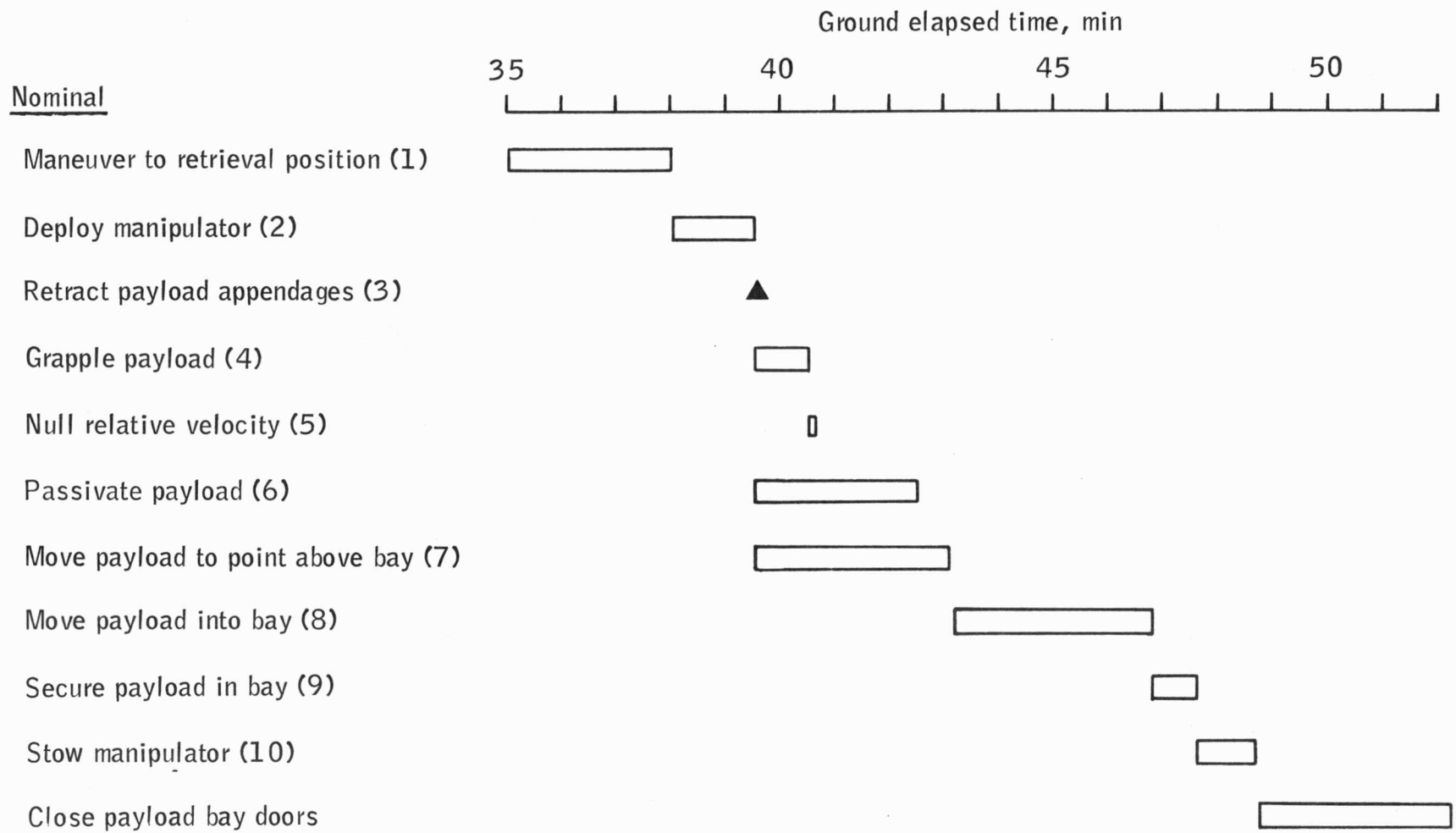

Figure 4.2.2-2.- Time line for shuttle BRM 3B satellite retrieval.



## 4.3 DESCENT

Basic data for key events are shown in the sequence of events table, 4-I, and in additional tables, 4.3-I through 4.3-III. Figures 4.3-1 through 4.3-19 are intended to present data from entry through the transition phase, although in most cases the plots extend through the TAEM and autoland phases to touchdown. Figures 4.3-20 through 4.3-32 contain expanded plots designed to present TAEM and autoland data. Autoland data are expanded further in figure 4.3-32, which contains data describing approximately the last 40 seconds before touchdown. Figure 4.3-33 contains a map overlaid with an estimate of the contours of sonic boom overpressure. The location and magnitude of the maximum overpressure can be seen in this figure.

### 4.3.1 Deorbit

The deorbit targeting is described in reference 4. The targeting provides an autonomous deorbit capability compatible with entry interface conditions acceptable for limiting the surface and backface temperatures, with the result that the lifetime of the thermal protection system is preserved. The targeting is such that if the primary propulsion configuration fails, then a predesignated backup propulsion configuration can complete the maneuver within the onboard capability and achieve nominal entry conditions. If the onboard delta-V does not allow nominal entry conditions for both the primary and backup configurations, then the processor is capable of determining targeting just within the onboard delta-V capability and compatible with a minimum degradation of nominal desired entry conditions. Whenever a degradation is incurred, a warning is displayed.

The targeting processor is capable of operating in either a time of ignition (TIG) fixed or a TIG-free mode.

The TIG-fixed mode is included to allow the crewman, mission rule, or mission discipline to initiate the deorbit maneuver at a predetermined time. In this case, for the delta-V available and with conformity to all constraints - including the predesignated backup propulsion capability - the targeting is designed for the most acceptable entry interface possible.

The TIG-free mode is employed when the crewman, time line permitting, desires a minimum delta-V solution for the primary propulsion configuration, subject to the condition that the predesignated backup propulsion must also be able to achieve nominal acceptable entry interface conditions within the delta-V available. The minimum delta-V solution is achieved by selecting a true anomaly at the start of the maneuver such that the thrust vector and the radius vector at the midpoint of the burn are perpendicular. Linear tangent steering is used to control the thrust direction.

In the event that the delta-V on board exceeds that required to achieve the nominal entry conditions, including that which would be required by the predesignated backup propulsion, the entry interface positional target is rotated so that the desired amount of propellant is expended during the burn. This will normally correspond to using as much of the usable



propellant as possible, such that a just-sufficient amount for the backup propulsion capability exists after rotating the targets out of plane. This is included in the iterative process. Near propellant depletion usually makes far more acceptable c.g. conditions. The entry interface positional target is rotated so that the entry crossrange is reduced.

The characteristics of the deorbit maneuver are contained in table 4-I. For the initial thrust direction, the yaw is -21.19 degrees and the pitch is -143.75 degrees. The resultant orbit, referenced to a spherical Earth, has apogee and perigee altitudes of 107.12 nautical miles and 18.65 nautical miles, respectively.

#### 4.3.2 Entry Interface Targeting

Entry interface targeting is the development of the desirable combinations of velocity, flightpath angle, and range-to-the-target (V-Y-R) at the entry interface. This targeting consists of two interrelated target lines that define the desired entry flightpath angle and corresponding range-to-the-target as a function of entry velocity. Selection of these target lines involves a trade-off between thermal protection system (TPS) surface temperatures, TPS backface temperatures, and maneuver margins allowed for dispersions while the deorbit delta-V requirement is maintained within acceptable limits. This trade-off, and hence definition of the target lines, for a particular mission depends on the orbit inclination, postdeorbit apogee altitude, orbiter entry weight and longitudinal center-of-gravity (c.g.) position, the entry groundtrack during the early part of entry, and the deorbit delta-V capability. The entry groundtrack influences the entry targeting primarily because the atmosphere essentially follows the approximate oblate spheroid shape of the Earth. This results in the effective flightpath angle relative to the atmosphere changing by a significant amount as the orbiter traverses different latitudes at high speeds during the early part of entry.

The orbiter TPS is being designed on the basis of mission 3B since this is the most critical mission for the TPS, primarily because of the worst combination of orbit inclination, orbiter weight, and orbit altitude. The orbiter longitudinal c.g. position is projected to be 66.5 percent for mission 3B entry; however, an aft c.g. of 67.5 percent was used for the entry phase of this reference mission. This results in a discontinuity in the c.g. position at the entry interface; however, this aft c.g. location was chosen because this c.g. position is critical for TPS design and because this location is consistent with the TPS design trajectories. To maximize TPS reuse, missions less critical to the TPS than mission 3B will be targeted such that the TPS surface and backface temperatures are lower than those for mission 3B. The approach taken to develop the target lines for mission 3B is to develop the desired targeting and entry profile for a postdeorbit apogee altitude, the same as for the TPS design trajectory. The drag acceleration for this profile is then used to expand the entry targeting definition over a range of entry velocities.

TPS surface temperatures are analyzed at four critical points on the orbiter in defining the entry targeting. These points are illustrated in figure 4.3-1 as control points 1 through 4 and are located on the orbiter nose, body flap, wing leading edge, and outboard elevon tip, respectively. Figures 4.3-2 and 4.3-3 present the effects of V-Y-R on the orbiter nose maximum temperature, control point 1, and on the reference heat load, respectively. The velocity for these two figures, when coupled with the

corresponding flightpath angles, results in a constant postdeorbit apogee altitude of 145 nautical miles. The angle-of-attack for mission 3B is the  $40^\circ/30^\circ$  ramped alpha profile developed for the TPS design trajectory. With this profile, control point 1 is the only control point for which the surface temperature is directly related to the  $V-\gamma$  at the entry interface and the resulting pullout. The maximum temperatures for the other three control points occur after pullout, on the constant heating rate phase of the entry profile. This later part of entry is controlled primarily by the guidance constants selected to control the entry profile shape and by the entry range. The wing-leading-edge heating is a strong function of alpha; therefore, the peak wing-leading-edge surface temperature occurs after pitchover to the lower alpha has begun. The surface temperature on the orbiter aft sections is determined largely by the transition from laminar to turbulent flow in this region.

A flightpath angle of  $-1.01$  degrees with an entry range of 4364 nautical miles was selected as the desired  $\gamma-R$  combination for the postdeorbit apogee altitude of 145 nautical miles. This selection is compatible with the TPS design trajectory, and targeting is based on the trade-off between surface temperature, backface temperature, trajectory dispersion correction capability, and deorbit delta-V requirement. The drag-velocity profile resulting from this entry targeting was then used to define the  $V-\gamma-R$  target lines as a function of entry speed presented in figure 4.3-4. Postdeorbit apogee altitudes of less than approximately 145 nautical miles result in backface temperatures less than those for the TPS design trajectory. The minimum surface temperatures are the same for entries targeted along the  $V-\gamma-R$  target lines.

### 4.3.3 Entry Trajectory

The orbiter entry trajectory is controlled with use of the baseline entry guidance, reference 5. The fundamental entry profile shape and angle-of-attack profile are the same as those for the TPS design trajectory. The erasable memory data for the entry guidance are presented in table 4.3-I. The orbiter for mission 3B has an entry weight of 188 037 pounds and a longitudinal gravity c.g. location of 66.5 percent. However, as discussed in the Entry Interface Targeting section, an aft c.g. of 67.5 percent was used for the entry phase of this mission, with a weight of 185 675 pounds. The aft c.g. location, coupled with the requirement to maintain the elevon surface temperature at less than 2500° F, results in large body flap deflections and, hence, body flap temperatures that exceed 2500° F. The body flap and elevon deflection schedules were selected to be consistent with HRSI reuse and the policy of accepting control surface temperatures in excess of 2500° F on the body flap rather than the elevon.

Figures 4.3-5 through 4.3-19 present pertinent entry trajectory parameters; table 4.3-II presents the significant event times; and table 4.3-III presents a TPS summary.

### 4.3.4 Terminal Flight

The terminal area flight consists of the terminal area energy management (TAEM) and the autoland phases. Terminal area energy management begins with selection of a nominal constant equivalent airspeed (EAS), proceeds to control the energy as a function of range, and terminates with the onset of the autoland phase, which maintains a glidepath and ground velocity. Autoland also controls the flare and deceleration to touchdown and performs active braking to a stop.

The terminal area phase of the trajectory begins at a velocity of 1500 fps and an altitude of about 68 000 feet. It terminates with a controlled landing on the target runway. The primary trajectory control mode for this mission phase is automatic; however, independent ground and onboard techniques exist that follow the same basic trajectory as the automatic mode.

The subphases of TAEM are the acquisition phase, the heading alignment phase, and the pre-final-approach phase. The subphases of autoland are capture, steep glide slope, deceleration phase, and landing and rollout. These subphases are defined in the following paragraphs.

a. Acquisition phase. The acquisition phase is designed to guide the orbiter to the final approach entry point so that it arrives with the energy margin needed to satisfy the final approach energy requirements. The guidance accomplishes this by determining a predicted groundtrack range to the runway threshold and a line-of-sight heading to a point tangent to a cylinder (called the heading alignment cylinder) that is itself tangential to the final approach plane at the nominal entry point. The energy is controlled by modulating the speed brake as a function of the energy/range derivative. If the required energy/range rate is considerably different from the nominal, the EAS is also changed appropriately.

Targeting the heading for a tangent point on the heading alignment cylinder rather than directly to the final approach entry point allows the

guidance time to establish the correct heading angle and dynamic pressure desired for the final approach. The heading alignment cylinder turn radius is chosen to nominally produce a 30-degree bank angle.

Once the guidance determines the line-of-sight heading to the tangent point, it commands the orbiter to turn to this desired heading and fly to the tangent point. Since the line-of-sight to the heading alignment cylinder is continually being updated, the heading angle is corrected to the current line-of-sight heading rather than to the initial heading to the target.

The guidance is also continually calculating the predicted groundtrack range to the threshold and using this range to determine the desired energy dissipation rate. A set of energy-range functions (fig. 4.3-28) has been developed to permit the guidance to control the energy dissipation rate as a function of predicted groundtrack range. If the actual energy-range relationship is excessive and the energy cannot be dissipated through the modulation of the flared rudder and dynamic pressure within the predicted range to the target, the groundtrack is lengthened by performing a turn away from the target until the predicted groundtrack is extended to a length that will again allow the energy to be controlled by the flared rudder and dynamic pressure modulation. Should the energy-range relationship be low and the vehicle not have sufficient energy to achieve the nominal target while flying the minimum flightpath angle, an alternate target (minimum entry point) is selected that can be reached with a lower energy-range function. The energy-range functions for the current baseline are given in figure 4.3-28. The acquisition phase is terminated when the conditions are met for initiating either the heading alignment phase or the pre-final-approach phase. These phases are described below.

b. Heading alignment phase. The heading alignment phase is initiated when the range to the tangent point on the heading alignment cylinder becomes less than 4000 feet, and is designed to establish a bank angle that will put the orbiter on the heading alignment cylinder turn radius when the tangent point is reached. This phase is terminated when the conditions for initiating the pre-final-approach phase are established.

c. Pre-final-approach phase. The pre-final-approach phase is initiated when the heading angle is within 20 degrees of the runway heading and the range-to-go to the tangent point with the final approach plane (nominal entry point, NEP) is less than arc length to the NEP. This prefinal phase is designed to achieve the autoland glide slope and the EAS that is desired while on the glide slope and to control the heading angle so that it will coincide with the desired final approach heading. During this phase, the angle of attack is modulated to achieve the desired final approach glide slope, while the rudder flare is modulated to achieve the desired EAS at autoland initiation. The phase is terminated by initiation of the autoland capture mode when the altitude and crossrange errors with respect to the steep glide slope are less than 1000 feet.

d. Capture phase. The capture phase modulates pitch angle and flared rudder to converge within the proper position and velocity window for initiation of the steep glide slope phase.

e. Steep glide slope phase. The steep glide slope phase is designed to maintain a heading along the extended runway centerline and a predetermined glide slope, which is chosen to allow operation on the front side of the L/D curve with margin for wind compensation. In the steep glide slope phase, the pitch angle is modulated to control the angle of

glide and the rudder flare is modulated to control the ground speed. This phase is terminated at the initiation of the first flare maneuver.

f. Deceleration phase. The deceleration phase consists of a two-flare trajectory. During the first flare, which is initiated at relatively high altitude, the flightpath is changed from a steep approach to a shallow path; and after a decelerating glide, the second flare, which terminates at touchdown, is executed. This two-flare approach splits the task of reducing the altitude rate to the touchdown value into two efforts, with the result that more margin for timing and execution errors is allowed and some ability to compensate for off-nominal positions and speeds is provided.

g. Landing and rollout phase. Completion of the second flare maneuver results in a touchdown about 2000 feet beyond the runway threshold. After the landing is completed, active braking continues to decelerate the orbiter to a stop.

TABLE 4.3-I.- ERASABLE MEMORY LOAD FOR SHUTTLE BRM 3B ENTRY GUIDANCE

Shaping gains					
AK	3.5	ALFM	27.0	VA	20500
VA1	23000	VA2	29500	VB1	18500
AK1	-4.3	VS1	25766.1973	VSAT	25766.1973
RHPDN	1.0	GS1	0.02	GS2	0.017
GS3	0.025	GS4	0.03		
Transition targeting					
DF	19.09	EEF4	2000000	ETRAN	45.3E6
RPT1	17.24	VQ	5000	VTRAN	9000
Alpha profile					
VALP1	7500	VALP2	8500	VALP3	18000
VALP4	19000	VALP5	22000	VALP6	23000
CALP1	5.385	CALP2	0.003077	CALP3	0.0
CALP4	-77.44	CALP5	0.02522	CALP6	-0.148E-5
CALP7	30.0	CALP8	0.0	CALP9	0.0
CALP10	350.4	CALP11	-0.0358	CALP12	0.1E-5
CALP13	-16.25	CALP14	0.0025	CALP15	0.0
CALP16	-646.55	CALP17	0.05975	CALP18	-0.13E-5
CALP19	40.0	CALP20	0.0	CALP21	0.0

TABLE 4.3-I. - ERASABLE MEMORY LOAD FOR SHUTTLE BRM 3B ENTRY GUIDANCE - Concluded

CD correction

CD1	112.0	CD2	-0.04	CD3	69.88
CD4	-0.02541	CD5	-1108.5	CD6	0.1326
CD7	0.0	CD8	0.0	CD9	0.008
CD10	-0.074	CD11	-226.0	CD12	0.008
CD13	-1150.0	CD14	0.05	CD15	0.0
CD16	0.0	CD17	-3000000	CD18	0.001



TABLE 4.3-II.-SUMMARY OF SHUTTLE BRM 3B ENTRY TRAJECTORY EVENTS

Event	Time from entry interface, min:sec	Geodetic altitude, ft	Mach no.	Heading from north, deg	Predicted range to threshold, n.mi.	Geodetic latitude, deg	Longitude, deg
Entry interface	00:00	400 001	19.8	-33.87	4369	63.02 N.	02.74 E.
Begin S-band communications blackout	03:12	319 847	27.9	-56.03	3582	72.77 N.	22.64 W.
0.05 g, initiate temperature control phase	04:22	290 192	29.6	-70.74	3296	74.99 N.	38.53 W.
Exit TACAN and S-band communications blackout	17:38	179 012	12.9	175.77	681	45.51 N.	122.39 W.
Initiate transition phase	20:18	157 148	8.9	155.30	375	40.52 N.	122.39 W.
TACAN acquisition	21:23	151 187	7.5	150.06	284	39.15 N.	121.41 W.
Initiate terminal area	27:13	68 039	1.5	173.72	34	35.03 N.	120.47 W.
Landing	31:56	0	0	-44.0	Not applicable	34.73 N.	120.57 W.

TABLE 4.3-III.- THERMAL PROTECTION SYSTEM (TPS) SUMMARY FOR SHUTTLE BRM 3B

Panel no.	Inflight maximums			Surface insulation tps		Weight/unit weight summaries		
	Panel area, ft <sup>2</sup>	Heating rate, Btu/ft <sup>2</sup> /sec	Surface temperature, °F		Total heat load, Btu/ft <sup>2</sup>	Insulation, lb/n.d.	Thickness, in.	Total weights, lb/n.d.
1	24.00	29.72	2467.35	RCC	22861.62	174.11 / 7.25	2.35	174.11/7.25
2	362.00	15.57	2030.40	HRSI	12054.03	924.14 / 2.55	2.60	924.14/2.55
3	113.00	13.00	1920.78	HRSI	9353.43	261.24 / 2.31	2.32	261.24/2.31
4	446.00	12.09	1877.70	HRSI	8181.42	899.82 / 2.02	1.97	899.82/2.02
5	559.00	8.81	1700.29	HRSI	6119.73	920.97 / 1.65	1.54	920.97/1.65
6	403.00	6.41	1534.97	HRSI	4663.86	680.13 / 1.69	1.58	680.13/1.69
7	158.00	15.26	2018.21	RCC	12811.72	1709.59 / 10.82	1.22	1709.59/10.82
8	435.00	17.59	2107.71	HRSI	14703.61	1250.64 / 2.88	2.98	1250.64/2.88
9	412.00	15.32	2020.33	HRSI	11591.31	1086.26 / 2.64	2.70	1086.26/2.64
10	641.00	11.64	1855.61	HRSI	7704.06	1424.37 / 2.22	2.21	1424.37/2.22
11	165.00	16.57	2069.57	HRSI	9374.12	409.68 / 2.48	2.52	409.68/2.48
12	360.00	7.45	1611.11	HRSI	4653.59	666.55 / 1.91	1.84	666.55/1.91
13	275.00	3.93	1304.79	HRSI	3203.22	386.95 / 1.41	1.25	386.95/1.41
14	473.00	2.71	1148.24	LRSI	2120.13	354.57 / .75	.55	354.57/.75
15	1631.00	.26	455.48	LRSI	224.81	777.50 / .48	.20	777.50/.48
16	764.00	.31	479.17	LRSI	164.41	364.20 / .48	.20	364.20/.48
17	114.00	1.21	856.25	LRSI	631.52	57.27 / .50	.23	57.27/.50
18	631.00	.71	690.00	LRSI	446.37	300.80 / .48	.20	300.80/.48
19	155.00	15.55	2029.79	HRSI	9616.57	398.87 / 2.57	2.62	398.87/2.57
20	673.00	2.30	1084.21	LRSI	1923.90	518.67 / .77	.58	518.67/.77
21	242.00	1.49	924.15	LRSI	886.80	159.26 / .66	.43	159.26/.66
22	610.00	1.02	798.52	LRSI	786.88	336.52 / .55	.30	336.52/.55
23	1132.00	.55	622.16	LRSI	431.83	539.62 / .48	.20	539.62/.48
24	372.00	.60	641.43	LRSI	462.84	184.27 / .50	.22	184.27/.50
25	82.00	39.73	2687.71	HRSI	23700.23	282.41 / 3.44	3.65	282.41/3.44
						-----		-----
CONTROL POINT SURFACE		CP1(NOSE)	CP2(BODY FLAP)	CP3(WING LEADING EDGE)	15088.52	CP4(ELEVON)		15088.52
TEMPERATURE MAXIMUMS		.25626992+04	.28122921+04	.27169850+04		.25118919+04		
RELATIVE VELOCITY		.21062029+05	.19341536+05	.18960173+05		.16154710+05		

NOTE: See Figure 4.3-1 for critical surface temperature control points and panel locations on the orbiter.

79

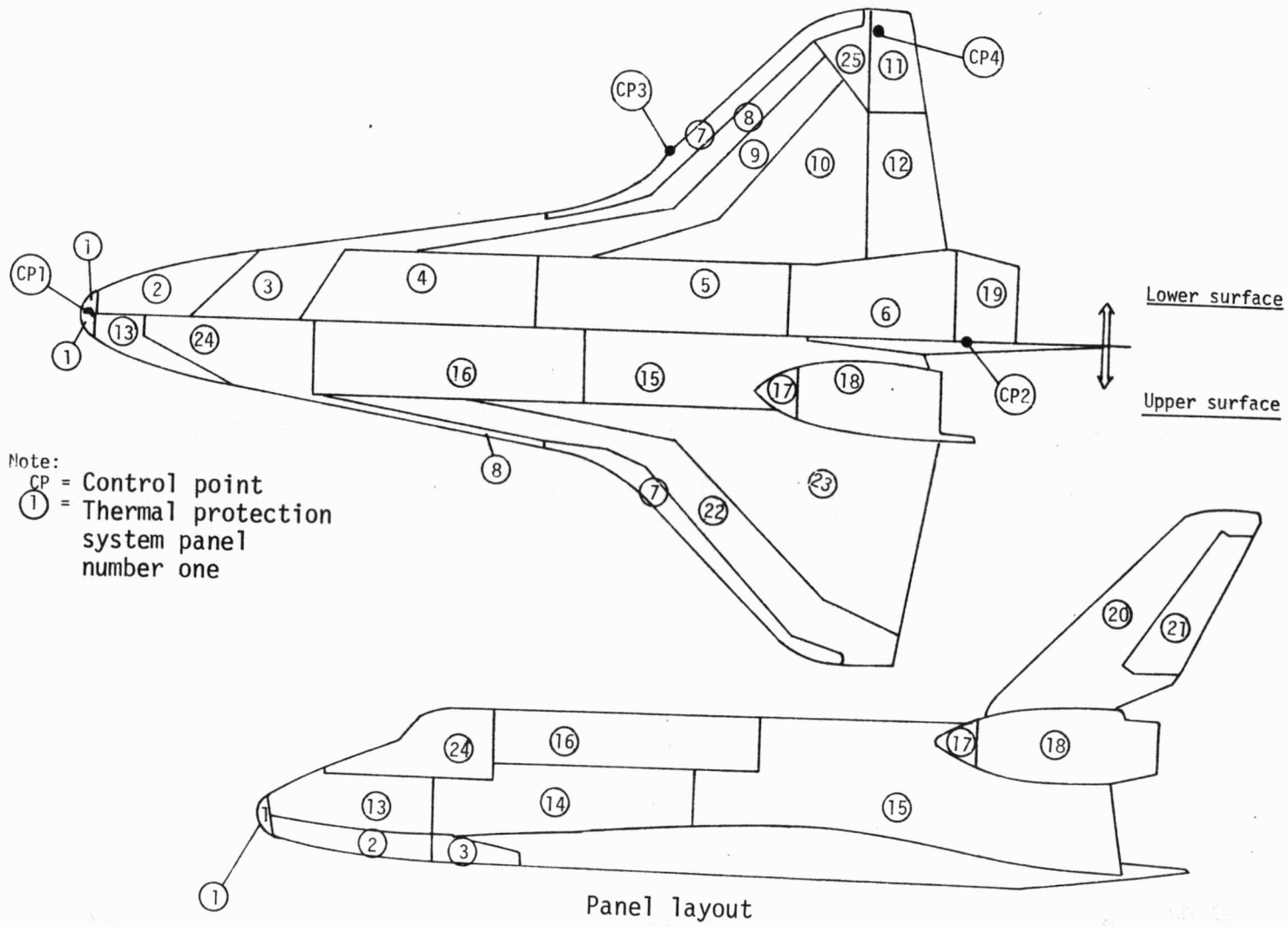

Figure 4.3-1. - Surface temperature critical control points and various panel locations for the shuttle orbiter.

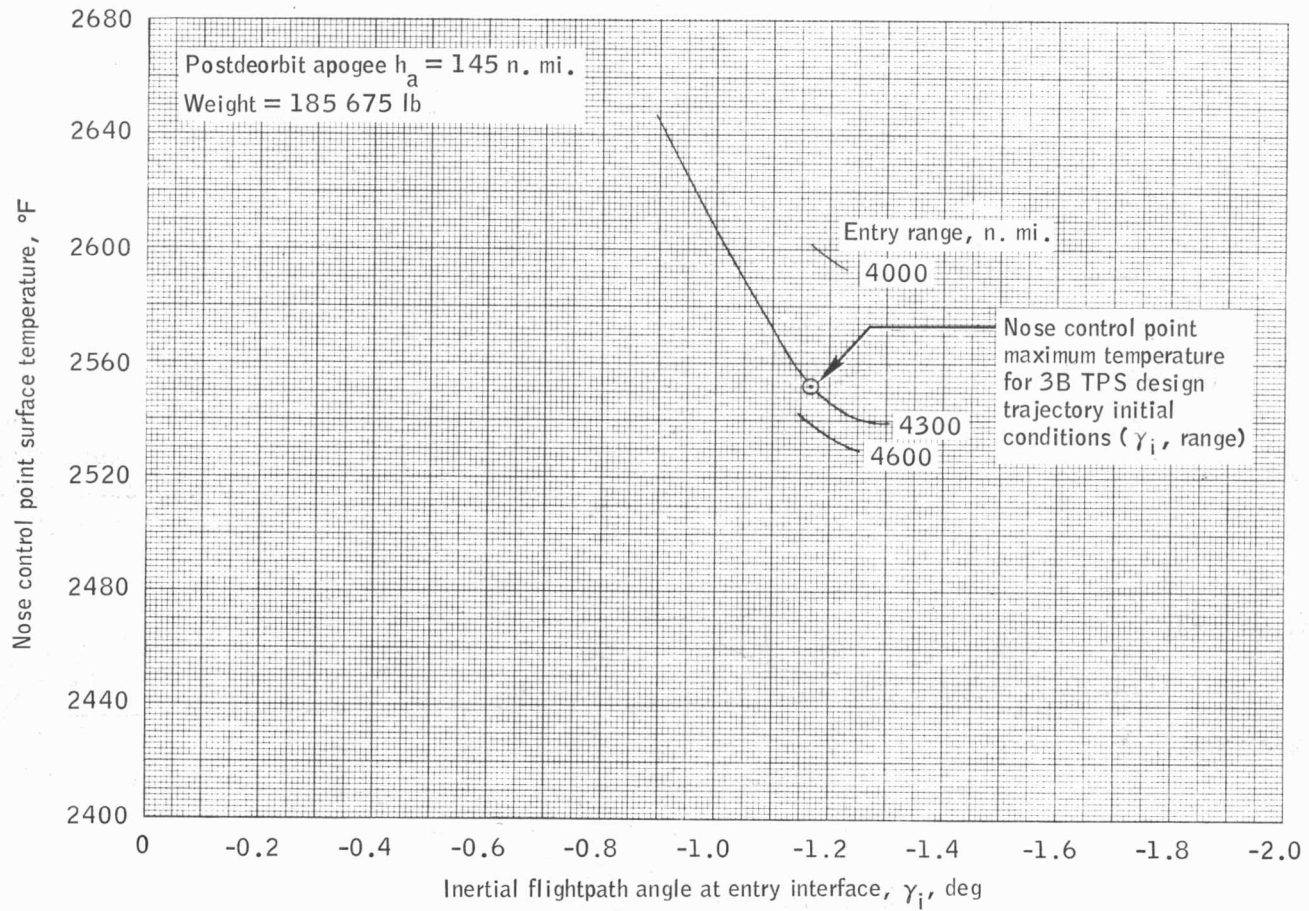

Figure 4.3-2.- Maximum nose control point surface temperature versus inertial flightpath angles for various entry ranges for shuttle BRM 3B.

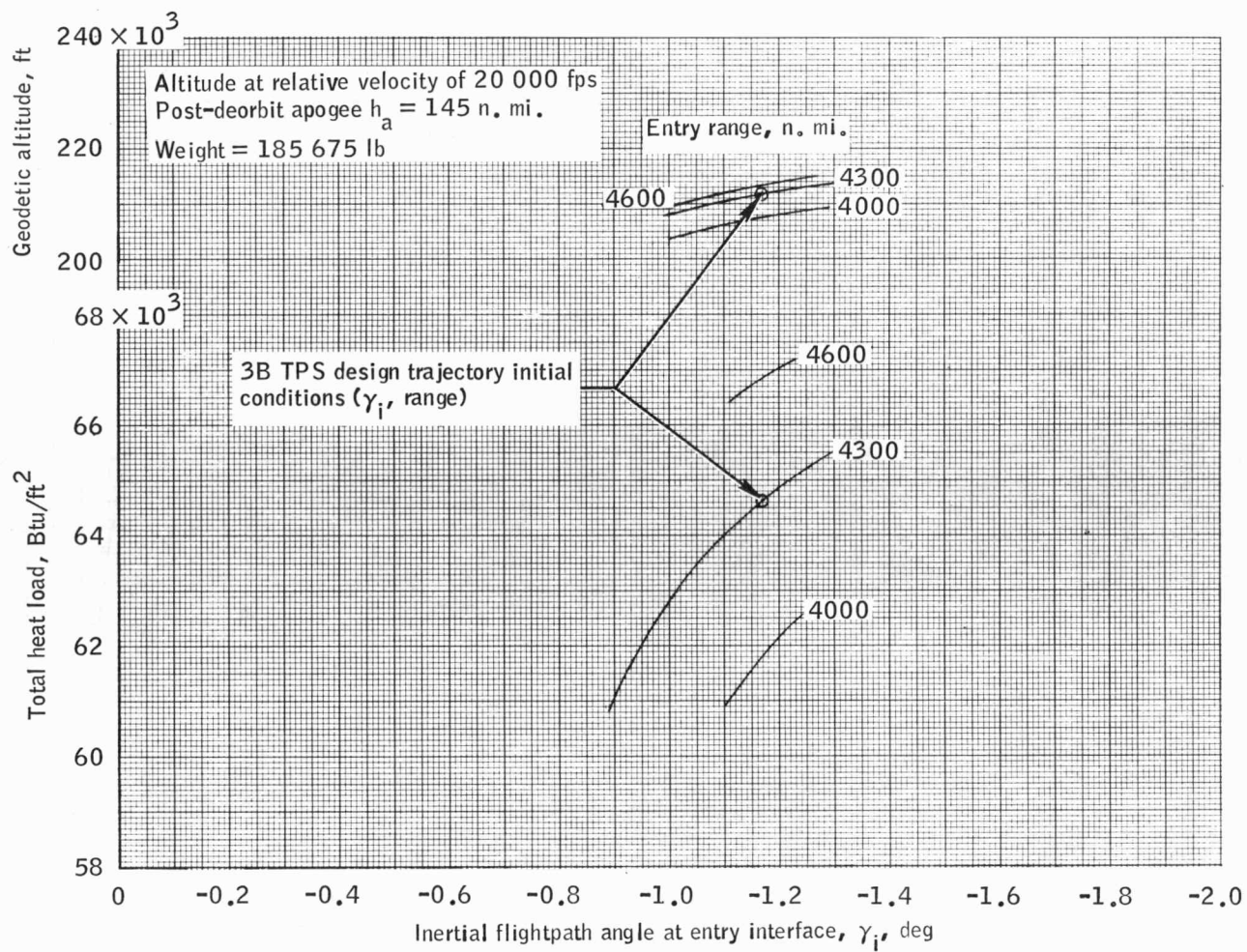

Figure 4.3-3.- Total heat load and altitude versus inertial flightpath angle for various entry ranges from 400 000 feet for shuttle BRM 3B.

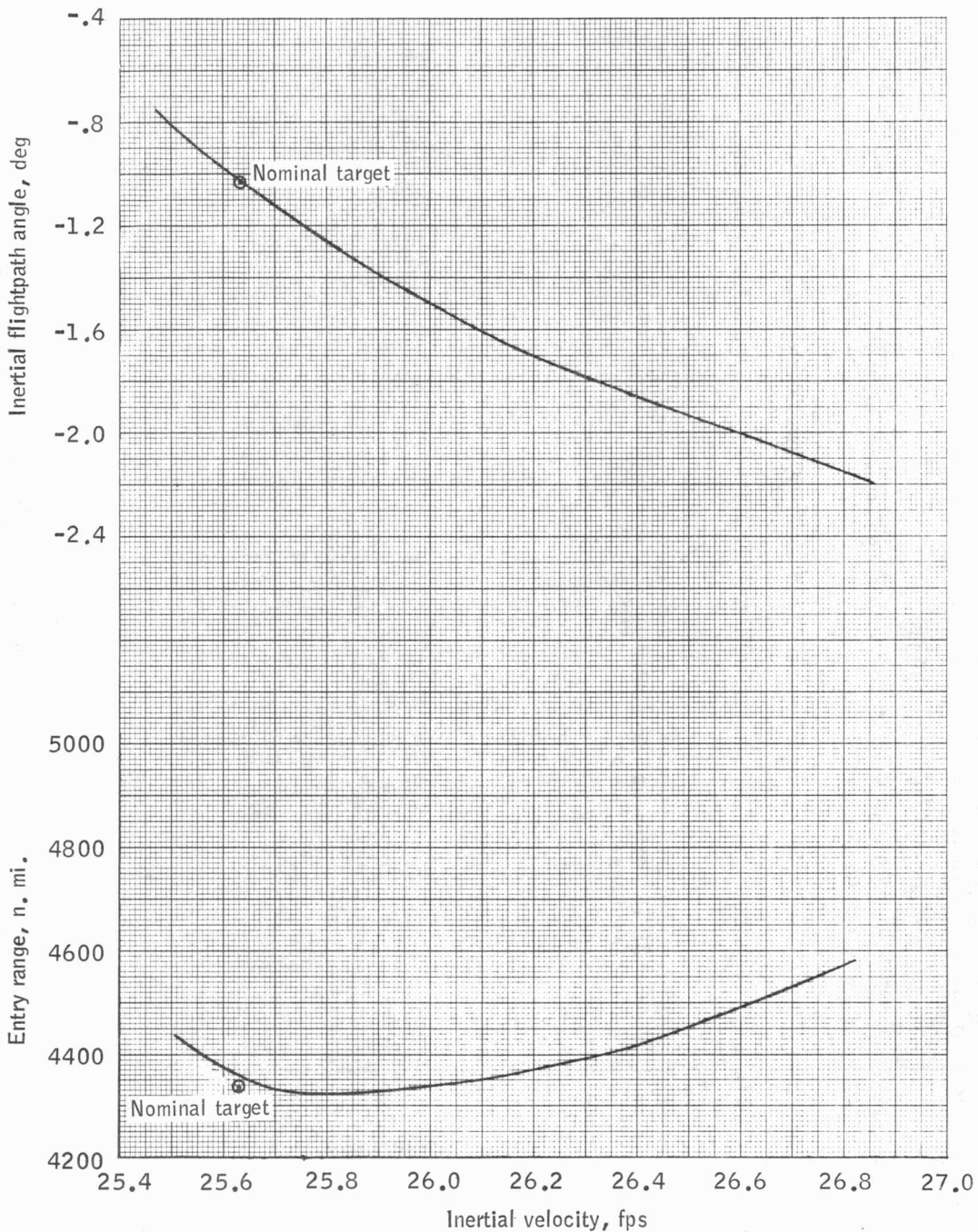

Figure 4.3-4.- Inertial velocity, inertial flightpath angle, and range target lines for shuttle BRM 3B at entry interface.



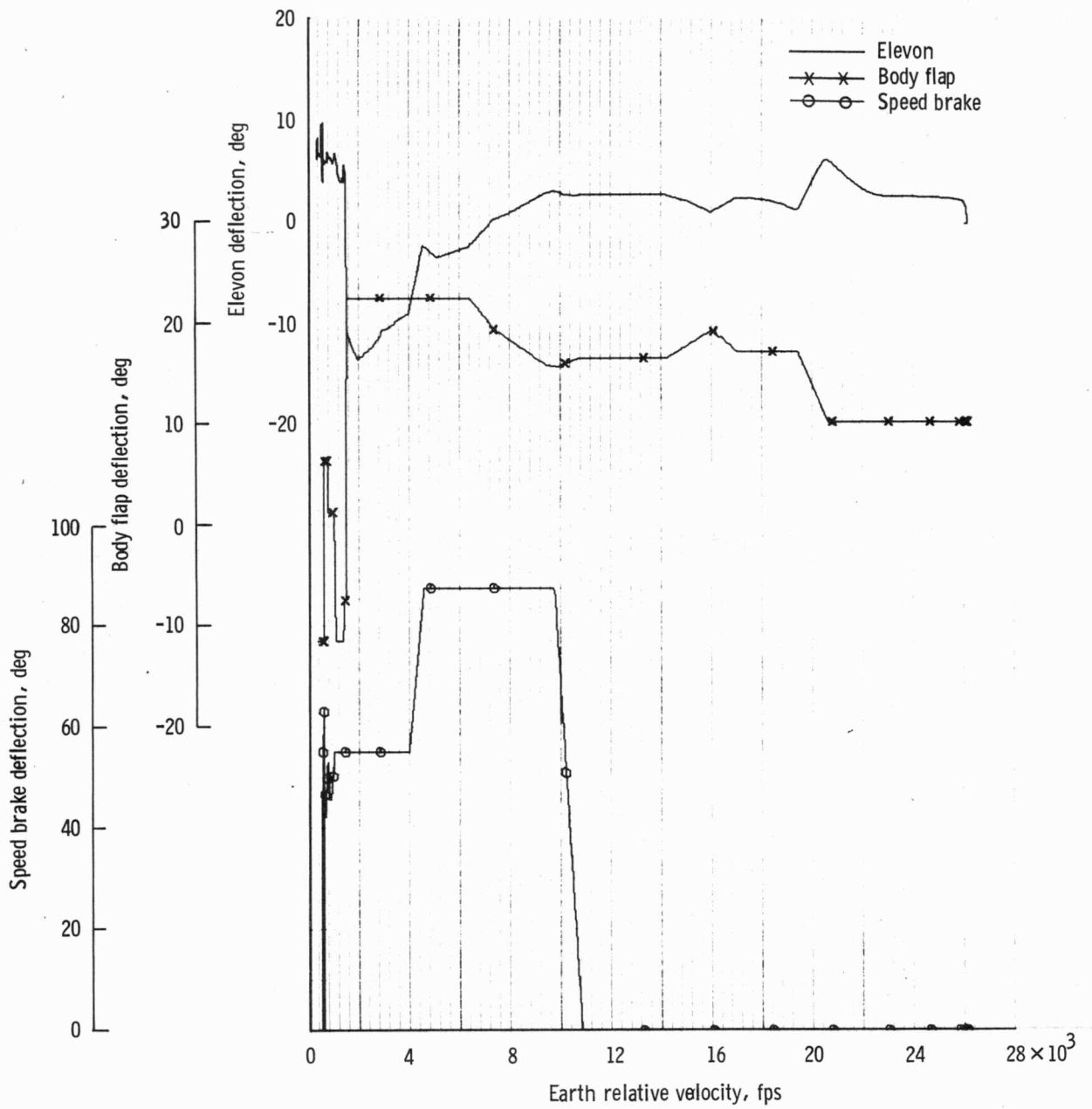

Figure 4.3-5. - Elevon, body flap, and speed brake deflection versus relative velocity for shuttle BRM 3B.

- 1 Entry interface
- 2 Begin S-band blackout
- 3 .05g
- 4 Exit S-band blackout
- 5 Acquire TACAN
- 6 Initiate TAEM



Figure 4.3-6.- Shuttle BRM 3B groundtrack from entry interface to landing.

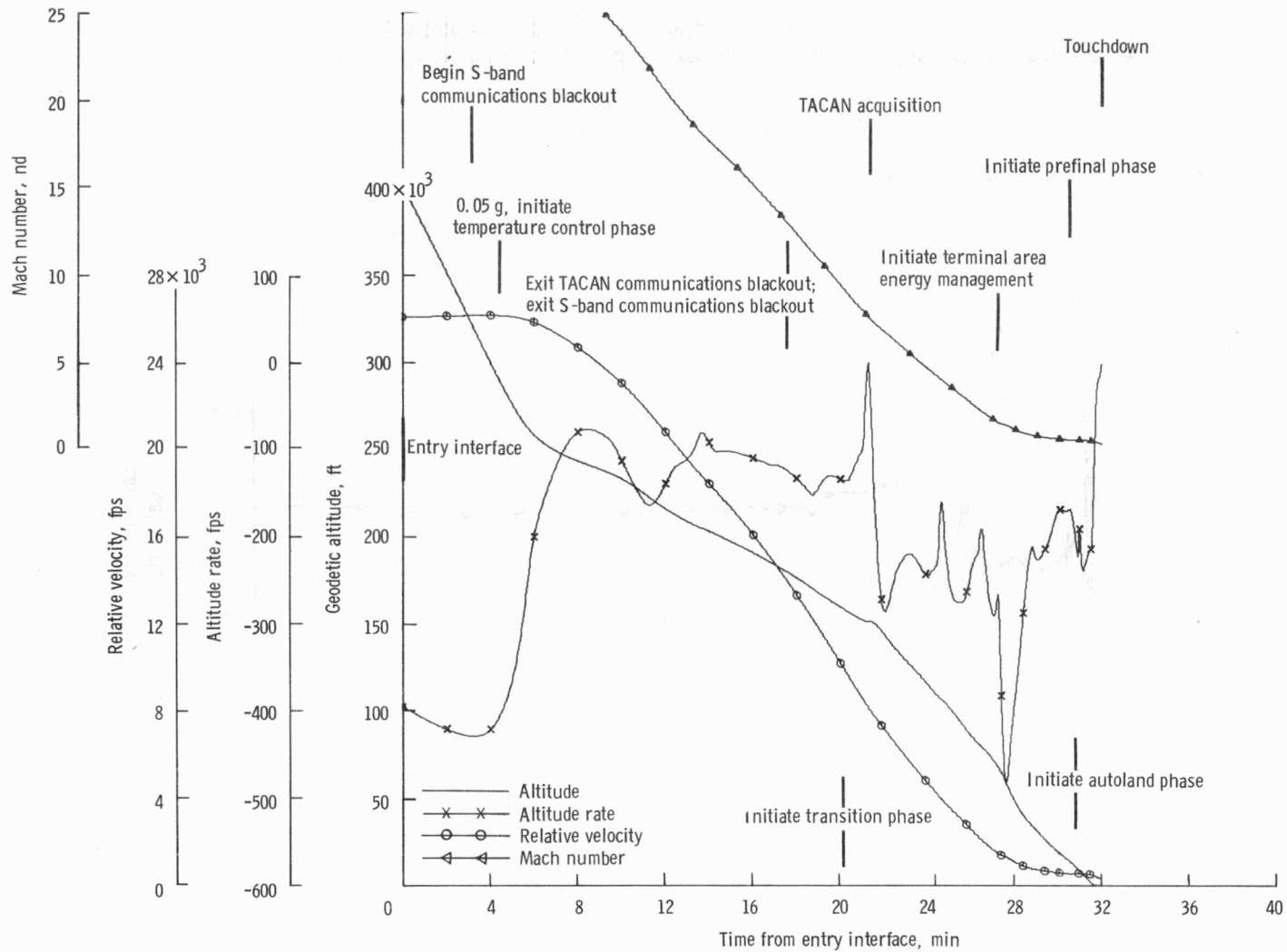

Figure 4.3-7. - Altitude, altitude rate, relative velocity, and mach number versus time from entry interface for shuttle BRM 3B.

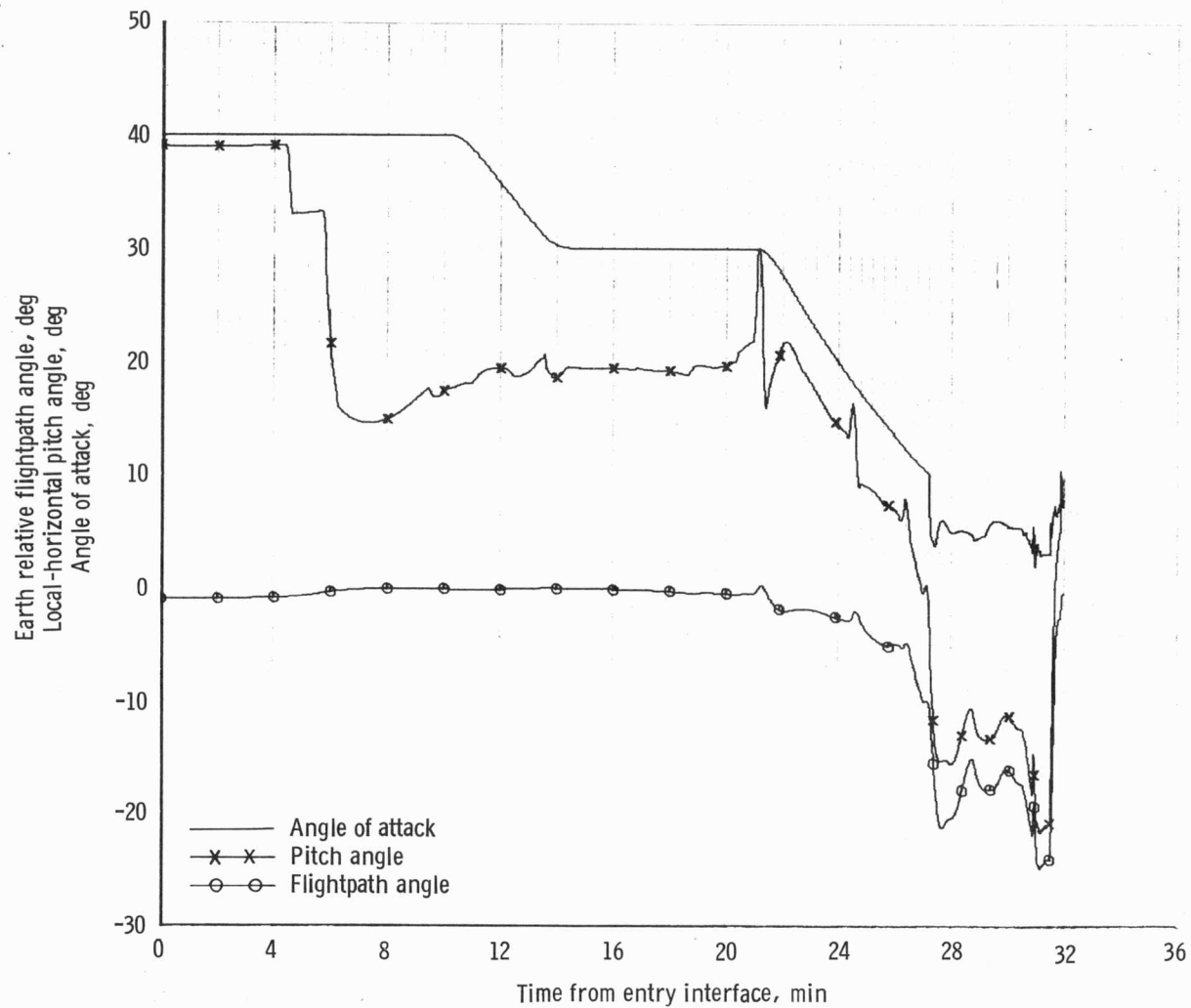

Figure 4.3-8. - Angle of attack, local-horizontal pitch angle, and Earth relative flightpath angle versus time from entry interface for shuttle BRM 3B.

73

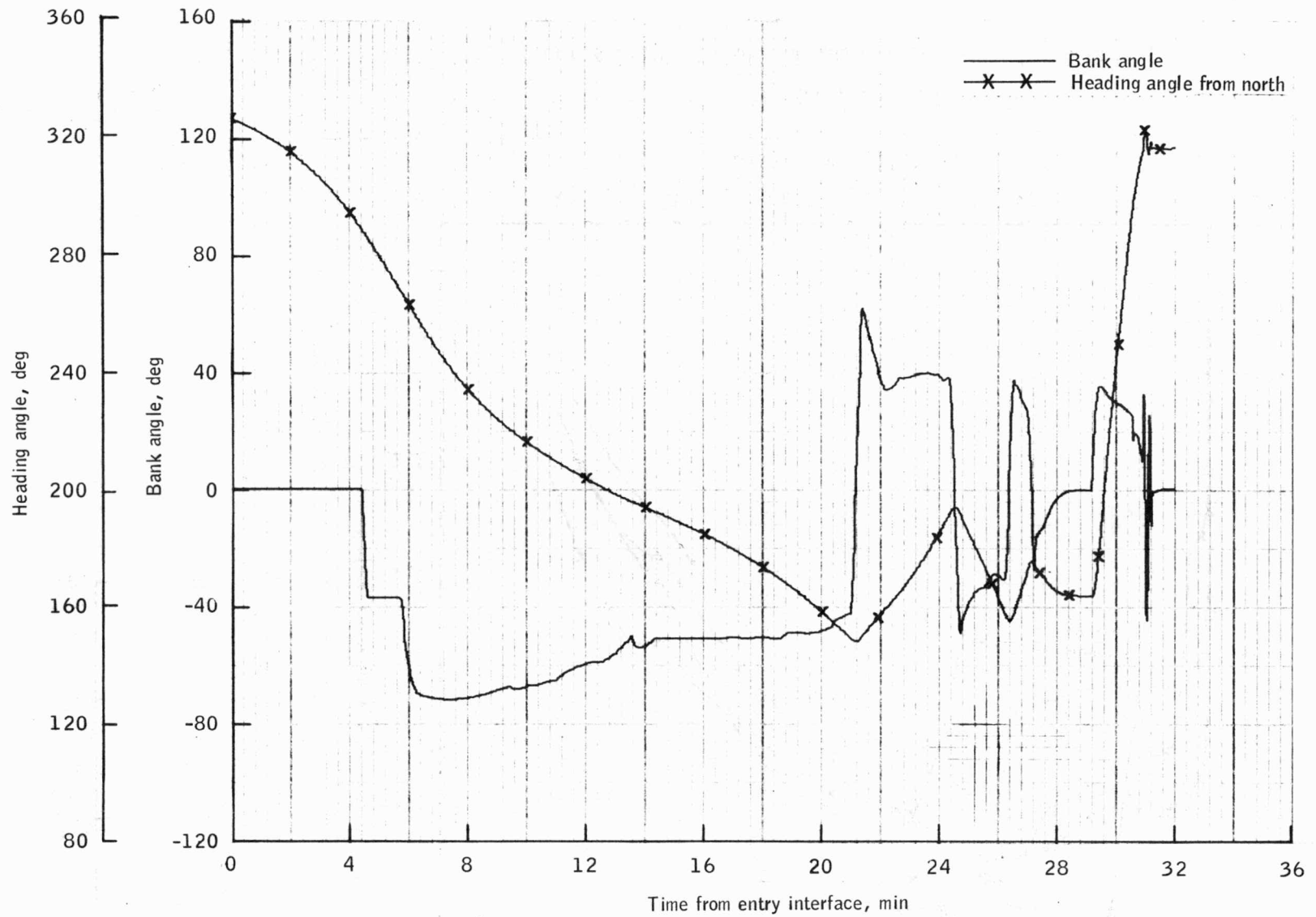
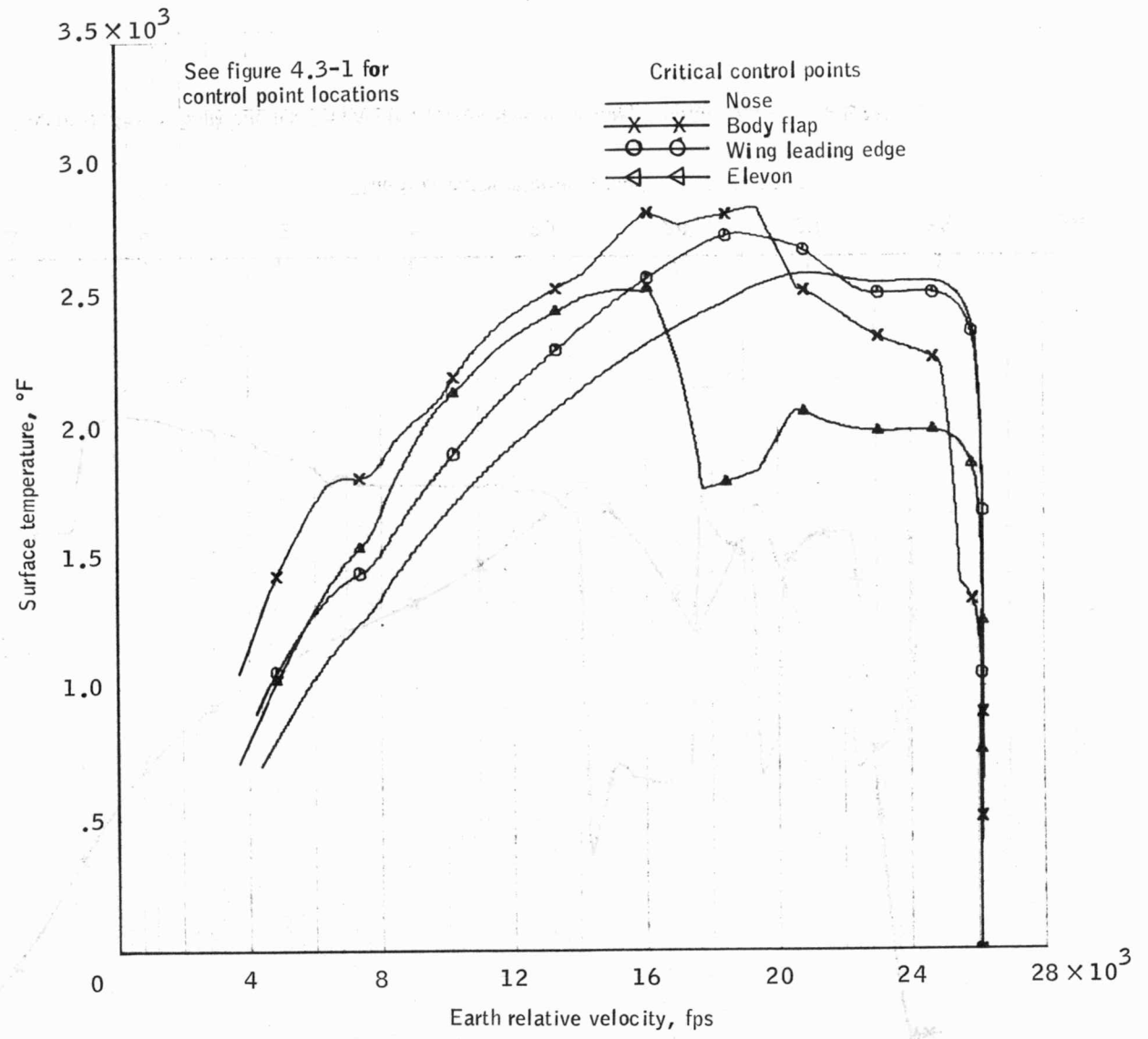

Figure 4.3-9.- Bank and heading angles versus time from entry interface for shuttle BRM 3B.



(a) Earth relative velocity.

Figure 4.3-10.- Control point surface temperatures for shuttle BRM 3B.



75

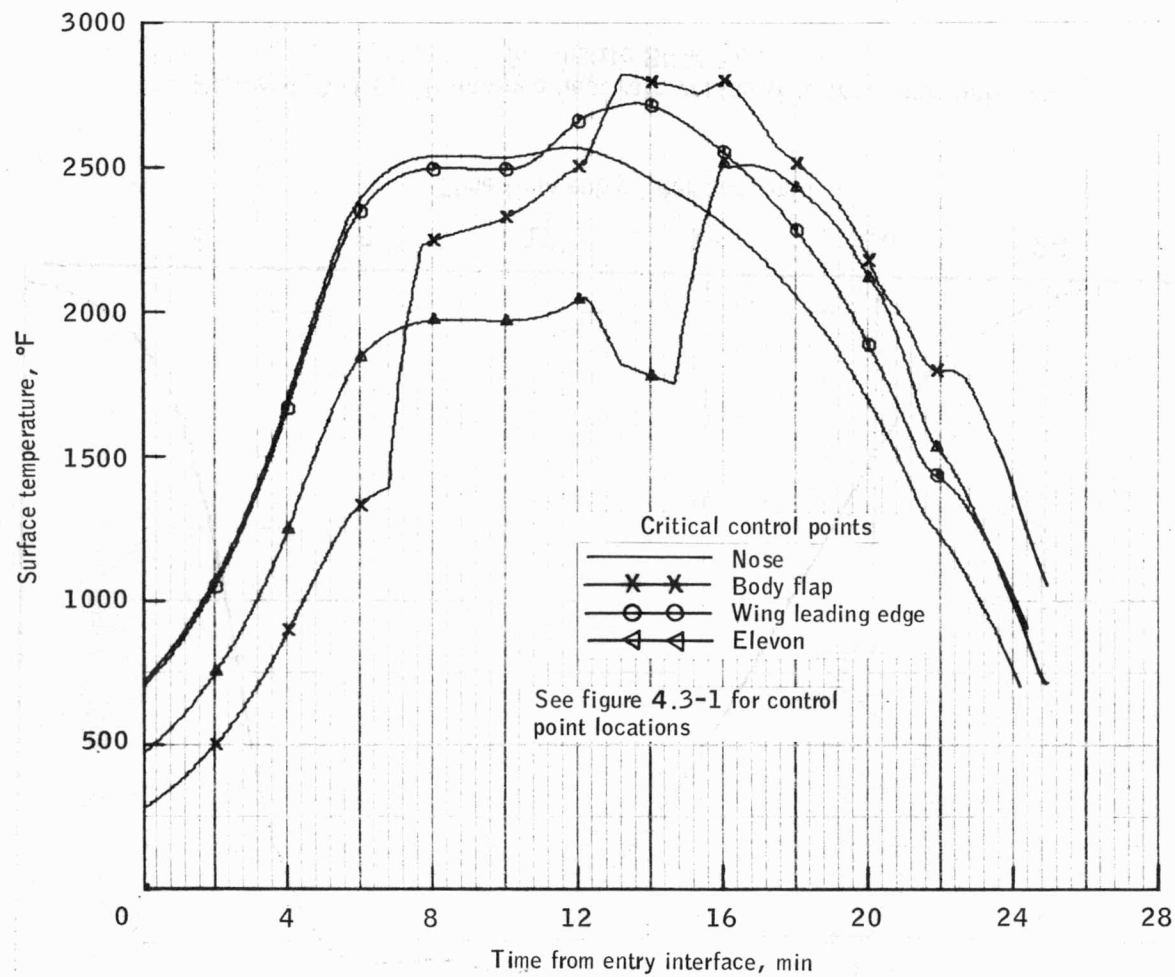

(b) Time from entry interface.

Figure 4.3-10.- Concluded.

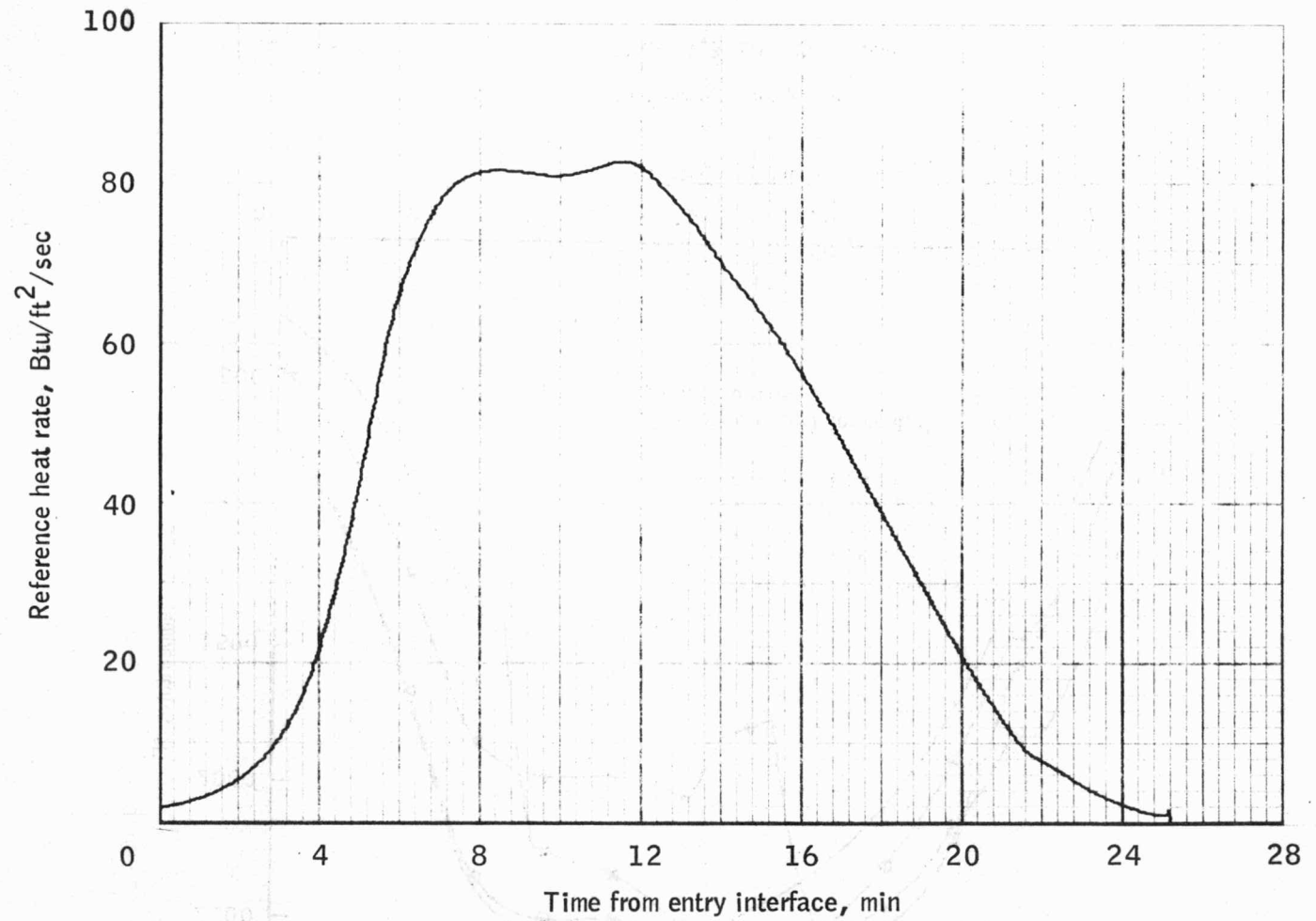

Figure 4.3-11.- Reference heat rate versus time from entry interface for shuttle BRM 3B.

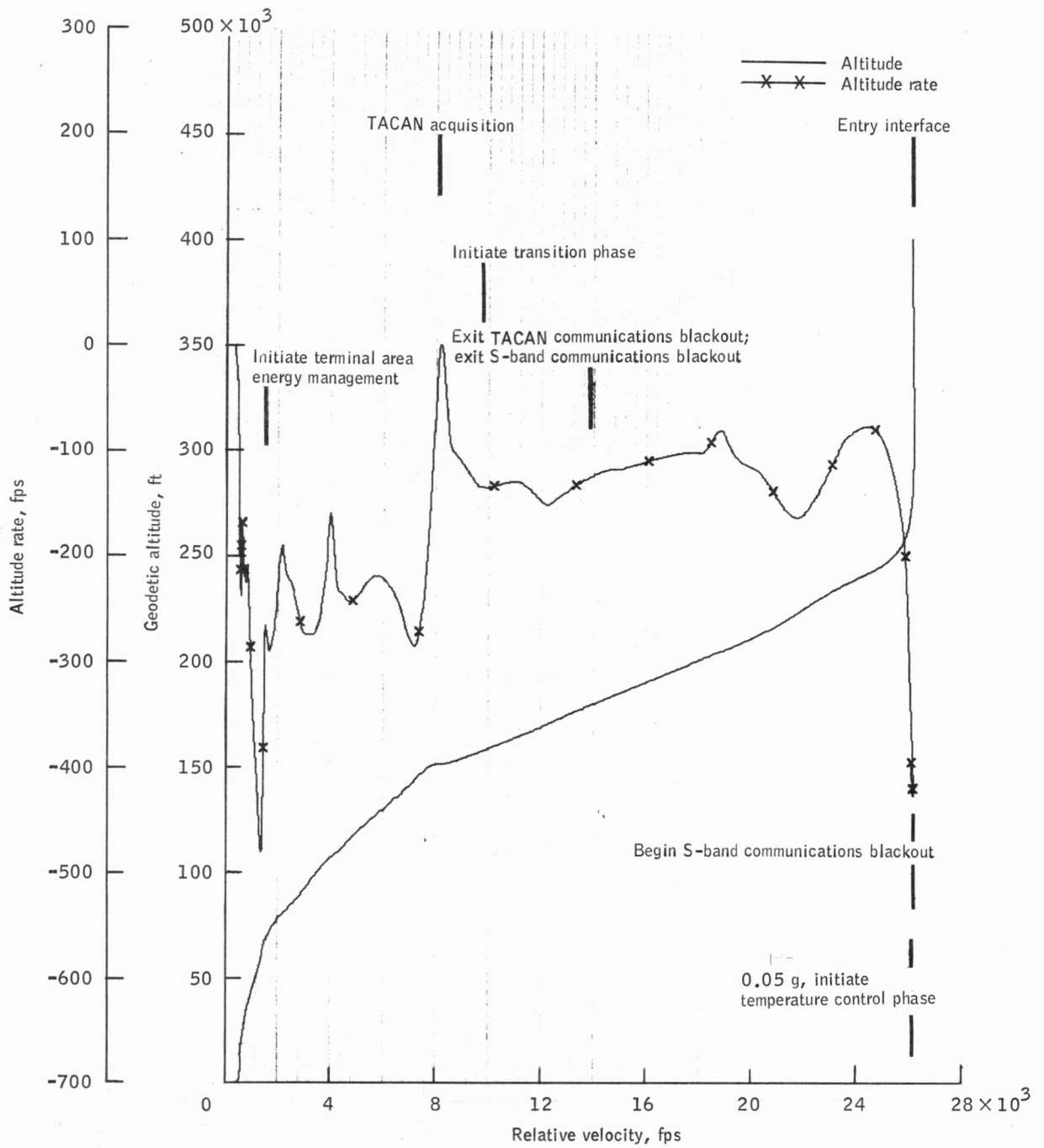

Figure 4.3-12.- Altitude and altitude rate versus relative velocity for shuttle BRM 3B.

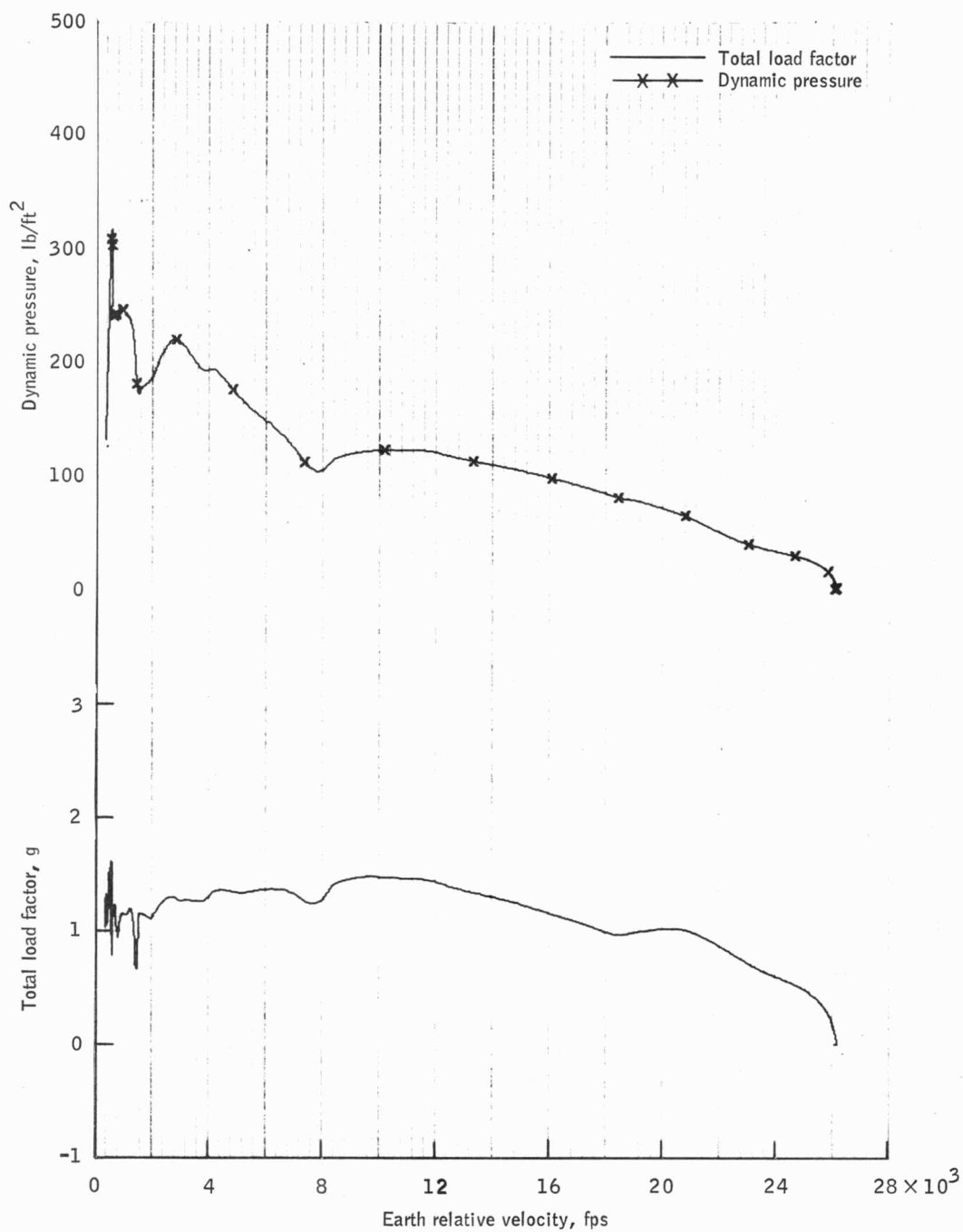

Figure 4.3-13.- Dynamic pressure and total load factor versus relative velocity for shuttle BRM 3B.

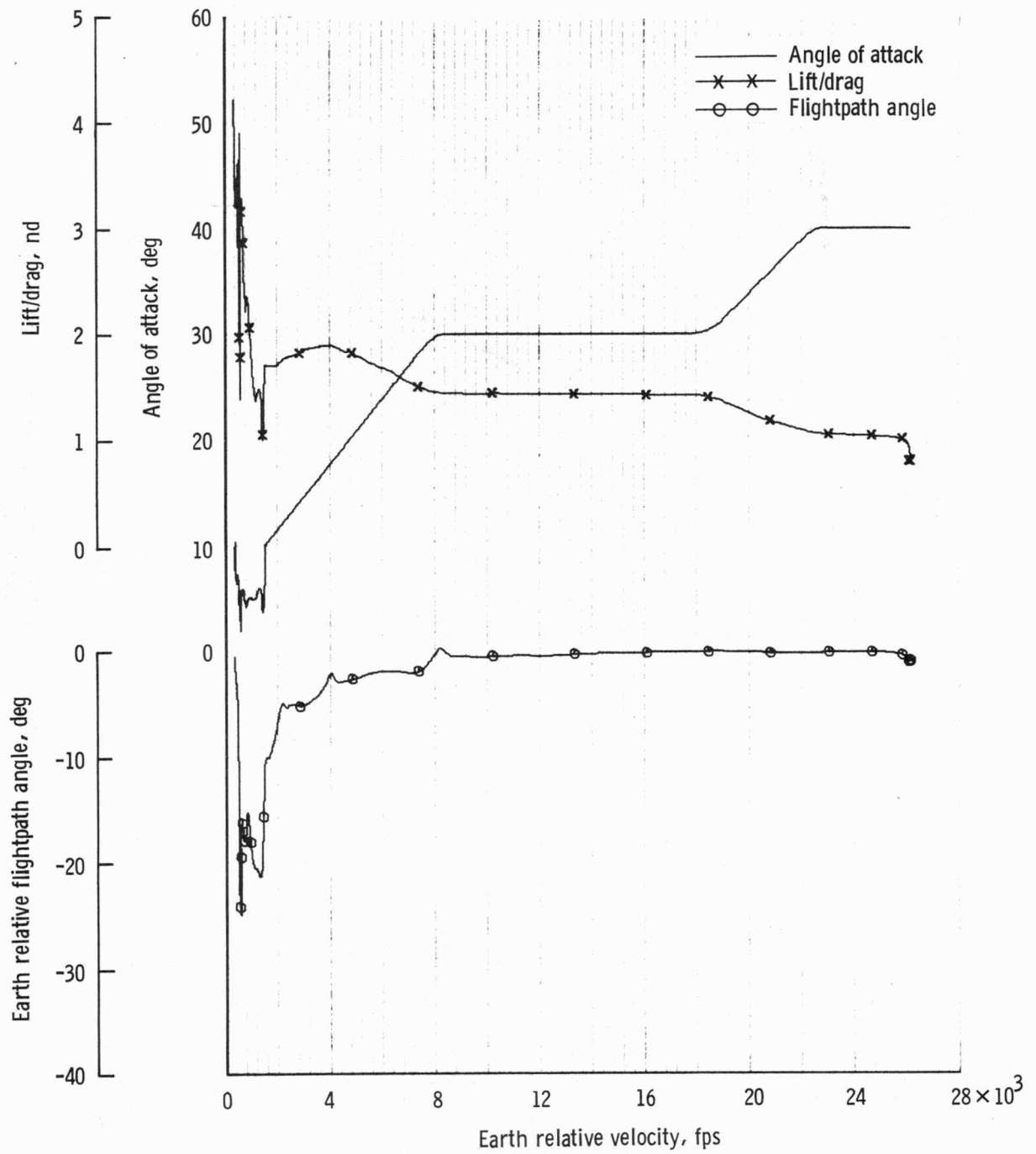

Figure 4.3-14. - Angle of attack, lift/drag, and Earth relative flightpath angle versus relative velocity for shuttle BRM 3B.

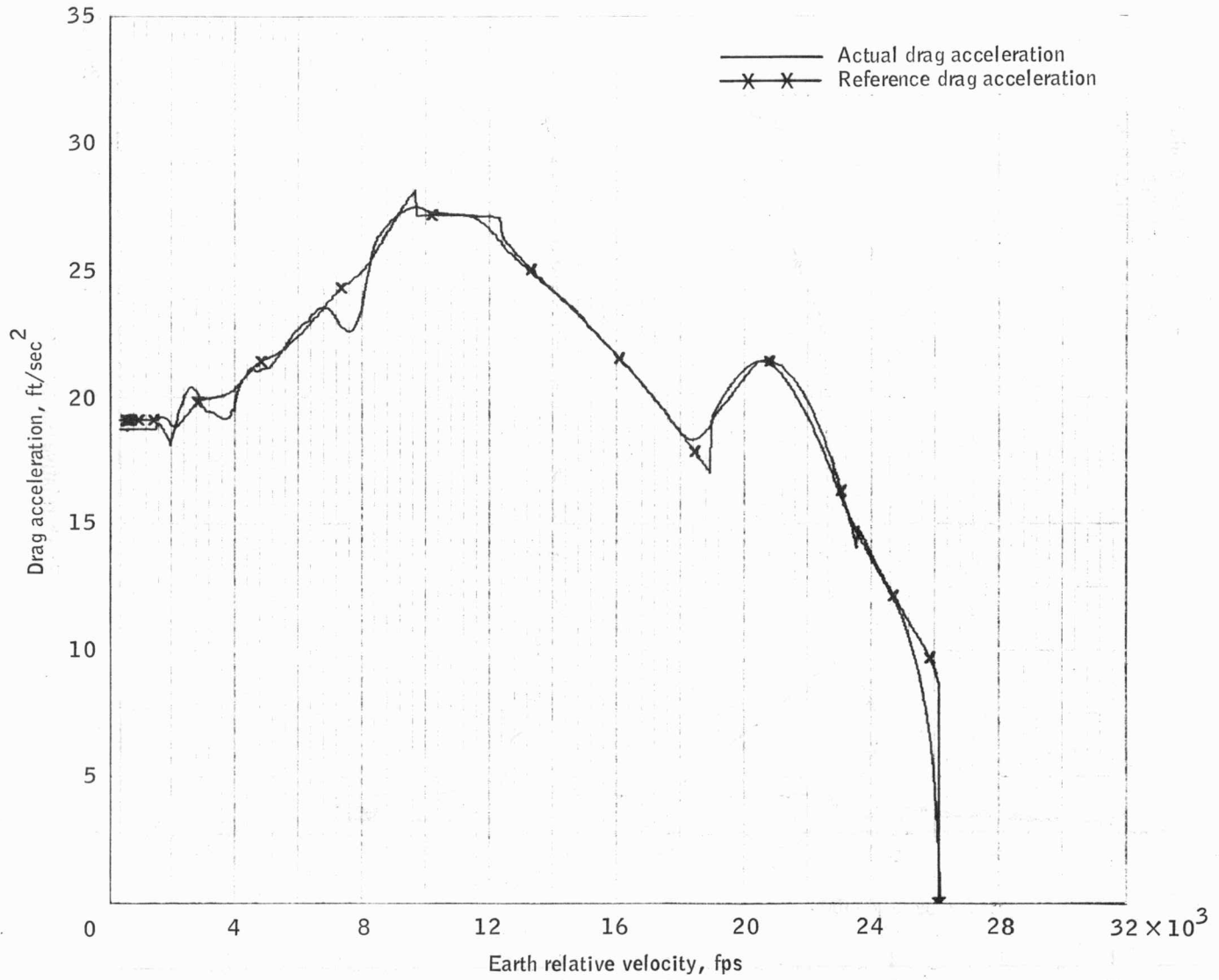

Figure 4.3-15.- Actual and reference drag acceleration versus relative velocity for shuttle BRM 3B.



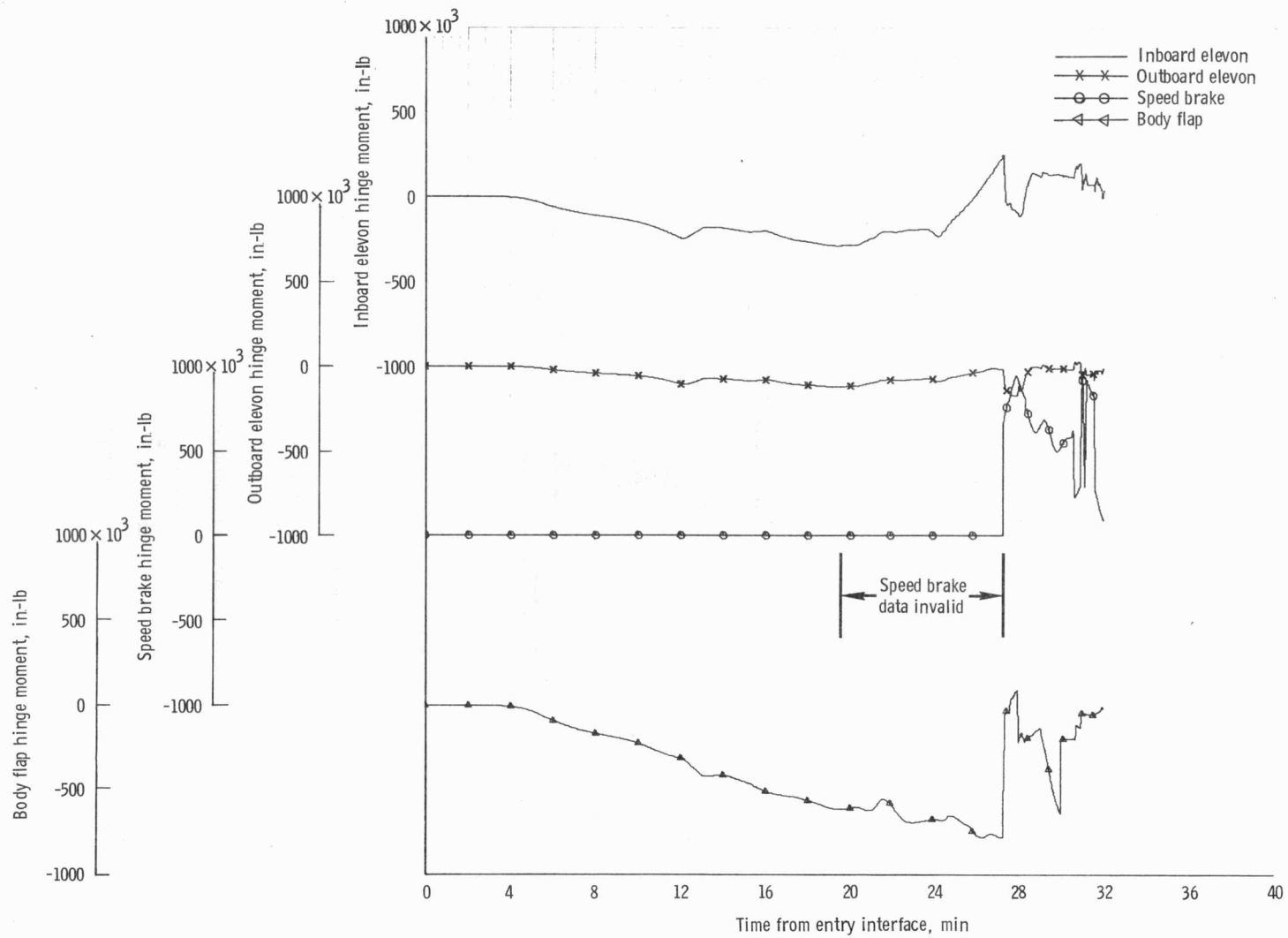

Figure 4.3-16. - Elevon, speed brake, and body flap hinge moments versus time from entry interface for shuttle BRM 3B.

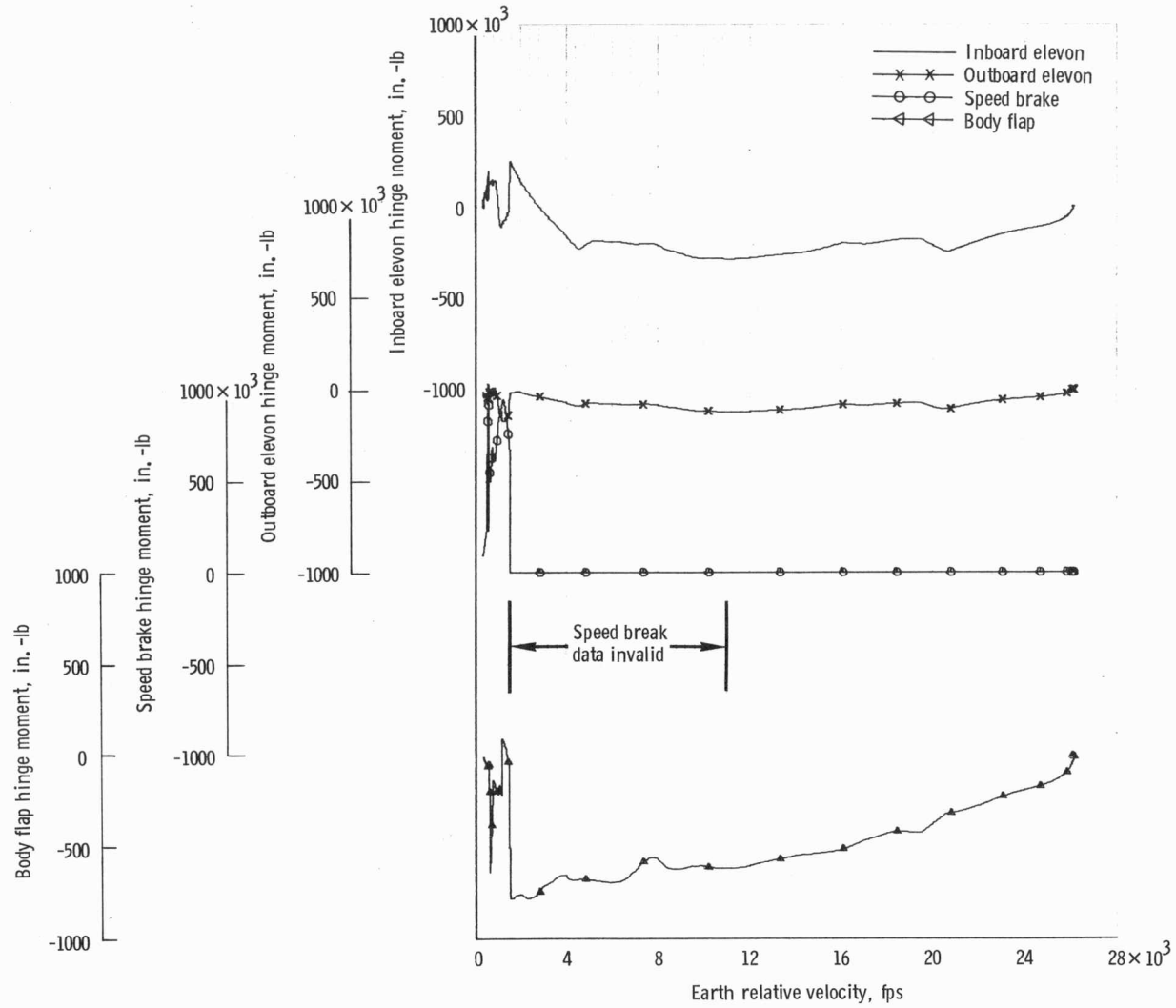

Figure 4.3-17. - Elevon, speed brake, and body flap hinge moments versus relative velocity for shuttle BRM 3B.

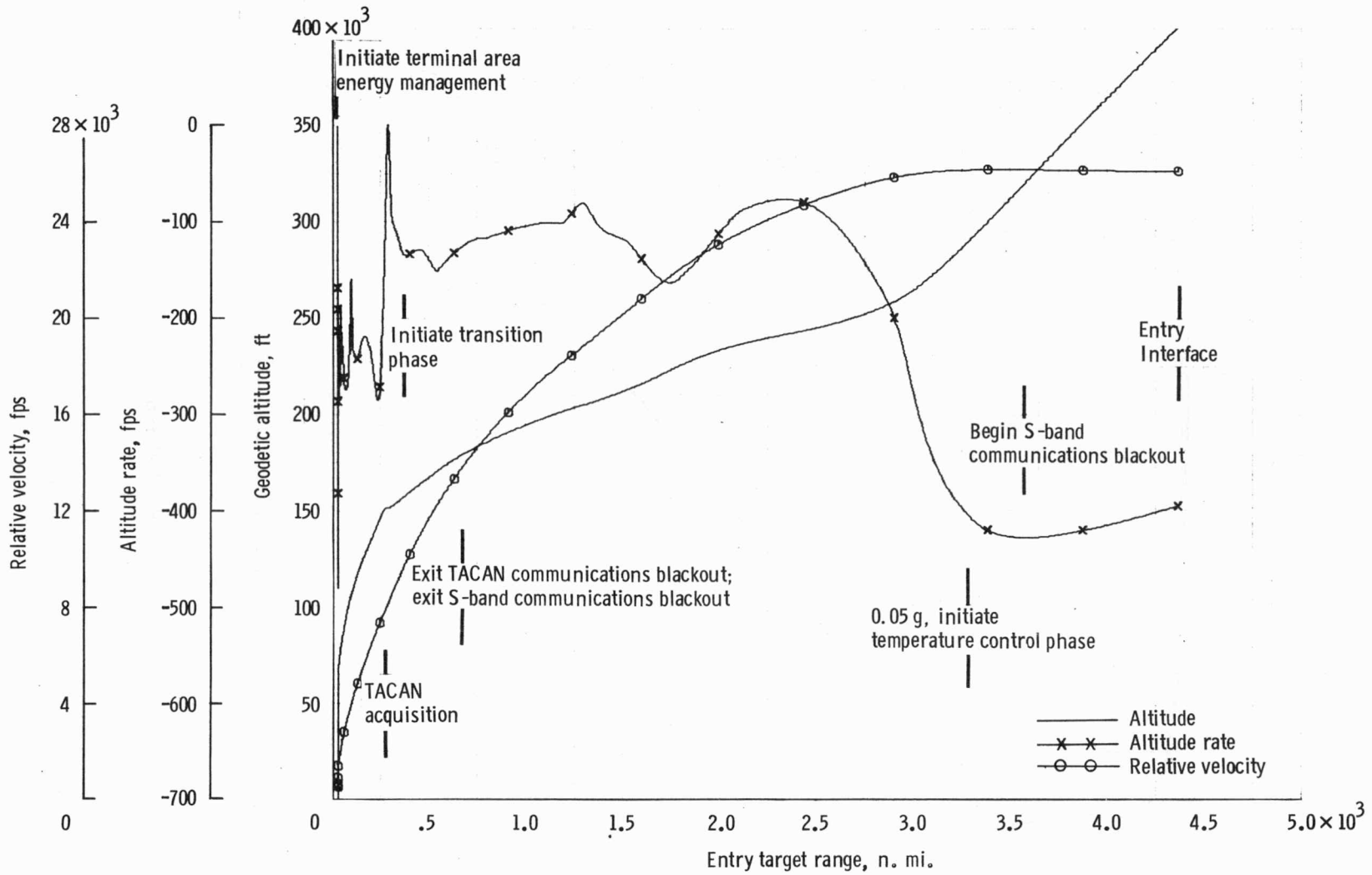

Figure 4.3-18. - Altitude, altitude rate and relative velocity versus entry target range for shuttle BRM 3B.

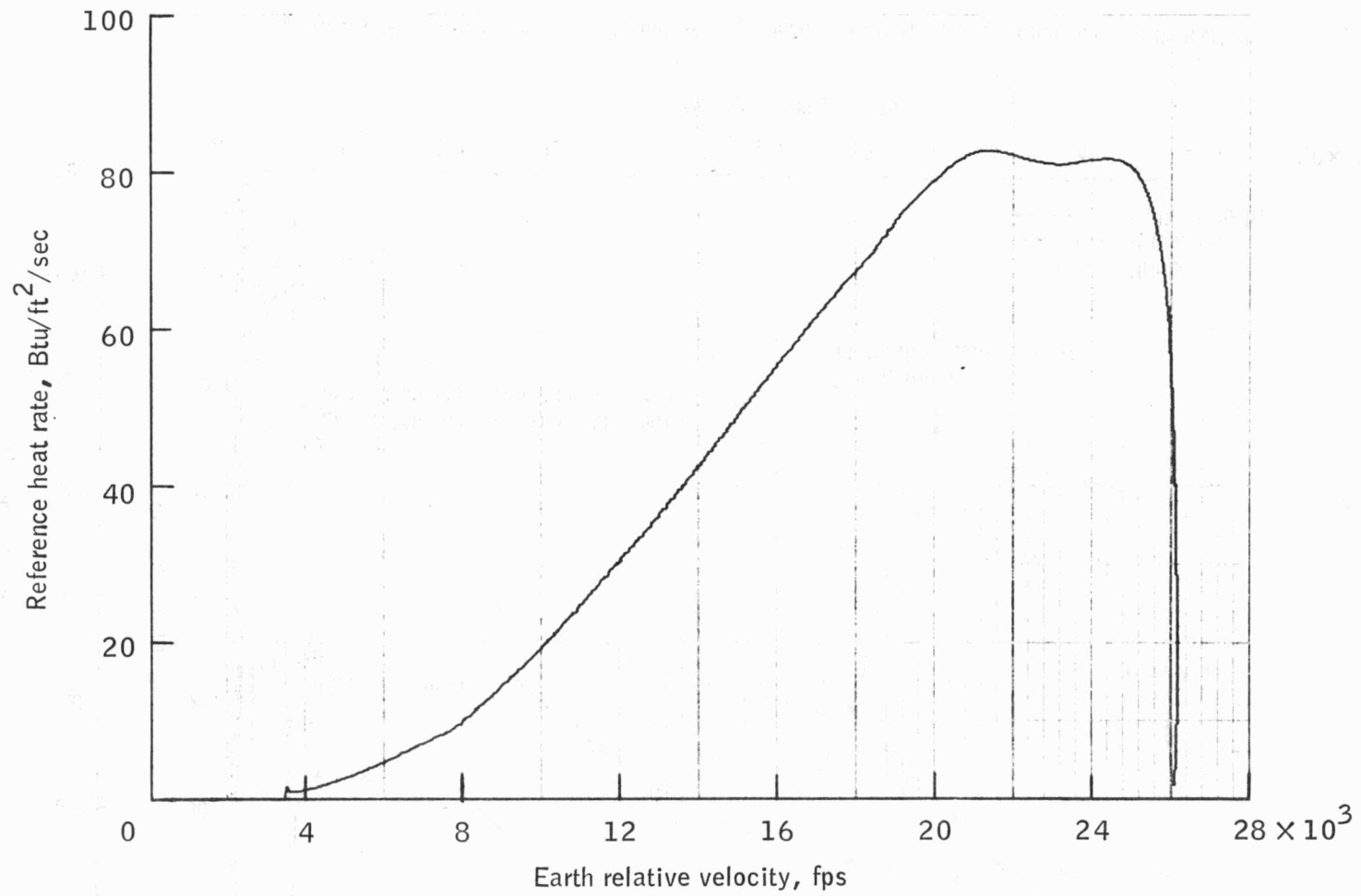

Figure 4.3-19.- Reference heat rate versus relative velocity for shuttle BRM 3B.

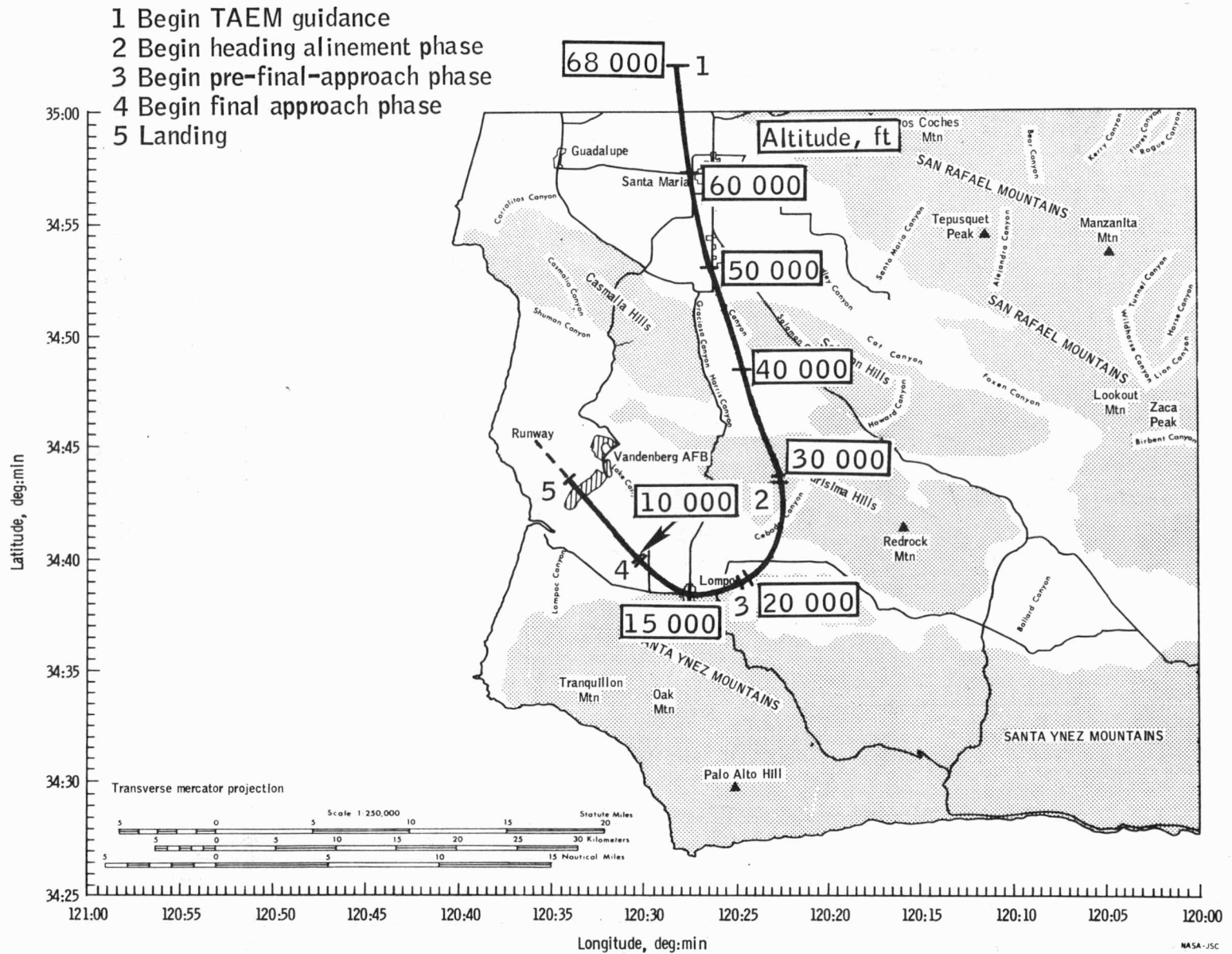

Figure 4.3-20.- Terminal area groundtrack for shuttle BRM 3B.

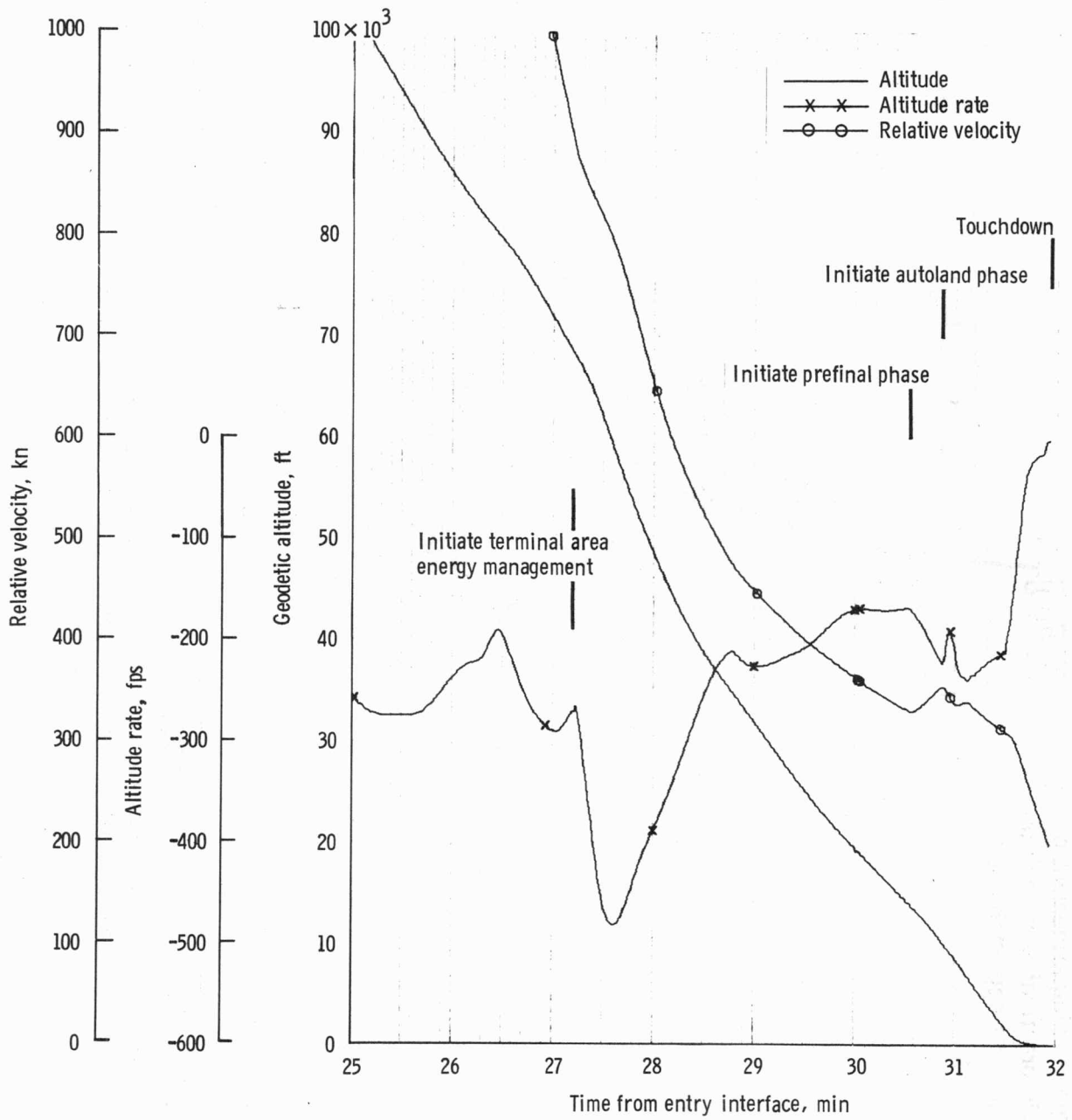

Figure 4.3-21. - Altitude, altitude rate, and relative velocity versus time from entry interface for shuttle BRM 3B.



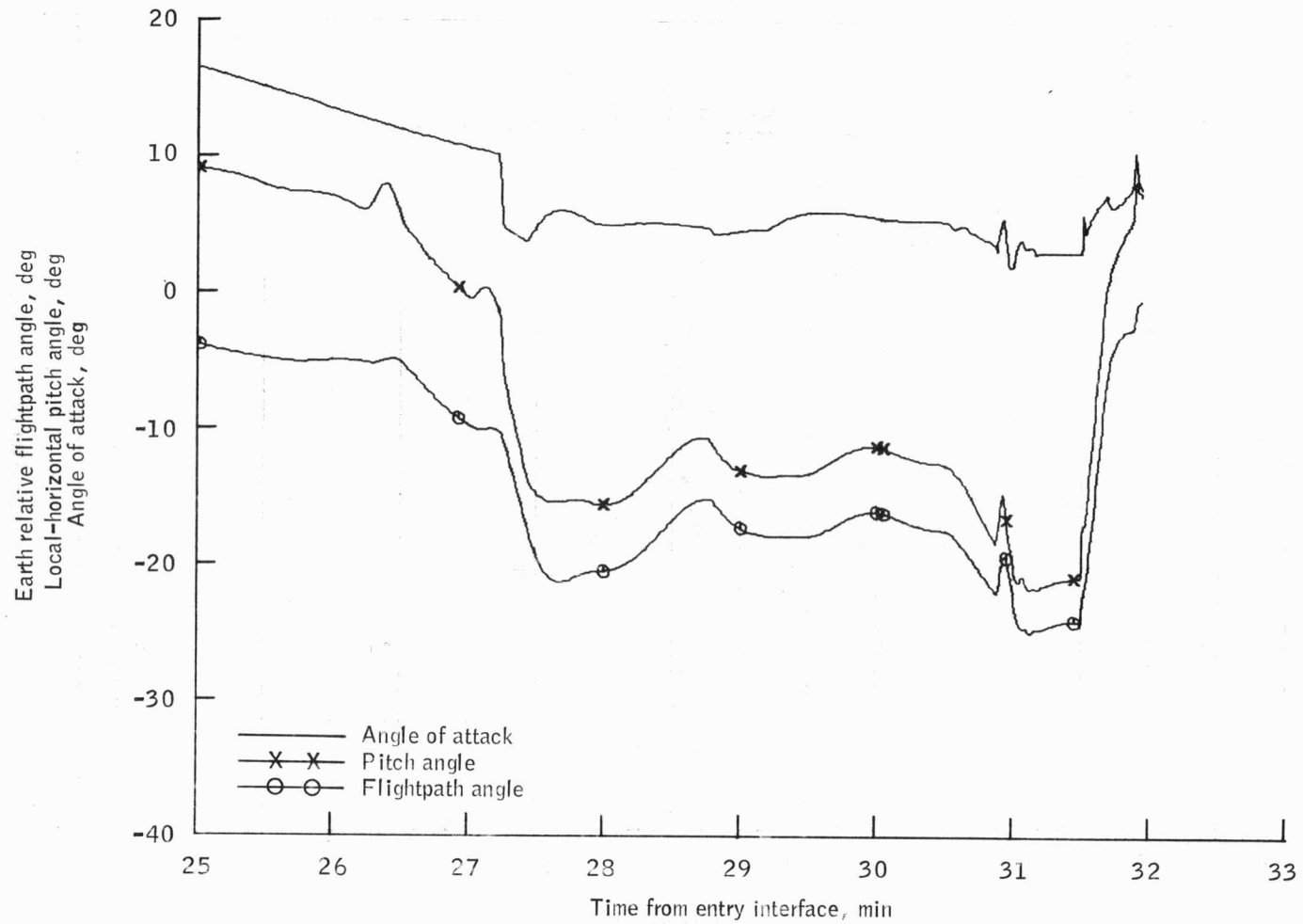

Figure 4.3-22.- Angle of attack, local-horizontal pitch angle and Earth relative flightpath angle versus time from entry interface for shuttle BRM 3B.

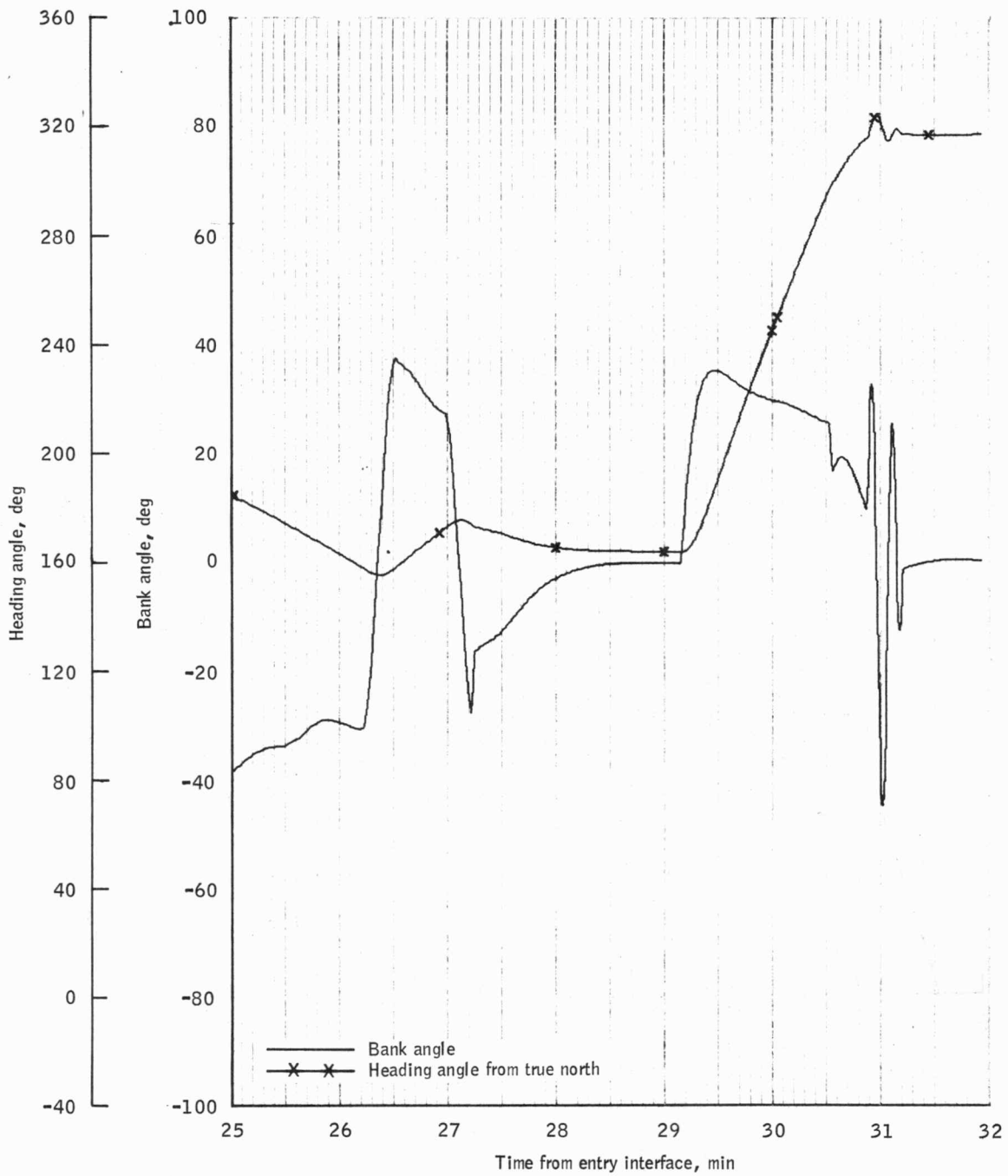

Figure 4.3-23.- Bank and heading angles versus time from entry interface for shuttle BRM 3B.

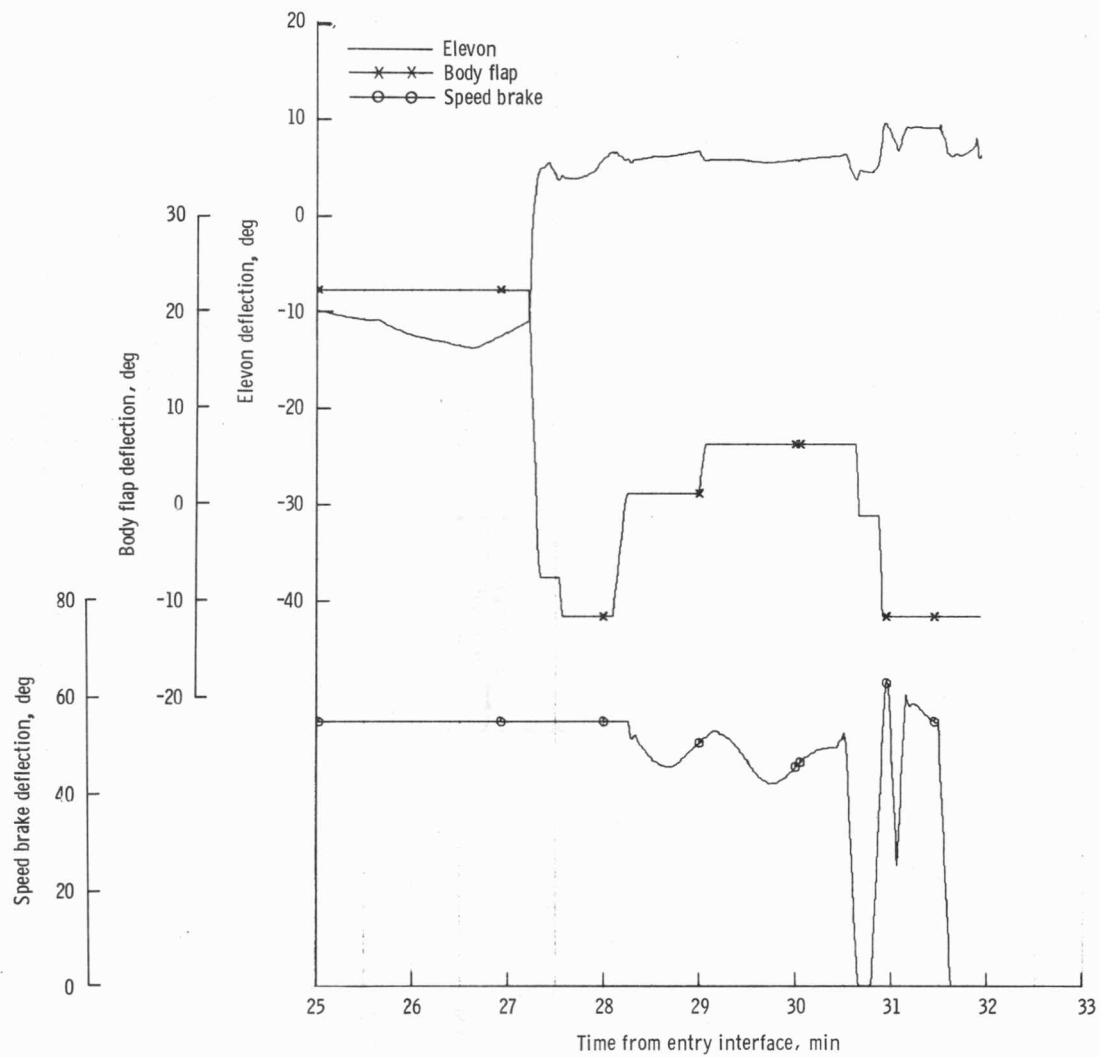

Figure 4.3-24. - Elevon, body flap, and speed brake deflection versus time from entry interface for shuttle BRM 3B.

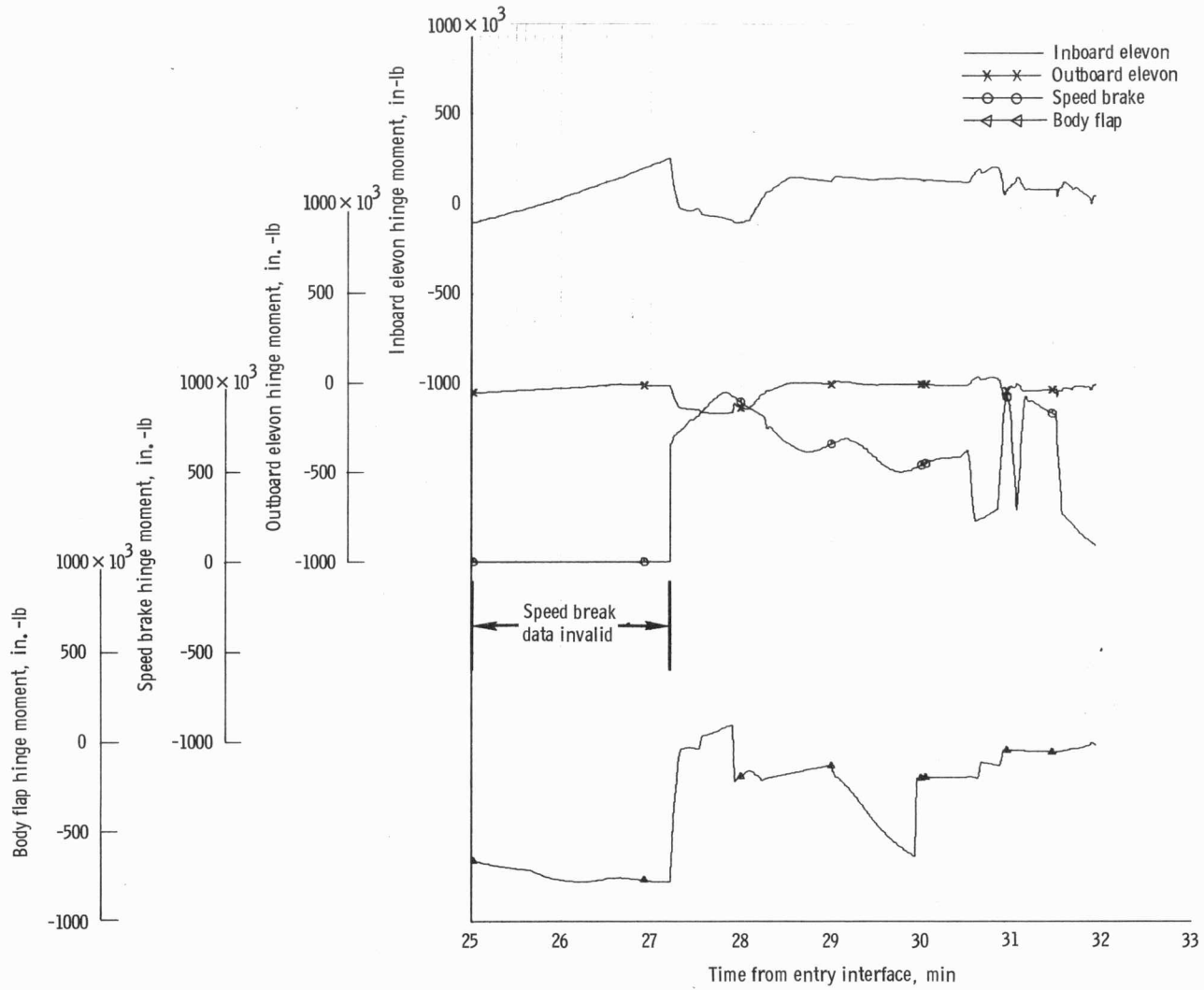

Figure 4.3-25. - Elevon, speed brake, and body flap hinge moments versus time from entry interface for shuttle BRM 3B.

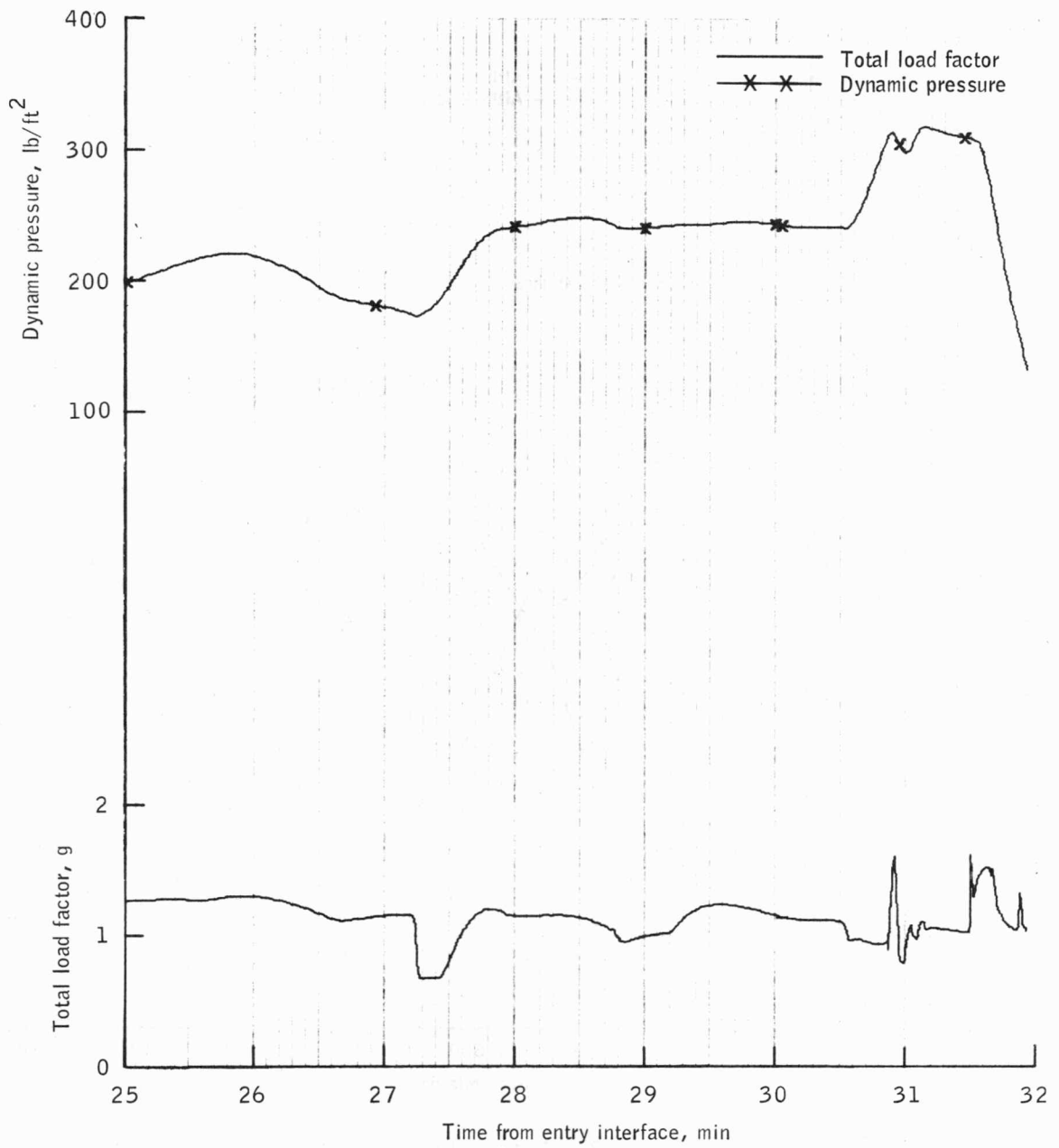

Figure 4.3-26.- Total load factor and dynamic pressure versus time from entry interface for shuttle BRM 3B.

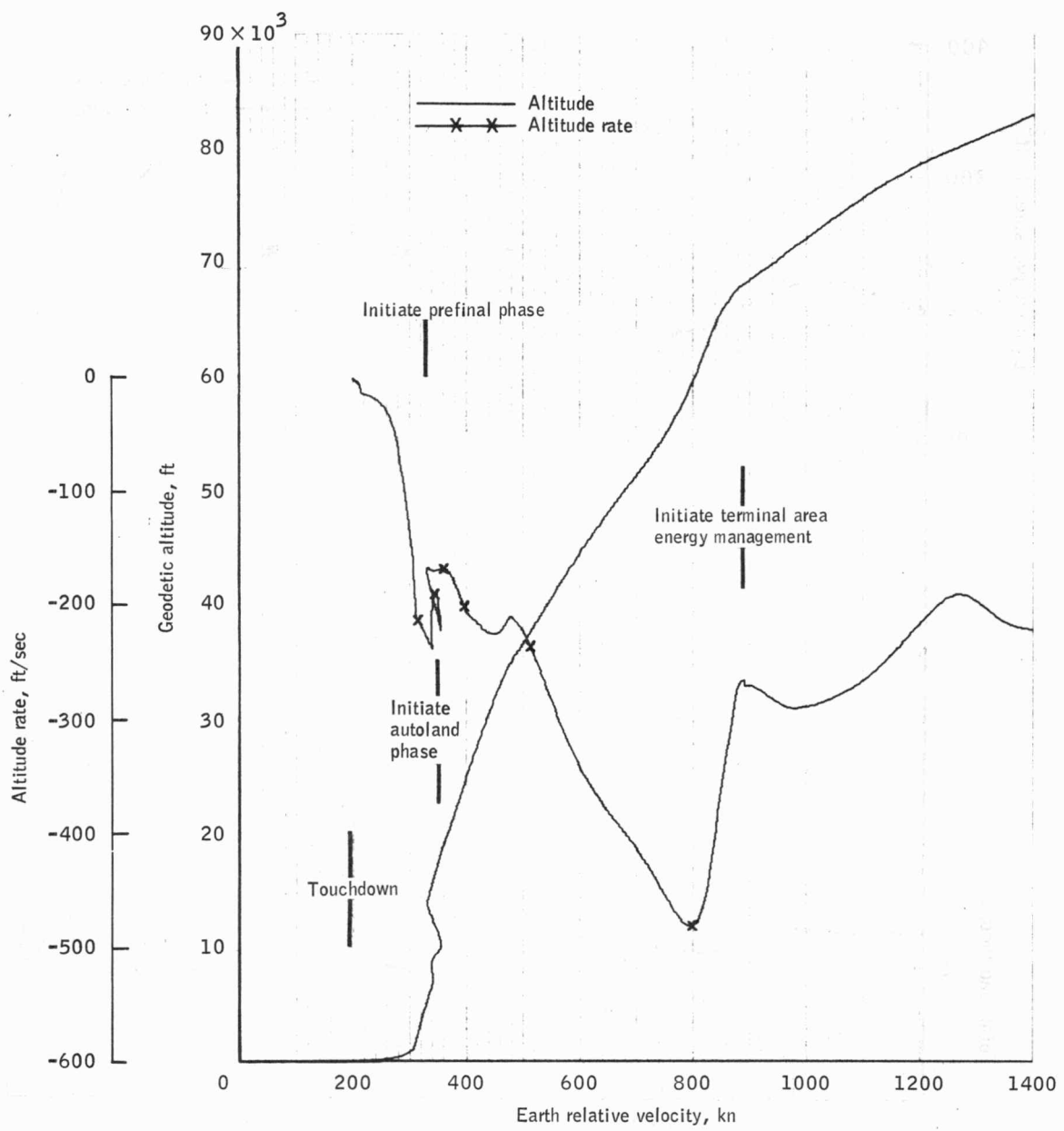

Figure 4.3-27.- Altitude and altitude rate versus relative velocity for shuttle BRM 3B.



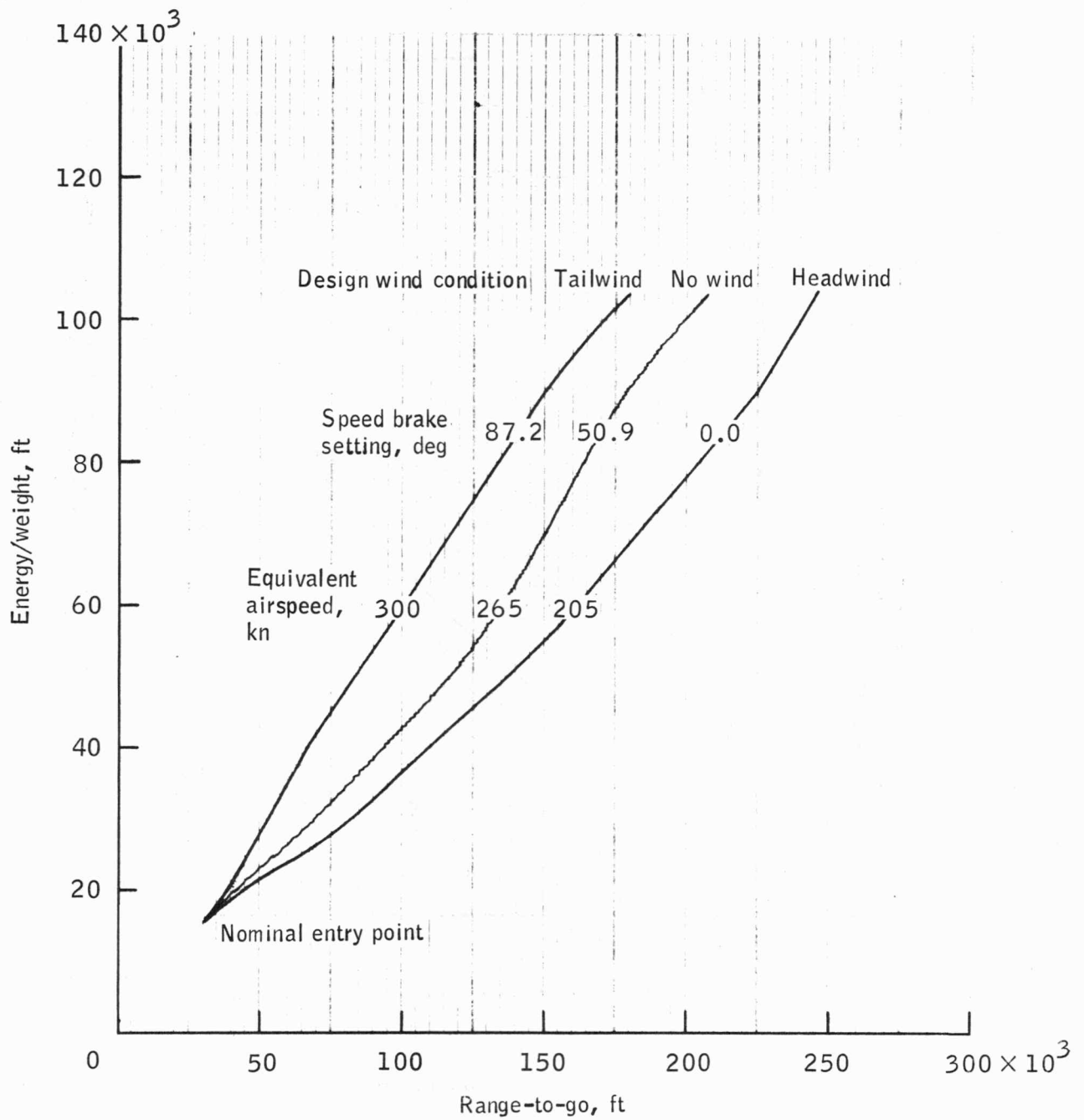

Figure 4.3-28.- Energy/weight versus range-to-go for shuttle BRM 3B.

16

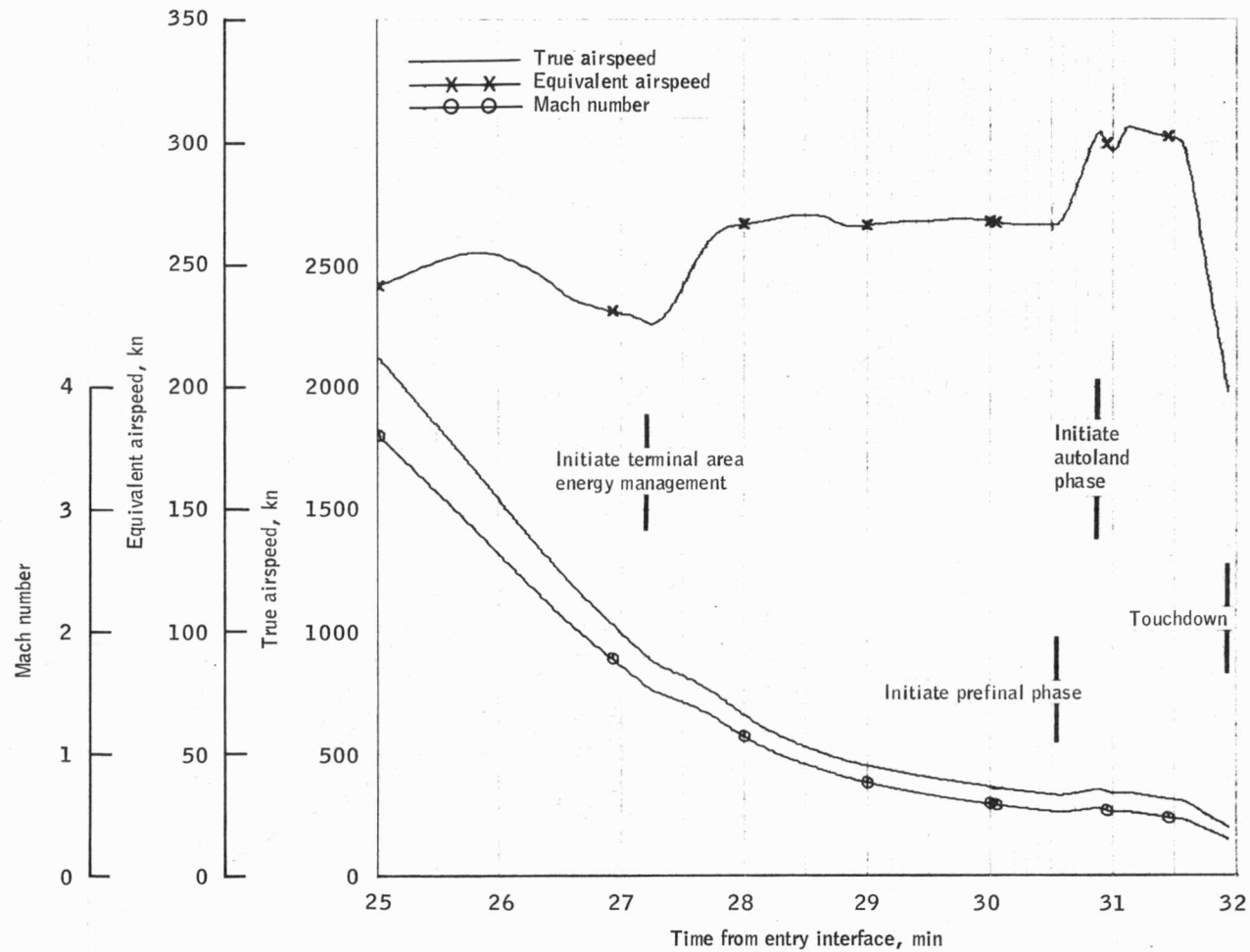

Figure 4.3-29.- True airspeed, equivalent airspeed, and mach number versus time from entry interface for shuttle BRM 3B.

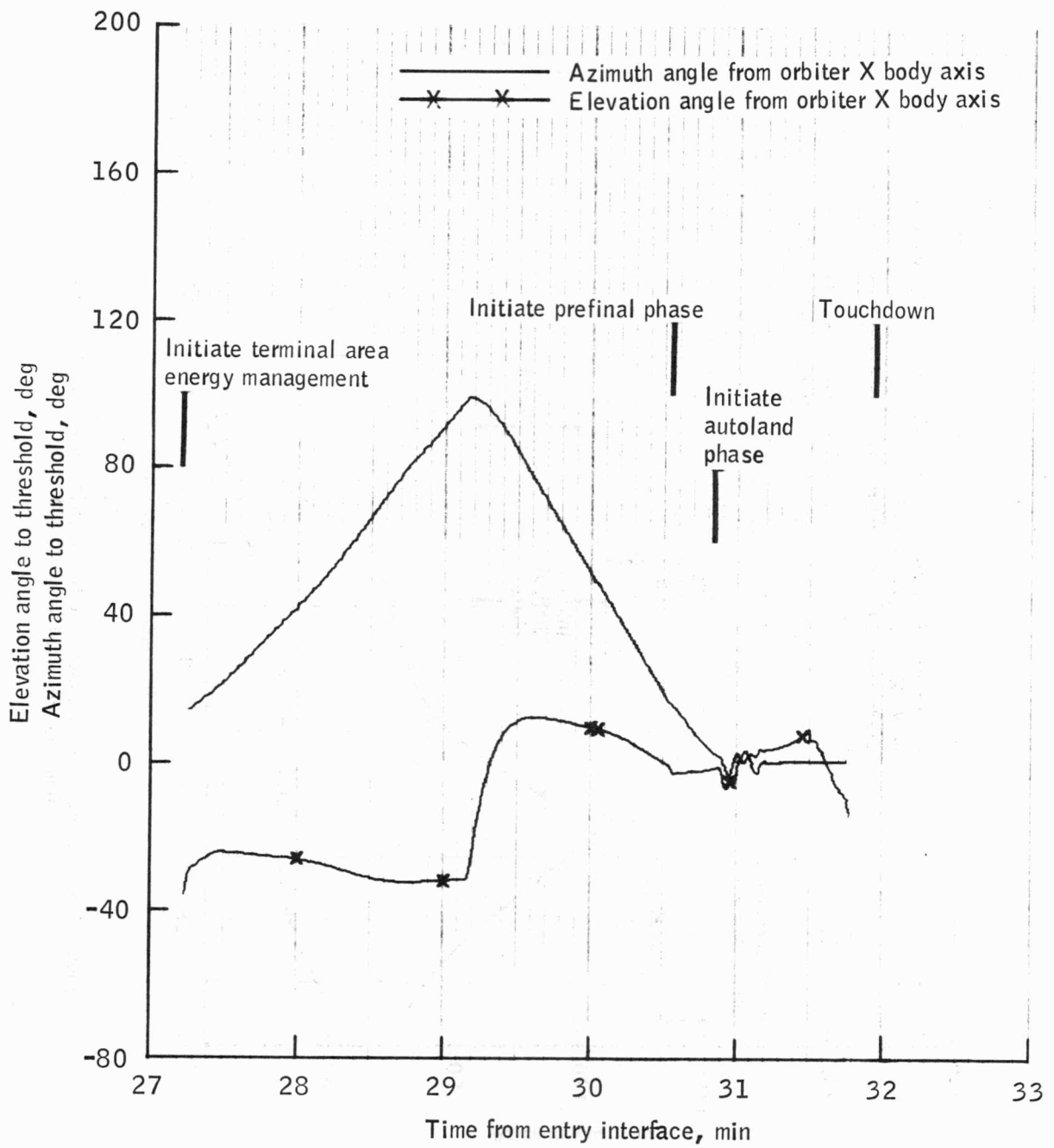

Figure 4.3-30.- Orbiter to threshold azimuth and elevation angles versus time from entry interface for shuttle BRM 3B.

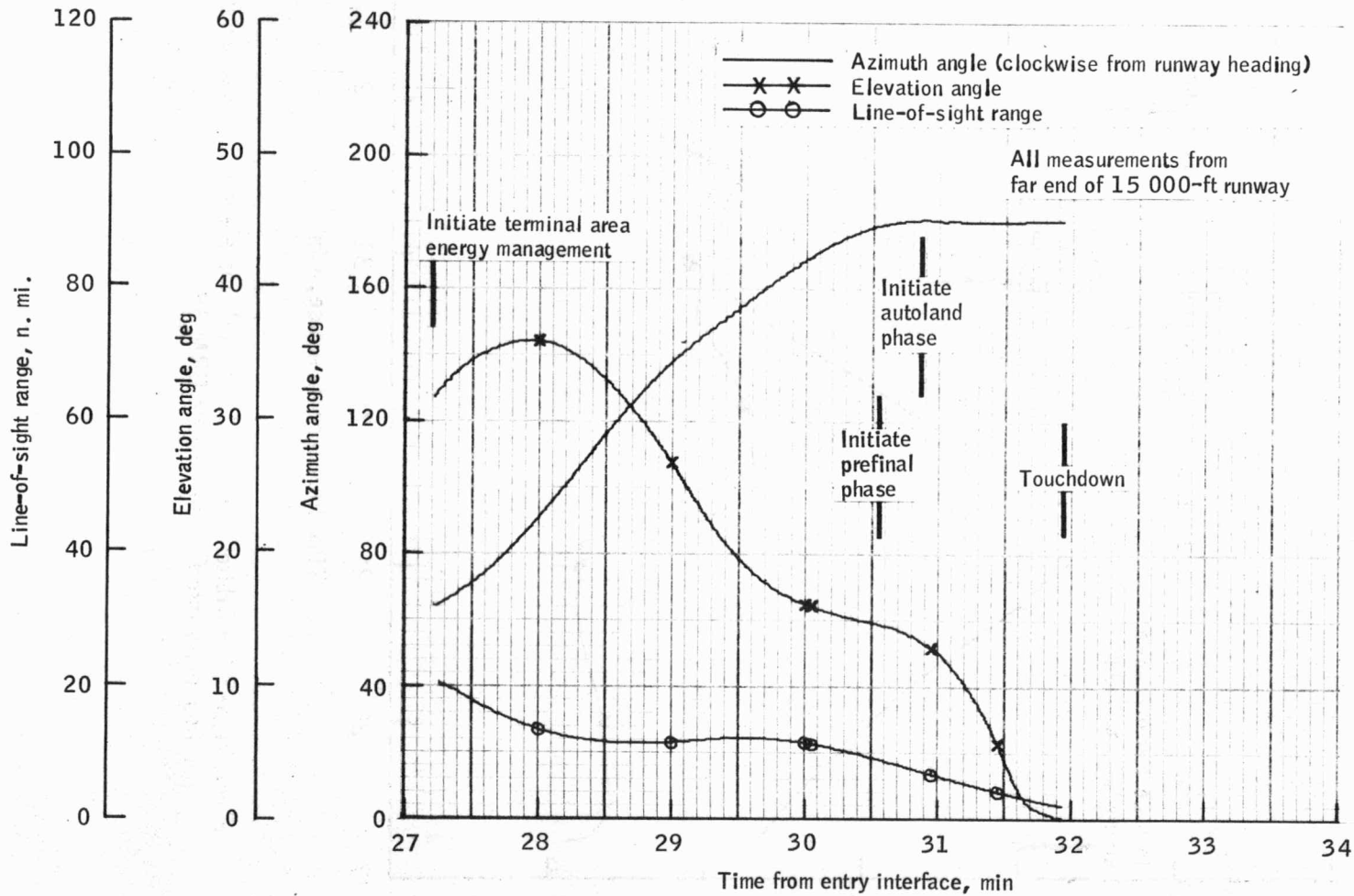

Figure 4.3-31.- Azimuth, elevation, and line-of-sight range to orbiter versus time from entry interface for shuttle BRM 3B.

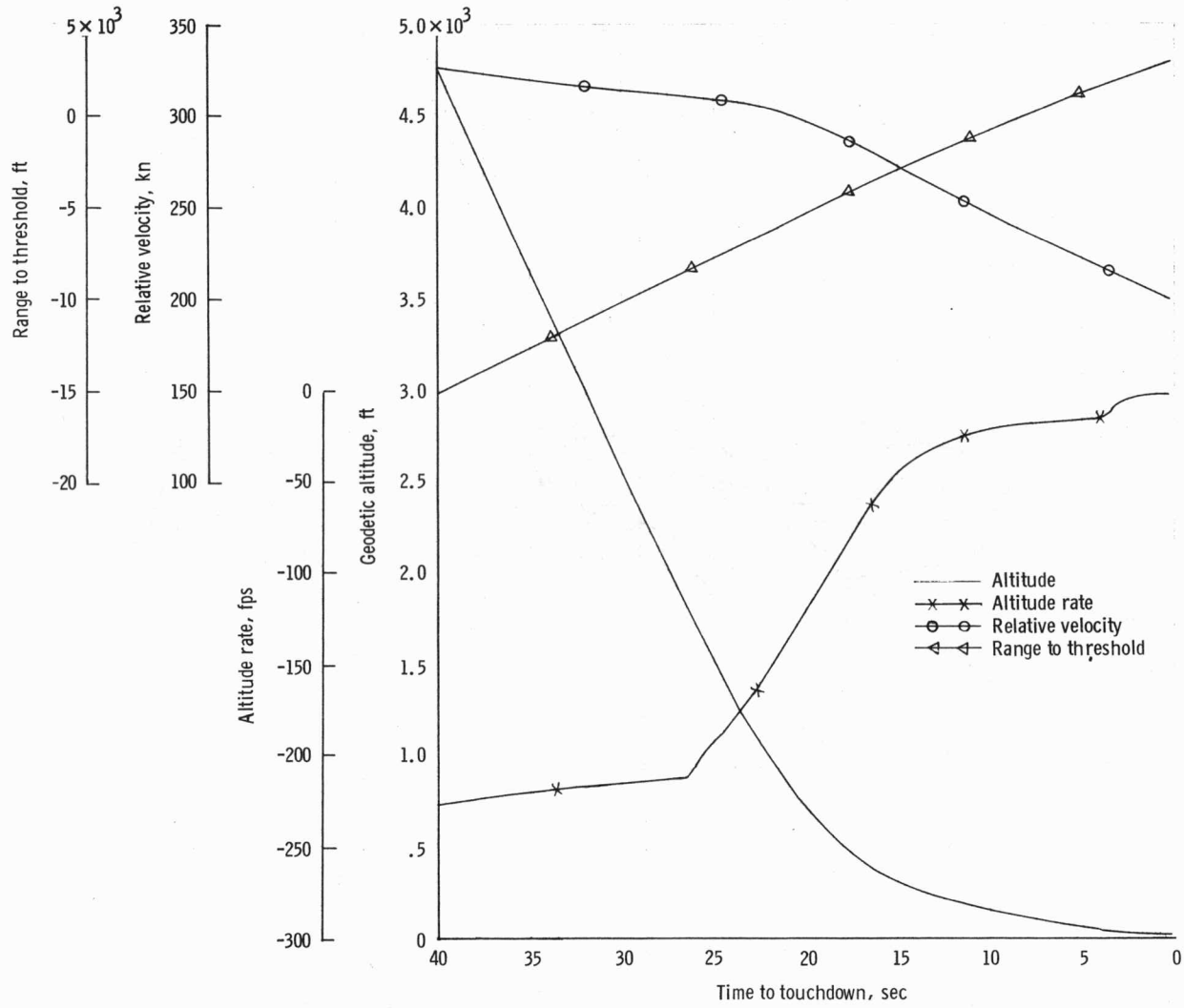

Figure 4.3-32. - Altitude, altitude rate, relative velocity, and range to threshold versus time to touchdown for shuttle BRM 3B.

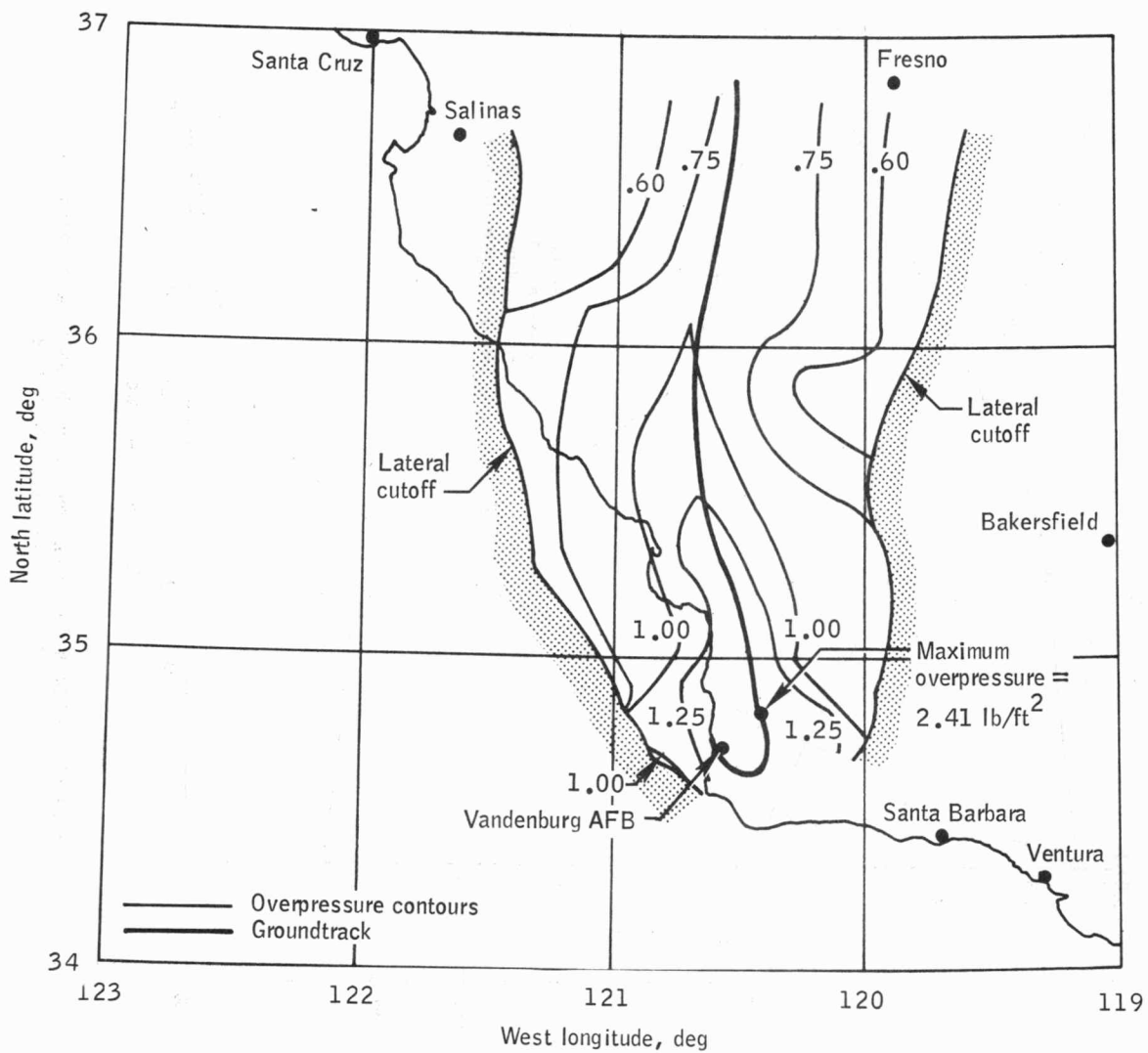

Figure 4.3-33.- Ground-level-sonic-boom-overpressure contours for shuttle BRM 3B (Vandenberg AFB landing site).

## 5.0 MISSION EVALUATION

### 5.1 ASCENT

The ascent trajectory described in this document is based on a nominal on-time lift-off and nominal systems performance. Additional yaw steering and/or SSME throttling will be required to maintain the direct ascent rendezvous targeting (i.e., range, velocity, altitude, flightpath angle) if other than nominal conditions occur.

### 5.2 ONORBIT

The onorbit time line for this mission is time critical. It may be desirable to increase the available time for onorbit operations by deploying the payload bay doors and the rendezvous radar manually instead of waiting to reconfigure the onboard computer. This could save approximately 1.5 to 2 minutes by performing these operations in parallel (i.e., reconfigure the onboard computer while opening the bay door and deploying the radar).

The 180-degree roll maneuver immediately following orbit insertion and reconfiguration of the orbiter for onorbit operations (i.e., g.e.t. = 00:14:00) is time critical, and it was necessary to perform this maneuver at 3 deg/sec (see sec. A7.0, item a). If it is not possible or if it is undesirable to roll the vehicle at 3 deg/sec, then consideration should be given to initiating this maneuver at insertion (g.e.t. = 00:12:00) at 1 deg/sec and to performing the maneuver manually while reconfiguring the orbiter for onorbit operations. Another option is to perform the maneuver during the insertion burn.

The rendezvous trajectory described in this document is based on all nominal conditions. A theoretically nominal braking delta-V of 48.8 fps is indicated, but this does not include dispersions or man-in-the-loop simulation results. The actual braking delta-V could be three to four times this theoretical nominal value. Therefore, the level I delta-V allowances should be used for propellant budgeting since they include some man-in-the-loop simulation results.

### 5.3 DEORBIT AND ENTRY

The deorbit targeting for mission 3B is such as to maximize the onorbit time available for other mission events. Therefore, the biasing for one-OMS deorbit was just sufficient to stay within the level I requirements (425 fps), and the nominal two-OMS deorbit was 328.2 fps.



Although the baseline guidance systems for the TAEM, prefinal, and autoland phases were used in the generation of the TAEM-through-touchdown data, the performance of the prefinal and autoland systems is considered unsatisfactory and gain changes and/or system redesign is required.

#### 5.4 COMPLIANCE WITH LEVEL I REQUIREMENTS

Mission 3B complies with level I requirements for onorbit delta-V (i.e., 425-fps onorbit OMS delta-V and 190-fps RCS translation delta-V). However, as explained in section 5.3, the level I margin was not maximized. Instead, the deorbit ignition time was delayed to maximize the onorbit time. The deorbit ignition will occur approximately 3 to 4 minutes earlier if the targeting is biased for equal primary and backup propellant usage (i.e., max. level I margins). This reduced onorbit time would have to be subtracted from the stationkeeping time (1 minute 23 seconds) and/or from the deorbit preparation time (8 minutes, with a minimum of 5 minutes required). Detailed man-in-the-loop simulations are required to more accurately determine the onorbit time lines.

APPENDIX A - SHUTTLE BRM 3B GROUND RULES AND CONSTRAINTS

## APPENDIX A

### SHUTTLE BRM 3B GROUND RULES AND CONSTRAINTS

#### A1.0 ASCENT

a. The nominal ascent trajectory for mission 3B is designed to achieve insertion conditions satisfactory for direct rendezvous with a satellite, retrieval of the satellite, and return to the WTR one revolution after lift-off. The target satellite is in an orbit inclined at 104 degrees, at an altitude of 100 nautical miles.

b. Mission 3B does not deliver a payload to orbit. The lift-off weight includes an assumed 2500-pound adapter weight, which is charged to payload.

c. The nominal ascent will be designed for an on-time lift-off.

d. The maximum nominal allowable dynamic pressure (max q) is 650 lb/ft<sup>2</sup>.

e. Aerodynamic lift forces are not considered.

f. The SRB cant angles are assumed to be zero.

g. The space shuttle main engines (SSME's) are gimballed so that the resultant total thrust is directed 12 degrees from the orbiter centerline in the pitch plane.

h. The SRB separation is assumed to be instantaneous and non-propulsive.

i. The 1971 Vandenberg reference atmosphere is used for ascent analysis. No winds are assumed.

j. The vehicle is oriented on the pad with the -Z body axis (tail) pointed south.

k. The vehicle pitch turning rate is limited to 1 deg/sec from lift-off to MECO.

l. The maximum acceleration limit is 96.52 ft/sec<sup>2</sup> (3 g's).

m. If an orbiter main engine fails after the time when a return to the launch site (RTL) is no longer possible, the orbiter will abort to the nominal MECO targets (alt., V, gamma).

n. The sequence of events required for orbiter/ET separation is defined in table 4.3-I.

o. The venting of the SSME propellant residuals in the orbiter during the orbital insertion maneuver is assumed to be instantaneous and nonpropulsive.

p. The yaw cant angle for the OMS engines is zero during the orbital insertion maneuver.

q. The flight performance reserve (FPR) and fuel bias are as defined by mission 3A AOA or nominal insertion despite 3-sigma inaccuracies that cause larger than expected main engine propellant requirements during ascent.

r. A 100-percent power level (NPL) will be used at lift-off.

## A2.0 EXTERNAL TANK DISPOSAL

The following ground rules and constraints apply to all missions for external tank disposal.

a. External tank impact locations, including dispersions, shall be no closer than 200 nautical miles to land masses.

b. There shall be no external tank impact below the 60-degree south parallel, as per international scientific agreement.

c. External tank impact locations shall be in ocean areas with minimum ship traffic densities.

d. Constraints.

(1) No external tank impact locations will be on or near land masses.

(2) There will be no external tank impact below the 60-degree south parallel.

(3) External tank impact locations, including dispersions, shall be no closer than 200 nautical miles.

e. Assumptions and ground rules.

(1) There will be no external tank venting until 60 seconds after SSME cutoff.

(2) Estimated debris breakup will be simulated by use of ballistic numbers of 5.0 and 51.2 and an L/D of  $\pm 0.2$ .

(3) Primary ET breakup occurs at a 240 000-foot altitude for tumbling drag.

### A3.0 ORBITER/ET NOMINAL AND AOA SEPARATION

The following ground rules and constraints apply to the orbiter separation from the external tank for all nominal and AOA missions.

- a. Orbiter/ET mated attitude rates shall be damped to 0.1 deg/sec or less prior to physical separation.
- b. The orbiter shall perform a Z-axis translational maneuver from the ET, and minimum RCS translational delta velocity shall be 4 fps.
- c. The RCS -Z nominal separation acceleration shall be  $\geq 0.5$  ft/sec<sup>2</sup>, but safe separation shall allow for a minimum acceleration  $\geq 0.3$  ft/sec<sup>2</sup>.
- d. The orbiter shall not pass through the arc swept out by rotation of the ET once separation to a distance beyond the arc has occurred.
- e. The failure of one OMS engine shall not prevent safe separation from the external tank.
- f. Orbiter/ET nominal and AOA separation maneuver time line is shown in table A-1.

TABLE A-I.- ORBITER/ET NOMINAL AND AOA  
SEPARATION MANEUVER TIME LINE

Time		Event
<u>sec</u>	<u>min:sec</u>	
t+0	t+0:00	MECO; prepare for ET release; orbiter attitude hold
t+5	t+0:05	Orbiter/ET separation; begin 8-sec RCS -Z burn; -Z trans- lation; maintain attitude hold
t+13	t+0:13	End RCS -Z burn; begin 30-sec coast; delta velocity = 4 fps; maintain attitude hold
t+43	t+0:43	Begin two-engine OMS burn; +X translation for ET clearance; maintain attitude hold
t+65	t+1:05	Release attitude hold and begin orbiter orientation to OMS thrust vector



#### A4.0 ORBITAL OPERATIONS

a. The payload doors cannot be opened until 2 minutes after OMS thrusting is terminated. This time is required to reconfigure the onboard computer for orbital operation and also to reconfigure for deorbit and entry.

b. The payload bay doors will require 4 minutes to open and 3.5 minutes to close. Rendezvous sensor deployment will be completed 2 minutes after initiation of payload bay door opening.

c. For purposes of determining manipulator time lines, the retrieval payload is assumed to weigh 25 000 pounds and to be 10 feet in diameter and 60 feet long.

d. Time available for payload retrieval operations will be maximized.

e. The payload attitude will be stabilized for retrieval.

## A5.0 DEORBIT AND ENTRY

### A5.1 DEORBIT

a. A minimum of 5 minutes (dedicated) immediately prior to the deorbit is assumed for preparation for the maneuver.

b. The thrust is at an essentially constant pitch attitude with respect to the local horizon and obeys the linear tangent steering law.

c. A minimum free-fall time of 5 minutes between the termination of the deorbit maneuver and entry interface is assumed for entry preparation.

d. The deorbit maneuver is performed with both OMS engines, but an acceptable deorbit must be achieved even if one of these engines does not operate successfully. To accomplish this, the deorbit ignition (TIG) and delta velocity are biased.

e. The deorbit maneuver must satisfy the inertial velocity, inertial flightpath angle, and relative range requirements at entry interface and will reduce OMS propellant remaining for acceptable orbiter c.g. location for entry.

## A5.2 ENTRY THROUGH TOUCHDOWN

a. The radiation equilibrium temperature constraint on the orbiter RCC is 2950° F, and the HRSI is 2500° F.

b. The terminal area profile will be compatible with either a piloted or an automatic mode of operation.

c. Structural requirements are that the orbiter capability include typical unpowered terminal flight maneuvers with a design payload of 32 000 pounds and within a normal g load (Z body) of -1 g to 2.5 g's and/or include conformity to the effector hinge moment, control surface loads, and rates of the actuators.

d. The terminal area energy management (TAEM) guidance target q (240 lb/ft<sup>2</sup>) selection should be based on the concept of flying directly to the heading alignment circle without employing a procedural turn in tailwind conditions. Additionally, it should avoid undershoot conditions in the presence of severe headwinds. The energy control should be such that conditions suitable for the initiation of autoland on the final approach are achieved.

e. The baseline TAEM and autoland guidance were used in the generation of these trajectories.

f. Nominal touchdown speed and altitude rate have been selected that provide acceptable pitch margins and structural clearance, tire speeds, and landing gear structural loads.

g. Dynamic pressure is to remain between 130 lb/ft<sup>2</sup> and 300 lb/ft<sup>2</sup>.

h. Terminal area maneuvers shall not nominally require operation on the backside of the L/D curve.

i. The vehicle shall be limited to 60 degrees of bank during the subsonic portion of the terminal area phase of flight.

j. The nominal trajectory shall not exceed an azimuth rate of 0.5 deg/sec during the supersonic portion of flight (to avoid sonic boom focal effects).

## A6.0 OMS MANEUVERS

- a. All nominal OMS burns will be two-engine burns with the initial thrust vectors aligned parallel to the X-Z plane and with the combined thrust vector pointing through the c.g.
- b. The minimum OMS delta velocity maneuver is 10 fps for a two-engine burn and 5 fps for a one-engine burn.
- c. Buildup and tail-off losses are assumed to be negligible.
- d. Propellant usage will be based on nominal engine performance.
- e. All usable propellant in the OMS pods and PBK will be available to either OMS engine.
- f. Propellant in the PBK acquisition system will be available to the RCS engines.
- g. Each OMS engine firing will use 94 pounds from under its acquisition screen.
- h. Missions requiring a PBK will deplete the PBK propellant at the first opportunity after the OMS-to-orbit burn.
- i. OMS burns that depleted the PBK prior to completion of that burn will automatically shift to the pod tank.
- j. The OMS engines will not be used for rendezvous braking on mission 3B.
- k. No propellant allowance will be made for increased deorbit requirements due to failure to deploy payload.
- l. No OMS propellant will be dumped or purged from the pods for nominal performance.
- m. Minimum OMS propellant load must cover acquisition screen.
- n. The OMS acquisition system cannot be refilled. This limits propellant for RCS interconnect operations and OMS start to that originally contained in the system.
- o. Minimum altitude for safe engine operation is 70 000 feet.
- p. Minimum engine-off time between firings is 120 seconds.

## A7.0 RCS MANEUVERS

a. Attitude maneuvers will be performed at 0.5 deg/sec except for time critical phases, in which they will be performed at 1.0 deg/sec where acceptable.

b. All attitude maneuver propellant usage will be computed for three-axis Eigen maneuvers unless identified differently for mission operation.

c. No RCS ullage maneuvers will be required.

d. Attitude hold usage will be computed for a minimum deadband of 0.5 degree unless otherwise required.

e. A propellant allocation of 950 pounds will be made for reentry usage. It will be divided equally between the aft pods.

f. It is assumed that the aft pods will be balanced by the crossfeed at all times and that no allowances for RCS pods imbalance will be required.

g. All IMU alinements will require a 3-axis maneuver at 0.5 deg/sec.

h. Propellant usage will be based on nominal engine performance.

i. No reentry propellants will be allotted to the forward RCS tanks.

j. When the interconnect is activated in one pod, the interconnect in the other pod cannot be activated.

k. When the interconnect is activated, it is expected that the ISP will not be degraded.

l. The RCS thrust per engine is a function of the number of engines firing.

m. Maximum steady state firing duration is 150 seconds for the primary thrusters and 100 seconds for vernier thrusters.

n. Maximum number of thrusters firing simultaneously in a single module is 10 primary thrusters (12 for abort) and 2 vernier thrusters.

A8.0 EPS AND ECLSS

a. All consumables tanks are assumed loaded full except the water storage tank. One hundred pounds of water are loaded to provide cooling for once-around aborts.

b. It is assumed that payload bay doors are opened postinsertion and that they remain open until just prior to deorbit.

## A9.0 ATTITUDE AND POINTING

### A9.1 GENERAL

- a. The orbiter will be capable of achieving and maintaining any inertial, local vertical, Earth, orbital object, celestial, or stellar referenced attitude.
- b. The orbiter will be capable of pointing any spacecraft referenced vector to any IMU/navigation base or equally accurate payload sensor referenced attitude  $\pm 0.5$  degree, with an IMU alinement each 1.5 orbits. Orbital object pointing may require higher tracking rates with degraded accuracy.
- c. Payload mounted sensors will provide attitude reference information for additional pointing accuracy since pointing errors greater than 2 degrees can accrue because of vehicle bending and payload-to-navigation-base calibration errors.
- d. Provision will be made to transfer attitude sensor information between orbiter and payload.
- e. An interface will be provided for a payload-supplied pointing and stabilization control system.
- f. The orbiter will be capable of commanding/disabling any payload-supplied stabilization and/or pointing control system.
- g. IMU drift will not exceed 0.1 deg/hr for inertial hold or Earth pointing.
- h. IMU onorbit alinement accuracy will be 100 arc seconds (3-sigma).
- i. The startracker will have a line-of-sight accuracy of 60 arc seconds with a tracking rate of 0.1 deg/sec, and a magnitude sensitivity from +3 to -7 with 0.6 magnitude resolution. Tracking rate capability of 0.5 deg/sec is available with degraded accuracy.
- j. The startracker field of view will be 10 degrees by 10 degrees.
- k. The startracker will not be operational in the tracking mode within 30 degrees of the Sun or within 20 degrees of the sunlit Earth horizon.
- l. The stellar pointing accuracy of the IMU-startracker joint operation will be  $\pm 0.24$  degree, and IMU realinement will not be required for this operational mode.
- m. Earth target pointing requires an IMU realinement each orbit to maintain a  $\pm 0.5$  degree pointing accuracy.
- n. No more than 15 minutes will be required for IMU realinement.
- o. When required and operationally feasible, attitudes will be selected to minimize accelerations due to aerodynamic and gravity gradient torques.

p. When required and operationally feasible, venting and crew motion activities will be limited to achieve required minimal acceleration intervals.

q. Local orbital, body, and instrument pointing coordinate systems will be those defined in "Coordinate Systems for the Space Shuttle Program," TM-X 58153, JSC 09084, dated October 1974.



## A9.2 GN&C FCS

a. The orbiter GN&C/FCS subsystem will provide automatic and manual pointing control capability for all orbital phases except docking.

b. Acceleration control levels will nominally (or for one failure) be  $\pm 0.5$  deg/sec<sup>2</sup> per axis.

c. Acceleration control levels for two failures will be  $\pm 0.2$  deg/sec<sup>2</sup>.

d. Acceleration control for ET attached is required to be  $\pm 1.5$  deg/sec<sup>2</sup> for pitch and roll and 1.0 deg/sec<sup>2</sup> for yaw.

e. Five rate control modes will be available.

(1) Manual direct,  $\pm 0.005$  to  $\pm 0.5$  deg/sec.

(2) Manual proportional rate,  $\pm 0.05$  to  $\pm 0.5$  deg/sec (rate deadbands selectable from 0.05 to 0.2 deg/sec).

(3) Manual discrete,  $\pm 0.01$  to  $\pm 2.0$  deg/sec.

(4) Auto command,  $\pm 0.01$  to  $\pm 0.1$  deg/sec.

(5) Auto barbecue,  $\pm 5$  rev/hr (0.25 to 0.75 deg/sec).

f. Rate control for ET attached is required to be  $\pm 0.5$  deg/sec for yaw and roll and  $\pm 3.0$  deg/sec for pitch. The control accuracy for ET attached is required to be  $\pm 0.1$  deg/sec/axis.

g. Three-axis attitude hold deadbands will nominally range from 0.5 to 10.0 degrees.

h. Three-axis attitude deadbands for the automatic rate command mode will range from 0.2 to 20.0 degrees.

i. Automatic local vertical barbecue mode attitude deadbands will range from 3 to 18 degrees in pitch and yaw.

j. Automatic inertial barbecue mode attitude deadbands will be a  $\pm 15$ -degree-maximum half cone angle.

k. Attitude control requirement for ET attached is  $\pm 0.5$  deg/axis.

l. A stability attitude rate of  $\pm 0.01$  deg/sec/axis and a stability attitude deadband of  $\pm 0.1$  deg/axis will be available, with all vernier thrusters operational and utilizing either the IMU or an equally accurate payload mounted sensor. Propellant for this mode will be chargeable to the payload weight.

m. A stability attitude rate of  $\pm 0.1$  deg/sec/axis and a stability attitude deadband of  $\pm 0.1$  deg/axis will be available, with the primary RCS thrusters operational and utilizing either the IMU or an equally accurate payload mounted sensor. Propellant for this mode will be chargeable to the payload weight.

n. A free drift or passive gravity gradient stabilized mode will be available to satisfy acceleration levels below  $10^{-4}g$ .

### A9.3 ET SEPARATION

- a. Forward RCS thrusters will be deployed after MECO.
- b. Both forward and aft RCS jets will be utilized to obtain a -Z delta velocity of 4 fps for ET separation at ET release.
- c. After ET separation, the RCS jets will be utilized to maintain orbiter attitude hold during the 30-second coast until the two-engine OMS burn ignition.

#### A9.4 PAYLOAD OPERATIONS

a. The maximum payload release errors will be  $\pm 0.5$  degree in attitude,  $\pm 0.25$  deg/sec in tipoff rate, and zero to 2 fps in linear rate.

b. Allowable orbiter dynamics with a payload attached to the manipulator arm consist of a  $\pm 1$  deg/axis limit cycle boundary; a  $\pm 0.75$  deg/sec/axis limit cycle rate; and a  $\pm 1.35$  deg/sec<sup>2</sup> roll,  $\pm 1.35$  deg/sec<sup>2</sup> pitch, and  $\pm 0.73$  deg/sec<sup>2</sup> yaw limit cycle acceleration.

c. Allowable payload dynamics prior to retrieval consist of a  $\pm 1$  deg/axis limit cycle and a  $\pm 0.1$  deg/sec/axis limit cycle rate.

d. The manipulator arm motion will be a 360-degree yaw and a 195-degree pitch at the shoulder joint, a 275-degree pitch at the elbow joint, and a 200-degree yaw and a 240-degree pitch at the wrist joint.

e. The manipulator arm reach capability will be 264.5 inches for the upper arm, 264.5 inches for the lower arm, 71 inches for the wrist, and 24 inches for the end effector.

f. RCS thrusters will be selectively inhibited when feasible to minimize plume impingement on payloads.

g. Relative stationkeeping range and velocity limits are 20 feet  $\pm 2$  and  $\pm 0.1$  fps, respectively.

## A10.0 RENDEZVOUS

a. The desired maximum time between the end of the OMS insertion burn and stationkeeping (approximately 100 feet from the payload) is 25 minutes.

b. An interval of 120 seconds following OMS insertion is required to reconfigure the orbiter for orbital operations.

c. The orbiter initiates a 180-degree roll to a heads-up attitude at a 5 deg/sec rate 2 minutes after OMS insertion. (See sec. 5.2.)

d. Activation of the payload bay doors begins during the roll to heads-up attitude.

e. Two minutes are allowed for deploying the rendezvous radar after initiating payload bay doors open.

f. One minute is assumed to be required for rendezvous radar acquisition of the payload.

g. Terminal control begins 2 minutes after rendezvous radar acquisition.

h. Only the RCS engines are used for rendezvous to avoid breaking rendezvous radar lock-on.

i. Range-rate and line-of-sight corrections are made, component by component, with the use of manual techniques.

j. It is assumed that the rendezvous radar operating in the skin-track mode provides range, range rate, angle, and angular rate information within 10 nautical miles.

k. No lighting constraints were considered in developing the rendezvous sequence.

l. The orbiter ascent guidance can control the relative position at insertion between the payload and orbiter to within the accuracy of the estimated state vectors for both vehicles.

m. The actual insertion conditions and the orbiter G&N system knowledge of the position and velocity at OMS termination are assumed to be the same, with the exception of downrange position. The G&N performance at insertion is as follows (mean + 3-sigma):

R = 4231 feet;      DT = 4067 feet;      CT = 10 168 feet

R = 12.1 fps;      DT = 7.9 fps;      CT = 21 fps

R = radial;      DT = downtrack;      CT = crosstrack

Actual insertion conditions are assumed to be the same as the G&N performance, with the exception that the relative downrange distance between the orbiter and the target is 10 800 feet.

n. The 1-sigma knowledge of the payload position and velocity (based on ground tracking) is assumed to be 3000 feet, 200 feet, and 400 feet (U,

V, W) and 0.2 fps, 0.2 fps, and 3.4 fps (U-dot, V-dot, W-dot) downrange, out of plane, and radially, respectively.

o. The rendezvous is assumed to be executed manually with the use of data directly from the rendezvous radar.

p. The RCS duty cycle is to be minimized for the nominal mission to provide an adequate control authority margin for nonnominal situations; for example, trajectory dispersions, low thrust, and failed sensor. Therefore, the braking gates were chosen to nominally provide a 45-second coast period between range rate corrections for a minimum acceleration level of 0.3 ft/sec<sup>2</sup>.

q. The terminal braking is simulated in a drag-free environment.

r. Braking maneuvers (along the line of sight from the orbiter to the target) are performed with the Z-axis RCS thrusters; additionally, it is assumed that all Z-axis RCS thrusters are available for translation.

s. No attempt is made to bias the insertion velocity to account for the propulsive dump of main engine propellant after OMS termination.

**APPENDIX B - INPUT DATA**

APPENDIX B

INPUT DATA

TABLE B-I.- MECO TARGETS FOR SHUTTLE BRM 3B

WTR SSME cutoff target conditions<sup>1</sup>

Nominal mission

V = 25 278 fps

γ = 0.1°

<sup>2</sup>h = 90 n.mi.

-----  
<sup>1</sup>Target taken from Memo No. FM72 (74-182), "Common Nominal and Common AOA SSME Cutoff Conditions for KSC and WTR Shuttle Launches."

<sup>2</sup>All altitudes are referenced to the Earth equatorial radius.

TABLE B-II.- MASS PROPERTIES SUMMARY FOR SHUTTLE BRM 3B

Item ----	Weight, lb	X-c.g., in.	Y-c.g., in.	Z-c.g., in.
Orbiter dry	15 000	1112.2	0.5	372.2
-----				
(+) Prop. trapped in orbiter	5 281	1410.0	13.1	354.9
(+) Personnel group	2 411	499.3	-6.5	400.1
(+) Nonprop. consum.	4 700	985.8	1.1	354.7
(+) Unusable OMS in integ. tank	557	1444.0	0.0	499.7
(+) Usable OMS in integ. tank	16 108	1438.3	0.0	478.7
(+) Unusable total RCS	394	1125.3	2.1	441.9
(+) Usable fwd. RCS	2 344	316.0	6.1	363.0
(+) Usable aft RCS	4 653	1341.0	0.0	476.7
(+) Launch payload	2 500	940.0	0.0	400.0
-----				
Orbiter at preignition	188 948	1131.9	0.8	384.4
-----				
(-) Prop. trapped in orb. vented	5 281	1410.0	13.1	354.9
(-) Nonprop. consum. (ign. to entry)	335	993.4	-0.5	344.8
(-) OMS from integ. tank	12 845	1454.8	0.0	478.7
(-) OMS from kit #1	-	-	-	-
(-) Aft RCS (L.O. to 400K)	3 297	1341.0	0.0	476.7
(-) Fwd. RCS (L.O. to 400K)	1 653	316.0	6.1	363.0
(-) Payload (launch)	2 500	940.0	0.0	400.0
(-) Payload consumables	-	-	-	-
(+) Payload (landed)	25 000	1038.0	0.0	400.0
-----				



TABLE B-II.- MASS PROPERTIES SUMMARY FOR SHUTTLE BRM 3B - Concluded

Item	Weight, lb	X-c.g., in.	Y-c.g., in.	Z-c.g., in.
Orbiter at entry	188 037	1095.9	0.4	379.0
Orbiter at entry <sup>1</sup>	21 185 675	21109.4	20.3	2377.0
-----				
(-) Nonprop. consum. (400K to landing)	482	1385.4	-14.3	425.3
(-) Aft RCS (400K to landing)	1 125	1341.0	0	476.7
-----				
Orbiter at TAEM	186 430	1093.6	0	378.2
-----				
Orbiter at landing	186 430	1094.8	0.4	375.9

<sup>1</sup>These conditions were selected for entry simulation and do not result from previous events. See text (sec. 4.3) for further explanation.

<sup>2</sup>Data used by FPB for entry.

TABLE B-III.- SHUTTLE WEIGHT SUMMARY FOR SHUTTLE BRM 3B

<u>Item</u>	<u>Weight, lb</u>
(1) Total orbiter at lift-off	188 910
ET inert	75 000
ET usable propellant	(+) 1 550 057
(2) Total ET at lift-off	1 625 057
SRB at SRM ignition	2 562 320
(minus) SRB prop./inert (ign--L.O.)	(-) ----- 9 540
(3) Total SRB at lift-off	2 552 780
Total shuttle at lift-off (sum of (1), (2), (3))	4 366 747

TABLE B-IV.- ATMOSPHERE MODELS FOR SHUTTLE BRM 3B

Mission phase	Model
Launch	WTR atmospheric model as given in "A Reference Atmosphere for Vandenberg AFB, California Annual (1971 Version)" by E. A. Carter and S. C. Brown. NASA TM X-64590, May 10, 1971.
Orbital	MSFC modified Jacchia Model Atmosphere (1965) - appendix B, TM X-53957.
Entry	U.S. Standard Atmosphere, 1962 (US 62) as given in "U.S. Standard Atmosphere, 1962." United States Government Printing Office, December 1962.

TABLE B-V.- ASCENT PROPELLANT SUMMARY FOR SHUTTLE BRM 3B

(a) SRB

	<u>Weight, lb</u>
SRB at SRM ignition	2 562 320
(-) Mass consumed (ignition to lift-off)	9 540
SRB at lift-off	2 552 780
(-) Mass consumed (lift-off to SRB sep.)	2 202 400
SRB at sep. (includes SRM residual propellant = 2080 lb)	350 380

(b) ET

ET empty	71 290
(+) ET residual	<u>3 710</u>
1. ET inert	75 000
(+) ME propellant (from ET) consumed, ignition to lift-off	6 123
(+) ME FPR propellant in ET	2 616
(+) ME fuel bias propellant in ET	1 091
(+) ME unallotted propellant in ET	<u>1 546 350</u>
Total propellant in ET at ignition	1 556 180
(-) ET propellant consumed, ign. to lift-off	<u>123</u>
2. Total propellant in ET at lift-off	<u>1 550 057</u>
Total ET at lift-off (1 + 2)	1 625 057

(c) Orbiter

(+) ME propellant trapped in orbiter (unusable)	2 697
(+) ME FPR propellant in orbiter	<u>2 584</u>
Total ME propellant in orbiter (at lift-off)	5 281

TABLE B-VI.- PROPULSION SUMMARY FOR SHUTTLE BRM 3B

(a) Solid rocket boosters

Physical characteristics

1. Number 2
2. Nozzle exit area 16 665 in.<sup>2</sup>
3. Expansion ratio 7.16:1
4. Throat diameter 54.43 in.

TABLE B-VI.-PROPULSION SUMMARY FOR SHUTTLE BRM 3B

(a) Solid rocket boosters - Continued

SRB thrust time history for WTR (60° F)

Time from lift-off, sec <sup>1</sup> (T/W = 1.5)	Vacuum thrust, klb	Pressure solid motor, psia	Inert weight flow rate, lb/sec	Propellant flow rate, lb/sec	Total weight flow rate, lb/sec
0.0	2930.0	762.0	17.6	11 145.8	11 163.4
0.8	2936.5	764.0	23.2	11 168.0	11 188.3
1.5	2943.0	766.0	23.2	11 190.1	11 213.3
3.0	2985.5	755.5	28.8	11 354.1	11 382.9
4.5	3028.0	785.0	34.4	11 518.1	11 552.5
11.0	3099.0	800.5	35.7	11 792.9	11 828.6
17.5	3170.0	816.0	37.0	12 067.6	12 104.6
18.5	3166.5	814.5	37.2	12 056.6	12 093.8
19.5	3163.0	813.0	37.4	12 045.6	12 083.0
20.5	3113.0	800.0	39.3	11 855.5	11 894.8
21.5	3063.0	787.0	41.2	11 665.3	11 706.5
26.5	2824.0	723.5	46.0	10 758.5	10 804.5
31.5	2585.0	660.0	50.8	9 851.6	9 902.4
41.0	2329.0	592.5	51.4	8 877.8	8 929.2
50.5	2073.0	525.0	52.0	7 904.0	7 956.0

<sup>1</sup>Weight expended prior to T/W = 1.5:

- Propellants 4610 per SRM
- Inert 160 per SRM

-----  
Total 4770 per SRM

Note: Double split flaps per segment are not included in this design.

TABLE B-VI.-PROPULSION SUMMARY FOR SHUTTLE BRM 3B

(a) Solid rocket boosters - Continued

SRB thrust time history for WTR (60° F)

Time from lift-off, sec <sup>1</sup>	Vacuum thrust, klb	Pressure solid motor, psia	Inert weight flow rate, lb/sec	Propellant flow rate, lb/sec	Total weight flow rate, lb/sec
<u>T/W = 1.5)</u>	<u>klb</u>	<u>psia</u>	<u>lb/sec</u>	<u>lb/sec</u>	<u>lb/sec</u>
53.0	2068.5	523.0	49.7	7888.5	7938.2
55.5	2064.0	521.0	47.4	7872.9	7920.3
64.5	2163.5	544.0	45.6	8256.3	8301.9
73.5	2263.0	567.0	43.8	8639.7	8683.5
84.5	2332.5	582.0	43.8	8908.9	8952.7
95.5	2402.0	597.0	43.8	9178.1	9221.9
96.5	2407.0	597.5	43.8	9199.1	9242.9
97.5	2412.0	598.0	43.8	9220.1	9263.9
101.5	2339.5	579.5	37.5	8942.9	8980.4
105.5	2267.0	561.0	31.2	8655.6	8696.8
106.5	2240.0	553.6	28.2	8563.5	8591.7
107.5	2213.0	546.0	25.2	8461.4	8486.6
108.5	2120.5	523.0	23.5	8107.1	8130.6
109.5	2028.0	500.0	21.7	7 7752.8	7774.5
110.5	1935.0	477.0	19.9	7397.0	7416.9
111.5	1852.0	454.0	18.1	7041.2	7059.3
113.5	1658.5	408.5	14.1	6341.7	6355.7
115.5	1475.0	363.0	10.0	5642.2	5652.0
116.5	1377.5	339.0	8.7	5269.1	5277.7
117.5	1280.0	315.0	7.4	4896.0	4903.4
118.5	972.0	239.5	5.6	3717.5	3723.1
119.5	664.0	164.0	3.8	2539.0	2542.8

<sup>1</sup>Weight expended prior to T/W = 1.5:

- Propellants 4610 per SRM
- Inert 160 per SRM

Total 4770 per SRM

Note: Double split flaps per segment are not included in this design

TABLE B-VI.- PROPULSION SUMMARY FOR SHUTTLE BRM 3B - Continued

(a) Solid rocket boosters - Concluded

SRB thrust time history for WTR (60° F)

Time from lift-off, sec <sup>1</sup> (T/W = 1.5)	Vacuum thrust, <u>klb</u>	Pressure solid motor, <u>psia</u>	Inert weight flow rate, <u>lb/sec</u>	Propellant flow rate, <u>lb/sec</u>	Total weight flow rate, <u>lb/sec</u>
120.0	487	120	2.9	1862.0	1864.9
120.5	310	76	2.0	1185.0	1187.0
121.2	190.5	47	1.1	728.6	729.7
121.73	100	-	-	383.0	383.4

<sup>1</sup>Weight expended prior to T/W = 1.5:

- Propellants 4610 per SRM
- Inert 160 per SRM

-----  
Total 4770 per SRM

Note: Double split flaps per segment are not included in this design.



TABLE B-VI.- PROPULSION SUMMARY FOR SHUTTLE BRM 3B - Continued

(b) SSME

Physical characteristics

1. Number 3
2. Nozzle exit area            6464.275 in.<sup>2</sup>
3. Throat area                83.41 in.<sup>2</sup>
4. Expansion ratio            77.5:1
5. Gimbal points and angles  
(orbiter coordinate system), in.

Lower engines	Upper engine
$X_0 = 1468.17$	$X_0 = 1445$
$Y_0 = \pm 53$	$Y_0 = 0$
$Z_0 = 342.64$	$Z_0 = 443$

- MPS lower engines yaw null 3° 30' outboard measured in 10° pitch angle plane; gimbal ±9°
- MPS upper engine yaw null 0°; gimbal ±9°
- MPS upper engine pitch null 16°; gimbal ±11°
- MPS lower engine pitch null 10°; gimbal ±11°

Thrust characteristics (per engine)

Normal power level

	Sea level	Vacuum
Thrust (klbf)	375	470
Specific impulse (lbf-sec/lbf)	362.2	455.2

TABLE B-VI.- PROPULSION SUMMARY FOR SHUTTLE BRM 3B - Continued

(c) OMS

Physical characteristics

1. Number 2
2. Gimbal points and angles  
(orbiter coordinate system), in.

-Y engine	+Y engine
$X_0 = 1518$	$X_0 = 1518$
$Y_0 = -88$	$Y_0 = 88$
$Z_0 = 492$	$Z_0 = 492$

- OMS yaw null  $6^{\circ}30'$  outboard in OMS pitch plane;  
gimbal  $\pm 8^{\circ}$
- OMS pitch null  $15^{\circ}49'$ ; gimbal  $\pm 7^{\circ}$

Thrust characteristics

- |                            |              |
|----------------------------|--------------|
| 1. Vacuum thrust           | 6000 lb each |
| 2. Vacuum specific impulse | 313.2 sec    |

TABLE B-VI.- PROPULSION SUMMARY FOR SHUTTLE BRM 3B - Continued

(d) RCS

Thrust characteristics

1. Main RCS thrusters

- a. Thrust 875 lbf
- b. Specific impulse 289 sec

2. Vernier RCS thrusters

- a. Thrust 25 lbf
- b. Specific impulse 228 sec

TABLE B-VI.- PROPULSION SUMMARY FOR SHUTTLE BRM 3B - Continued

(d) RCS - Continued

Thruster number, direction of thrust, and location

Forward RCS thrusters

Function	Thruster nomenclature	Thruster locations in station coordinates, in.		
		X	Y	Z
-X	132	332.45	+14.00	391.00
	122	332.45	0.00	392.50
	112	332.45	-14.00	391.00
+Y	113	362.50	-52.00	372.50
	123	364.50	-55.00	358.50
-Y	134	362.50	+52.00	372.50
	144	364.50	+55.00	358.50
+Z	135	350.00	+13.00	397.25
	125	350.00	0.00	397.25
	115	350.00	-13.00	397.25
-Z	<sup>1</sup> 136	336.00	+44.00	380.45
	<sup>1</sup> 116	336.00	-44.00	380.45
	<sup>2</sup> 146	350.00	+49.90	382.20
	<sup>2</sup> 126	350.00	-49.90	382.20
-Z (vernier)	<sup>3</sup> 158	326.70	+52.50	364.55
	<sup>3</sup> 157	326.70	-52.50	364.55

<sup>1</sup>Canted 39° outboard.

<sup>2</sup>Canted 35° outboard.

<sup>3</sup>Canted 30° outboard.

TABLE B-VI.- PROPULSION SUMMARY FOR SHUTTLE BRM 3B - Concluded

(d) RCS - Concluded

Aft RCS thrusters

Function	Thruster nomenclature	Thruster locations in station coordinates, in.		
		X	Y	Z
+X	1331	1557.46	137.00	473.44
	1311	1557.46	124.00	473.44
	1231	1557.46	-137.00	473.44
	1211	1557.46	-124.00	473.44
+Y	243	1516.00	-132.50	459.00
	223	1529.00	-132.50	459.00
	233	1542.00	-132.50	459.00
	213	1555.00	-132.50	459.00
-Y	344	1516.00	132.50	459.00
	324	1529.00	132.50	459.00
	334	1542.00	132.50	459.00
	314	1555.00	132.50	459.00
+Z	245	1516.00	-132.00	480.50
	225	1529.00	-132.00	480.50
	215	1542.00	-132.00	480.50
	345	1516.00	132.00	480.50
	325	1529.00	132.00	480.50
	315	1542.00	132.00	480.50
-Z	2246	1516.00	-112.00	437.24
	2226	1529.00	-111.00	440.00
	2236	1542.00	110.00	442.76
	2346	1516.00	112.00	437.24
	1326	1529.00	111.00	440.00
	2336	1542.00	110.00	442.00
-Z (vernier)	257	1565.00	-118.00	457.50
	358	1565.00	118.00	457.50
-Y (vernier)	357	1565.00	143.50	459.00
+Y (vernier)	258	1565.00	-143.50	459.00

<sup>1</sup>Canted up 10° in the X-Z plane.

<sup>2</sup>Canted aft 12° in the X-Z plane and 20° outboard in the Y-Z plane.

TABLE B-VII.- LAUNCH AND LANDING SITE COORDINATES

Western Test Range

Launch site (pad B):

Geodetic latitude = 34.56564 deg north  
Longitude = 120.61970 deg west  
Altitude above Fischer ellipsoid (1960) = 339 ft

Landing site (Vandenberg AFB):

Heading = 316° true

Southeast end of runway coordinates are:

Geodetic latitude = 34.72167 deg north  
Longitude = 120.56500 deg west  
Altitude above Fischer ellipsoid (1960) = 256 ft

Extends to northwest a distance of 15 000 ft, with a slope -8 ft per 1000 ft of length.

TABLE B-VIII.- AERODYNAMICS

Orbiter

"Aerodynamics Design Data Book, Volume I - Orbiter Vehicle,"  
SD72-SH-0060-1G, Revision 1, August 1974.

Integrated vehicle

"Aerodynamics Design Data Book, Volume II - Mated Vehicle,"  
SD72-SH-0060-2G, June 1974.

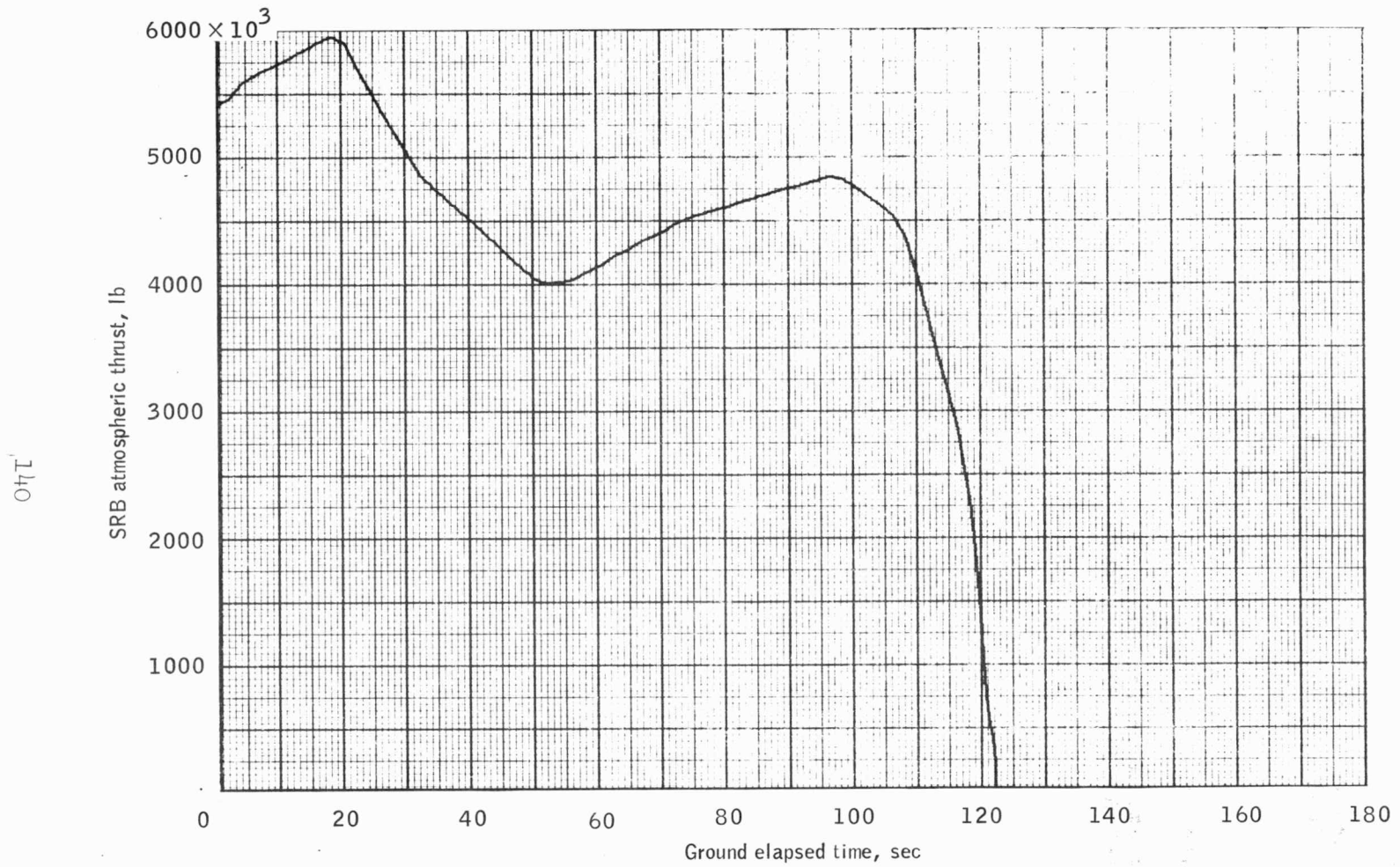

Figure B-1.- Solid rocket booster atmospheric thrust versus ground elapsed time for shuttle BRM 3B.



APPENDIX C - CONSUMABLES SUMMARY

TABLE C-1.- OMS AND RCS LOADINGS FOR SHUTTLE BRM 3B

Propellant, lb	OMS	RCS		
		<u>Forward</u>	<u>Aft left</u>	<u>Aft right</u>
-----	---			
Trapped	557	107	143.5	143.5
Usable	16 108	2344	2326.5	2326.5
	-----	-----	-----	-----
Total	16 665	2451	2470	2470
•-8				

## APPENDIX C

## CONSUMABLES SUMMARY

TABLE C-II.-SHUTTLE BRM 3B PROPELLANT BUDGET

<u>Event</u>	RCS propellant, lb				OMS propellant, lb	
	<u>Used this event</u>	<u>Acc. tot. fore used</u>	<u>Acc. tot. aft. rt. used</u>	<u>Acc. tot. aft. lt. used</u>	<u>Used this event</u>	<u>Acc. used</u>
Attitude hold after MECO	45	15	15	15		
External tank separation (4 fps, -Z)	132	70	54	53		
OMS orbit burn (360 fps)	--	--	--	--	6620	6620
Attitude hold during ascent prop. dump	6	72	56	55		
Sensor acquisition attitude maneuver	91	86	94	94		
Null roll	91	99	133	133		
Pitchdown	19	109	138	138		
Null pitch	19	118	143	142		
Attitude hold at orbital rate	2	119	143	143		
Maneuver to payload line-of-sight attitude	38	133	159	151		
Inertial hold	1	133	159	151		
TPF attitude	38	147	174	160		
TPF braking +Z, 69 fps	1314	620	595	580		

TABLE C-II. -SHUTTLE BRM 3B PROPELLANT BUDGET - Concluded

Event	RCS propellant, lb				OMS propellant, lb	
	<u>Used this event</u>	<u>Acc. tot. fore used</u>	<u>Acc. tot. aft. rt. used</u>	<u>Acc. tot. aft. lt. used</u>	<u>Used this event</u>	<u>Acc. used</u>
+Y, 32 fps	1038	894	789	1151		
-Y, 32 fps	1036	1166	1358	1346		
+X, 13.5 fps	308	1192	1494	1491		
-X, 13.5 fps	287	1476	1496	1493		
+X, 3.75 fps	85	1483	1534	1533		
-X, 3.75 fps	80	1561	1535	1534		
+Y, 3.75 fps	121	1593	1557	1600		
-Y, 3.75 fps	121	1625	1624	1623		
Maneuver to IMU attitude	37	1638	1639	1631		
IMU attitude hold	3	1639	1640	1632		
Maneuver to OMS burn attitude	39	1653	1656	1641		
OMS deorbit burn (328.2 fps)	--	--	--	--	6225	12 845
Entry attitude and control maneuvers	1125	1653	2218	2204		
Total impulse	6075	1653	2218	2204	12 845	12 845

145

## APPENDIX C

### CONSUMABLES SUMMARY

#### NONPROPULSIVE CONSUMABLES SUMMARY

The following tables and figures provide an orbiter consumables summary for the mechanical (APU/hydraulics), environmental, and electrical systems for baseline reference mission 3B. The complete analyses for mission 3B are contained in reference 6. Figure C-1 summarizes the consumables-related sequence of events for mission 3B.

Table C-III summarizes the auxiliary power unit (APU) fuel and the APU/hydraulics cooling water consumables requirements for mission 3B.

The environmental control and life support system (ECLSS) consumables budget is presented in table C-IV. Figure C-2 presents the potable water profile that supports table C-IV.

The mission 3B electrical power system (EPS) energy consumption by subsystem is summarized in table C-V.

Table C-VI presents the power reactant supply and distribution (PRSD) cryogenics summary for mission 3B. Figures C-3 and C-4 show profiles of the oxygen and hydrogen quantities remaining.

Questions concerning these consumables analyses that are unanswered by the detailed analysis document (ref. 6) should be directed to the Consumables Analysis Section (FM7/extension 3458).

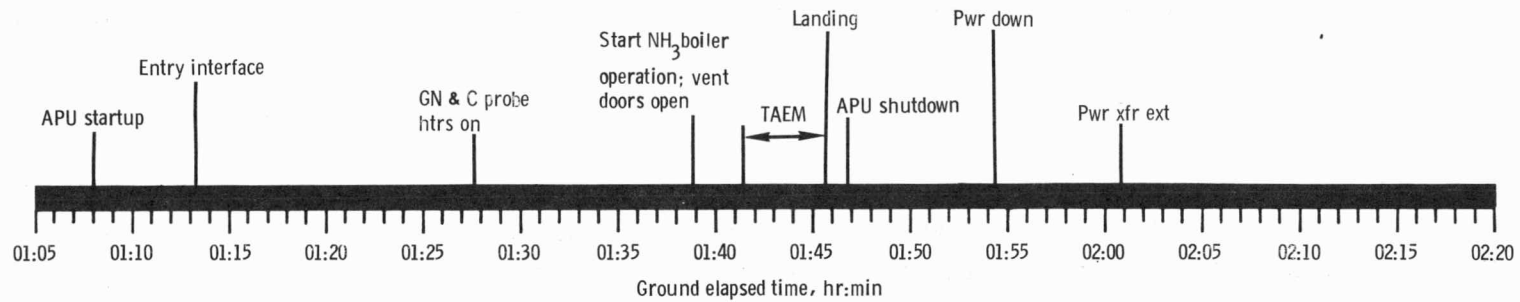
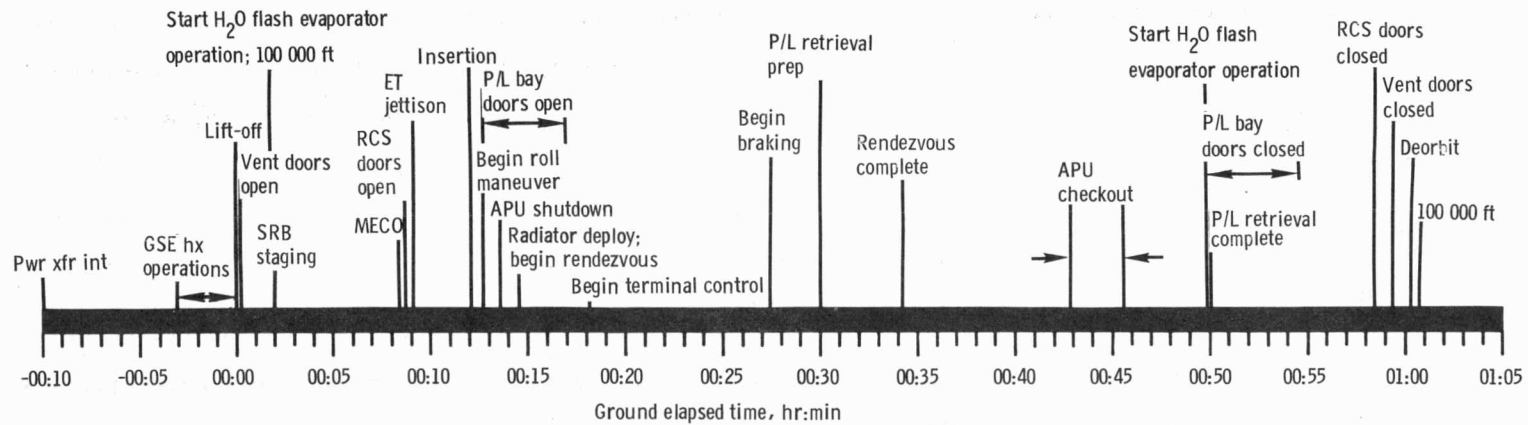

Figure C-1. - Consumables-related sequence of events for shuttle BRM 3B.

TABLE C-III.-APU FUEL AND WATER SUMMARY FOR SHUTTLE BRM 3B

	Fuel, lbm <sup>1</sup>			Water, lbm		
	<u>System I</u>	<u>System II</u>	<u>System III</u>	<u>System I</u>	<u>System II</u>	<u>System III</u>
Present loading:	288.0	288.0	288.0	176.3	176.3	176.3
Unusables:						
• Loading and in-flight measurement errors (RSS)	14.0	14.0	14.0	( <sup>2</sup> )	( <sup>2</sup> )	( <sup>2</sup> )
• Residuals	3.4	3.4	3.4	<sup>3</sup> 36.8	<sup>3</sup> 36.8	<sup>3</sup> 36.8
Minimum usable:	270.6	270.6	270.6	139.5	139.5	139.5
Usable requirements:						
• Prelaunch requirement	13.1	13.3	15.0	.0	.0	.0
• Flight requirement	102.5	109.0	131.1	33.8	36.6	46.3
• Postlanding requirement	1.7	2.4	2.6	.0	.0	.2
• 24-hour-launch-hold recycle requirement	13.1	13.3	15.0	.0	.0	.0
• Dispersions (10%)	13.0	13.8	16.4	3.4	3.7	4.7
Usable margin:	127.2	118.7	90.5	102.3	99.2	88.3

<sup>1</sup>Monopropellant hydrazine.

<sup>2</sup>Undetermined - gauging system not defined.

<sup>3</sup>Includes 15.5 lbm in water boiler wicks, available at reduced heat exchanger efficiencies.

TABLE C-IV.-ECLSS CONSUMABLES SUMMARY FOR SHUTTLE BRM 3B

Item	PRSD oxygen, lb	Auxiliary oxygen, lb	Nitrogen, lb	Lithium hydroxide, # cans	Waste system, lb	Potable water, lb	Ammonia, lb
Amount loaded	112.0	61.0	200.0	2.0	(495.0)	100.0	104.0
Unusable	-	11.0	40.0	-	-	-	-
Requirements <sup>1</sup>							
System operation	-	-	-	-	-	<sup>2</sup> See fig. C-2	79.4
Metabolic support	-	-	-	0.2	N/C	-	-
EVA/IVA	-	-	-	-	-	-	-
Cabin leakage	-	-	0.5	-	-	-	-
Margin	112.0	50.0	159.5	1.8	495.0	<sup>2</sup> See fig. C-2	24.6

<sup>1</sup>Provision for various contingencies has not been identified as being required. Amounts that the various contingencies would consume are provided in reference 6.

<sup>2</sup>Figure C-2 does not reflect metabolic usage.



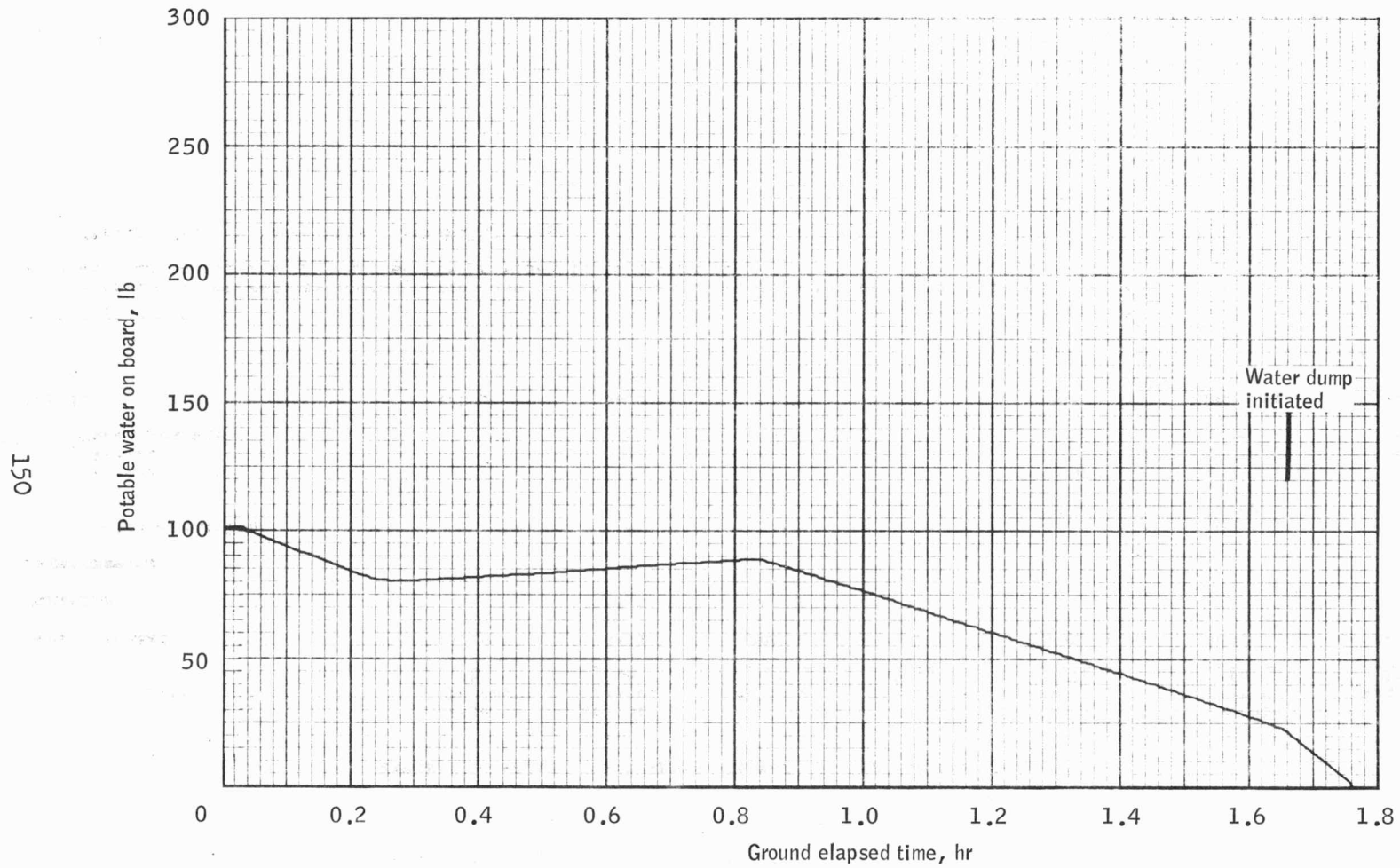

Figure C-2.- Potable water on board for shuttle BRM 3B.

TABLE C-V.-EPS SUBSYSTEM SUMMARY FOR SHUTTLE BRM 3B

<u>Number</u>	<u>Description</u>	<u>kWh consumed</u>	<u>Percent</u>
1	Guidance, nav., and control	.34613941+01	7.7105522
2	Communications	.36289365+01	8.0837671
3	Displays and controls	.78120956+01	17.4021127
4	Operational flt. inst.	.12444552+01	2.7721306
5	Development flt. inst.	.00000000	.0000000
6	Elec. pwr. dist. and control	.30098220+01	6.7046365
7	Data processing	.87811517+01	19.5607684
8	Payload management	.00000000	.0000000
9	Unmanned kit	.00000000	.0000000
15	External kit	.00000000	.0000000
16	Solid rocket booster	.26094873+00	.5812857
20	Main propulsion	.22239310+01	4.9539970
21	Orbit maneuvering sys.	.12631737+01	2.8138277
22	Reaction control sys.	.17510438+00	.3900600
30	Power generation sys.	.13781411+01	3.0699276
31	Cryogenic sys.	.21738482+01	4.8424332
32	Aux. power unit	.77229088+00	1.7203442
40	Envir. control and life sup.	.72123718+01	16.0661764
50	Hydraulics	.37135317+00	.8272210
51	Docking and cargo handlg.	.33049046+00	.7361958
52	Mechanical sys. and lndg.	.79219379+00	1.7646796
60	Payload - 20 ft pallet	.00000000	.0000000
	Total kWh	.44891650+02	

151

Shuttle BRM 3B EPS summary

Total kWh connected to bus	42.7835
Total kWh at the load bus	44.8916
Line losses (kWh)	1.6268
Total kWh at source terminals	46.5184

TABLE C-VI.--SHUTTLE BRM 3B CRYOGENIC SUMMARY

	Hydrogen, <u>lb</u>	Oxygen, <u>lb</u>
Baseline load	184.0	1562.0
Unusables		
• Residual	7.6	46.8
• Gaging error	5.6	48.0
Usable requirements <sup>1</sup>		
• Prelaunch (7.5 hr)	2.7	20.2
• 24-hour hold	1.6	13.9
• Flight		
• EPS	3.7	29.2
• ECS	-	.9
• Dispersion (2.5% EPS)	.1	.7
• Contingency reserve (96 hr)	38.4	304.7
Usable margin	124.3	1097.6

---

<sup>1</sup>The 52-kWh payload energy allocation is not considered.

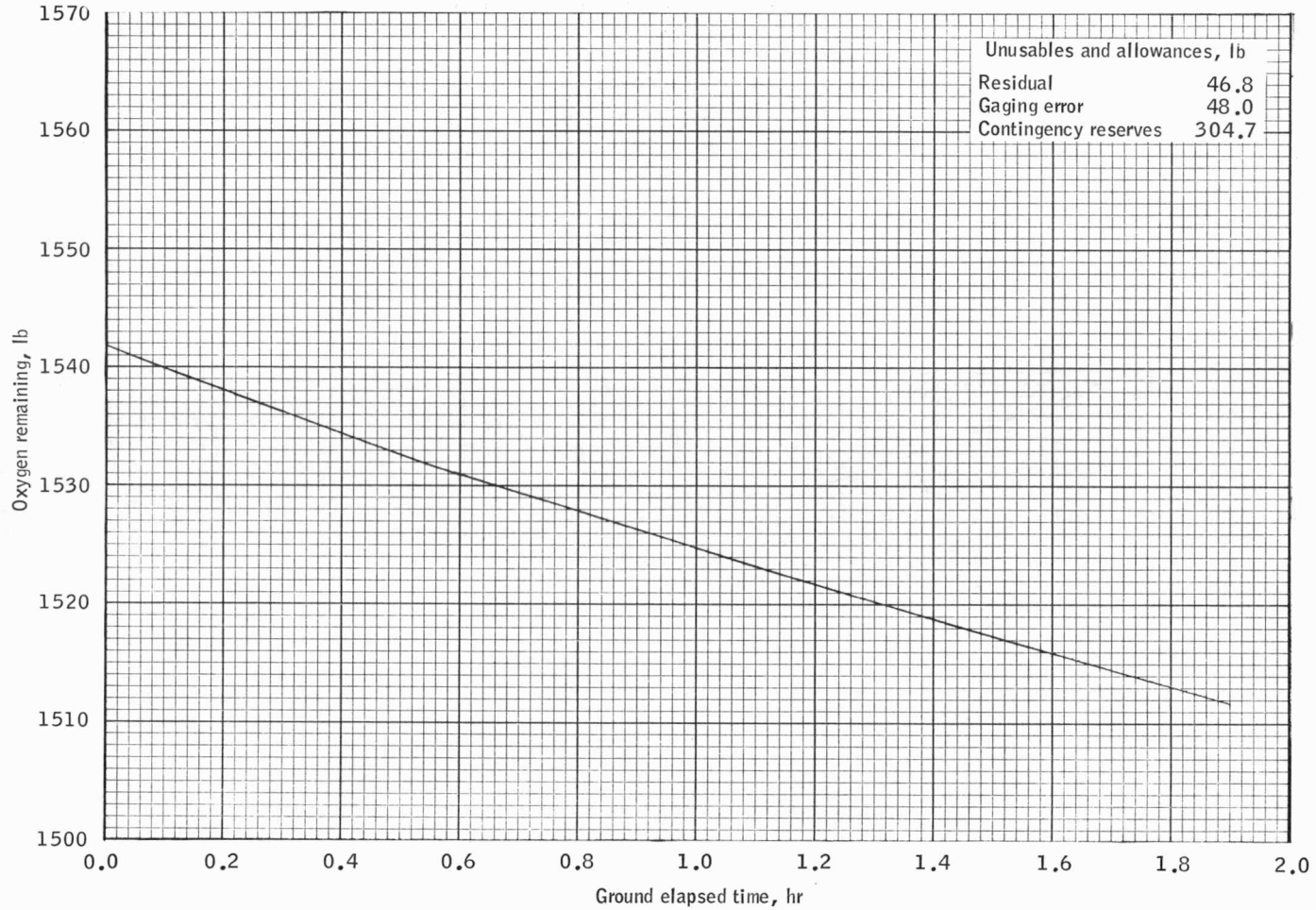

Figure C-3.- Total oxygen quantity remaining for shuttle BRM 3B.

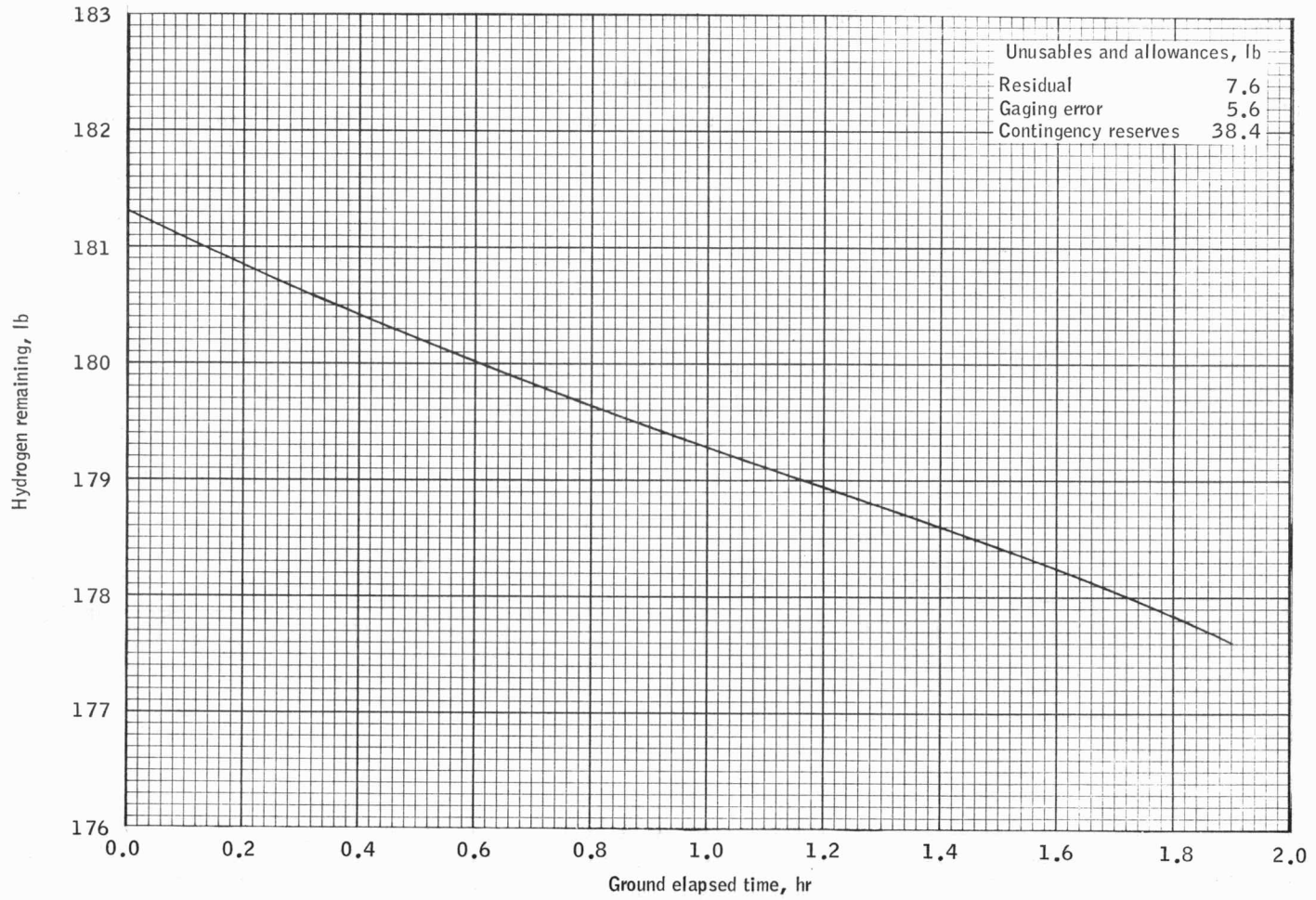

Figure C-4.- Total hydrogen quantity remaining for shuttle BRM 3B.

154  
45T

APPENDIX D - MANIPULATOR TIME LINE FOR RETRIEVAL

## APPENDIX D

### MANIPULATOR TIME LINE FOR RETRIEVAL

The following general assumptions have been made for purposes of this analysis.

#### Payload:

1. Weight = 22 500 pounds (mission 3B).
2. 10-foot diameter by 60-foot length.
3.  $I_{long} = 9500 \text{ slug-ft}^2$  (3B).  $I_{trans} = 220\,000 \text{ slug-ft}^2$  (3B)
4. Grappling point and c.g. 30 feet from end.
5. Payload is designed for rapid retrieval by orbiter; that is, it incorporates built-in grappling and tie-down fixtures, remote RF command receiver for passivation and appendage retraction, and attitude stabilization that can be inhibited remotely after capture has been achieved.

#### Manipulator:

1. 50-foot arm length.
2. 15-pound maximum tip force.
3. Maximum wrist torque 200 ft-lb.
4. Maximum tip speed 2 ft/sec (unloaded), or such that maximum stopping distance is 2 feet (loaded).
5. Maximum angular velocity at wrist 6 deg/sec (unloaded) or 2.8-foot stopping distance of payload extremity (loaded).
6. Linear or angular velocity, profile when moving payload is represented by (1) acceleration at 80 percent of maximum force or torque to desired velocity, (2) constant velocity, and (3) deceleration at 80 percent of maximum force or torque to stop. Perfect control is assumed; that is, deceleration begins at the time necessary to come to rest exactly at the desired end point.

A detailed retrieval time line is presented in table D-I with explanatory notes.

The basic approach to this time line has been a conservative one. Retrieval position is chosen to maximize the time required to achieve it. Thus, if there are no unforeseen contingencies, it should be possible to accomplish the tasks in less time than indicated in tables I and II.

A problem may exist if RCS firings occur while the manipulator is handling a payload. Maximum torque capability of the manipulator joints is presently planned to provide a 15-pound force at the tip when the manipulator is fully extended. If orbiter accelerations cause loads

greater than this, one or more joints will slip, with a resultant temporary loss of control until the acceleration stops. Such a situation could be extremely hazardous. Even if no joint slippage occurs, flexibility of the boom could result in orbiter/payload contact if clearances are small (e.g., while the payload is within the payload bay).

The optimum solution from the standpoint of the manipulator system is to inhibit all RCS firings whenever a payload is attached to the manipulator boom. If, because of mission or system constraints, this is not feasible, the next best approach (from the manipulator standpoint) is to limit RCS thrust to levels that will not cause slippage and to inhibit the system only while the payload is being handled within the payload bay. Rough calculations indicate that firing a single pair of 25-pound thrusters would not cause manipulator slippage with payloads up to about 40 000 pounds. Thus, the problem does not appear to be insoluble, although it should be taken into account in future planning.



TABLE D-I.- RETRIEVAL SEQUENCE OF EVENTS

Event	Start, min:sec	Finish, min:sec	Duration, min:sec
Deploy manipulator	-1:30	0:00	1:30
Retract payload appendages	-	0:00	--
Grapple payload <sup>1</sup>	0:00	1:00	1:00
Null relative velocity <sup>2</sup>	1:00	1:06	0:06
Passivate payload <sup>3</sup>	1:06	4:06	3:00
Move payload to point above bay <sup>4</sup>	1:06	4:42	3:36
Move payload into bay <sup>5</sup>	4:42	8:10	3:28
Secure payload in bay <sup>6</sup>	8:10	9:10	1:00
Stow manipulator <sup>7</sup>	9:10	10:10	1:00
Close payload bay doors	10:10	13:40	3:30

<sup>1</sup>One minute is allowed for grappling the payload after the retrieval position is reached. Simulations of similar operations indicate that this should be adequate for an experienced operator.

<sup>2</sup>Using 12-pound tip force, the payload can be brought to rest 6 seconds after grappling, in a distance of 0.3 foot. The torque resulting from any grappling point/c.g. offset is well within the available wrist torques.

<sup>3</sup>Payload passivation may be accomplished simultaneously with appendage retraction. However, if the stabilization system employs gas jets, this part of the passivation would have to be performed after grappling. On the assumption that the control system could be immediately disabled by RF commands, the tanks could be vented while the payload is being moved into position for stowage. It will be presumed for present purposes that 3 minutes will be sufficient for this operation.

<sup>4</sup>This operation is essentially the reverse of moving the payload to deployment position (3A). The time required is calculated in the same way:

First rotation:

Torque = 160 ft-lb  
 Moment of inertia = 200 000 slug-ft<sup>2</sup>  
 Start/stop distance = 5 degrees  
 Start/stop time = 16 seconds  
 0.65 deg/sec angular velocity for 80 degrees or 123 seconds  
 Total time = 16 + 123 + 16 = 155 seconds

Second rotation:

Torque = 160 ft-lb  
Moment of inertia = 9500 slug-ft<sup>2</sup>  
Maximum angular velocity = 3.1 deg/sec  
Start/stop distance = 5 degrees  
Start/stop time = 3 seconds  
Constant angular velocity for 170 degrees or 55 seconds  
Total time = 3 + 55 + 3 = 61 seconds

Translation:

Distance = 37 feet  
Maximum velocity = 0.26 ft/sec  
Start/stop distance = 2 feet  
Start/stop time = 15 seconds  
Constant velocity for 33 feet or 127 seconds  
Total time = 15 + 127 + 15 = 157 seconds

On the assumption, as for deployment, that the rotations are performed simultaneously, the total time required is 3:36.

<sup>5</sup>Moving the payload into the bay has also been calculated in the same way as its inverse operation (3A). The smaller mass results in a slight time reduction to 3:28.

<sup>6</sup>One minute has been allowed for final positioning of the payload and actuating latch mechanisms. It has been assumed that the orbiter RCS is inhibited during the positioning and stowage operations; otherwise, the task will be extremely difficult, if not impossible.

<sup>7</sup>Since the manipulator completes its function close to the stowage position, 1 minute has been allotted for stowage.

APPENDIX E - TABULAR TRAJECTORY DATA

## APPENDIX E

## TABULAR TRAJECTORY DATA

TABLE E-I.- TRAJECTORY START VECTORS FOR SHUTTLE BRM 3B

Event	Time, Hr:min:sec	Weight, lb	R, ft	V, fps	$\gamma_T$ , deg	Azimuth $\Gamma$ , deg	Latitude $\rho$ , deg	Longitude, deg
Lift-off	00:00:00	4 366 620	20 903 627	1 251.3	0.00	90.00	34.566	-120.620
SRB separation	00:02:02	1 436 646	21 053 701	4 280.4	34.39	179.95	34.226	-120.769
MECO	00:08:29	285 138	21 472 585	25 278.0	0.095	-164.83	22.576	-125.354
OMS ignition	00:09:12	183 502	21 473 518	25 278.0	0.008	-165.117	19.761	-126.339
Insertion	00:12:01	177 057	21 476 507	25 612.7	0.124	-165.838	8.641	-129.990
Start of deorbit	01:02:00	194 243	21 516 827	25 586.7	0.0032	-14.512	15.084	31.532
End of deorbit	01:04:42	188 018	21 496 064	25 407.1	-0.6345	-15.794	25.733	27.782
Entry interface	01:14:28	185 675	21 270 126	25 655.2	-1.0199	-32.557	62.867	2.747

## REFERENCES

1. Davis, L. D.: Coordinate Systems for the Space Shuttle Program. NASA TMX-58153, 1974.
2. Nolley, J. W.: Mission 3B MECO Conditions Selection Trade Study. JSC Memo No. FM72 (74-158), Sept. 1974.
3. Thompson, R. P.: A Study of Maritime Mobile Satellite Service Requirements Frequency Planning, Modulation and Interference Analysis, Volume I: National and International Merchant Vessel Population and Distribution: Present and Forecast. United States Department Commerce PB 196029, Sept. 15, 1970.
4. Flight Performance Branch: Preliminary Formulation of the Shuttle Deorbit Targeting Processor. JSC IN 74-FM-73, Oct. 1974
5. Harpold, J.: Analytic Drag Control Entry Guidance System, Revision 1. JSC IN 74-FM-25, Jan. 1975.
6. Consumables Analysis Section: Electrical, Mechanical, and Environmental Consumables Analyses for the Shuttle Baseline Reference Missions. JSC IN 75-FM-23, May 1975.

73-FM-47, Volume IV, Revision 2  
MPAD SHUTTLE BASELINE REFERENCE MISSIONS DISTRIBUTION  
(Revised June 18, 1975)

Aerospace/Dr. S. T. Chu  
CA/K. S. Kleinknecht  
CB/J. W. Young  
CF/M. P. Frank  
    C. Beers  
CF3/D. Puddy  
CF4/C. R. Lewis  
CF5/J. D. Shannon  
CF6/N. B. Hutchinson  
CF7/W. L. Peters  
CG/J. W. Bilodeau  
CG5/T. Holloway (2)  
CG6/W. M. Merritt  
CH2/W. C. Burton  
CSDL/N. Sears  
EA/M. A. Faget  
EC/L. E. Bell  
EE/R. W. Sawyer  
EE6/J. W. Griffin  
EG/R. G. Chilton  
EG3/Don Brown  
EG8/R. E. Wilson, Jr.  
EJ/W. C. Bradford  
EJ3/K. J. Cox  
EJ5/R. E. Daly  
EJ6/P. C. Kramer  
EJ12/C. F. Wasson (2)  
EP/R. B. Ferguson  
    J. G. Thibodaux  
ES/R. E. Vale  
ES12/W. G. McMullen  
EW/W. W. Petynia  
EX/B. G. Jackson  
    Bass Redd  
FA/H. W. Tindall, Jr.  
    R. G. Rose  
FD/C. Huss  
FE/C. Woodling (2)  
FM/Author(s)  
FM/R. L. Berry  
FM2/J. J. Taylor (2)  
FM3/R. H. Brown (2)  
FM4/M. Jenkins (2)  
FM5/J. Funk  
FM7/R. O. Nobles (3)  
FM8/E. Schiesser (2)  
FM13/R. E. Simms (51)  
    K. Henley  
FM14/Report Control Files (75)  
FR/R. Parten (3)  
FS/J. C. Stokes (2)  
FS4/D. T. Myles  
FS5/J. L. Hall  
JM2/Center Data Management (3)  
JM6/Tech. Library (2)  
KSC/SP-MGR/Dr. R. H. Gray  
LA/R. F. Thompson  
LA2/O. G. Morris  
LA5/D. C. Cheatham (5)  
LA22/J. W. Harden  
LA24/R. P. Burt  
LARC/418/C. P. Llewellyn  
LE/E. Jones  
LM/A. A. Bishop  
LO/A. R. White  
LP/J. C. Heberlig (2)  
LT/F. Bennett  
    R. H. Kohrs  
LV/J. B. Jackson, Jr.  
MA/A. Cohen  
    F. W. Haise  
Martin Marietta-Denver/C8801/B. Brown  
MDAC/Houston/W. Hayes (2)  
ME/R. W. Kubicki  
    R. M. Moore  
MFSC/SA31/J. B. Odom  
MMC/Michoud/J. D. Walker  
MSFC/SP-MGR/R. E. Lindstrom (2)  
    SP-EM-MGR/J. M. Sisson (2)  
MSFC/O. C. Jean/PA01  
    R. E. Lindstrom/SA01  
    T. J. Lee/NA01  
Bill Davidson/NASA Rep.  
    ESTEC/Noordwijk, Holland  
NASA Hdq/MHO/E. P. Andrews  
NASA Hdqs/MHO/E. W. Land, Jr.  
    MH/Dr. M. S. Malkin (2)  
NS2/N. R. Schulze  
SAMSO/Houston/ZR1/Col. L. D. Bowles (4)  
SAMSO/LVR/Dr. R. Collins  
    LVRD/Col. B. V. Clark (2)  
    LVRD/Lt. Col. J. C. Marshall (2)  
    Capt. D. Keach  
WA/D. D. Arabian  
WB3/Program Office Files  
WC3/M. Collins  
IBM/59/W. Bridges (5)  
FS15/T. W. Sheehan