

CSDL-81-624

MAN-COMPUTER INTERFACE FOR THE APOLLO GUIDANCE,

NAVIGATION, AND CONTROL SYSTEM

J. L. Nevins and I. S. Johnson

INSTRUMENTATION LABORATORY,

MASSACHUSETTS INSTITUTE OF TECHNOLOGY

CAMBRIDGE, MASSACHUSETTS

An informal presentation to be made at the USC - NASA Conference on
Manual Control to be held at the University of Southern California,
March 1 - 3, 1967.

Purpose

The purpose of this presentation is to describe the man-computer interface for a complex problem, where the interface has been sized by the usual spacecraft design constraints.

Introduction

Apollo is the first manned U. S. spacecraft that contains enough sensors and data processing capability to allow the crew to navigate and guide their spacecraft from the "on board" equipment only.

Navigation and guidance for Apollo can be described as a problem in fuel management of very high accuracy. To obtain the data, optical, force, and attitude measurements of high precision are required. This data must then be processed and the results communicated in some convenient form to both the crew and the ground. In addition, the design must be very efficient because the spacecraft is as limited in electrical power, weight, and volume as it is in fuel.

In order to describe the man-computer interface problem, it will first be necessary to briefly define the problem. This presentation is therefore organized along the following lines:

First, general description of the Apollo guidance and navigation system.

Second, description of the basic man-computer interface including the basic operations.

Third, use of the computer during a mission including a brief movie of some typical operations.

A. Navigation, Guidance, and Control for the Apollo Program

Descriptions of the primary guidance and navigation (G&N) system for the Command and Service Modules (CSM), and the Lunar ~~Excursion~~ Module (LEM) have previously been given in References 1, 2, 3, and 6. Therefore, this section will only briefly summarize this system.

The G&N system has the capability to control the spacecraft path throughout its mission which, for the basic lunar landing mission illustrated in Figure A1 contains fifteen distinct guidance and navigation phases. Also required, Figure A2, is the capability to guide aborts from all phases prior to trans-earth injection. In order to perform these functions, three distinct tasks must be accomplished.

1. Determine position and velocity on present spacecraft orbit.
2. Compute future spacecraft orbit or landing point and the initial conditions for the required maneuver.
3. Control application of thrust or lift so as to achieve the desired new orbit or landing point.

Tasks 1 and 2 are performed periodically during free fall phases - an activity we refer to as navigation. Task 3 is performed continuously during powered maneuvers - an activity we refer to as guidance. Guidance of the Apollo Spacecraft is inertial, i. e. applied force is sensed by accelerometers mounted on a gyroscopically stabilized platform and processed by a computer which generates steering and engine cut-off commands. (Figure A3). The Lunar ~~Excursion~~ Module G&N system also utilizes radar and astronaut-visual inputs during the final approach to landing and therefore the LEM may be said to use radar-visual-inertial guidance.

Navigation Sensing

Navigation angle data in cis-lunar space is obtained by a two line-of-sight instrument called a space sextant. This instrument is fundamentally designed to measure the angle between a selected star and an earth or lunar landmark. The astronaut senses both the star and the landmark visually (refer to Figure A4 and A5) and controls the instrument to track both with the aid of servo drives and spacecraft attitude control.

Additionally, the sextant may contain photometric sensors for automatic star tracking and detection of light in the visual band radiated from the atmosphere at the earth's bright horizon. These features illustrated in Figure A6 permit acquisition of navigation data when earth landmarks are obscured by cloud cover or when a fully automatic guidance and navigation capability is desired. Single line-of-sight operation to track stars provides the orientation data required for alignment of the inertial platform.

The space sextant is a two line-of-sight instrument shown schematically in Figure A7 designed and used very much like the conventional mariner's sextant. It is operated to superimpose a star on a landmark at which time the angle is read out electronically into the computer. The navigation process uses a sequence of these angle measurements to update the present best estimate of position and velocity in a statistical sense (ref. 4 and 5).

In local orbit, the star-landmark angle rate of change is too great for measurement by the sextant. In this case, a single line-of-sight, wide field instrument called the Scanning Telescope is used to track landmarks. (Figure A8). The direction of the tracking line with respect to the inertial platform is read into the computer which processes this data to update the local orbit ephemeris. Such a bearing "fix" locates the spacecraft on a

line in the direction of the line-of-sight and terminating at the landmark. The Scanning Telescope is also required as a finder for the Sextant. In addition, the SXT may be used in local orbits (earth or moon) to track unknown landmarks. This technique has an obvious application on the back side of the moon or when the earth is covered by clouds.

For rendezvous, navigation sensing is accomplished with a radar on the Lunar ~~Excursion~~ Module tracking a transponder on the mother ship. A back up and monitor capability will be provided by the SXT on the mother ship tracking a light on the LEM.

Figure A9 summarizes the navigation phases in a typical mission, while Figure A10 summarizes the guidance phases in a typical mission.

Equipment Description

To sum up, navigation in deep space requires three things.

- a. Optics to make sightings
- b. A data processor
- c. Guidance which requires:
 1. Gyros for attitude reference
 2. Specific force instruments for measuring non-field forces.
 3. Optics for aligning the gyros

Of course, we require engines for making velocity changes and a vehicle stabilization system to neutralize vehicle dynamics. For rendezvous maneuvers, we also need radar in order to get range, range rate, and line-of-sight information.

The primary G&N system consists of the following basic units in CSM and LEM installations:

CSM Installation

IMU Inertial Measurement Unit
AGC Apollo Guidance Computer
PSA Power Servo Assembly
CDU Coupling Data Units
SXT Sextant
SCT Scanning Telescope
D&C Display and Control

LEM Installation

IMU Inertial Measurement Unit
LGC LEM Guidance Computer
PSA Power Servo Assembly
CDU Coupling Data Units
AOT Alignment Optical Telescope
D&C Display and Controls
RR Rendezvous Radar
LR Landing Radar

Apollo Guidance Computer

The AGC (References 8, 9 and 10) is the central processor for the guidance and navigation system. It is also the clock or basic time and frequency reference for the spacecraft. Figure A11 shows the inter-relationship of the AGC to the various sensors and to the spacecraft control and propulsion system for the CSM digital autopilot function.

The AGC can also communicate with the sextant and scanning telescope via the Coupling Data Units (CDU' s). It can also communicate with the displays and it can receive inputs from the astronauts via the keyboard. In addition, the AGC can count pulses from the accelerometers, read gimbal angles and read and control radar angles. The AGC can send information to earth via telemetry and receive telemetry information on an uplink. During guidance modes of operation, the AGC can control and stabilize the spacecraft and start and stop the engines.

Two computers have been designed a Block I and a Block II. The Block II is a more powerful version of the first design. Figure A12 shows the Block I computer and its associated Display-Keyboards (DSKY' s) and

Figure A13 shows the Block II computer and associated DSKY's. Figure A14 lists the characteristics of both computers.

The equipment is mounted in the CSM, as shown in Figure A15. The location of the equipment for the LEM is shown in Figure A16. Figure A17 shows a Block I system under test at the Instrumentation Laboratory at MIT, while Figure A18 is a Block II system undergoing tests.

Man-Machine Interfaces

Design Philosophy

The usual discussions concerning the man-machine interface can be broken down into two categories; unfortunately, both cases usually represent extreme points of view. One point of view, illustrated by Figure A19, is the "fully automatic" system where the astronaut, wrapped in a life maintaining cocoon, is delivered to the lunar surface. The only real problem here is keeping him entertained during the mission. The other point of view, illustrated by Figure A20, is the "fully manual" system where the astronauts are given a rocket, a big window, a control stick, and appropriate charts and tables. This technique is certainly feasible in infinite energy type of vehicles (an airplane with inflight fueling certainly falls within this classification) but becomes questionable for finite energy vehicles such as Apollo where highly accurate and complex navigation systems are needed to determine the most efficient path, or orbit, to the moon and back.

Instead of the two extremes quoted above, we would like to substitute a third category. This third category could be called "manually aided" systems and would combine the best features of both the man and the machine.

In order to illustrate this point of view, Figure A21 shows the functional relationship of the man to the spacecraft for a typical midcourse star-landmark angle measurement. For this task, the following things are expected of the man.

- a. Acquisition and identification of a particular star and landmark. To do this, he must be able to maneuver the spacecraft via the control system. Also he must perform the pattern recognition problem of associating the desired star and landmark patterns from maps and charts to the real world beyond his optics.
- b. He must be able to operate the displays and controls associated with the optics to position the desired landmark into the sextant field of view.
- c. He performs the superposition of the star on top of the landmark, to the accuracy needed, and "marks" this event to the computer which notes the time of the mark and the angle.
- d. Monitor and communicate with the on-board data processor as it processes his and other data and solves the complex functions necessary in order to navigate and guide the spacecraft to the moon.

Thus, we have employed man in three major levels of activity. In the first level, he performs his major role of monitoring the on-board data processor. In the second level, he solves a complex pattern recognition problem which would be costly in weight and system complexity to instrument. In the third level, he performs the fairly routine mechanical job of accurately pointing the optics. Again, instrumenting this problem would add weight and system complexity.

Another facet of this discussion is the question of control or sequence of operations. Here again, man possesses unique abilities in

assessing the proper operation of his equipment and the optimum course of action. Again, the equipment can aid the man by doing a lot of routine sequencing associated with the many spacecraft tasks. At least it could check the sequencing to make sure that it had been performed and that it was done according to the checklist.

On this level, the man and machine think exactly alike. They each need a predetermined checklist, or logical path, and then a display, or signal, or order to confirm the event. If both perform the total sequence, the overall mission reliability goes up. At a minimum it allows man to sit back and modify the sequence, as necessary, to meet the myriad of possible contingencies. Only man is capable of executing the judgement necessary to perform a successful mission in the presence of unexpected and unplanned for difficulties.

In summary, then, manually aided systems make maximum use of the unique but distinctive abilities of man and equipment. This combination, we feel, minimizes the weight and complexity of the equipment and maximizes the reliability.

B. Man-Computer Interface

The rest of the paper will be devoted to describing the man-computer interface. The discussion will be along the following lines:

- a. Physical description of the computer display-keyboard (DSKY) unit and its basic operations.
- b. Description of the DSKY use in mission operations.
- c. Summary.

The two DSKY's (Block I and II) are shown in Figure A12 and A13. The two are functionally the same, except for the following; in Block I, a finer detail of internal computer caution signals were brought out on the LEB DSKY; while in Block II, a larger group of functional signal lights are displayed. Note: The same Block II DSKY is used twice in the CM, on the main display console (MDC) and in the LEB (Figure A15). In the LM, the same DSKY appears on the Main display panel (Figure A16).

The remainder of the descriptions will be devoted to Block I because that is the one for which I have a movie. The differences between Block I and Block II will be pointed out as I go along.

Physical Description

Each DSKY consists of a keyboard, relay matrix with associated decoding circuits, displays, alarm circuits, and power supply. The keyboard, which contains numerics, signs, and other control keys, allows the astronaut to exercise control of the AGC. The inputs from the keyboard are entered into an input register and are not processed by the AGC until the enter key is actuated.

The displays, which are electroluminescent, perform the following functions: (1) display data, (2) identify the data, and (3) monitor certain functional discretes. Data is displayed in three five decimal, or octal, digit registers. Associated with each register is a sign bit for the display of decimal data. In addition memory locations may be addressed directly,

but this is intended primarily for ground checkout. We might point out that there is no attempt to restrict the access of the crew to the computer. However, we primarily train them to use the technique designed for flight operations. For flight operations, data is displayed in two levels (reference 11). The highest level is a two-digit decimal code called a program identifier.

Programs are major functional operations (Figure B1) where the most significant digit is strongly related to mission phase. For example, the zero series are the pre-launch programs; the ten series are the boost monitoring programs; the twenty series are the navigation programs; the thirty series are the targeting programs for changing orbits, rendezvous, etc. ; the forty series are concerned with the guidance for thrusting and the starting and stopping of the engines; the fifties are concerned with inflight alignments of the inertial sensors; the sixties with entry; and the seventies with aborts.

The unit programs define the functional programs within a particular series.

The second level of addressing consists of two 2-decimal digit identifiers called appropriately Verb and Noun. The intent of the Verb identifier is to define an action. The Noun identifier modifies the action of the verb and identifies the data being displayed or loaded. (Figure B2) lists some examples of verbs and nouns.) For example, Verb 16 means the computer will continuously monitor a function, display the data in decimal form, and update the display every half-second. If we associate with that Noun 16, then we will have displayed the AGC clock expressed in ground-elapsed-time (GET), with hours in the first data register, minutes in the second data register, and seconds to hundredths of a second in the third data register. Another example is Noun 40, which is the noun used just prior to and during an actual thrusting maneuver. In the first data register, the time-to-ignition is displayed in minutes and seconds. In the second data register is displayed the magnitude of the velocity-to-be-gained. The third register

displays the magnitude of the velocity measured by the inertial components during the thrusting maneuver.

Communication with a computer always is bimoded, i. e., the man talking to the computer, and the computer talking to the man. The latter mode is mechanized by allowing the computer to flash the verb-noun displays (flash rate 1/2 second on, 1/2 second off). Therefore, if the computer wants the man to review data for acceptance or rejection or to load data, it will flash the appropriate verb-noun combination. For example, to load registers of data, the man would select a V25 N--E. As soon as he keyed the enter, the verb register displays a flashing V21 and the first data register is blanked, permitting the man to read the data as he enters it. Note again that this data is not recognized by the computer until the "enter" has been keyed. As soon as the enter is keyed on the first register of data, the flashing verb will now change to 22, and the second data register will be blanked. This process is then repeated for the third register. More interesting examples will be given during the movie.

In addition there are "activity" lights for both the computer and the telemetry uplink, and alarm lights for both computer and the rest of the inertial system. In Block I the G&N system lights were located in the caution and warning array in the MDC. In Block II they were consolidated in the DSKY.

Mission Operations

The computer programs are designed to require continuous or discrete monitoring by the crew. In addition, sequencing of the associated S/C system functions such as engine thrusting may be performed by the crew with monitoring by the AGC. The crew must also review the initial computational parameter for all G&N system maneuvers including spacecraft attitude,

thrusting, and entry.

To illustrate these processes we will examine in some detail these programs:

- a. Portions of Program P24 - Ground Track Determination
- b. Program P52 - Inertial component alignment including automatic optics point routine.
- c. Portions of Programs P31 and P41 - P31 is the Pre-Thrusting program for an orbit change and P41 is the Thrusting program.

Figure B3 outlines program P24. Of interest are the routines initiated by Verb calls (V 64) and (V 66). When the crew keys V 64, the program number changes to 24 and the computer integrates the S/C state vector, stored in the computer with its associated time tag, to the present time. The computer activity light comes on and the computer sits and thinks for awhile. When a solution is reached, the AGC displays a flashing V16 N 43 and displays the apogee and perigee altitude of the present orbit in nautical miles and the time-to-go to the point where the spacecraft orbit would intersect 300,000 feet if the perigee were low enough (so called time-of-free-fall). The display is 59 min. - 59 sec. for a stable orbit.

At this point the computer holds the flash until the crew-man indicates he is through reviewing the data by keying a proceed (V33E). The computer then displays the time to the next perigee (N45). (Note: The time-to-perigee is measured from the instant N43 is displayed). Again the crew-man reviews the data and gives a proceed when he is through. At this point the routine is finished and the DSKY is cleared except to display the idling program (P00). During program P00 the computer performs a continuous automatic self-check.

Crew keying of V66 selects another routine in P24. The first call in

this routine is a flashing V21 N34 which requests the crew to load the ground elapsed time for which he desires the S/C Latitude, Longitude, and Altitude. That is, the program will calculate and display a point on his ground track. Note: He may load any time (present, past or future). Once the time is loaded the computer updates the state vector to the specified time. After it is through thinking, it flashes V06 N44, displays the Latitude, Longitude, and Altitude of the orbit at the desired time. When the crew-man is through reviewing the data, he keys a proceed. A proceed in this routine causes the state vector to be recomputed and displayed for a time ten minutes beyond the initial time. Additional proceeds update the ground track in ten minutes increments. This routine is terminated by keying the terminate code (V34E).

To summarize, we have shown how programs are called, the formats for displaying data, and some of the ways the crew can step through the programs. Table I lists the possible crew keyboard codes.

The next program (P52) illustrates additional facets of the interface.

Program 52 is selected by using the program selection verb (V37). This verb is the primary way of selecting or redesigning new programs (except for P24 which is really a collection of routines that can be called by individual verbs). Thus P52 is selected by a V37E 52E.

The outline of P52 is shown in Fig. B4. In these outlines we are trying to show the program sequence with the various options for the crew's reloading new data, recycling to an earlier point within the program and/or terminating that program and selecting other programs.

The purpose of P52 is to check or re-establish the orientation of the inertial components in space. In this program the pointing angles of the optics at specified stars are noted by the computer to establish the desired

reference coordinates. As soon as P52 is selected the computer selects two stars from a stored list of 37 coded navigation stars. The routine selects the stars on the basis of their being simultaneously visible in the SCT cone of view and having a maximum angular separation, in order to optimize the sighting mark information. In addition, the routine checks to see that they are not occulted by sun, moon, or earth. The stars may be acquired manually or by computer control of the optics. When the star is centered on the optics reticle the navigator sends a mark signal to the computer. One such mark on each of two stars provides enough information to establish the inertial sensor orientation. After the two sighting marks, the computer calculates the actual angle between the stars (from the star positions stored in memory) and the angle between the stars from the sighting mark data and displays the difference between these two values. This data provides two checks. One, that the crew-man sighted the correct stars, and two, that his pointing was sufficiently accurate. If this angle error is satisfactory, the AGC automatically drives the inertial sensors to the desired orientation.

The navigator keys V37E52E to select the inertial orientation program, P52. The AGC displays the first of two selected stars. The navigator accepts the star with a proceed (V33E) and the computer requests the navigator to select computer control of optics positioning for star acquisition. The navigator accepts by placing the optics mode switch to computer mode and keys ENTER to start the automatic optics positioning. As the AGC drives the optics, it simultaneously flashes V51, requesting a sighting mark. The navigator verifies that the proper star has been acquired, takes over manual optics control, centers the star image on the SXT reticle and marks.

The AGC requests termination of the sighting mark sequence, but the

navigator may reject a poor mark by keying V52E and the AGC again requests a mark. After a good mark, the navigator keys ENTER to terminate the mark sequence. The navigator then loads the code of the star marked and the entire sequence is repeated for the second star. In the movie, the navigator chooses to acquire the second navigation star manually. After receiving the second star code subsequent to a good mark, the AGC displays the marking accuracy data. If this value were greater than $.05^{\circ}$, the navigator would have to decide to proceed with this data; if less than $.05^{\circ}$, the data is automatically accepted by the AGC and automatically torques the inertial sensors to the desired orientation and displays the angles through which the sensors are driven. The AGC then requests an alignment check consisting of a repeat of the entire sequence, which the navigator may reject.

To summarize, P52 illustrates navigator optical measurements upon request of the computer with the "please mark" verb (51); that the computer checks the data and can be forced by the navigator to accept larger than nominal errors (step 15); that the AGC checks that the crew have set the control switches for proper program execution (step 5); and that the AGC notifies the crew of improper mode selection or sequencing.

We will now turn to our final examples - the pre-thrusting program P31 and the thrusting program P41. The outlines for these programs are shown in Figures B5 and B6.

The objective of Program 31 is to calculate and display the apogee and perigee of a new orbit, the fuel consumption, and S/C attitude required to achieve that new orbit, based on the following crew inputs: (1) ignition time, (2) aim point coordinates, (3) period of new orbit, and (4) thrust engine gimbal angles to compensate for c. g. shifts and thrusting engine tail-off

characteristics. (This last factor is required because, for program simplicity, the computer assumes a step function burn cut-off, which does not actually occur.)

Having decided the nature of the orbit change, the crew may determine the above values by means of the orbital parameter determination program (P24) and charts provided in the on-board data package. The aim point coordinates may be determined, for example, by keying V66E, and loading a time about 1/4 period beyond ignition time. The computer calculates the S/C coordinates for this time. The aim point is selected about 1/4 after ignition time to minimize dispersions in computer calculations of the new orbit.

The crew selects the pre-thrusting orbit change program P31 by keying V37E31E. The AGC first displays a time of ignition, which the operator may change by keying V25E and loading the appropriate data. Notice that when the "enter" subsequent to V25 is keyed, the Verb register displays a flashing V21, and the first data register, R1, is blanked. After the "enter" subsequent to the data loaded in R1, the Verb register changes to a flashing V22 and R2 is blanked. When the operator is satisfied with the data loaded he may proceed to the next data display, aim point coordinates. The estimate of the period of the new orbit is loaded next, followed by loading of thrust engine gimbal angles and cut-off bias.

The AGC computes and displays the resultant apogee and perigee and fuel (in feet per second) to achieve that orbit. If these values are not satisfactory the program may be reselected and the data adjusted. Subsequent displays for time to ignition and inertial gimbal angles at thrust are provided when the operator keys proceed (V33E). If these are satisfactory, the S/C is positioned either manually or by the AGC at the desired thrusting orientation. The thrusting program P41 is then entered. In this program ~~the~~

the engine ignition and shutdown are controlled by the crew through the computer and the resulting orbital parameters are displayed after the burn.

Summary

In summary, we have described a man-computer interface design for a family of space-oriented tasks which can be generalized as shown in Figure B-7.

The cost of the interface in terms of computer memory capacity is about 8%. In terms of computer weight the DSKY represents about 19% of the total weight.

TABLE I

Crew Keyboard Control of
Computer and Mission Sequences

Operation

(1.) V37E ^{XX} E	Select program specified by code XX.
(2.) V--N--	Perform function defined by Verb code with and/or upon values defined by Noun code.
a.) V16 N ^{YY}	Monitor continuously updated data display defined by Noun Code, YY.
b.) V2- N--	Enable load data into computer.
(3.) V33E	Proceed to next step in program.
(4.) V32E	Recycle to head of program or subroutine.
(5.) V34E	Terminate sequence.
(6.) ENTER	Complete data load, program selection, or crew option specified by computer display.
(7.) CLEAR	Erase improperly keyed data.
(8.) RESET	Acknowledge awareness of improper keyboard procedure.
(9.) KEY RELEASE	Permit computer to regain requested control of keyboard.

REFERENCES

1. D. G. Hoag, "Apollo Guidance and Navigation - A Problem in Man and Machine Integration", MIT Instrumentation Laboratory Report R-411, April 1963, given at the AIAA conference in Dallas, Texas, April 22, 1963.
2. J. M. Dahlen and J. L. Nevins, "Navigation for the Apollo Program", MIT Instrumentation Laboratory Report, R-447, May 1964, given at the National Space Meeting of the Institute for Navigation, St. Petersburg, Florida, April 30, 1964.
3. N. Sears, "Technical Development Status of Apollo Guidance and Navigation", Paper 64-17, published in Advances in the Astronautical Sciences, pp. 114-450, Vol. 18, 1964.
4. Richard H. Battin, "A Statistical Optimizing Navigation Procedure for Space Flight", MIT Instrumentation Laboratory Report R-341, May 1962, published in the American Rocket Society Journal, November 1962.
5. Richard H. Battin, "Explicit and Unified Methods of Spacecraft Guidance Applied to a Lunar Mission", presented at the 15th International Astronautical Congress, Warsaw, 1964.
6. M. B. Trageser and D. G. Hoag, "Apollo Spacecraft Guidance System", MIT Instrumentation Laboratory Report R-495, June 1965, given at the IFAC Symposium on "Automatic Control in the Peaceful Uses of Space", Stavanger, Norway, 1965.

REFERENCES (con't)

7. Thomas J. Lawton and Charles A. Muntz, "Organization of Computation and Control in the Apollo Guidance Computer", MIT Instrumentation Laboratory Report E-1758, April 1965, given at the IFAC Symposium on "Automatic Control in the Peaceful Uses of Space", Stavanger, Norway, 1965.
8. R. L. Alonso, H. Blair-Smith, and A. L. Hopkins, "Some Aspects of the Logical Design of a Control Computer: A Case Study", Report EC12, No. 5, published in the IEEE Transactions on Electronic Computers, December 1963.
9. R. L. Alonso and A. L. Hopkins, "The Apollo Guidance Computer", MIT Instrumentation Laboratory Report R-416, August 1963, reprinted as Report 6.1, PTGSET Record, published by the Professional Technical Group on Space Electronics and Telemetry of the IEEE, 1963.
10. E. C. Hall, "Case History of the Apollo Guidance Computer", MIT Instrumentation Laboratory Report E-1970, June 1966, presented in Europe in June 1966 under the sponsorship of NATO's Advisory Group for Aerospace Research and Development.
11. R. L. Alonso, "AGC Keyboard and Display Formats", an internal MIT Instrumentation Laboratory Memorandum, Digital Development Memo No. 40, 26 September 1962.

MISSION PHASE SUMMARY

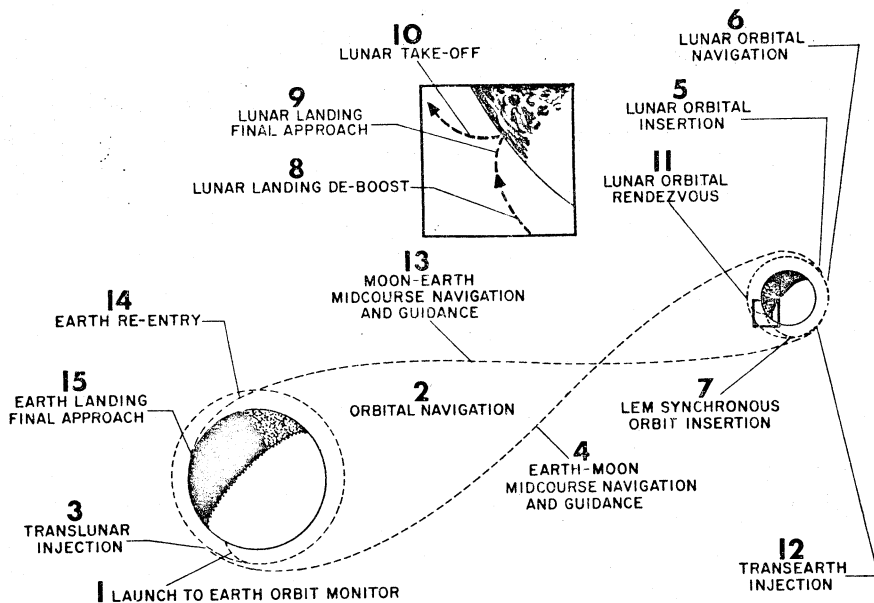

M.I.T. INSTRUMENTATION LABORATORY — TP#6613-17 — 11/62

Mission Phase Summary

A1

PROPULSION FAILURE ABORT PATHS

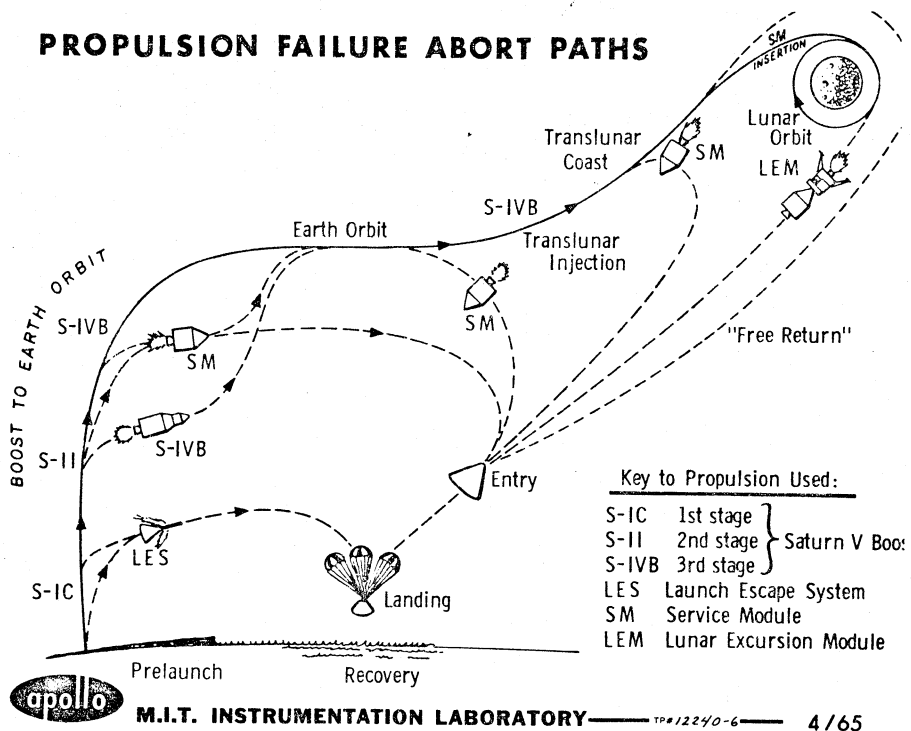

apollo M.I.T. INSTRUMENTATION LABORATORY TP-12240-6 4/65

Propulsion Failure Abort Paths

A 2

APOLLO GUIDANCE AND NAVIGATION - FUNCTION FLOW

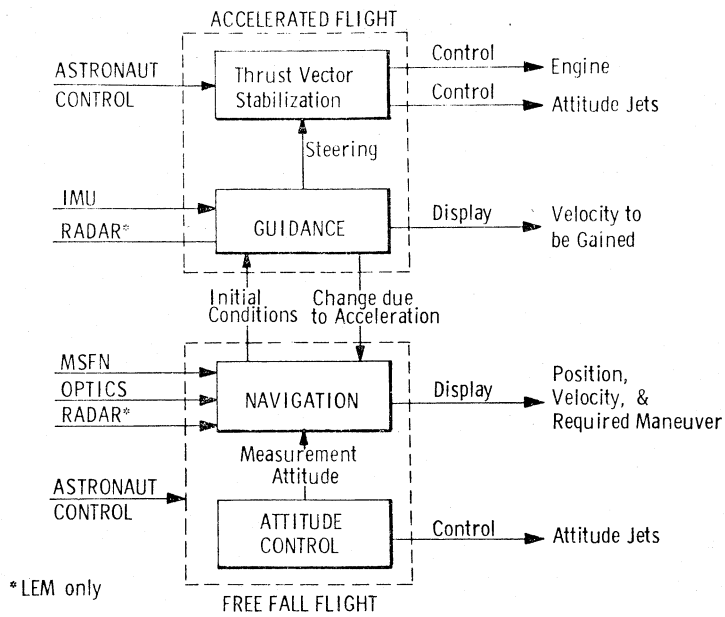

M.I.T. INSTRUMENTATION LABORATORY

TP-13365-24
REV. 5/65

3/65

G&N Function Flow

A3

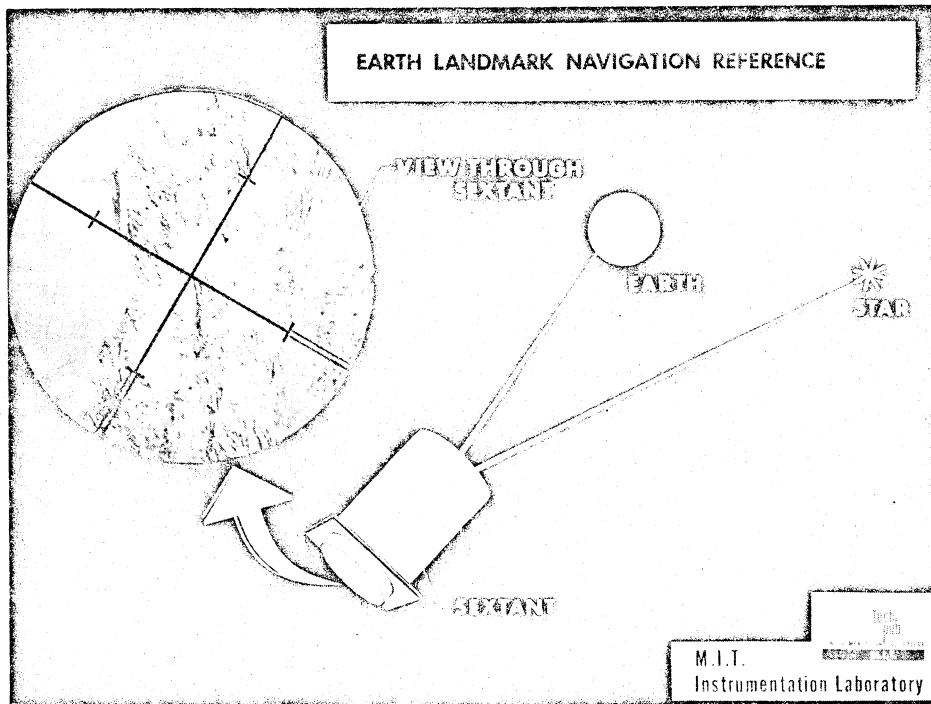

Earth Landmark Nav. Ref (Sighting)

A4

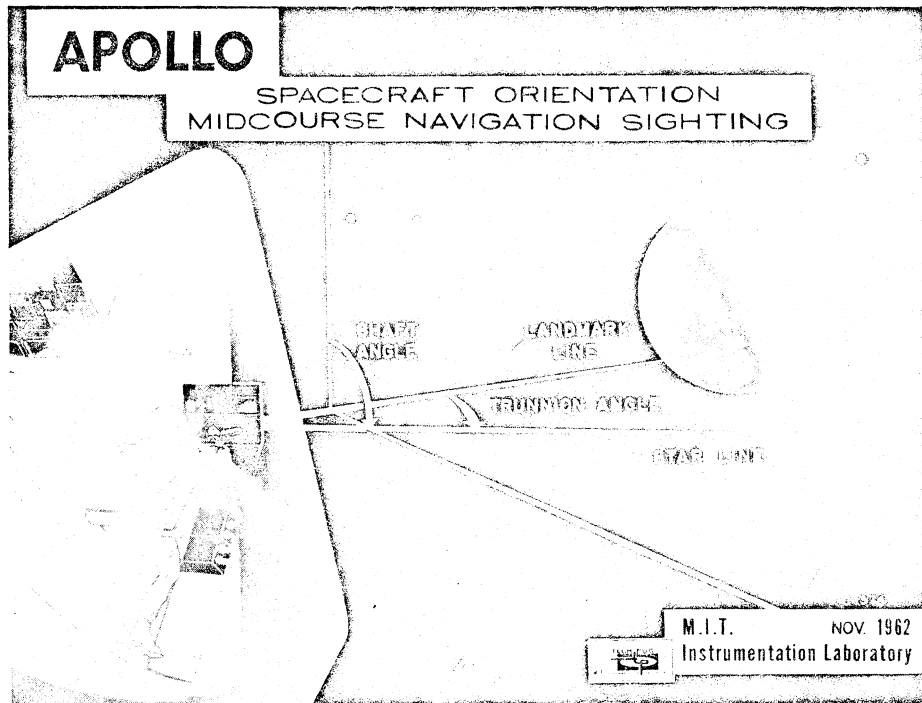

S/C Orientation, Midcourse Nav. Sighting

AS

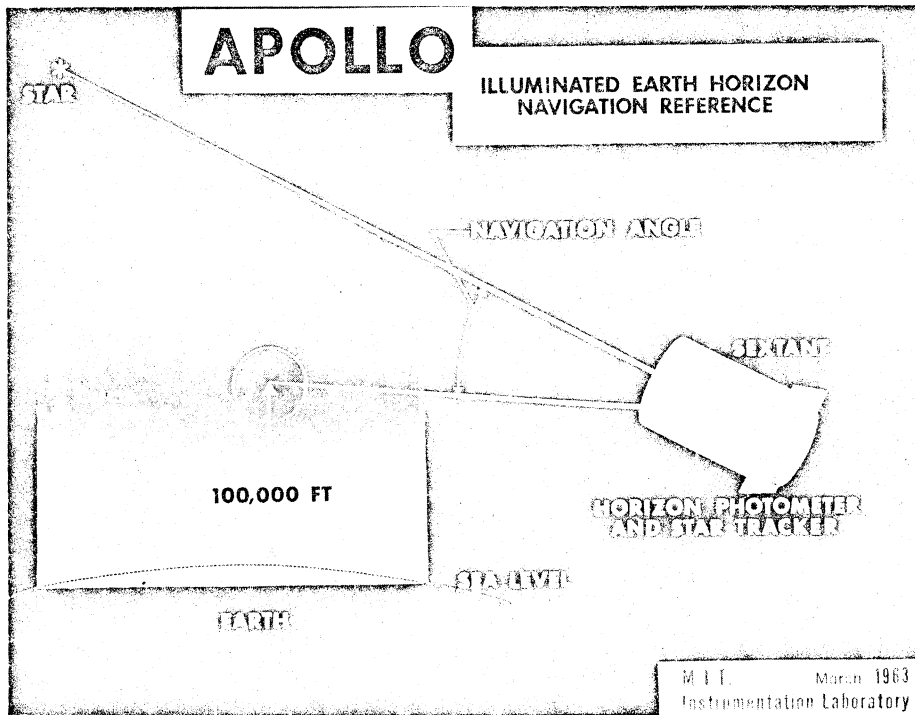

Illuminated E. Horiz. Nav. Ref.

AC

OPTICAL SCHEMATICS

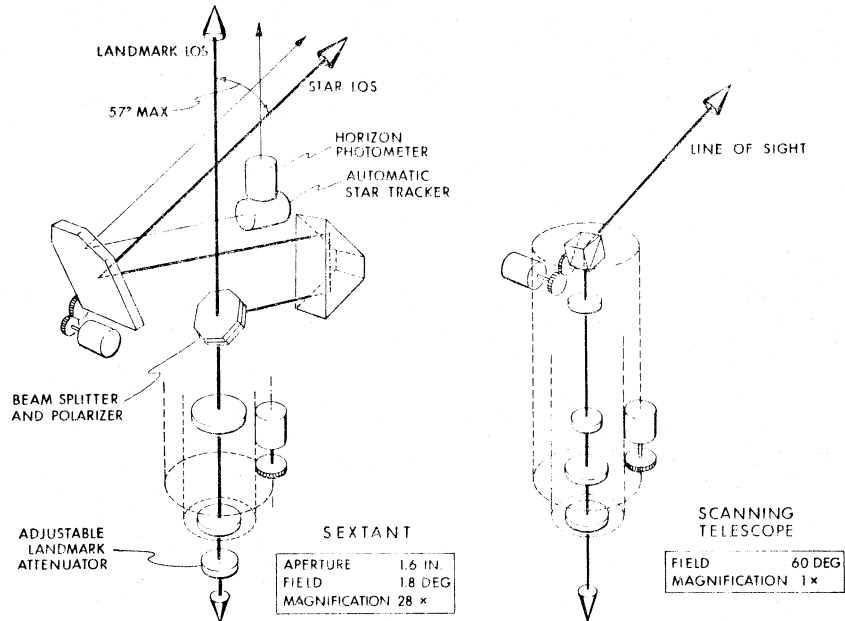

M.I.T. INSTRUMENTATION LABORATORY — TP#B490-13 — 3/64

Optical Schematics

A7

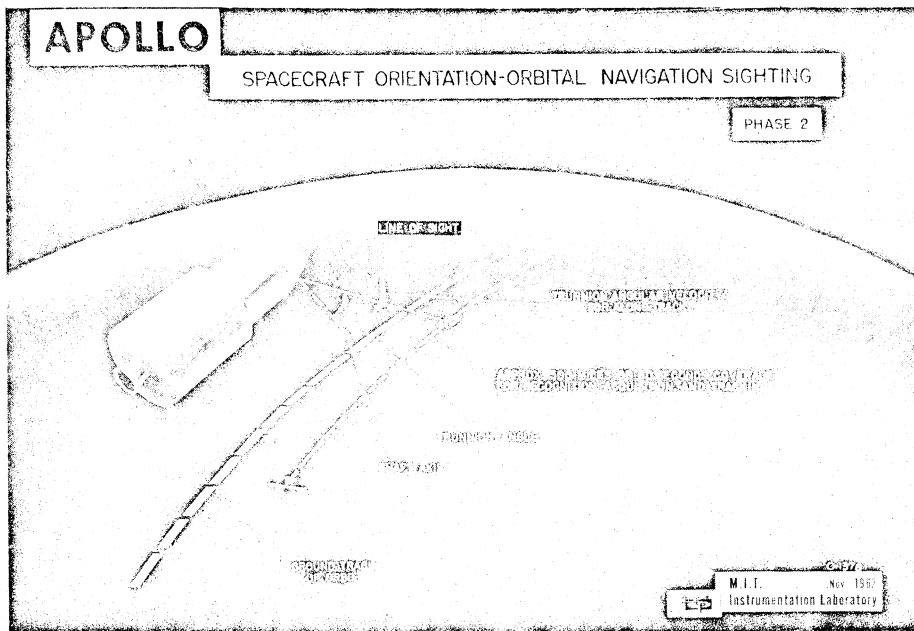

S/C Orientation - Orb. Nav. Sighting

A 9

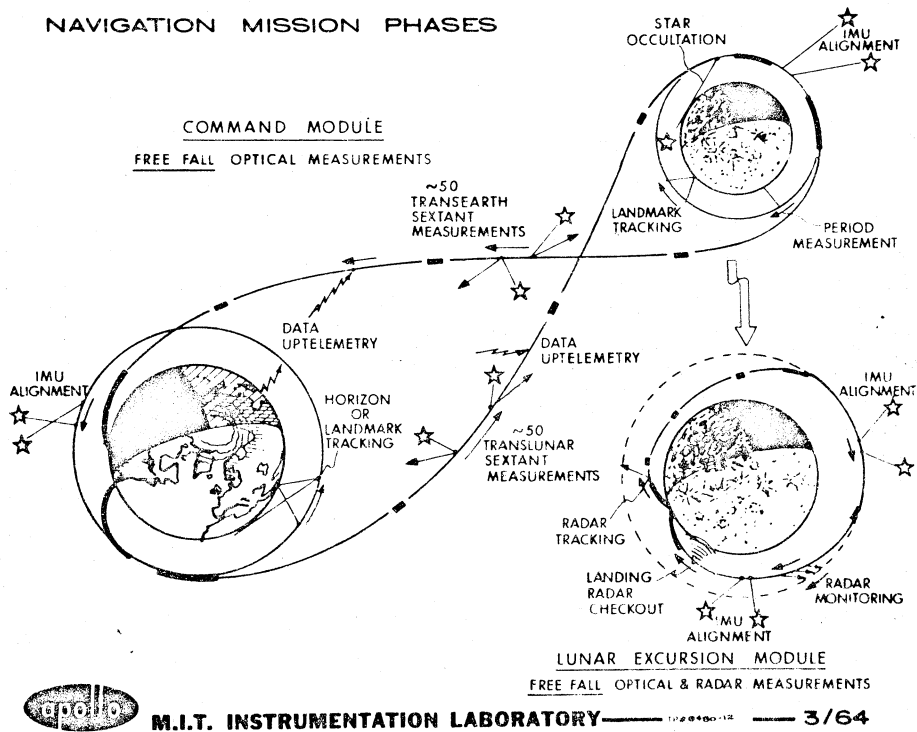

Navigation Guidance Mission Phases

A 9

GUIDANCE MISSION PHASES

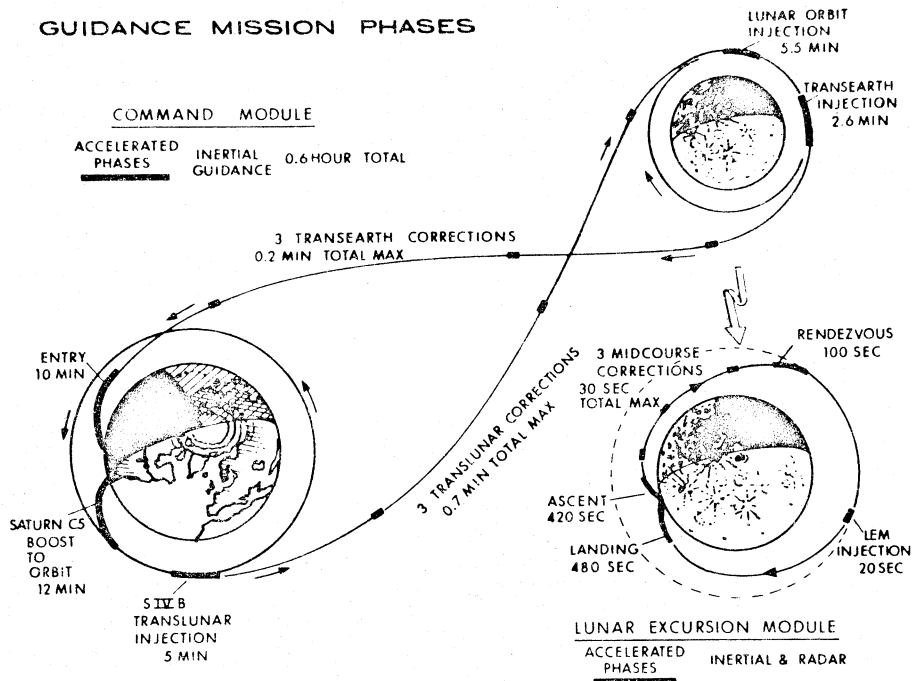

M.I.T. INSTRUMENTATION LABORATORY — 3/64

Guidance ~~Now~~ Mission Phases

A10

GN&C DIGITAL A/P BLOCK DIAGRAM

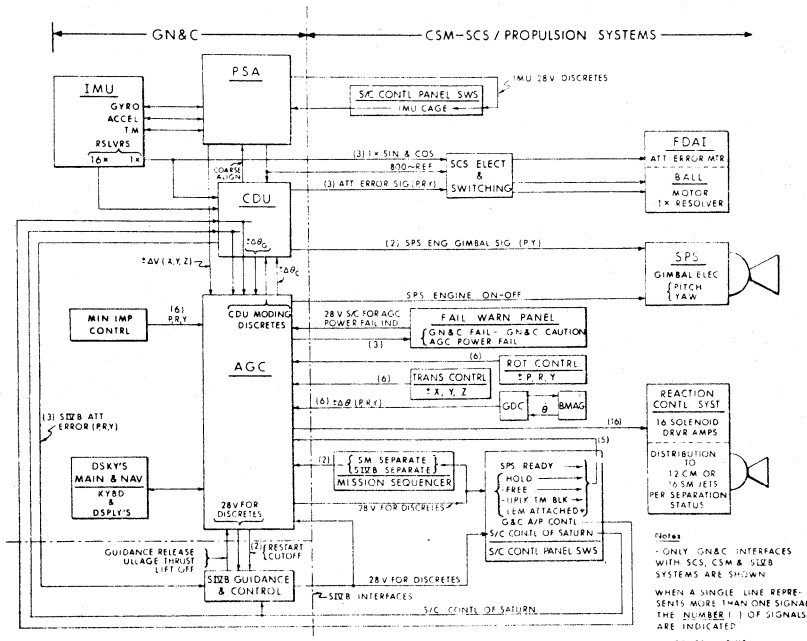

M.I.T. INSTRUMENTATION LABORATORY — 8/64

GN&C Digital A/P Block Diagram

A-10

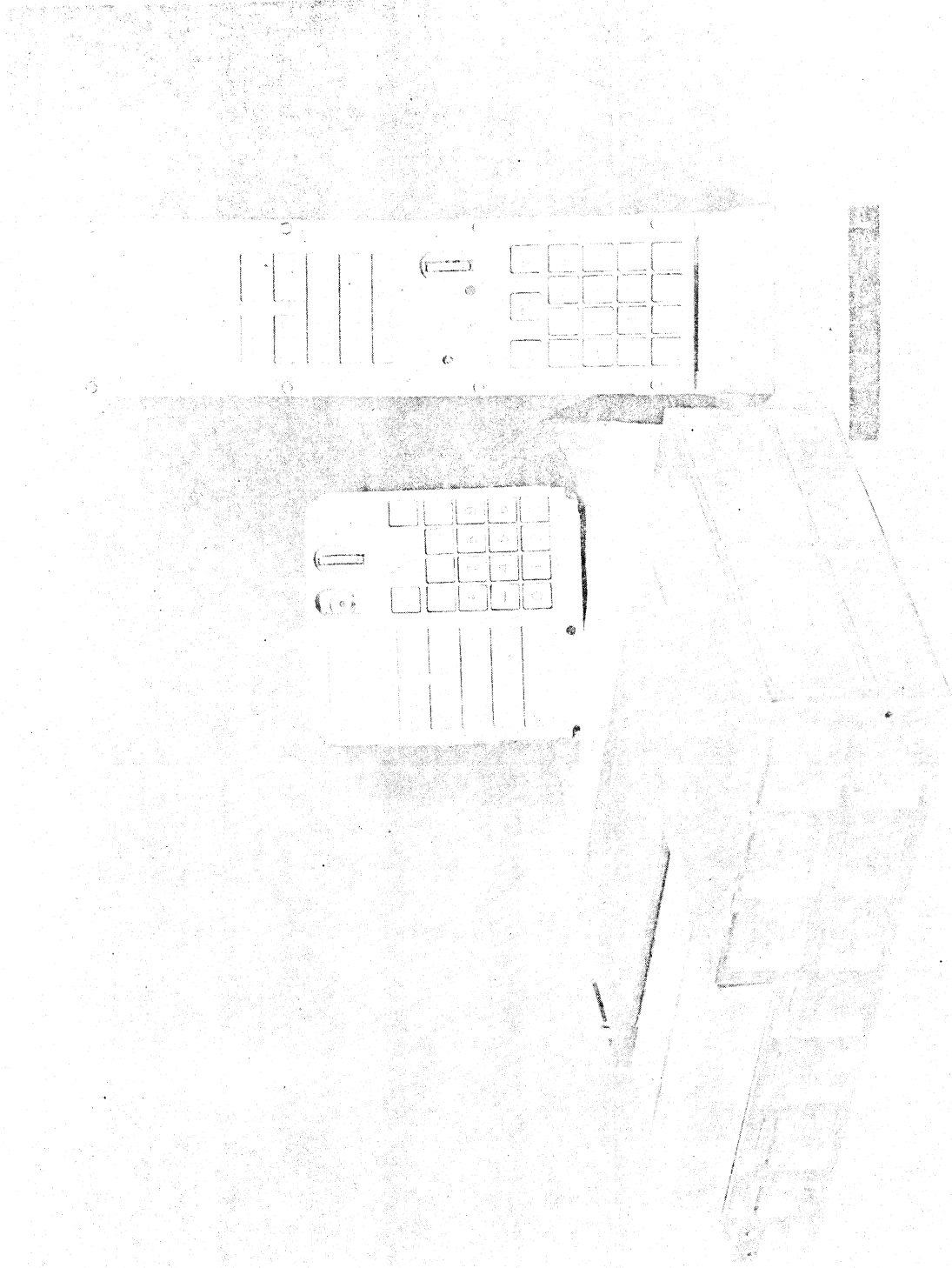

A/2

Fig. 1 Block I Computer and DSKYs

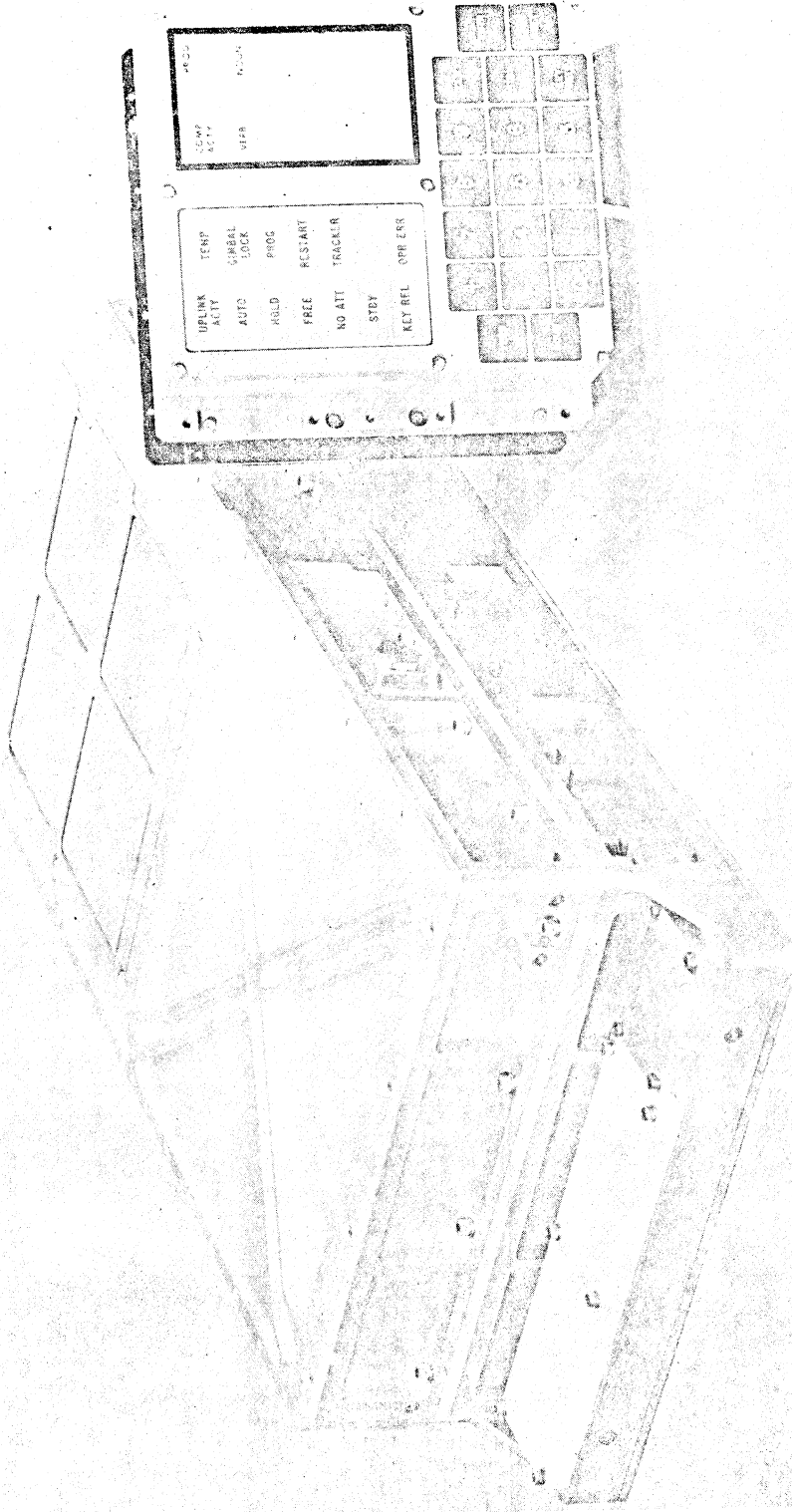

A 13

Fig. 4 Block II Computer and DSKYs

COMPUTER CHARACTERISTICS

Performance Characteristics	Block I	Block II
Word Length	15 Bits + Parity	15 Bits + Parity
Number System	One's Complement	One's Complement
Fixed Memory Registers	24,576 Words	36,864 Words
Erasable Memory Registers	1,024 Words	2,048 Words
Number of Normal Instructions	11	34
Number of Involuntary Instructions (Interrupt, Increment, etc.)	8	10
Number of Interrupt Options	5	10
Number of Counters	20	29
Number of Interface Circuits	143	227
Memory Cycle Time	11.7 μ sec	11.7 μ sec
Counter Increment Time	11.7 μ sec	11.7 μ sec
Addition Time	23.4 μ sec	23.4 μ sec
Multiplication Time	117 μ sec	46.8 μ sec
Double Precision Addition Time	Subroutine (1.65 millisecc)	35.1 μ sec
Number of Logic Gates (Microcircuits)	4,100	5,600 (2,800 packages)
Volume	1.21 cubic ft. (34,300 cc)	0.97 cubic ft. (27,400 cc)
Weight	87 pounds (39.4 Kg)	65 pounds (29.5 Kg)
Power Consumption	100 Watts	70 Watts

Fig A14

AGE SPACECRAFT LOCATION

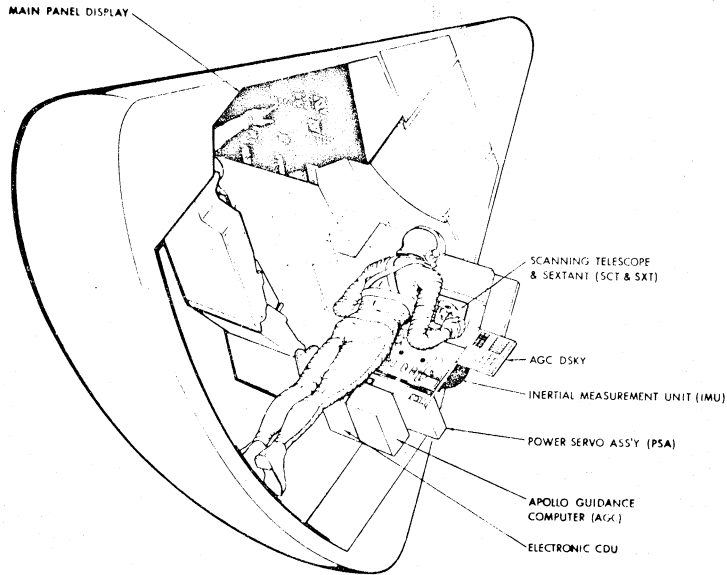

M.I.T. INSTRUMENTATION LABORATORY

TPR 7147-1
REV 5/65

5/65

AGE S/C Location - Block II

A 15

LEM PGNCs INSTALLATION

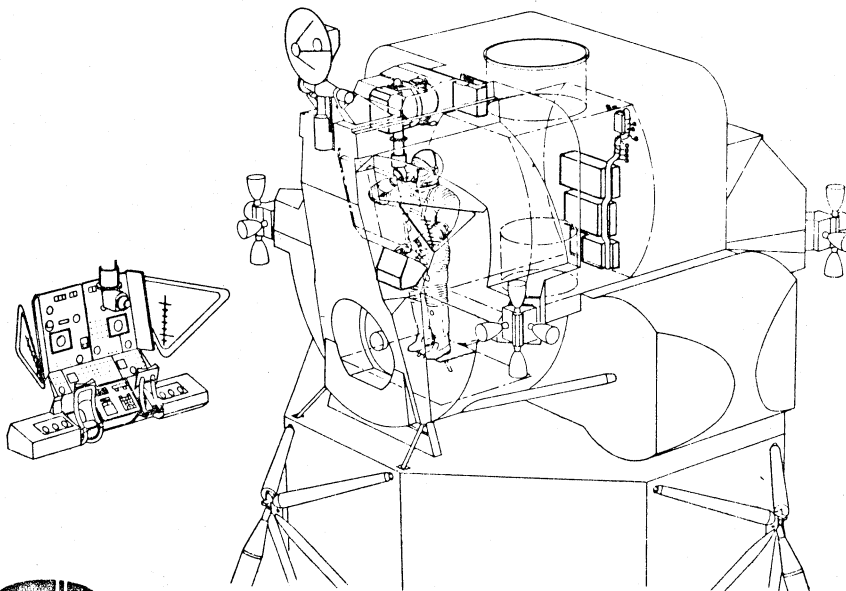

M.I.T. INSTRUMENTATION LABORATORY

TPR 7147-1
REV 5/65

LEM PGNCs Installation

AAC

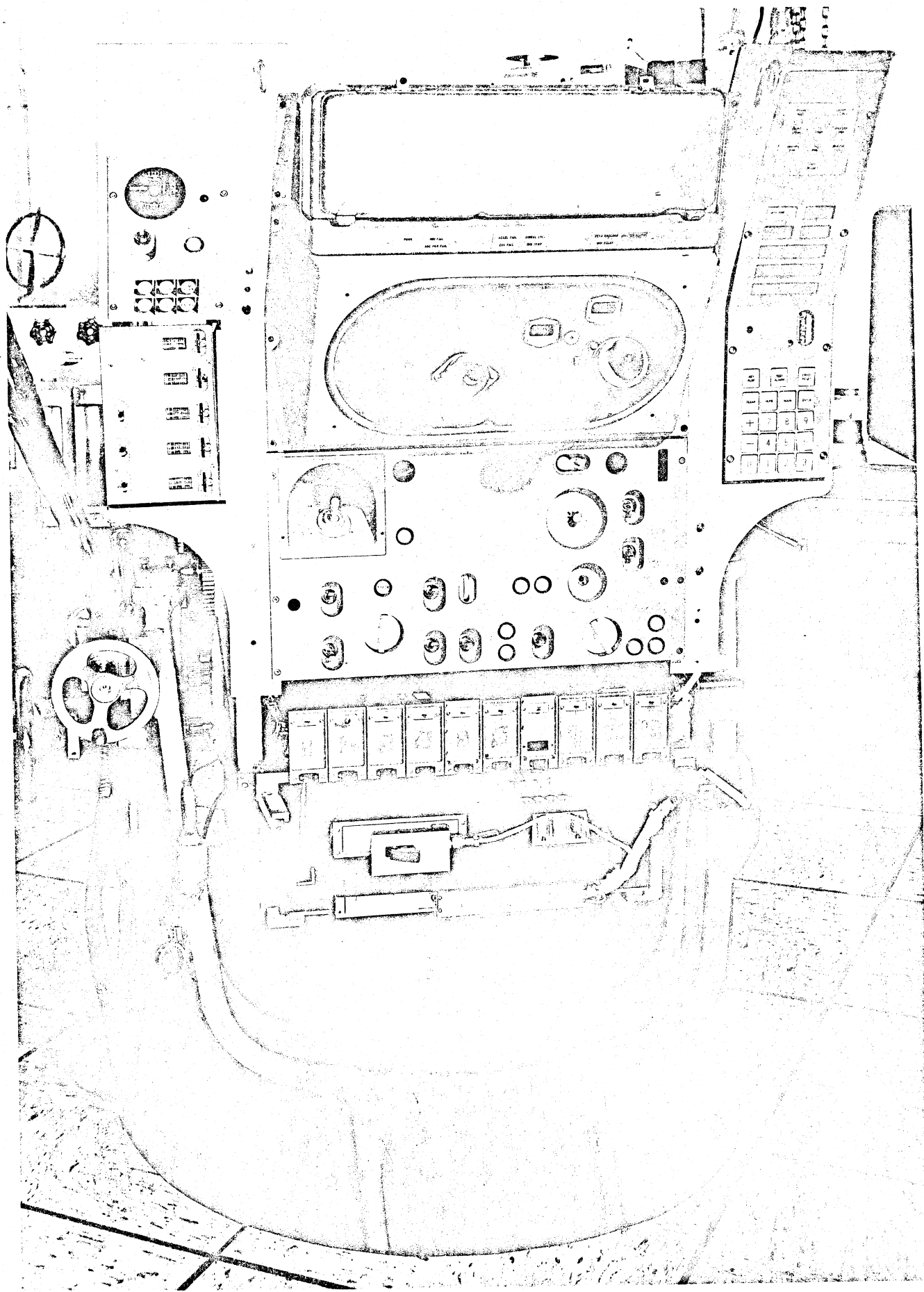

Fig A17

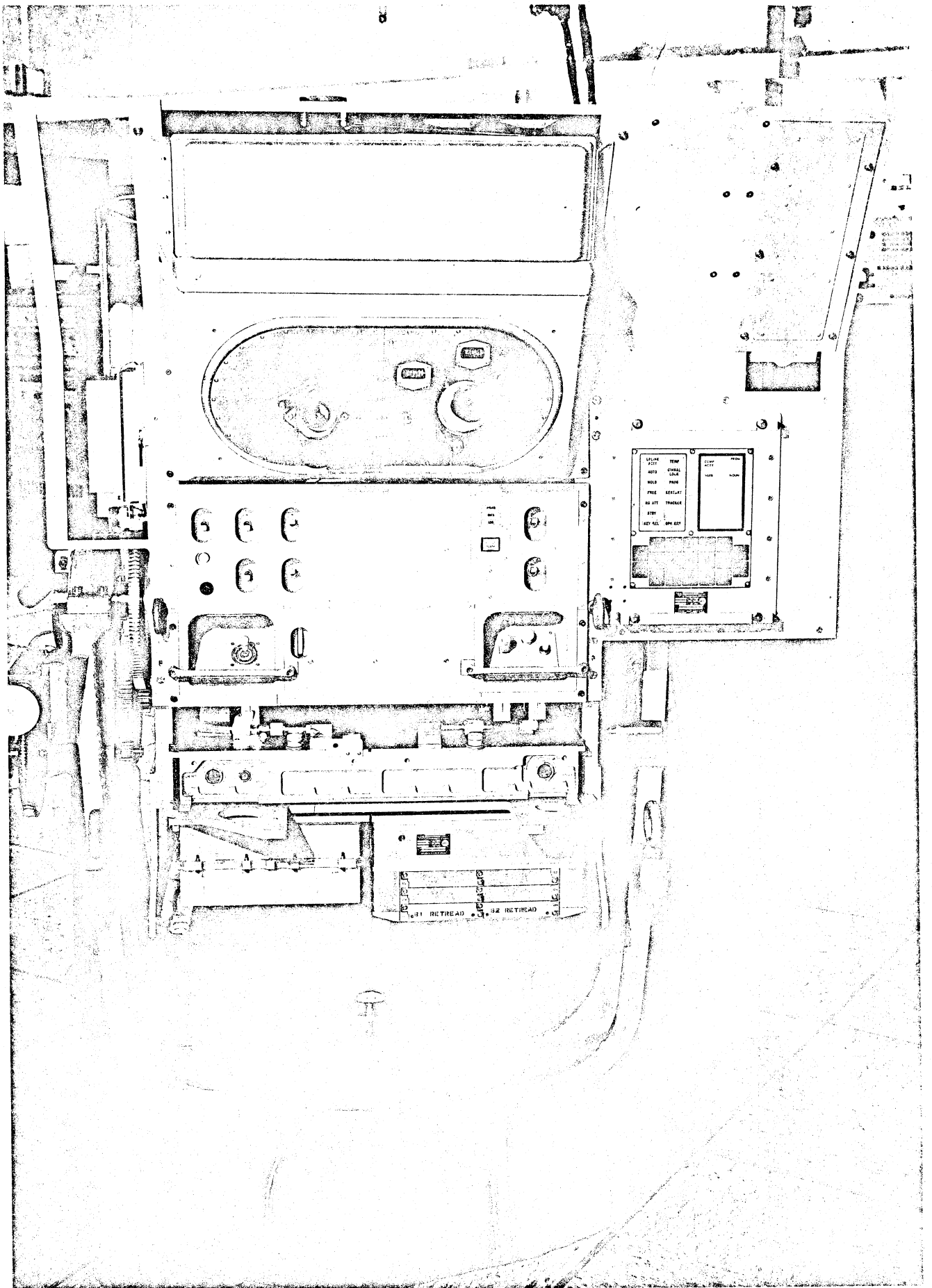
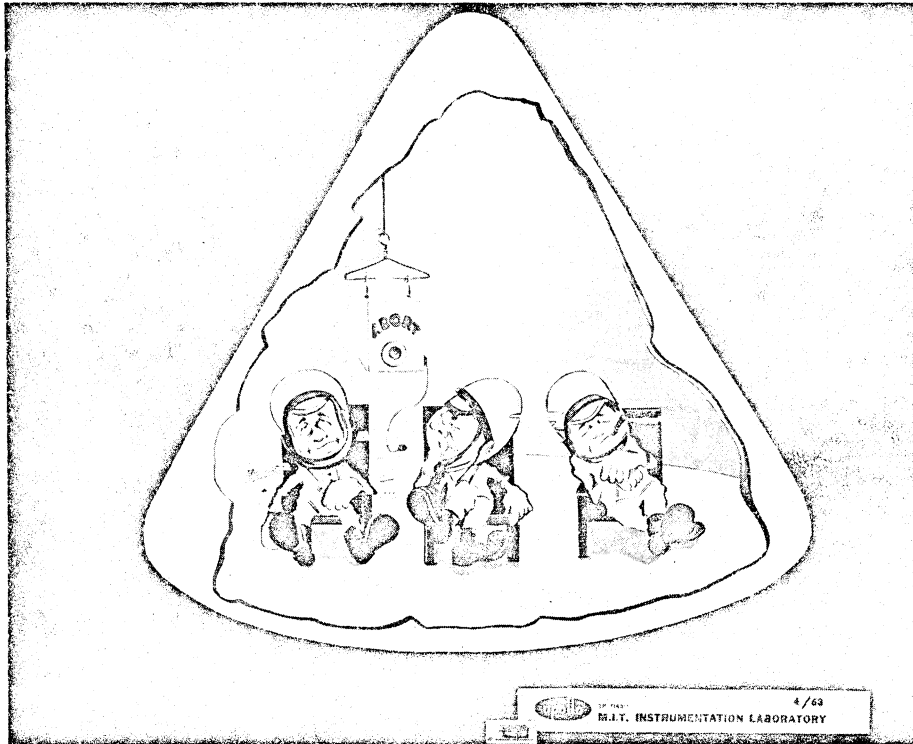
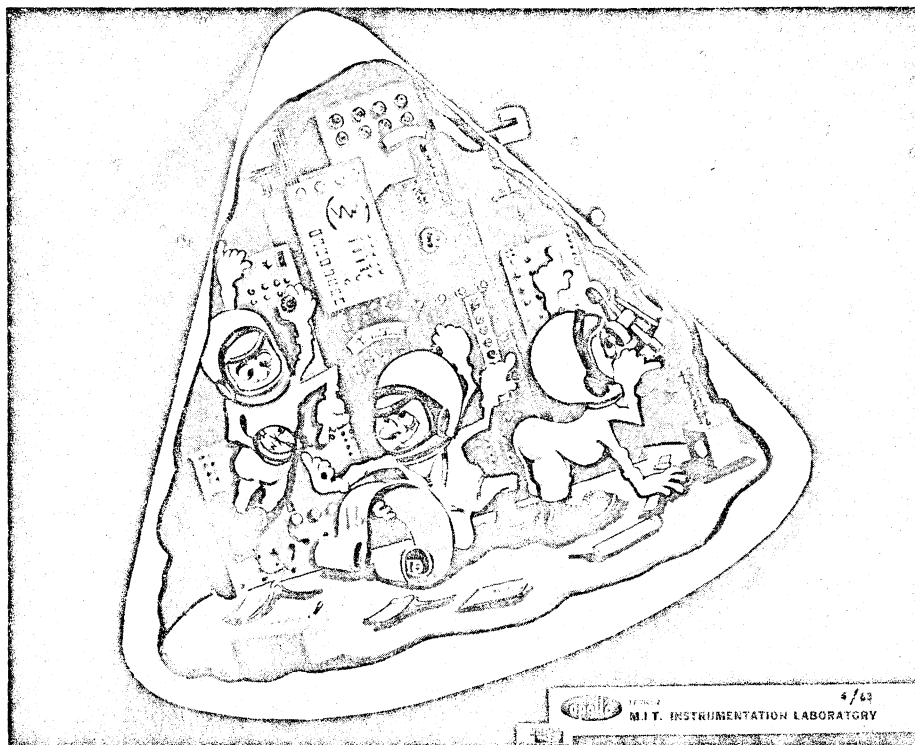

Fig A18



"Fully" Automatic System

□ A19



"Fully" Manual System

□ A20

MIDCOURSE NAVIGATION
 MANUAL STAR-LANDMARK ANGLE MEASUREMENT

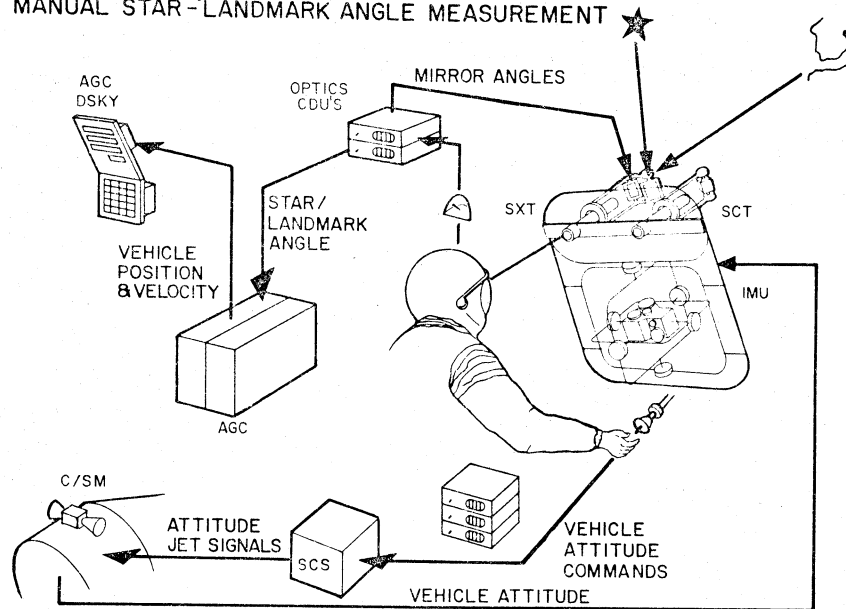

M.I.T. INSTRUMENTATION LABORATORY — 11-8180-8 — 3/64

Midcourse Nav., Manual Star-Landmark
 Angle Measurement

A21

Mission Phase	Prog. No.	Mission 204 CM (Block I)	Mission Phase	Prog. No.	Mission Phase	Prog. No.	
Mission Phase	00	AGC Idling	Coast-cont'd	24	Ground Track Determination	52	SIVB/IMU Align
	01	Pre-Launch Initialization		25	-----	53	CSM/IMU Align
	02	Gyrocompassing		26	-----	54	IMU Realign
	03	Optical Verification of Azimuth		27	AGC Update	55	-----
	04	Inertial Reference		30	-----	56	-----
	05	G&N Startup		31	Orbit Change	57	-----
	06	G&N Power Down		32	Return to Earth	60	-----
Service	07	System Test (non-flight)	Pre-thrusting	33	SPS Minimum Impulse	61	Maneuver to CM/SM Sep. Attitude
	10	-----		34	-----	62	CM/SM Sep. & Pre-Entry Maneuver
	11	Pre-LET Jettison		35	-----	63	Entry Initialization
	12	Post-LET Jettison		36	-----	64	Post 0.05 G
	13	-----		37	-----	65	Up Control
	14	-----		40	-----	66	Ballistic
	15	-----		41	Orbit Change	67	Final Phase
Boost	16	-----	Thrusting	42	Return to Earth	70	-----
	17	LET Abort		43	Minimum Impulse	71	1st Abort Burn Monitor
	20	-----		44	-----	72	-----
	21	-----		45	-----	73	-----
	22	Landmark Tracking Nav. Measurement		46	-----	74	-----
	23	Star/Landmark on Horizon Nav. Measurement		47	-----	75	-----
	23	Star/Landmark on Horizon Nav. Measurement		50	-----	76	-----
Coast	23	Star/Landmark on Horizon Nav. Measurement	Alignment	51	IMU Orientation Determination	77	-----

Fig 01

Mission 204
CSM (Block I)

Routine
Number

1 Attitude Control Mode Check
2 Thrust Control Mode Check
3 Entry Control Mode Check
4 Fine Alignment
5
6
7
8
9
10
11
12
13
14
15
16
17
18
19
20
21 Attitude Maneuver
22 SCS Discrete Monitor
23
24 Delta V Monitor
25 Coarse Alignment
26
27 Sighting Mark
28 Auto Optics Positioning
29 Star Data Test
30 Gyro Torqueing
31 Back Delta V Counter Display
32
33 Pre-Th.Min. Imp. Data Load
34 Orbit Parameter Display
35 Pre-Th.Orbit Chng. Data Load
36 Pre-Th.Ret. to Earth Data Load
37 SPS Engine Ignition
38 SPS Engine Thrust Fail

Fig B1

VERB LIST

01 Disp Oct Compnt 1 (R1)
 02 Disp Oct Compnt 2 (R1)
 03 Disp Oct Compnt 3 (R1)
 04 Disp Oct Compnt 1, 2 (R1,R2)
 05 Disp Oct Compnt 1, 2, 3
 06 Disp Decimal
 07 DP Decimal Disp (R1,R2)
 10 Request Waitlist
 11 Monitor Octal Compnt 1 (R1)
 12 Monitor Octal Compnt 2 (R1)
 13 Monitor Octal Compnt 3 (R1)
 14 Monitor Octal Compnt 1, 2 (R1,R2)
 15 Monitor Octal Compnt. 1, 2, 3
 16 Monitor Decimal
 17 Monitor DP Decimal (R1,R2)
 20 Request Executive
 21 Load Compnt 1 (R1)
 22 Load Compnt 2 (R2)
 23 Load Compnt 3 (R3)
 24 Load Compnt 1, 2
 25 Load Compnt 1, 2, 3
 26 Spare
 27 Spare
 30 Spare
 31 Bank Disp
 32 Spare
 33 Pro W/O Data
 34 Terminate Prog
 35 Release Disp System
 36 Fresh Start
 37 Change Prog
 40 Zero (ICDU)
 41 Coarse Align (ICDU or OCDU)
 42 Fine Align IMU
 43 Manual CDU
 44 Att Control
 45 Entry
 46 Coarse Align
 50 Please Perform
 51 Please Mark
 52 Reject Mark
 53 Free (ICDU or OCDU)
 54 Pulse Torque Gyros

55 Align Time
 56 Perform Banksum
 57 System Test
 60 Prepare for Standby
 61 Recover from Standby
 62 Illegal Verb
 63 Illegal Verb
 64 Disp Orbl Parmts
 65 Calc T of Arr at Long
 66 Calc Lat Long at Spec T
 67 Calc Max Dec, T of Arr
 70 Man Att Maneuver
 71 MTVC Takeover
 72 Min Imp Aim Pt Update
 73 Ret-Earth Aim Pt Update
 74 Orb Chge Aim Pt Update
 75 Perform Backup Liftoff
 76 R, V, T Update (State Vec)
 77 Liftoff Time Update

Fig B2

NOUN LIST

00 Not in use
 01 Specify machine address (fract).XXXXX
 02 Specify machine address (whole)XXXXX.
 03 Spare
 04 Spare
 05 Angular error
 06 Spare
 07 Change of program (perform)
 10 Spare
 11 Thrust on enable (perform)
 12 Gimbal angles
 13 Delta V measured
 14 Delta V counter setting
 15 Increment machine address
 16 AGC clock time
 17 Final ICDU angles Roll
 Pitch
 Yaw
 20 Present ICDU angles Roll
 Pitch
 Yaw
 21 PIPA pulses
 X
 Y
 Z
 22 New angles ICDU
 Roll
 Pitch
 Yaw
 23 Delta angles ICDU
 Roll
 Pitch
 Yaw
 24 Delta Time for AGC clock
 25 Checklist (please perform)
 26 Prio/delay
 27 Self test on/off SW
 30 Star number

31 Failure info Fail reg
 Sfail
 Ercount
 32 Spare
 33 Time of ignition
 34 Event time
 35 Delta event time
 36 Delta event time
 37 Sighting identification
 40 Gamma
 Inertial velocity (VI)
 Altitude above launch pad (HPAD)
 Max acceleration (Gmax),
 Perigee altitude (HP)
 Free-fall time (TFF)
 Miss distance (Delta R)
 Perigee altitude (HP)
 Free-fall time (TFF)
 Apogee altitude (HA),
 Perigee altitude (HP),
 Free-fall time (TFF)
 Latitude,
 Longitude,
 Altitude
 Apogee altitude (HA)
 Perigee altitude (HP)
 Delta V required
 Time to event,
 Velocity to be gained (VG),
 Perigee altitude (HP)
 Gamma at 300K
 Miss distance (Delta R),
 Inertial velocity (VI at 300K)
 Time to event, (IG)
 Delta time burn
 Delta V measured
 Time to event (IG or ECO)
 Velocity to be gained (VG),
 Measured velocity change

Fig 13a

52 Time to event (ECO) XXBXX MIN/SEC
 Velocity to be gained (VG) XXXXX, FT/SEC
 Free-fall time (TFF) XXBXX MIN/SEC
 53 Max acceleration (Gmax), XXX.XX G
 Gamma (300K) XXX.XX DEG
 Free-fall time (TFF) XXBXX MIN/SEC
 54 Command roll angle (Beta) XXX.XX DEG
 Present acceleration (G) XXX.XX G
 Range to targ (Shaft), XXXX.X NAUT MI
 OCDU (Shaft), XXX.XX DEG
 55 (Trunnion) XX.XXX DEG
 56 .Mark data (Shaft), XXX.XX DEG
 (Trunnion) XX.XXX DEG
 57 New angles OCDU (Shaft) XXX.XX DEG
 (Trunnion) XX.XXX DEG
 60 IMU mode status In3 OCTAL
 Waskset OCTAL
 Olderr OCTAL
 61 Target Azimuth XXX.XX DEG
 Elevation XX,XXX DEG
 62 Impact latitude, XXX.XX DEG
 Impact longitude, XXX.XX DEG
 Heads up/down +00001/-00001
 63 Latitude, XX.XXX DEG
 Longitude/2, XX.XXX DEG
 Altitude XXX.XX NAUT MI
 64 Present lat XXX.XX DEG
 Present long XXX.XX DEG
 Present alt XXXX.X NAUT MI
 65 Sampled AGC clock time 00XXX. HRS
 000XX. MIN
 0XX.XX SEC
 XXXXX.
 .XXXXX
 XXXXX.
 66 System test results XX.XXX DEG
 XX.XXX DEG
 XX.XXX DEG
 XXX.XX DEG
 XXX.XX DEG
 XXX.XX DEG
 67 Delta gyro angles X
 Y
 Z
 70 Pitch trim, XXX.XX DEG
 Yaw trim XXX.XX DEG
 Delta time tail-off XXX.XX DEG

71 Command roll angle (Beta), XXX.XX DEG
 Present acceleration (G), XXX.XX G
 Predicted range-range to targ XXXX.X NAUT MI
 72. Delta position X XXXX.X KILO
 Y XXXX.X KILO
 Z XXXX.X KILO
 73 Delta velocity X XXXX.X M/SEC
 Y XXXX.X M/SEC
 Z XXXX.X M/SEC
 74 Delta velocity allowable, XXXXX. FT/SEC
 Delta time tail-off XXX.XX SEC
 75 Delta position magnitude, XXXX.X NAUT MI
 Delta velocity magnitude XXXXX. FT/SEC
 Multiple mark counter 00XXX.
 76 Spare
 77 Spare

Fig 02

CHECKLIST CODES

00001 SCS - G&N Attitude
00002 SCS - G&N Delta V
00003 SCS - G&N Entry
00004 SCS - SCS Attitude
00007 Att Trim Maneuv Enable
00011 Auto Optics Pos
00013 Optics Mode - Computer
00014 Fine Align Check
00015 Perform Star Acq
00016 Terminate Mark Sequence
00041 CM/SM Sep
00051 Final IMU/Final Vehicle
00052 Interim IMU/Final Vehicle
00053 Final IMU/Interim Vehicle
00054 Interim IMU/Interim Vehicle
00060 IMU Turn On
00061 IMU Power Down
00062 AGC Power Down

Fig 02

AS 204 - Ground Track Determination
 Program 24

Step No.	Group	Data	DSKY Display	Response	Remarks
1	Results of Computation Program Call	{ HA, HP, TFF T to Perigee	V64		
2			F V16 N43	V33	
3			F V16 N45	V33	
or			P00		
1	Request		V65		
2	Results of Computation	{ Load-T Per- missible Load-Longi- tude T Long Lat, Long, Alt	F V21 N34	V33	
3			F V22 N44	V33	
4			F V06 N34	V33	
5	Program Call		P00		
or			V66		
1	Request Results of Computation Program Call	{ Load-T Lat, Long, Alt	F V21 N34	V33 or V34	
2			F V06 N44	V33 or V34	
3			P00		
or					
1	Request		F V21 N34		
2	Results of Computation Program Call	{ Load-T Per- missible T Max Dec Lat, Long, Alt	F V06 N34	V33	
3			F V06 N44	V33	
4			P00		

Fig B3

AS 204 - SIVB/IMU Align

Program 52

Step No.	Group	Data	DSKY Display	Response	Remarks
1	Initialize Controls				Set Controls to Nominal; Except: B+D ROLL, PITCH, YAW, RATE GYRO POWER, BMAG POWER, ROT. CONT. PWR-OFF OPTICS MNA+MNB-CLOSED
2	Program Selection		V37,52	Check FINE ALIGN MODE LT-On	
3	Check				Check COARSE ALIGN MODE LT-On (45s) FINE ALIGN MODE LT-On (20s)
4	Data Load	Star Code	F V06 N30	V33 or V21	
5	Request	OSS SW TO CMC	PF V50 N25 00013	OPTICS MODE SW-COMPUTER E or V33 (Position optics manually)	
6					Identify Target in SCT
7	Request	Please Mark	F V51	MARK	
8		Terminate Marks	F V50 N25 00016	E or V52	
9	Data	Star Code	F V21 N30	+000XX E	
10	Load	Star Code	F V06 N30 PF V50 N25 00013	V33 or V21 OPTICS MODE SW-COMPUTER E or V33	

Fig B4

AS 204
 Program 52 (cont'd)

Step No.	Group	Data	DSKY Display	Response	Remarks
11	Request	Please Mark	F V51	MARK	
12		Terminate Marks	F V50 N25 00016	E and V52	
13	Data Load	Star Code	F V21 N30	+000XX E	
14 or 15	Results of Computations	Star Diff. Angle Star Diff. Angle	V06 N05 (105) F V06 N05	V33 or V37,00	Angle < .05° Angle > .05°
16 or 17		Δ Gyro Angles	F V06 N67	V33	Angles < 5°
		Δ Gyro Angles	V06 N67	V33 or V34	Any Angle > 5°
18	Request	Fine Align Check	F V50 N25 00014	E(Return step 4) or V33	
19	Program Call		P00		
20					OPTICS MNA+MNB--Open

Fig 134

AS 204 - Pre Thrusting Orbit Change

Program 31

Step No.	Group	Data	DSKY Display	Response	Remarks
1	Program Selection		V37, 31		
2	Data	GET I	F V06 N00	V33 or V25	
3	Load	Lat, Long, Alt	F V06 N44	V33 or V25	Aim Point Data.
4		Period	F V06 N34	V33 or V25	
5		P Trim, Y Trim	F V06 N70	V33 or V25	
6		ΔT Tailoff	F V06 N45	V33 or V37,00	
7	Results of	H _A , H _p ΔV Reg.	F V16 N35	V33	Set Clocks
8	Computation	TTI	F V06 N17	V33 or V37, 53	Gimbal Angles at Thrust
9	Request	Roll, Pitch Yaw	F V50 N25 00001	AME SW-ATTITUDE E or V33 (Bypass)	
10	Results of Computation	Roll, Pitch Yaw	F V16 N20	Align AGCU V33	Present ICDU Angles
11		Roll, Pitch, Yaw	F V06 N17	Set ATT SET dials. V33 or V70 (Manual Maneuver) or THC-CW and V33 (Manual Maneuver)	Final ICDU Angles
12	Program Call	Program Request	F V50 N07 00041	V37, 41	

Fig B5

AS 204
 Program 41 (cont'd)

Step No.	Group	Data	DSKY Display	Response	Remarks
8	Results of Computation	TTI, VG AVM	V06 N51		Report TTI = 2 MIN THRUST SW-NORMAL INJECT PREVALVES A+B-ON PRIM. THC-ARMED
9					
10					Check VM for PIPA bias.
11					Start Ullage
12	Request	Thrust On Enable	F V50 N11	E	
13					
14	Results of Computation	TG, VG, ΔVM	V06 N51		
15					Monitor Engine Cutoff
16	Results of Computation	TG, VG, ΔVM	F V16 N51	V33	
17					
18	Results of Computation	{ H _A , H _p , TFF T to Perigee	F V16 N43	V33	
19	Computation		F V16 N35	V33	
20	Program Call		F V50 N25 00000	V37,00	Set Controls after Tailoff

Fig B4

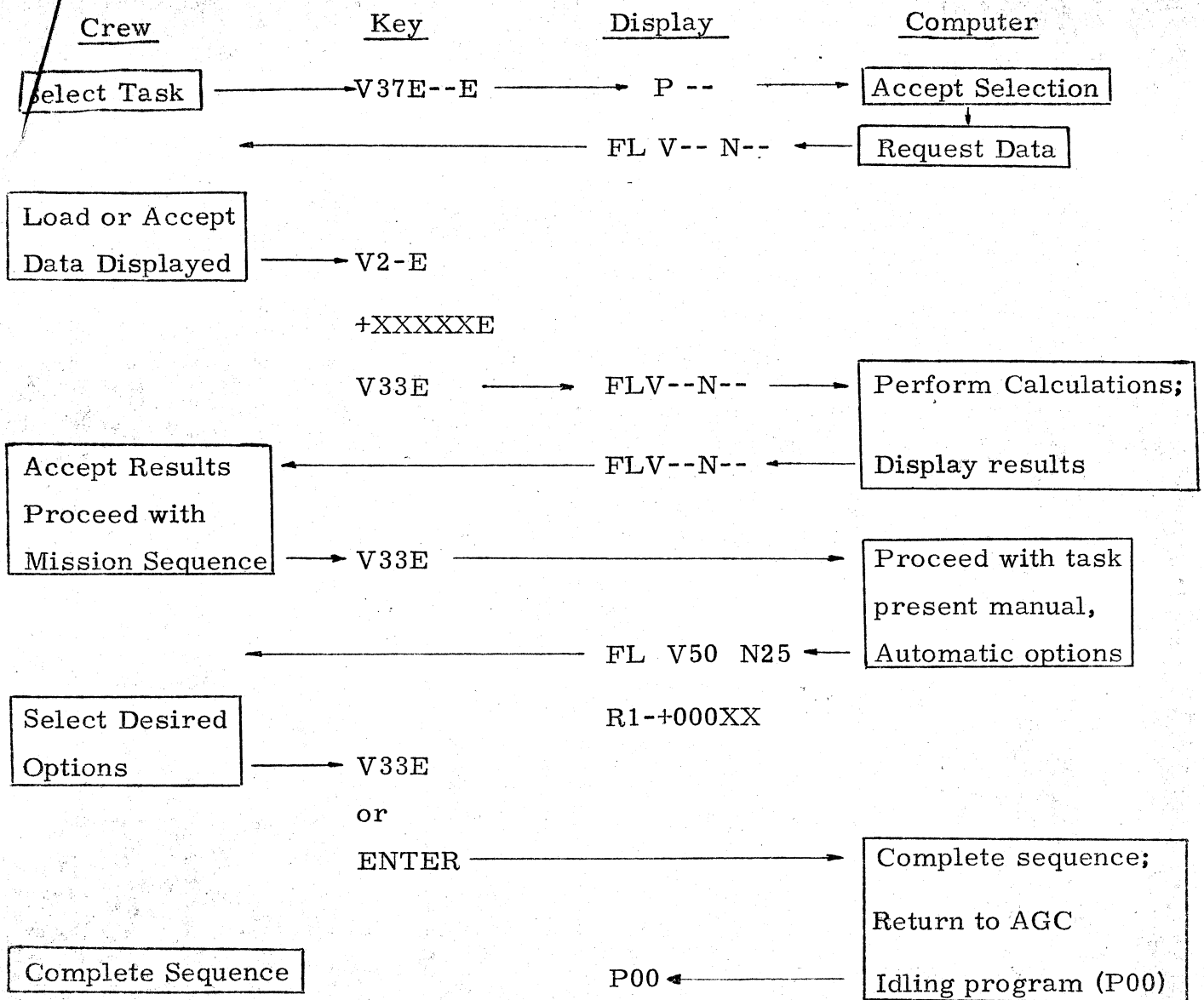

Figure B7