

FOR LIBRARY USE ONLY

Do Not Discard

R-539

A MANUALLY RETARGETED
AUTOMATIC DESCENT AND LANDING SYSTEM
FOR LEM

By: Allan R. Klumpp
Staff Member
Instrumentation Laboratory
Massachusetts Institute of Technology
10 March 1966

30 March 1966

Approved and cleared for public
dissemination as amended by
MSC, Houston on pages 3 and 18.
Confirmation ltr to follow.

JUR.

R-539

A MANUALLY RETARGETED
AUTOMATIC DESCENT AND LANDING SYSTEM
FOR LEM

ABSTRACT

During the final few minutes and several miles of the Apollo lunar landing, the Commander of the Lunar Excursion Module (LEM) is provided a manual steering capability. During this phase, called the approach phase, the LEM attitude is controlled such that the current landing site is continuously visible, and the guidance system is conditioned to accept incremental steering commands. The Commander identifies the current landing site by means of a computer display and a fixed reticle on the window. He steers by repetitively manipulating a hand controller. The guidance system responds to these controller commands by retargeting the guidance equations to a new landing site displaced by an angular increment, as seen by the Commander, from the old landing site. By this mechanism the LEM Commander can steer to any landing site he may select, specifically by steering the current site into coincidence with the selected site.

This paper describes the manual steering problem, the processes necessary to implement steering, derives the guidance equations, and presents all the equations essential to responding to steering commands, retargeting the guidance equations, and deriving attitude and throttle commands. Finally a trajectory representative of the class which may be used for the lunar landing is presented.

by A.R. Klumpp
10 March 1966

1. Introduction

During the final two or three minutes and the final few miles of his approach to the moon (Fig. 1) the Commander of the Lunar Excursion Modules (LEM) must visually survey the area which he approaches, choose a landing site within this area, and steer the LEM to that landing site. This paper describes the system proposed for the approach phase of the Apollo lunar landing.

Prior to the approach phase there is a completely automatic braking phase which takes the LEM from lunar orbit to those target conditions which properly set up the approach phase. After the approach phase there is a transition to hover and a vertical descent to touchdown. The braking phase and the transition to hover use the same guidance equations as the approach phase. The hover and vertical descent use a simple velocity-error-nulling technique. In this paper attention is focused primarily on the approach phase, the only phase in which the essential features described here are available.

The essence of the approach phase guidance system is the LEM Commander can manually steer the LEM to the selected landing site; yet the trajectory he flies is produced by an automatic guidance system. This hybrid combination allows very nearly continuous manual steering in the form of commands which incrementally shift the point on the surface at which the LEM will land, yet the automatic system provides very nearly the most efficient trajectory to the selected landing site consistent with certain constraints enumerated below.

Aside from the obvious desire of any man to control his craft, and aside from the general flexibility this capability provides, the system fulfills the following specific objectives.

1. During the approach, the LEM Commander must visually assess the safety of the trajectory. He must be assured impact is not imminent either because of equipment failure, which could result in a dangerous relationship between altitude and altitude rate, or because of some gross terrain obstruction along his course to the landing site. Although, by prediction, it will be very difficult to judge altitude, it should not be difficult to judge the relation-

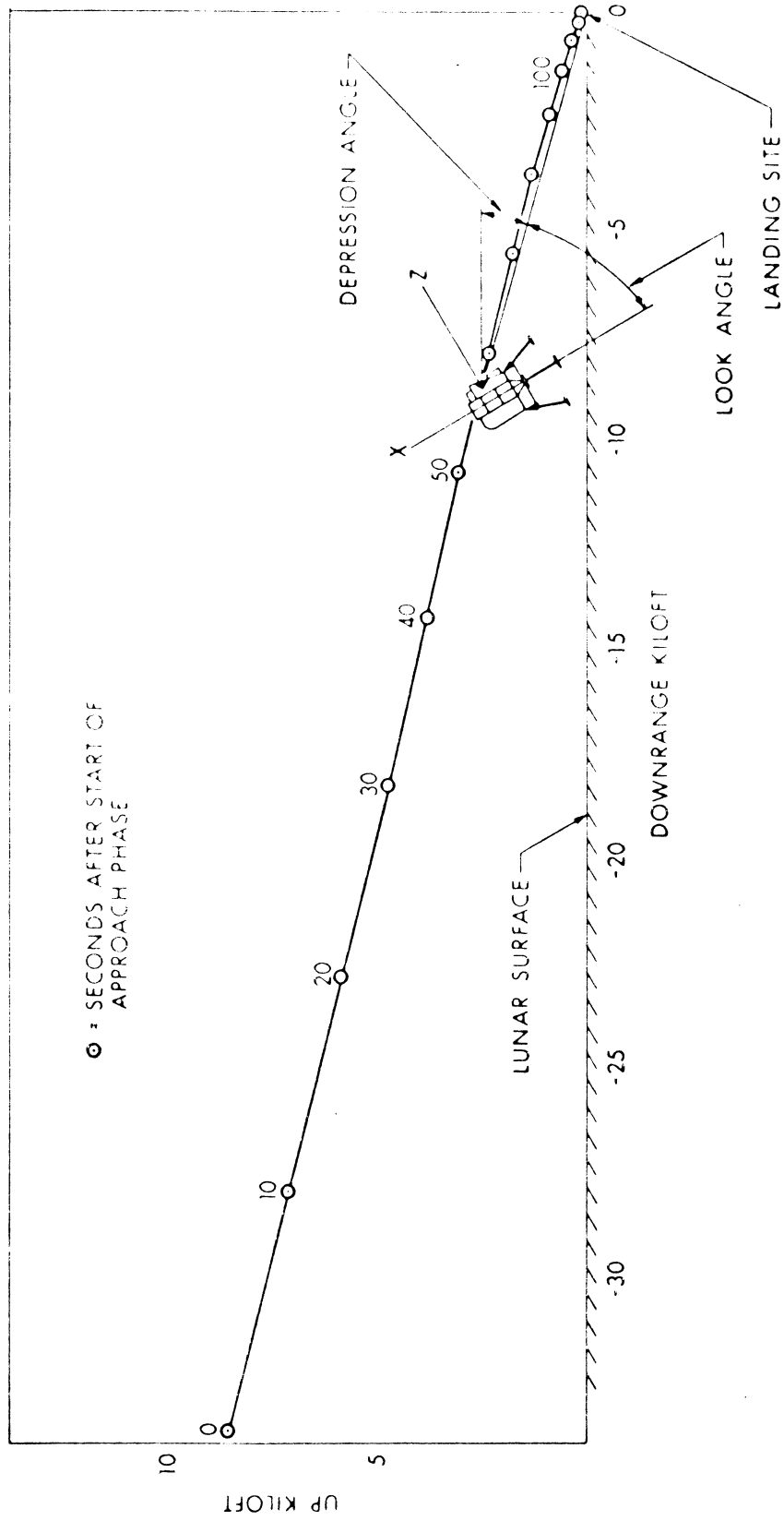

Fig. 1 Approach Phase Geometry and LEM Coordinates.

ship between altitude and altitude rate, (specifically the time to impact at the current altitude rate). The landing system provides the visibility of the surface required to make such assessments and the capability to steer clear of terrain obstructions.

2. It may be required to land at a specific site chosen before launch. Possible targets include a previously landed Surveyor, an unmanned LEM, and natural landmarks of special interest such as specific craters. ~~There is presently no plan to equip a previously landed craft with a radar beacon to which the LEM could be steered automatically. This~~ ^{is} The guidance to any of the possible landing targets ~~is made~~ by visual identification and manual steering.
3. Near the end of the descent it may probably be necessary to change the direction of the trajectory in order to approach the landing site from a direction of more favorable lighting. Certain constraints, the discussion of which is beyond the scope of this paper, require the LEM to begin its descent in a direction such that the sun is within a few degrees of the plane of the descent trajectory and directly behind the LEM. With this lighting geometry, much more detail is visible 20 or 30 degrees to the side of the approach trajectory. The steerable landing system provides a convenient method to change the direction of the trajectory near the end, where the cost in fuel of making such a change is small, and to converge on a site judged adequate through detailed scrutiny and favorable lighting.

2. Functional Description

Figure (1) is an elevation view of the approach phase of a typical landing trajectory. The trajectory is shallow, (the depression angle is small) because shallow trajectories are more efficient fuel-wise. The optimum trajectory would approach the landing site nearly horizontally. However, the shallower the trajectory, the less the detail which the crew can discern and the less apparent are any shadows cast from the rear by the sun. Thus the depression angle is a compromise between fuel cost and visibility. Note that the shaping of the trajectory produces an increasing depression angle as the landing site is approached, in the region where visibility is of prime concern.

Figure (2) shows a view through the Commander's window. Figure (2) also shows the key elements in the manual steering system, namely, the computer display, the Systems Engineer, the Commander, the landing point designator, (LPD), and the controller. Figure(3) pertains to the following description of how these elements work together to steer the LEM to the selected landing site.

At the beginning of the approach phase the LEM assumes an attitude such that the surface and the landing site are visible, the Commander visually scans the moon for the desired landing site. He will recognize it either by an appropriate marker placed by a previously landed spacecraft, as a visually identifiable landmark, or as an appropriate though unmarked site. Meanwhile, the LEM guidance computer orients the LEM about the X body axis, (Figure 1) such as to keep the current site (that resulting from previous steering, if any, where the LEM will land if there is no further steering) in the ZX plane of the LEM. The computer also repetitively calculates the look angle (Figure 1) of the current site and displays the angle. The Systems Engineer repetitively reads the angle from the display and speaks it to the Commander. The Commander identifies the current site by sighting through the LPD* and observes the angular error, if any, between the current site and the desired site. If the angular error is significant, he steers the current landing site into coincidence with the desired site by manipulating the controller.

* Figure (2) does not show that there are two LPD scales, one inside the window, one outside, to allow the Commander to register his eye.

COMPONENTS OF THE STEERABLE LANDING SYSTEM

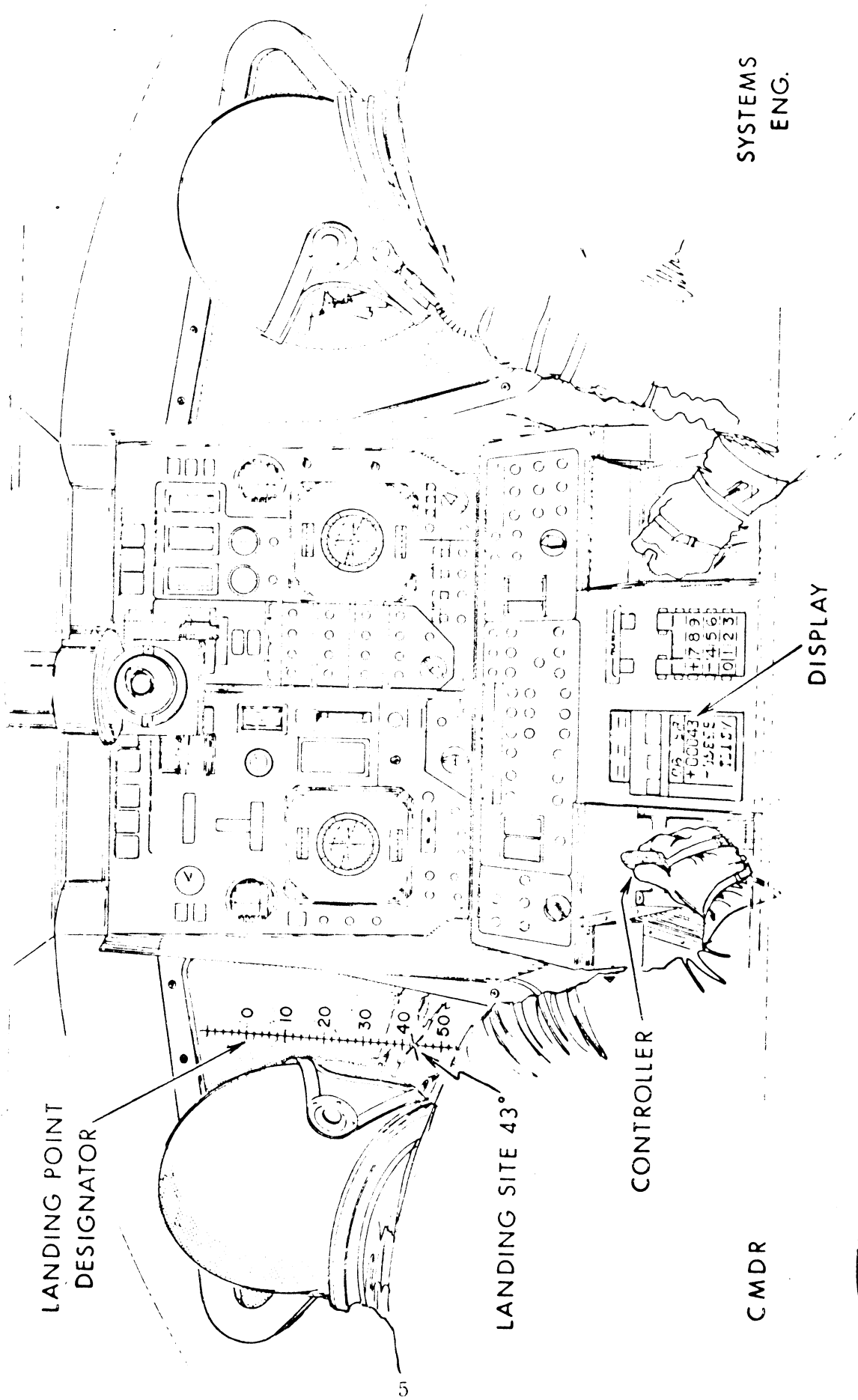

JOB NO. TP# PROJ. CLASS FIG. NO.



M.I.T. INSTRUMENTATION LABORATORY TP#

W13206086

Fig. 2

APPROACH PHASE GUIDANCE

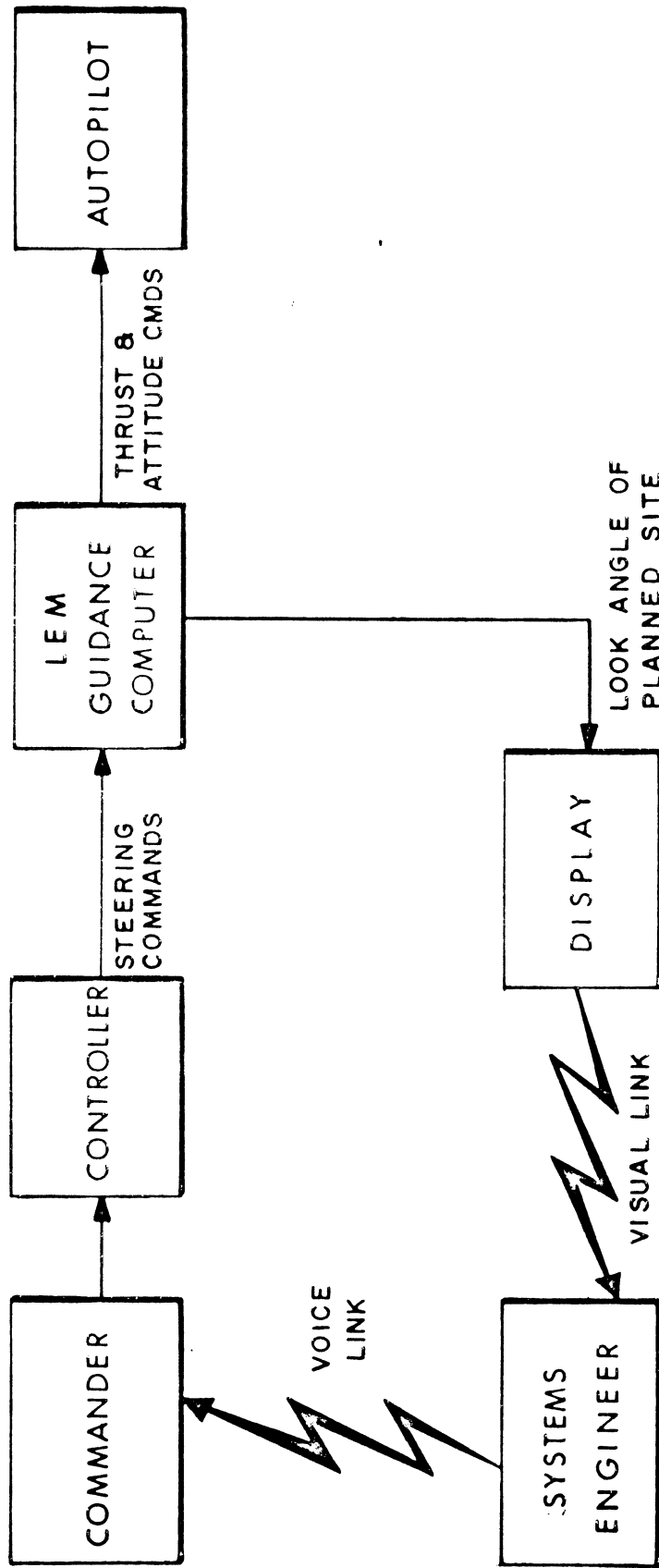

Fig. 3

Meanwhile the computer repetitively plans the trajectory to the current site. This consists of adjusting the time remaining in the phase such as to provide suitable visibility and adjusting the terminal conditions such as to keep the position, velocity, and acceleration vectors; the planned landing site vector; and the LEM Y and Z axes all coplanar at the approach phase terminus, (typically 117 ft. altitude). That is, any two of these may be used to define the plane of the trajectory at terminus, and all others will lie in this plane. From among the class of trajectories at the disposal of the computer, it provides that trajectory which arrives at the phase terminus in very nearly the shortest time, and uses very nearly the least fuel, consistent with the constraints on visibility etc.

The commander may steer up until about 15 seconds prior to the end of the phase, when the computer will stop accepting steering commands.

Each manipulation of the controller causes the computer to change the landing site by a fixed angular increment as seen by the Commander. This angular increment is resolved in body coordinates. Thus the effect of a steering command appears the same to the Commander regardless of the LEM attitude or the range to the current site. Because the magnitude of the angular increment is the same at all points along the trajectory, the response of the spacecraft to an incremental command is very nearly the same at any point. It is not possible to inadvertently introduce a gross site redesignation which could result in violent response in thrust magnitude and spacecraft attitude.

3. Design Objectives for Guidance Logic, Attitude Control Logic, and Trajectories

The following list of design objectives has been used as a starting point upon which to approach the design of the guidance and attitude control logic and upon which to choose the parameters for a first cut at trajectory design. The numbers quoted are in all cases arbitrary, they have no official sanction. They are listed here only to demonstrate that given a reasonable set of specifications in this format, the guidance and attitude control logic make it possible to design trajectories which meet the specifications.

Figure (4) shows a landing footprint which was chosen as an arbitrary objective for steering capability. This footprint shows that if a landing maneuver were initiated at some altitude H_0 , (roughly 8000 ft. for the sample trajectory described in Section 7) and at a ground range of $4 H_0$ from the current landing site, then the objective is to be able to reach any landing point in an ellipse extending $3 H_0$ in front of the current site and $5/8 H_0$ to either side. Any trajectory produced by redesignation at this initial point and landing anywhere in the ellipse should meet all the objectives. Trajectories can be flown which land outside of the footprint, but they may fail to meet one or more of the constraints.

It may be noticed from Fig. (4) that the entire landing footprint lies forward from the unredesignated landing site. This permits the preplanned trajectory (unredesignated) to use minimum fuel consistent with visibility constraints, i. e., on the preplanned trajectory, visibility is barely within the required limits. Forward steering would improve visibility, backward steering would degrade visibility beyond the visibility limits.

A. Characteristic Velocity Objectives

- 1) The characteristic velocity shall be near the minimum consistent with meeting the other objectives.

B. Steering Objectives

- 1) It shall be possible to select and steer to a new landing site anywhere within the landing footprint of Ref. 1 with the resulting trajectory meeting all of the design objectives, providing the gross targeting correction is completed in the first 15 seconds of the approach phase.

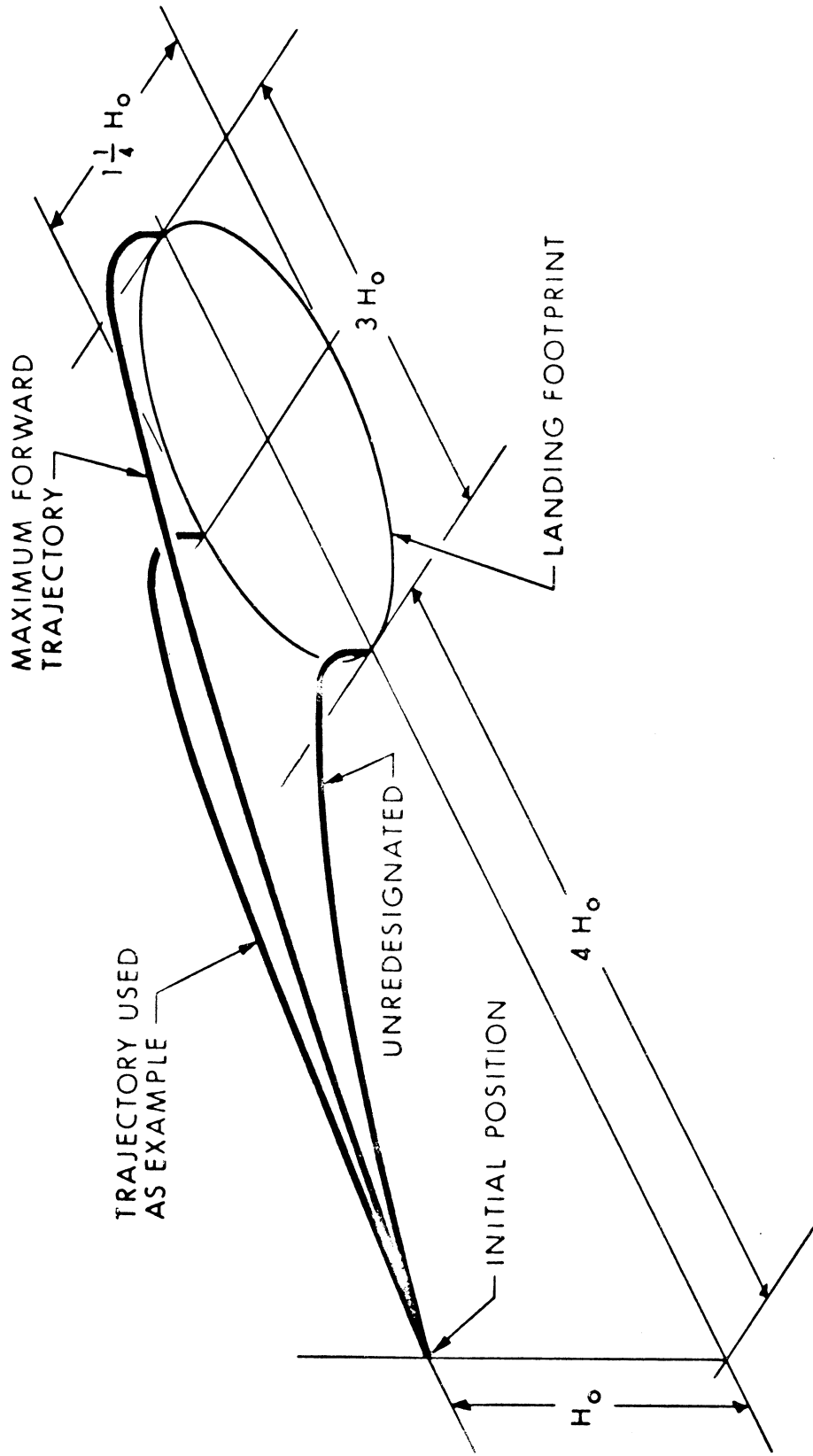

Fig. 4 Landing Footprint - An Objective for Steering Capability.

2) It shall be possible to select and steer to a new landing site at any time during the approach phase, but it shall be the responsibility of the Commander to use proper judgement in the magnitude and rate of application of the site redesignation such as to maintain adequate visibility and attitude excursion limits.

3) It shall be possible to steer to convergence upon a previously selected site throughout the approach phase as long as the site is visible.

C. Visibility Objectives

1) The landing site shall lie at least 10° above the bottom edge of the window (the look angle shall be at least 35°) from the beginning of the approach phase, for a minimum of 75 seconds, and until it recedes from view at the bottom of the window just prior to phase terminus.

2) The landing site shall not recede from view at greater than 300 ft. slant range.

3) No site redesignation within the conditions of objective B1 shall cause the landing site to disappear.

4) The angle of depression of the landing site (the angle between the vector to the site and the local horizontal) shall be greater than 15° for at least 15 seconds prior to loss of visibility.

D. Attitude Objectives

1) The attitude shall be controlled such as to keep the landing site in the LEM ZX plane at all times when thrust pointing requirements permit site visibility, and such as to minimize the angle between the normal to the trajectory plane and the LEM Y axis when thrust pointing requirements do not permit visibility. Transition between these two control criteria shall be smooth.

2) Attitude limits during the approach phase, including the effects of site redesignation, shall be 0° to 50° in pitch, and $\pm 30^{\circ}$ in bank, as defined in Section 5.

3) As the phase terminus is approached, the LEM pitch axis shall approach horizontal and the pitch angle shall approach a value not exceeding 15° .

E. Path and Velocity Objectives

1) In the plan view of the path from the redesignation point to the landing site, the center of curvature shall lie to the same side of the path at all points along the path, i. e., no S turns in the plan view.

2) The rate of descent as a function of altitude shall be a smooth curve from a point at 400 ft. altitude not exceeding 20 ft./sec., to nominally 0 ft./sec. (hover) at an altitude of at least 100 ft.

3) The forward velocity as a function of altitude shall be a smooth curve between points at 400 ft. altitude not exceeding 70 ft./sec., at 200 ft. altitude not exceeding 30 ft./sec., and nominally 0 ft./sec. at hover altitude and below.

4. Guidance Theory

It has been found by trial that the objectives for the landing system can be met using guidance equations equivalent to Eqs. (266) and (267) of Ref. 1.

The object of the guidance equations is to produce a trajectory which satisfies a three dimensional boundary value problem in a given time. The time may be adjusted to meet certain constraints, but whatever the time for meeting the end conditions finally turns out to be, the boundary conditions in all three dimensions must be met simultaneously at this time.

The equations command a total acceleration vector (gravity plus thrust acceleration) each of whose components is a quadratic function of time. Thus, to satisfy the given boundary value problem in the given time, the guidance equations yields for each acceleration component three terms; a constant term, a term proportional to time, and a term proportional to the square of time. With three parameters to choose, three terminal boundary conditions can be satisfied in each dimension. These equations are written to satisfy boundary conditions on final position, final velocity, and final acceleration.

With quadratic acceleration, the terminal boundary conditions can be achieved in any time. Therefore time is arbitrary and constitutes an additional degree of freedom. Consequently it can be chosen such as to satisfy one additional boundary condition. In this system time is chosen such as to satisfy a terminal boundary condition on the horizontal downrange component of the derivative of acceleration, jerk.

Hereafter the first derivative of acceleration will be called by its usual name, jerk, \underline{J} , and the second derivative of acceleration will be called snap, \underline{P} . Because the trajectories are always flown to some nominal set of boundary conditions which are met at terminus, it is convenient to define time relative to the time of terminus. This will be called relative time, TTF. Thus TTF is given by $TTF = T - TF$ where T is current time, TF is final time. Note that enroute TTF is negative.

With these definitions the commanded total acceleration during a guided phase is given by

$$\underline{AC} = \underline{AD} + \underline{JF} TTF + \frac{1}{2} \underline{P} TTF^2 \quad (1)$$

where \underline{AD} is the desired terminal acceleration, (tagged D because it is a desired, directly controllable quantity) and \underline{JF} is the final value of jerk, (tagged

F because it is a final value which cannot be controlled).

The object is to find an expression for the final jerk to use as a basis for setting the relative time, and an expression for the commanded acceleration to use as a basis for generating thrust commands. An expression for snap will be an unused byproduct.

From the equations of motion, and assuming the total acceleration and the commanded acceleration are identical, we have for the current values of the variables

$$\begin{bmatrix} \underline{AC} \\ \underline{V} \\ \underline{R} \end{bmatrix} = \begin{bmatrix} \underline{AD} + \underline{JF} \text{ TTF} + \frac{1}{2} \underline{P} \text{ TTF}^2 \\ \underline{VD} + \underline{AD} \text{ TTF} + \frac{1}{2} \underline{JF} \text{ TTF}^2 + \frac{1}{6} \underline{P} \text{ TTF}^3 \\ \underline{RD} + \underline{VD} \text{ TTF} + \frac{1}{2} \underline{AD} \text{ TTF}^2 + \frac{1}{6} \underline{JF} \text{ TTF}^3 + \frac{1}{24} \underline{P} \text{ TTF}^4 \end{bmatrix}, \quad (2)$$

where \underline{V} and \underline{R} are the current velocity and position and \underline{VD} is the desired terminal velocity. All vectors are considered to be row vectors, therefore Eq. (2) is a 3×3 matrix equation. We wish to solve for the unknowns \underline{P} , \underline{JF} , and \underline{AC} in terms of the remaining quantities. The unknowns may be separated by transposing terms

$$\begin{bmatrix} \underline{AD} \\ \underline{V} - \underline{VD} - \underline{AD} \text{ TTF} \\ \underline{R} - \underline{RD} - \underline{VD} \text{ TTF} - \frac{1}{2} \underline{AD} \text{ TTF}^2 \end{bmatrix} = \begin{bmatrix} \underline{AC} - \underline{JF} \text{ TTF} - \frac{1}{2} \underline{P} \text{ TTF}^2 \\ \frac{1}{2} \underline{JF} \text{ TTF}^2 + \frac{1}{6} \underline{P} \text{ TTF}^3 \\ \frac{1}{6} \underline{JF} \text{ TTF}^3 + \frac{1}{24} \underline{P} \text{ TTF}^4 \end{bmatrix} \quad (3)$$

and by factoring the right hand side

$$= \begin{bmatrix} -\frac{1}{2} \text{ TTF}^2 & - \text{ TTF} & 1 \\ \frac{1}{6} \text{ TTF}^3 & \frac{1}{2} \text{ TTF}^2 & 0 \\ \frac{1}{24} \text{ TTF}^4 & \frac{1}{6} \text{ TTF}^3 & 0 \end{bmatrix} \begin{bmatrix} \underline{P} \\ \underline{JF} \\ \underline{AC} \end{bmatrix} \quad (4)$$

Then the unknown snap, final jerk, and current (commanded) acceleration are found by inverting the left matrix,

$$\begin{bmatrix} \underline{P} \\ \underline{JF} \\ \underline{AC} \end{bmatrix} = \begin{bmatrix} 0 & 24/\text{TTF}^3 & -72/\text{TTF}^4 \\ 0 & -6/\text{TTF}^2 & 24/\text{TTF}^3 \\ 1 & 6/\text{TTF} & -12/\text{TTF}^2 \end{bmatrix} \begin{bmatrix} \underline{AD} \\ \underline{V} - \underline{VD} - \underline{AD} \text{ TTF} \\ \underline{R} - \underline{RD} - \underline{VD} \text{ TTF} - \frac{1}{2} \underline{AD} \text{ TTF}^2 \end{bmatrix}. \quad (5)$$

The expressions for \underline{P} , \underline{JF} , and \underline{AC} may be simplified by multiplying out the right hand side. This yields

$$\underline{P} = 12 \underline{AD}/\text{TTF}^2 + 24 \underline{V}/\text{TTF}^3 + 48 \underline{VD}/\text{TTF}^3 - 72 (\underline{R} - \underline{RD})/\text{TTF}^4, \quad (6)$$

$$\underline{JF} = -6 \underline{AD}/\text{TTF} - 6 \underline{V}/\text{TTF}^2 - 18 \underline{VD}/\text{TTF}^2 + 24 (\underline{R} - \underline{RD})/\text{TTF}^3, \quad (7)$$

$$\underline{AC} = \underline{AD} + 6 (\underline{V} + \underline{VD})/\text{TTF} - 12 (\underline{R} - \underline{RD})/\text{TTF}^2. \quad (8)$$

The relative time TTF may be found using the cubic Eq. (7) in the horizontal downrange dimension and a specified value for this component of jerk. With the relative time, Eq. (8) may be solved for the commanded acceleration. Equation (8) is equivalent to Eqs. (266) and (267) of Ref. 1.

5. Definitions of Coordinates, Attitude Angles and Gimbal Angles

Five coordinate systems are used in guidance. These must be defined in order to describe the functions performed by the guidance equations.

The coordinate systems defined here are those carried by the guidance computer, including the effects of any errors which have propagated during the preceding period of navigation and guidance. These coordinates are as the computer knows them; the inertial coordinates are not strictly non-rotating, they rotate as a consequence of sensor errors; the lunar-fixed coordinates are not strictly fixed in the moon, they rotate relative to the moon also as a consequence of sensor errors.

Figure 5 pertains to the following coordinate definitions.

1. Body coordinates: these are the generally accepted LEM coordinates. The X axis is in the direction of the nominal thrust vector, the Z axis is in the direction forward from the design eye, and the Y axis completes a right hand triad XYZ. Variables in body coordinates are tagged B.
2. Inertial coordinates: these are the generally accepted Inertial Measurement Unit Coordinates. The origin is at the center of the moon, the X axis pierces the initially chosen landing site at the initially chosen nominal landing time, the Z axis lies in the plane of the initially planned trajectory relative to the moon and points forward, and the Y axis completes a right hand triad XYZ. Thus if the LEM lands at the nominal site at the nominal time and in an erect and nominal attitude, the inertial and body coordinates will be parallel at the instant of landing. Variables in inertial coordinates are tagged I.
3. Lunar-fixed coordinates: the origin is at the center of the moon, the X axis pierces the initial site continuously, the Z axis is in the plane of the initially planned trajectory relative to the moon and points forward, and the Y axis completes a right hand triad XYZ. Lunar-fixed coordinates rotate with the moon and are fixed with respect to the moon irrespective of site redesignations. Thus at the nominal landing time the lunar-fixed coordinates coincide with the inertial coordinates, and if the LEM is landed at the nominal site at that time in an erect and nominal attitude, the coincident inertial and lunar-fixed coordinates are at that instant parallel to the body coordinates. Variables in lunar-fixed coordinates are untagged.

4. Guidance coordinates: the origin is at the aim position of the phase, the X axis is vertical, the Z axis lies in the plane of the trajectory relative to the moon at the terminus of the phase and points forward, and the Y axis completes a right hand triad XYZ. Thus, the origin and the orientation of the guidance coordinate frame are altered each time the landing site is redesignated. Variables in guidance coordinates are tagged G.
5. Terminal coordinates: the origin is at the current landing site, the X axis is vertical, the Z axis lies in the plane of the trajectory relative to the moon at approach phase terminus and points forward, and the Y axis completes a right hand triad XYZ. Thus during the approach phase the terminal and guidance coordinates are parallel and during the vertical descent they are coincident. Variables in terminal coordinates are tagged T.

The attitude angles and the gimbāl angles are different sets of Euler angles defined as follows:

Starting with the body frame parallel to the lunar-fixed frame

Heading	Inner Euler Angle	Rotation about X axis
Pitch	Middle Euler Angle	Rotation about displaced Y axis
Bank	Outer Euler Angle	Rotation about displaced Z axis

Starting with the body frame parallel to the inertial frame

Inner Gimbal Angle	Inner Euler Angle	Rotation about Y axis
Middle Gimbal Angle	Middle Euler Angle	Rotation about displaced Z axis
Outer Gimbal Angle	Outer Euler Angle	Rotation about displaced X axis

HOWEVER, THE LANDING SITE IN INERTIAL COORDINATES IS SOFT-WIRED AND COULD BE CHANGED IN FLIGHT AS REQUIRED.

6. Steering and Guidance Computations

Figure 6 is a block diagram of the guidance system for the approach phase. Although this is a digital system, it is also a closed loop or feedback system and the block diagram format seems to better display the essential feedback characteristics than would a customary digital logic diagram. Of course the operations represented by the blocks are performed sequentially rather than continuously, and there are time delays in the feedback information. The inputs to blocks which do not come from other blocks, (e.g., the landing site in guidance coordinates), are constants wired into fixed memory in the guidance computer. The block diagram is divided into four sections.

1. The manual steering section simply provides the targeting equations and the guidance equations with an aim position.
2. The targeting equations determine the remaining targeting parameters including the relative time, aim velocity, aim acceleration, and the new landing site.
3. The guidance equations yield the attitude errors and the throttle commands.
4. The guidance execution section is a catch-all containing everything required to carry out the guidance commands and to produce the input data for the guidance system.

The sections of the block diagram are processed successively from left to right, and iteratively with a time interval of one to several seconds. Of course it takes a finite time to process each section and the real variables change during the processing time. Obviously the guidance commands would be erroneous if based on position of one time, velocity of another time, attitude of a third time, etc. For this reason, the position, velocity, attitude, etc. are all determined as of a specific time, and all pertinent variables and the time at which they apply are stored. Thus a time-consistent set of variables is used throughout a given pass through the guidance computations, none are changed until processing is completed.

One exception to this is necessary in the targeting equations section. Because there is a closed loop in this section and each operation in the loop is performed only once during one pass, one operation must use outdated data. The note (i-1) on the guidance coordinate unit vectors supplied for

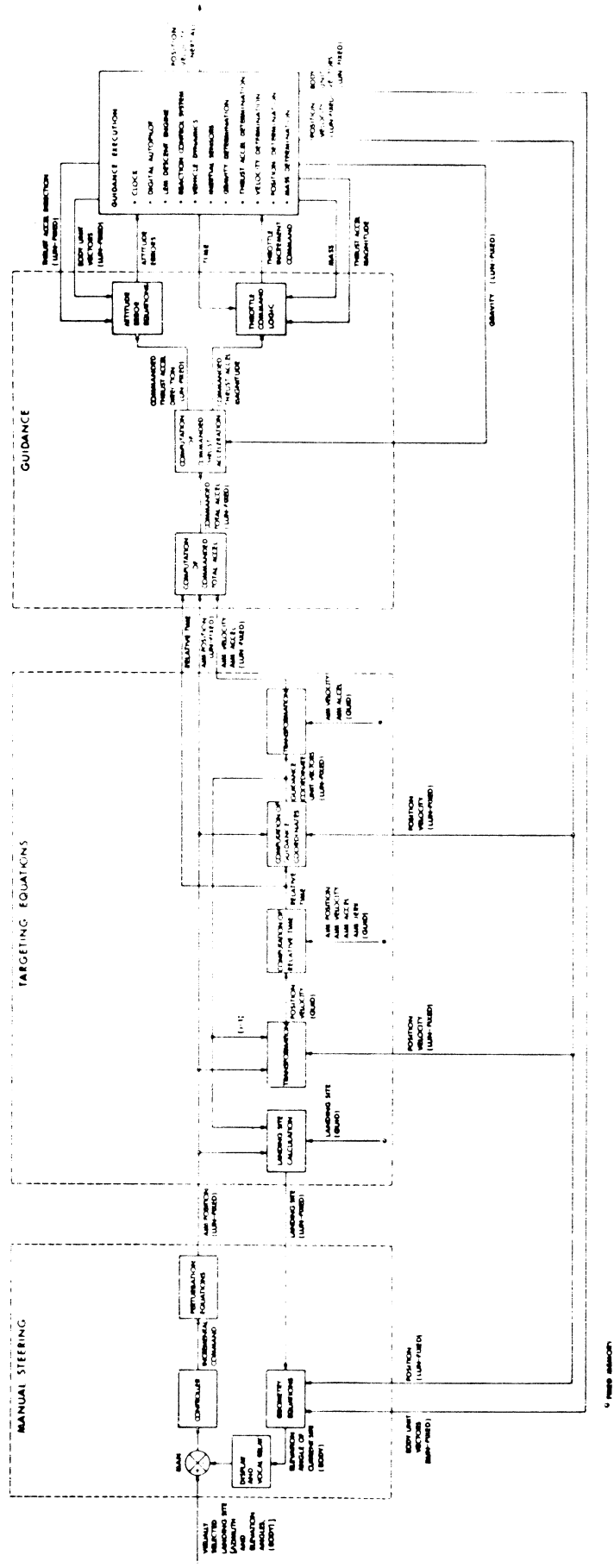

Fig. 6 Approach Phase Guidance In Detail.

the transformation of position and velocity indicates these unit vectors are always one cycle behind. Simulation of this loop has revealed no detrimental effects from using this approximation.

6.1 Manual Steering

As described previously, the steering commands are produced by the Commander manipulating his controller. There is no way to synchronize his commands with the processing of the guidance computations. Consequently it is necessary to simply interrupt the computer when a steering command is received, increment or decrement the command count, and store the count for processing later. It is conceivable a maximum count would trigger processing the guidance computations, though this has not been decided. When the perturbation equations (the equations which produce a new aim position) are processed, the count is reset to zero.

The angular increment to be imparted to the landing site due to one fore-aft manipulation of the controller has been tentatively selected on the basis of digital and analog simulation to be $1/2^\circ$ elevation angle as seen by the Commander. The increment due to one left-right manipulation has been tentatively selected to be 2° in azimuth as seen by the Commander.

The first step in the manual steering process is to display the number which tells the Commander where to look to see the current landing site. Making use of the fact that the LEM attitude is controlled such that the current landing site is kept in the LEM pitch plane, (ZB XB), the number displayed by the computer is calculated as

$$QLDIS = \text{ARCSIN} (-\text{UNLRB}_0) \quad (9)$$

where UNLRB is a unit vector toward the current landing site from the current LEM position, in body coordinates, and X, Y, Z vector components are numbered 0, 1, 2.

When steering commands are received, a flag is set which causes the perturbation equations to be processed on the next pass. For computational simplicity, processing the perturbation equations produces directly an increment in the aim position, not the landing site. The corresponding new landing site is computed later. In the example used here the aim position is 117 ft. above and 3.33 ft. back from the landing site.

The perturbation equations first determine a point near the surface displaced by the proper angle from the current landing site, (see Fig. 7). Then the new aim position is placed directly above this point. The horizontal displacement between the landing site and the aim position, (3.33 ft. in the example presented), is ignored.

Thus a vector in lunar-fixed coordinates to the displaced point near the surface is calculated as

$$\underline{VCT} = \text{CB} \begin{bmatrix} \text{UNLRB}_0 + \text{NCEL ELPRT UNLRB}_2 \\ \text{UNLRB}_1 + \text{NCAZ AZPRT} \\ \text{UNLRB}_2 - \text{NCEL ELPRT UNLRB}_0 \end{bmatrix} \quad (10)$$

where NCEL is the elevation command count, ELPRT is the elevation angular increment in radians, NCAZ and AZPRT are the azimuth command count and azimuth increment, and CB is the matrix of transformation from body to lunar-fixed coordinates. The new aim position is then calculated as

$$\underline{RD} = (\text{RM} + \text{H2F})(\text{UNIT}(\underline{R} + \underline{VCT}(\underline{L}_0 - \underline{R}_0)/\text{VCT}_0)) \quad (11)$$

where RM is the lunar radius, H2F is the altitude of the aim position, \underline{R} is the current LEM position, and \underline{L} is the current landing site position.

6.2 Targeting

With the aim position computed, the remaining targeting parameters must be found such that the resulting trajectory will meet the objectives of section 3. To meet the terminal attitude objectives and to avoid S turns in the plan view of the trajectory to the redesignated landing site, the remaining targeting parameters must be computed to satisfy certain coplanar conditions.

6.2.1 The Coplanar Conditions

Although the guidance equations derived in section 3 are written to satisfy terminal conditions only on position, velocity, acceleration, and one component of jerk, it is the object of the targeting equations to force the guidance system to satisfy an additional constraint: As the phase

AIM POSITION PERTURBATION GEOMETRY

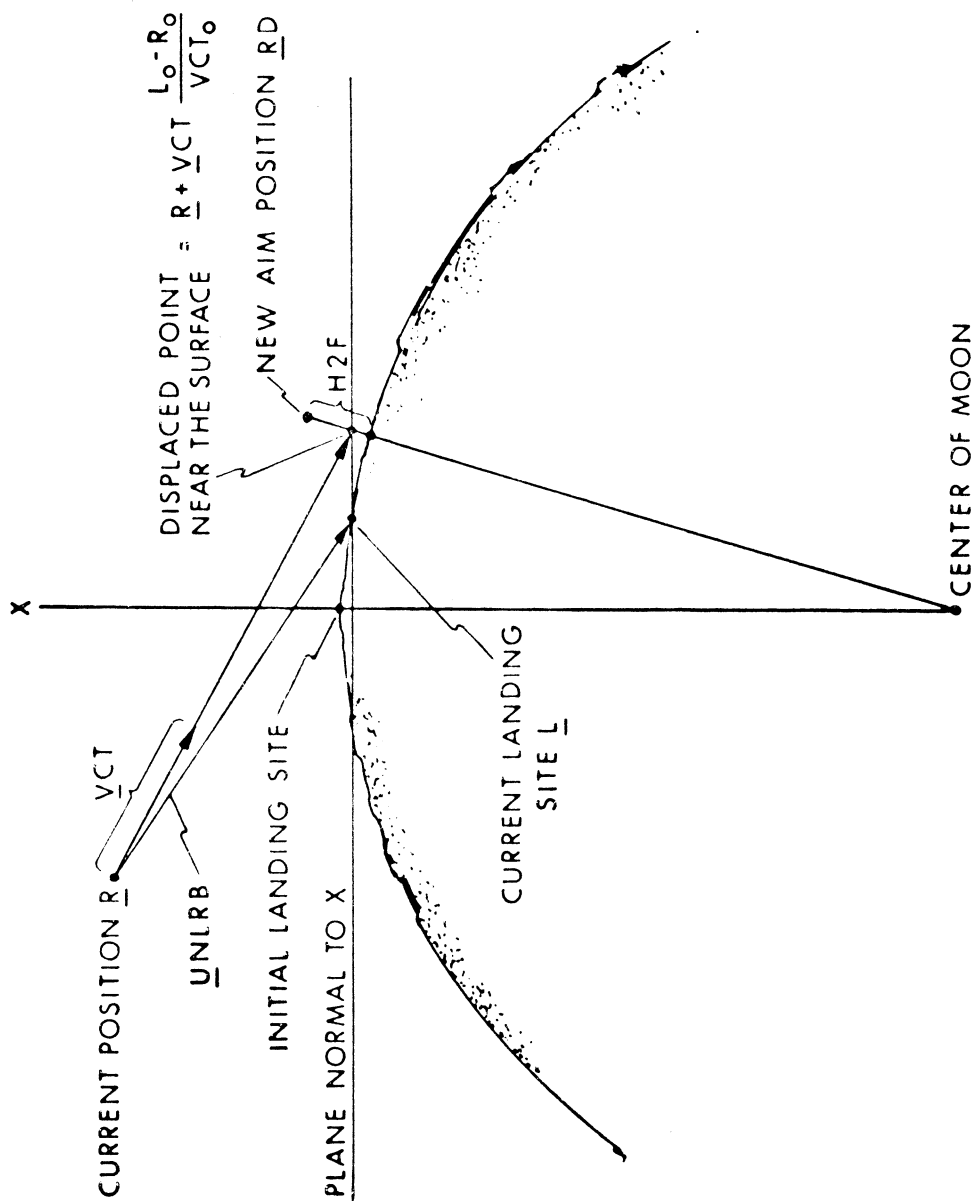

JOB NO. TP# _____
 PROJ. # _____
 FOR _____
 BY _____
 DATE _____
 FIG. NO. _____
 CLASS _____



M.I.T. INSTRUMENTATION LABORATORY — TP# _____

W13206087

Fig. 7

terminus is approached, the plane of the trajectory, which may be defined by the position and velocity vectors, shall also contain the acceleration vector, the jerk vector, the landing site vector, and the body Z and X axes. Several desirable features result from meeting these coplanar conditions.

1. By satisfying the coplanar jerk requirement, the body angular rate vector is automatically normal to the trajectory plane at phase terminus.
2. By satisfying the coplanar body X and Z axes requirement, the body angular rates, except for pitch, are automatically zero at phase terminus.
3. In the plan view of the path to the redesignated site, the center of curvature will lie on the same side at all points along the path.

The approach to meeting the coplanar constraints is to specify the aim acceleration, aim velocity, and the landing site in a coordinate frame which is rotated about the vertical in response to steering commands.* This is the guidance coordinate frame. There is a unique orientation for this frame, (illustrated in Fig. 8), which satisfies the coplanar conditions. This is demonstrated as follows.

Assume the frame is properly oriented, i. e. such that the YG component of the final jerk is zero. The YG component of the final velocity and final acceleration will of course also be zero, by specification. Because the origin of the guidance frame is the aim position, the YG component of the final position is also zero. Therefore we conclude that in this frame the YG components of all final values are zero except snap. From Eq. (2) we have for the current values of the YG components of velocity and position,

$$VG_1 = VDG_1 + ADG_1 TTF + \frac{1}{2} JFG_1 TTF^2 + \frac{1}{6} PG_1 TTF^3, \quad (12)$$

$$RG_1 = RDG_1 + VDG_1 TTF + \frac{1}{2} ADG_1 TTF^2 + \frac{1}{6} JFG_1 TTF^3 + \frac{1}{24} PG_1 TTF^4 \quad (13)$$

* This problem was first solved by a numerical iterative approach. A closed form solution (by a somewhat different approach than presented here) was first suggested by Thomas E. Moore of the Manned Spacecraft Center, Houston, Texas.

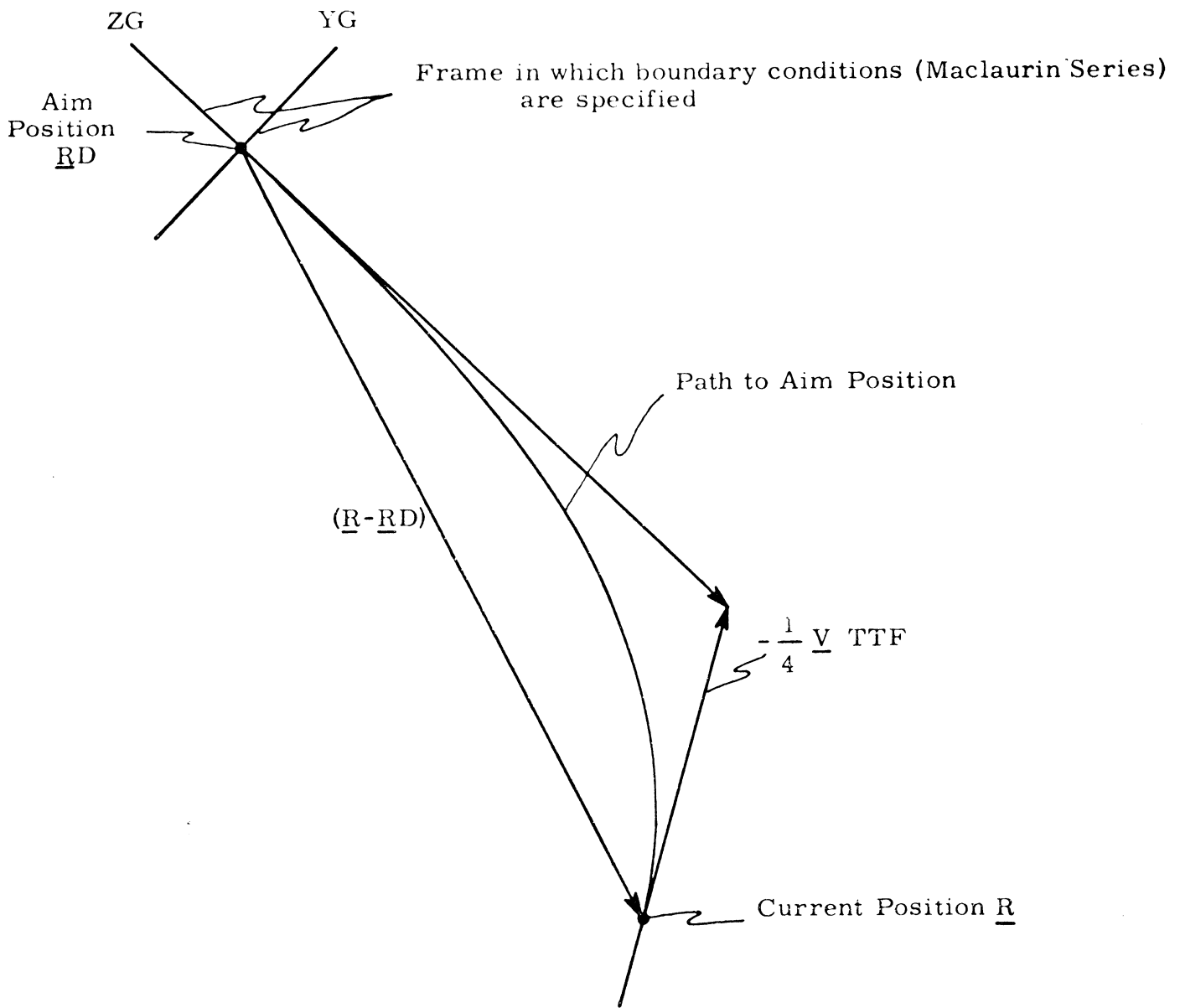

Fig. 8 Plan View Showing Orientation of the Guidance Coordinate Frame.

where all terms on the right are zero except the snap terms. Thus we have remaining

$$\underline{V}G_1 = \frac{1}{6} \underline{P}G_1 \text{TTF}^3 \quad (14)$$

$$\underline{R}G_1 = \frac{1}{24} \underline{P}G_1 \text{TTF}^4. \quad (15)$$

Equations (13) and (14) may be combined to yield

$$\underline{R}G_1 - \frac{1}{4} \underline{V}G_1 \text{TTF} = 0, \quad (16)$$

which is equivalent to

$$(\underline{R}G - \frac{1}{4} \underline{V}G \text{TTF})_1 = 0. \quad (17)$$

This indicates the YG axis must be perpendicular to the vector $(\underline{R} - \underline{R}D) - \frac{1}{4} \underline{V} \text{TTF}$ as shown in Fig. (8), or, equivalently, to the vector $4(\underline{R} - \underline{R}D) - \underline{V} \text{TTF}$.

6.2.2 Targeting Concepts Summary

The targeting concepts developed here and in section 3 may be summarized as follows. in the order in which the computations are performed:

1. There is a guidance coordinate frame in which the aim conditions are specified and are invariant.
2. The origin of this frame is located to coincide with the aim position.
3. Relative time TTF is computed such as to satisfy a boundary value requirement on the ZG component of the terminal jerk.
4. The frame is rotated about the vertical such that the final jerk will lie in the ZG XG plane.
5. The landing site and all aim parameters may be transformed from their invariant values in this frame to the lunar-fixed frame in which the guidance equations are solved.

From the above targeting philosophy it is seen that the trajectory to the aim position is a Maclaurin time series, in the guidance coordinate frame, centered at the aim position. All terms in this series through acceleration in the vertical direction and jerk in the down range and cross range directions are invariant with respect to landing site redesignation. Therefore, in the guidance coordinate frame, and in the vicinity of the aim position, the shape of trajectories will be very insensitive to manual steering.

6.2.3 Targeting Computations

Relative time is computed using Newton's method upon variables in the guidance coordinate frame. The current velocity and position in this frame are calculated as

$$\underline{VG} = \overset{*}{CGT} \underline{V}, \quad (18)$$

$$\underline{RG} = \overset{*}{CGT} (\underline{R} - \underline{RD}), \quad (19)$$

where $\overset{*}{CGT}$ is the transformation matrix to the guidance frame from the lunar-fixed frame. This matrix was computed on the previous iteration. A first guess for the relative time is simply

$$TTF = T - TF \quad (20)$$

where T is the current time and TF is the final time which was computed on the previous iteration. Because of numerical advantages, the reciprocal of the relative time is calculated as

$$TTFR = 1/TTF \quad (21)$$

and used to compute the final downrange jerk component using an equation similar to Eq. (7),

$$JFG_2 = -6ADG_2 TTFR - 18VDG_2 TTFR^2 - 6VG_2 TTFR^2 + 24RG_2 TTFR^3. \quad (22)$$

The derivative of JFG_2 with respect to TFR is calculated as

$$DERJFG_2 = -6 ADG_2 - 36 VDG_2 TFR - 12 VG_2 TFR + 72 RG_2 TFR^2. \quad (23)$$

Finally TFR is recomputed as

$$TFR = TFR + (JDG_2 - JFG_2) / DERJFG_2 \quad (24)$$

where JDG_2 is the desired terminal jerk component in guidance coordinates. This process is repeated, if necessary, until the change in TFR is below a specified percentage. Finally the relative time and the final time are calculated as

$$TTF = 1/TFR, \quad (25)$$

$$TF = T - TTF. \quad (26)$$

The new guidance coordinate unit vectors may now be calculated as suggested by Fig. (8). Thus

$$\overset{*}{CGT} = \begin{bmatrix} \text{UNIT}(\underline{RD}) \\ \text{UNIT}(\underline{CGT}_0 * (4(\underline{R} - \underline{RD}) - \underline{V} TTF)) \\ \underline{CGT}_0 * \underline{CGT}_3 \end{bmatrix} \quad (27)$$

where \underline{CGT}_0 , \underline{CGT}_3 and \underline{CGT}_6 are the row vectors of $\overset{*}{CGT}$, and $*$ between two vectors indicates the cross product.

Finally, the aim velocity, aim acceleration, and the new landing site are computed as

$$\underline{VD} = \overset{*}{CG} \underline{VDG}, \quad (28)$$

$$\underline{AD} = \overset{*}{CG} \underline{ADG}, \quad (29)$$

$$\underline{L} = \overset{*}{CG} \underline{LG} + \underline{RD}, \quad (30)$$

where $\overset{*}{CG}$ is the transpose of $\overset{*}{CGT}$.

6.3 Guidance Equations

With all target parameters determined, the guidance equations must produce throttle commands and attitude error signals.

6.3.1 Commanded Acceleration and Throttle Commands

The commanded total acceleration is calculated from the current and target parameters using an equation equivalent to Eq. (8).

$$\underline{AC} = \underline{AD} + 6(\underline{V} + \underline{VD}) \text{ TFR} - 12(\underline{R} - \underline{RD}) \text{ TFR}^2. \quad (31)$$

Next the commanded thrust acceleration

$$\underline{AFC} = \underline{AC} - \underline{G} \quad (32)$$

and its magnitude

$$\text{AFC} = \text{ABVAL}(\underline{AFC}) \quad (33)$$

are calculated. Finally the thrust increment command is calculated as

$$\Delta \text{FC} = M(\text{AFC} - \text{AF}) \quad (34)$$

where M is the current mass and AF is the current magnitude of thrust acceleration. Figure (6) shows time as an input to the calculation of the throttle commands because the guidance equations may be processed so infrequently that it may be necessary to extrapolate the thrust commands.

At some time near the end of the phase it becomes numerically unfeasible to calculate the commanded acceleration by Eq. (31) because the reciprocal of relative time, TFR, becomes unbounded. After this, the commanded acceleration is calculated as a linear function of time from the value last computed by Eq. (31) to the desired terminal value. Thus when Eq. (31) is processed for the last time, the linear acceleration coefficients are stored as

$$\text{TLININ} = T, \quad (35)$$

$$\underline{\text{ALININ}} = \underline{\text{AC}}, \quad (36)$$

$$\underline{\text{JLIN}} = (\underline{\text{AD}} - \underline{\text{ALININ}})/(\text{TF} - \text{TLININ}). \quad (37)$$

Subsequently the commanded acceleration is calculated as

$$\underline{AC} = \underline{ALININ} + \underline{JLIN} (T - TLININ). \quad (38)$$

6.3.2 Attitude Error Signals

The objectives of the attitude error equations are to bring the commanded and actual thrust acceleration vectors into colinearity and to control the attitude about the thrust axis such that the current landing site is kept in the center of vision, (in the LEM ZB XB plane). Achieving the first objective is simple, but there are pitfalls in attempting to achieve the other. These pitfalls are illustrated in Fig. (9).

1. When the landing site lies on the thrust vector, the desired orientation about the thrust vector is indeterminate. Of course this is bound to occur during vertical descent and possibly also at some time near the end of the approach phase.
2. Near the end of the approach phase, the intersection of the thrust vector with the YT ZT plane of Fig. (9) may move out in the YT direction, cross the YT axis, and will terminate on the positive ZT axis. Keeping the current site in the ZB XB plane may determine an attitude throughout this process, it will certainly determine an attitude at approach phase terminus, but the attitude determined would not be what anyone would want to fly. In fact at terminus the attitude would be rotated 180° from the normal approach attitude.

Attitude error equations have been developed which seem to produce a satisfactory attitude at all times during the descent. For control about the thrust axis, (actually the error signals are used for control about the XB axis), two control criteria are used, and a smooth transition is made between these.

Figure (10) shows the geometry pertinent to generating error signals about the XB axis. In this figure NORMLRX is given by

$$\underline{NORMLRX} = \underline{UNLR} * \underline{CBT}_0 \quad (39)$$

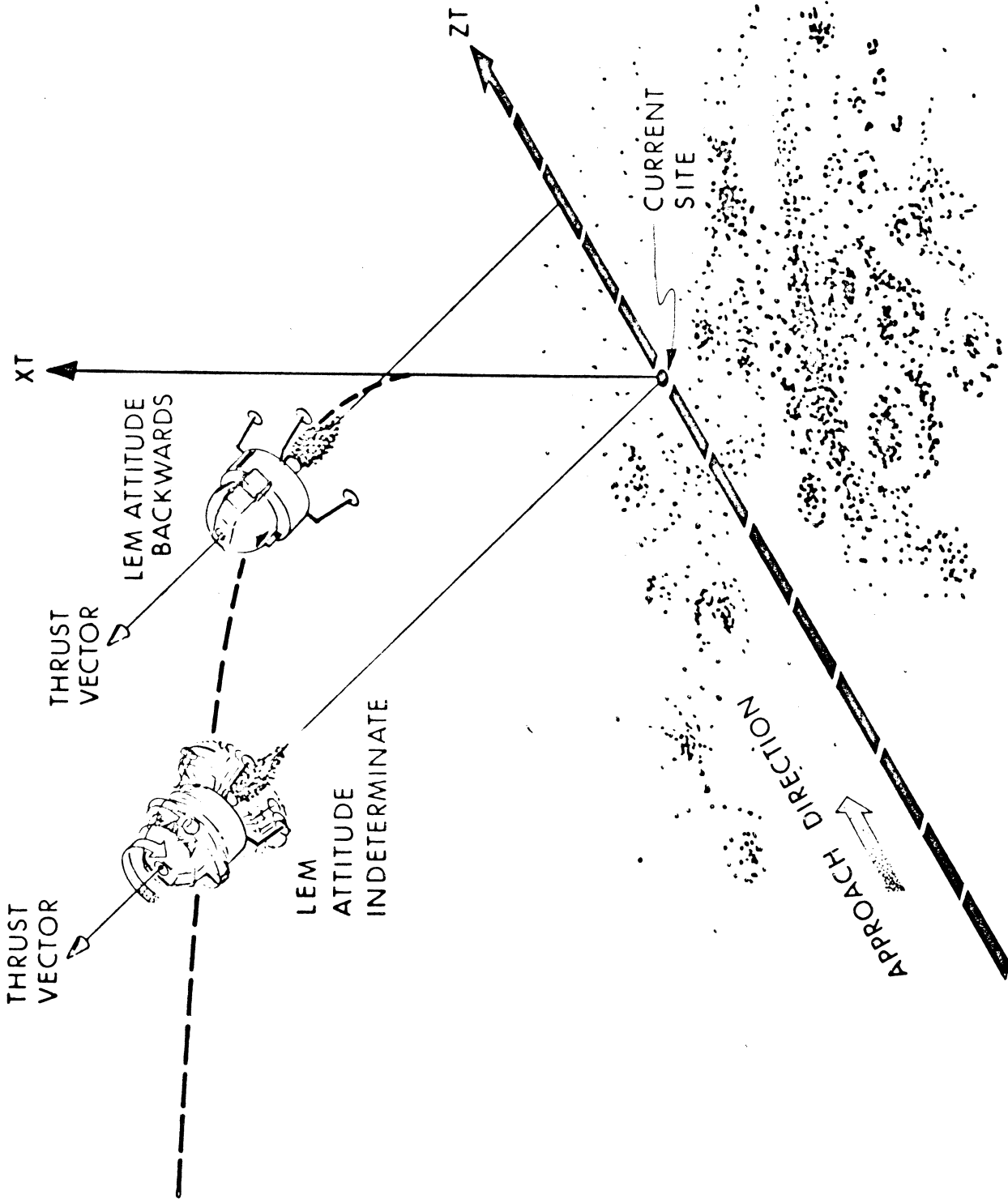

Fig. 9 Why Keeping the Landing Site in the Center of Vision cannot be the Sole Criterion for Controlling Attitude about the Thrust Axis.

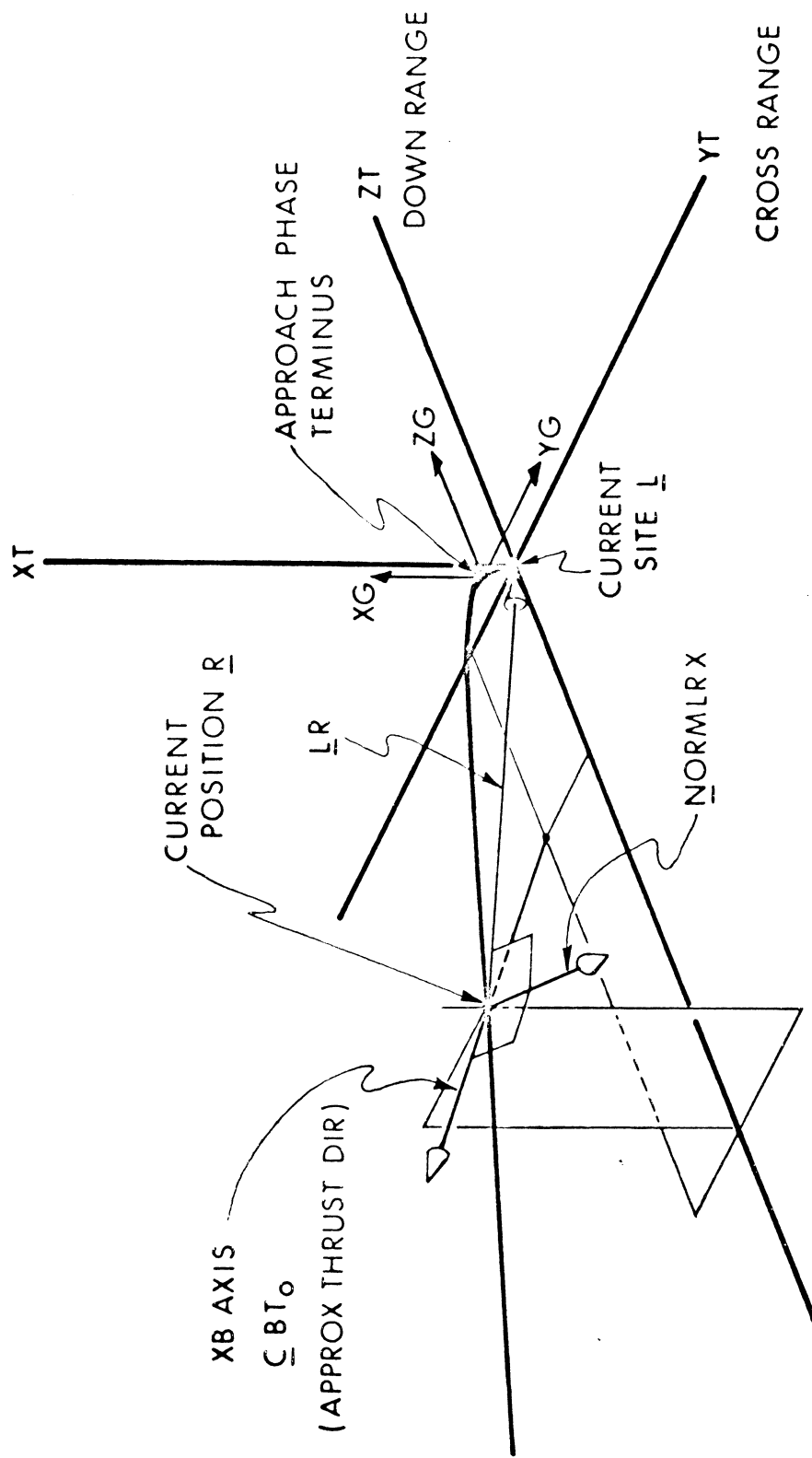

Fig. 10 Geometry Pertinent to Generation of Attitude Error Signals about the XB Axis.

where \underline{UNLR} is a unit vector in the direction of the vector \underline{LR} , and \underline{CBT}_0 is a unit vector along the XB axis. The visibility control criterion aligns the YB axis with the vector $\underline{NORMLRX}$. When this is not feasible, the alternate control criterion minimizes the angle between the YB axis and the YT axis. (It is evident these axes can not in general be aligned.) which control criterion to use it decided on the basis of the length and the sign of the projection of $\underline{NORMLRX}$ on the YT axis. It can be reasoned that this basis for selecting a control criterion will work, as follows.

The look angle (Fig. 1) is the arcsin of the magnitude of $\underline{NORMLRX}$, and thus this magnitude is an excellent indication of whether or not the landing site would be visible if the visibility control criterion were used. When the look angle would be sufficiently large to use the visibility control criterion, but the geometry becomes such that a weird attitude would result, then $\underline{NORMLRX}$ retains a reasonable length but its projection on the YT axis shrinks and may become negative; it would be negative for the case shown in Fig. (9) where the LEM is shown turned around backwards. Consequently using the length and sign of the projection of $\underline{NORMLRX}$ on the YT axis as a single basis for choosing a control criterion apparently takes care of all possible contingencies. It is left for the reader to verify that this works even when the LEM is below the YT ZT plane, as it is during most of the braking phase.

In order to avoid overflow which could occur by attempting to use the visibility criterion in an unfavorable situation, the first step in generating attitude error signals is to determine which XB axis control criterion to use. As a basis for deciding, two constants are wired into fixed memory. One is an upper limit, QBMAX, the other a lower limit, QBMIN. QBMAX is the sine of the minimum look angle, 25° , for which the landing site could be seen. If the projection of $\underline{NORMLRX}$ on the YT axis is positive and exceeds QBMAX, then the visibility control criterion is used. If the projection is less than QBMIN or is negative, then the angle between the YB and YT axes is minimized. If the projection is between these limits, both error signals are calculated and a blend is used.

The projection of $\underline{NORMLRX}$ on the YT axis is calculated as

$$QFC = \underline{NORMLRX} \cdot \underline{CTT}_3 \quad (40)$$

where \underline{CTT}_3 is a unit vector in the YT direction. If QFC exceeds QBMAX, then the XB axis error signal is calculated as

$$ERXL = (\text{UNIT}(\underline{NORMLRX})) * \underline{CBT}_3 \cdot \underline{CBT}_0 \quad (41)$$

where \underline{CBT}_3 is a unit vector in the YB direction. If QFC is less than QBMIN, then the error signal is calculated as

$$ERXT = \underline{CTT}_3 * \underline{CBT}_3 \cdot \underline{CBT}_0. \quad (42)$$

If $\text{QBMIN} < \text{QFC} < \text{QBMAX}$, then ERXL and ERXT are both calculated and used to generate a blended error given by

$$\begin{aligned} ERX = & ERXL (\text{QFC} - \text{QBMIN}) / (\text{QBMAX} - \text{QBMIN}) \\ & + ERXT (\text{QFC} - \text{QBMAX}) / (\text{QBMIN} - \text{QBMAX}). \end{aligned} \quad (43)$$

The error signals about the YB and ZB axes, required to correct the pointing of the thrust vector, are calculated as

$$ERY = \underline{UNAF}_C * \underline{UNAF} \cdot \underline{CBT}_3, \quad (44)$$

$$ERZ = \underline{UNAF}_C * \underline{UNAF} \cdot \underline{CBT}_6, \quad (45)$$

where \underline{UNAF}_C and \underline{UNAF} are unit vectors in the direction of the commanded thrust acceleration \underline{A}_C and the measured thrust acceleration \underline{A}_F .

7. Sample Trajectory

Figures 11 through 18 present a sample trajectory which could be used for a lunar landing. This trajectory is presented for illustration only and is not necessarily representative of any planned mission.

Note the irregularities in the curves of the attitude and gimbal angles. Steering commands produce these. Also note as the LEM approaches the end of the approach phase, the bank angle approaches zero, and therefore, the horizon approaches a horizontal attitude in the window.

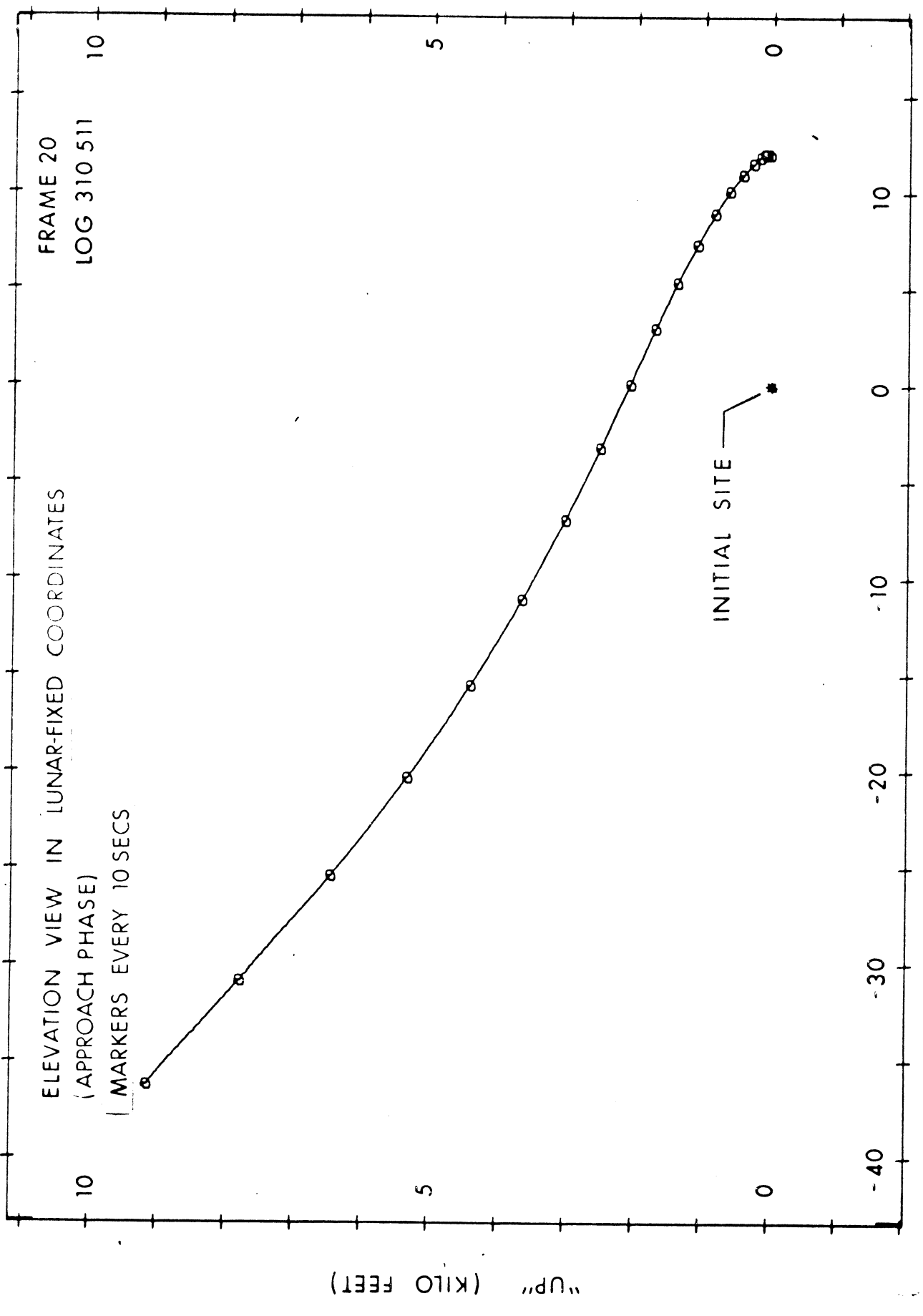

TP 13775-2

DOWN RANGE (KILO FEET)

C. ANAHEIM, CA

CHA

MADE IN U.S.A.

Figure 11

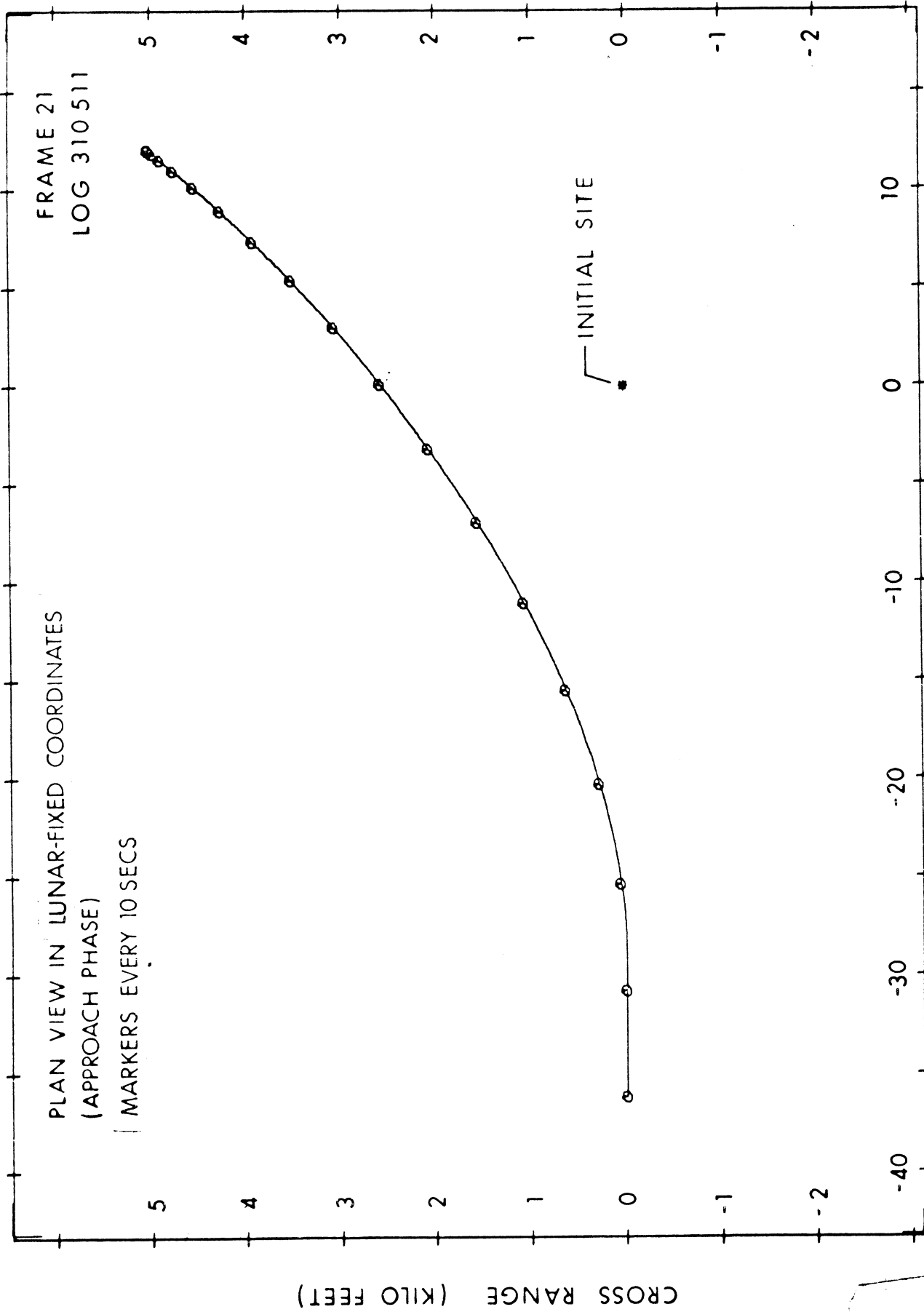

TP 13775-3

Figure 12

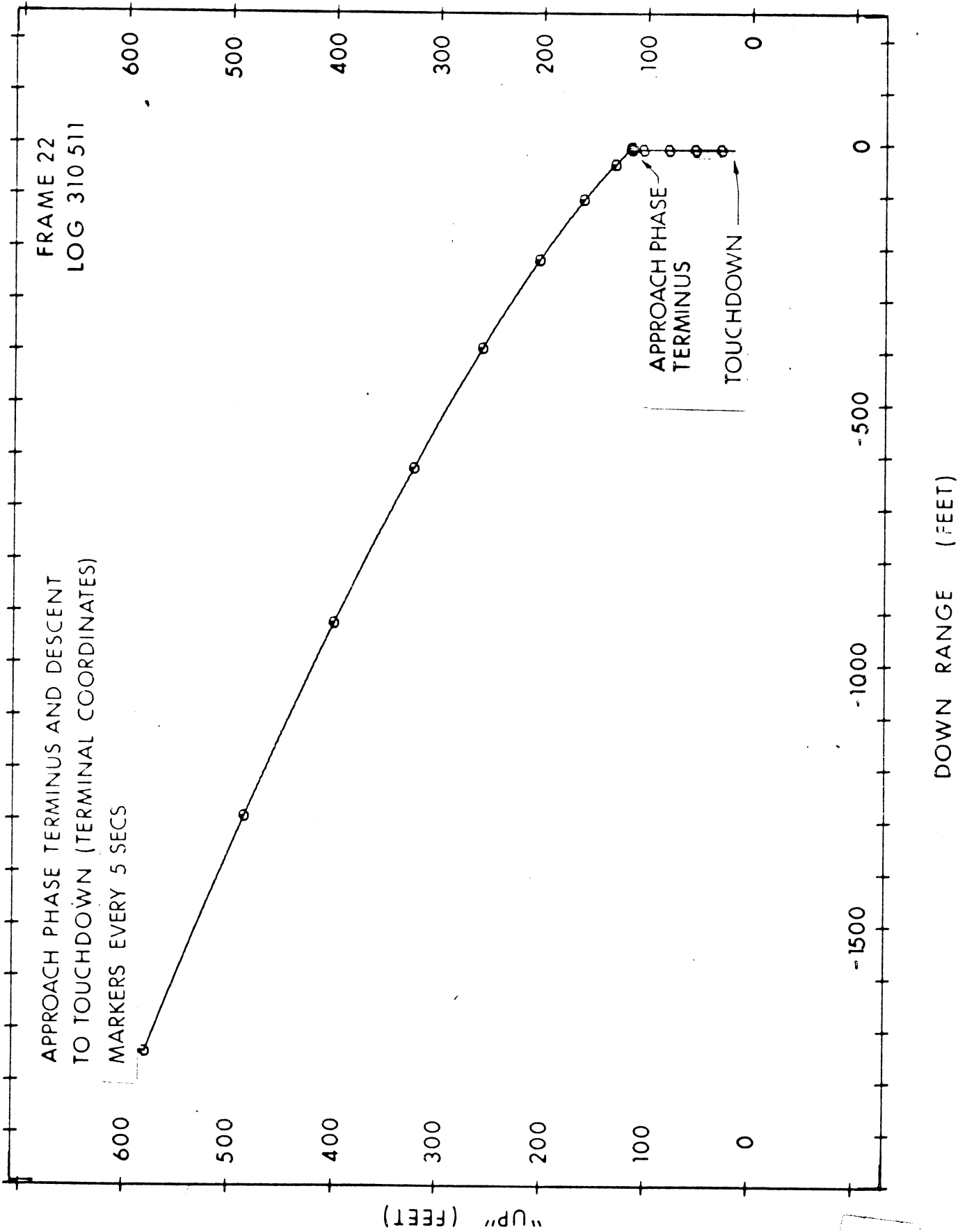

Figure 13

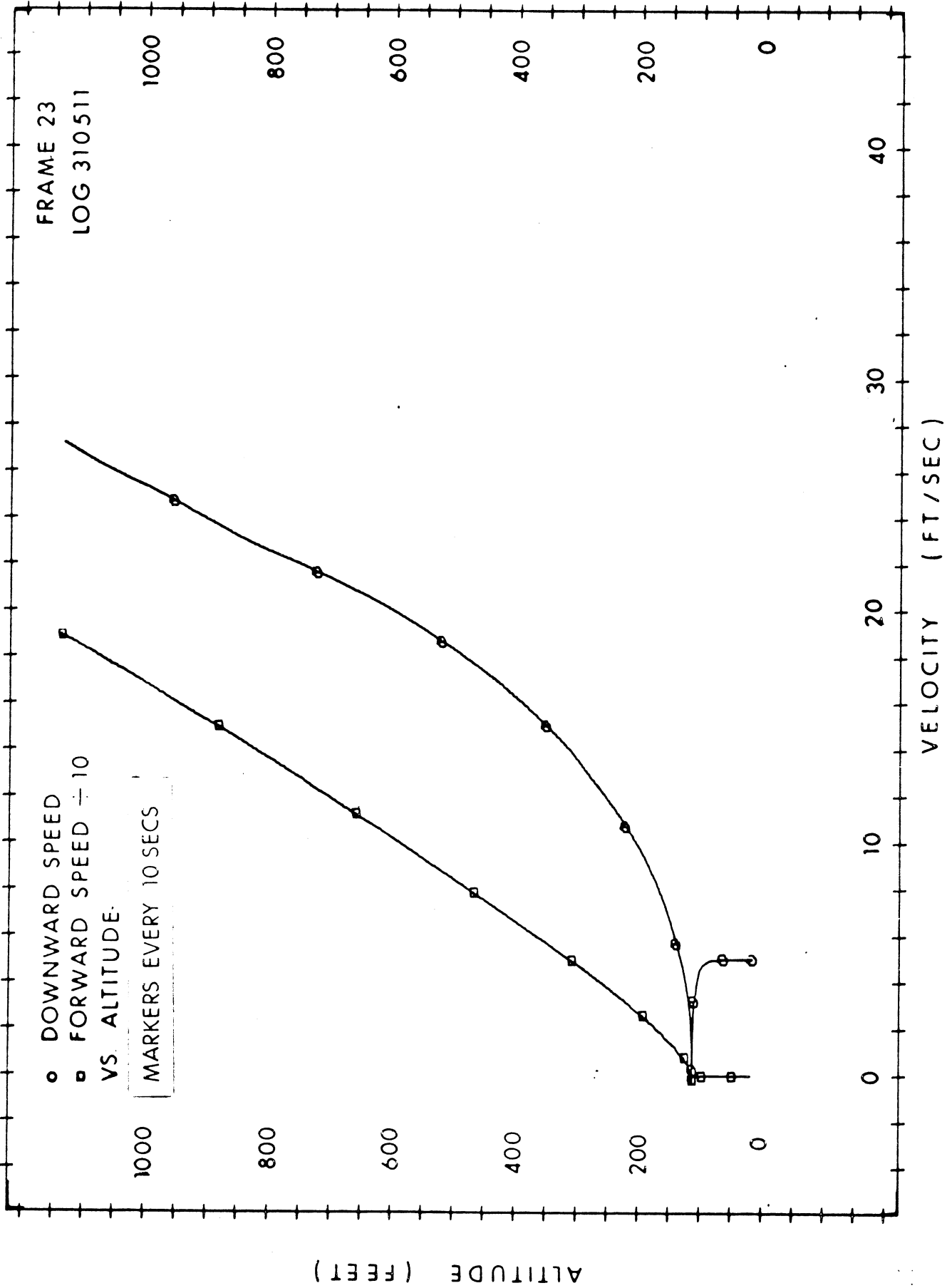

Figure 14

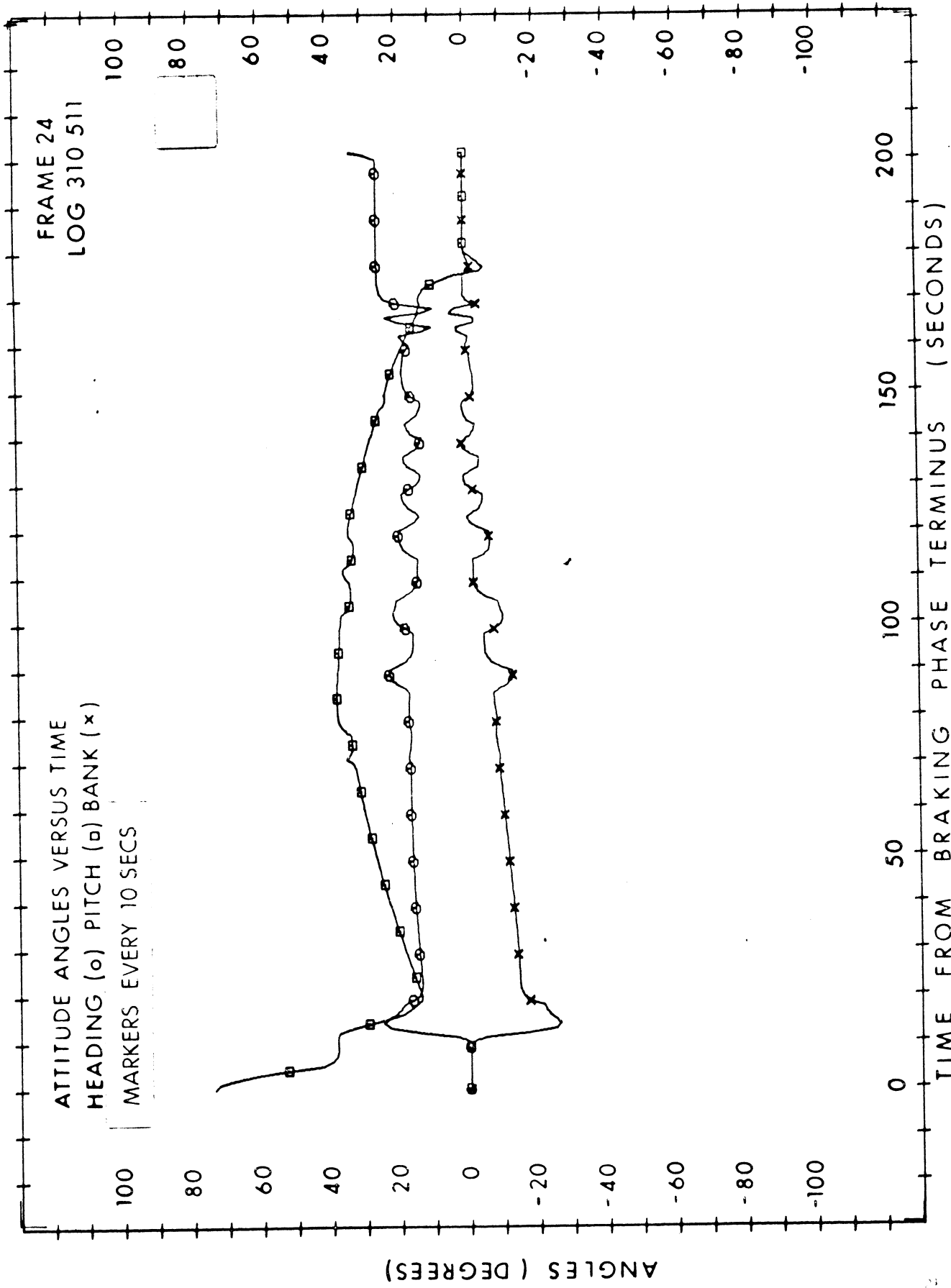

Figure 15

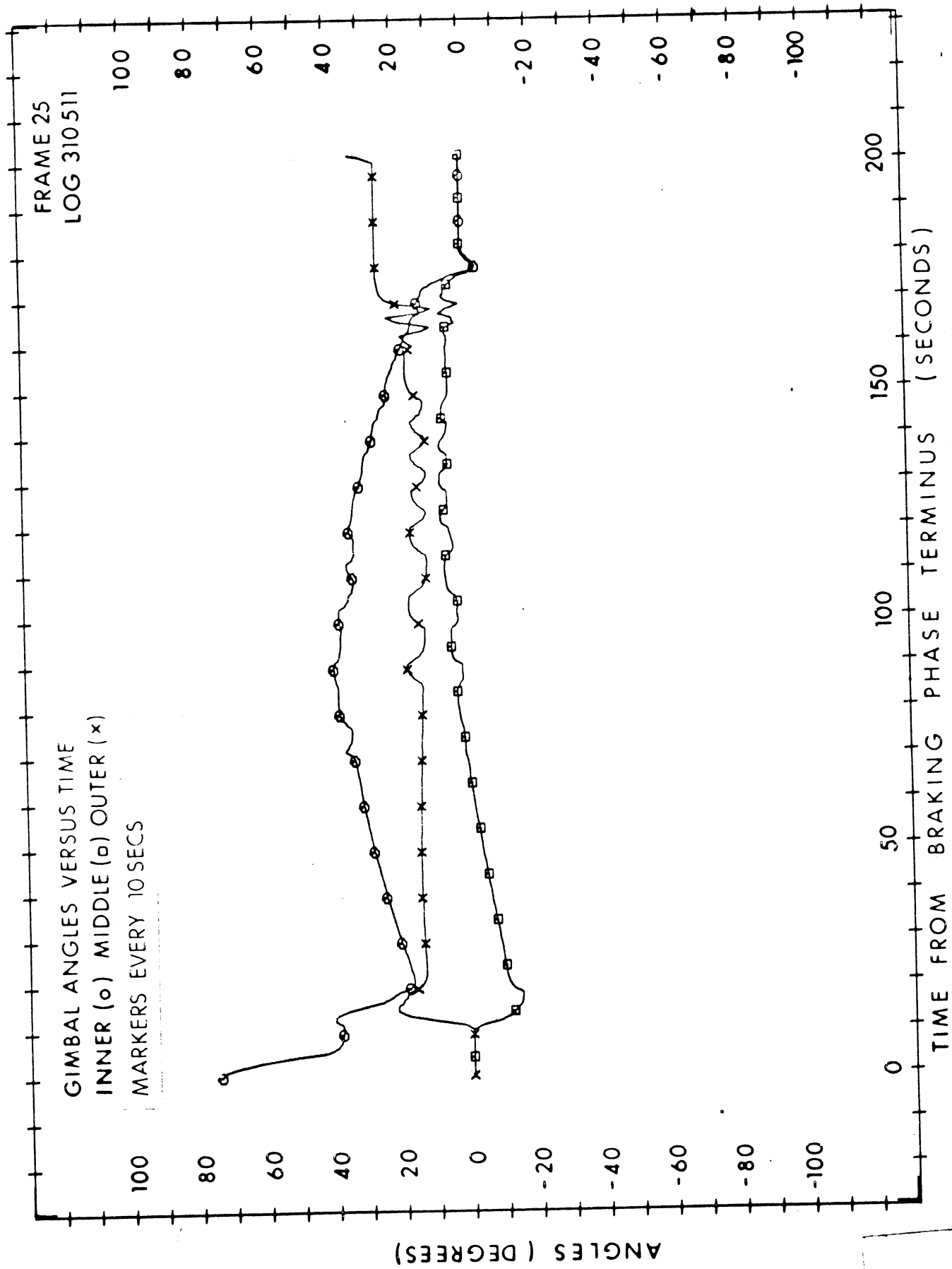

Figure 16

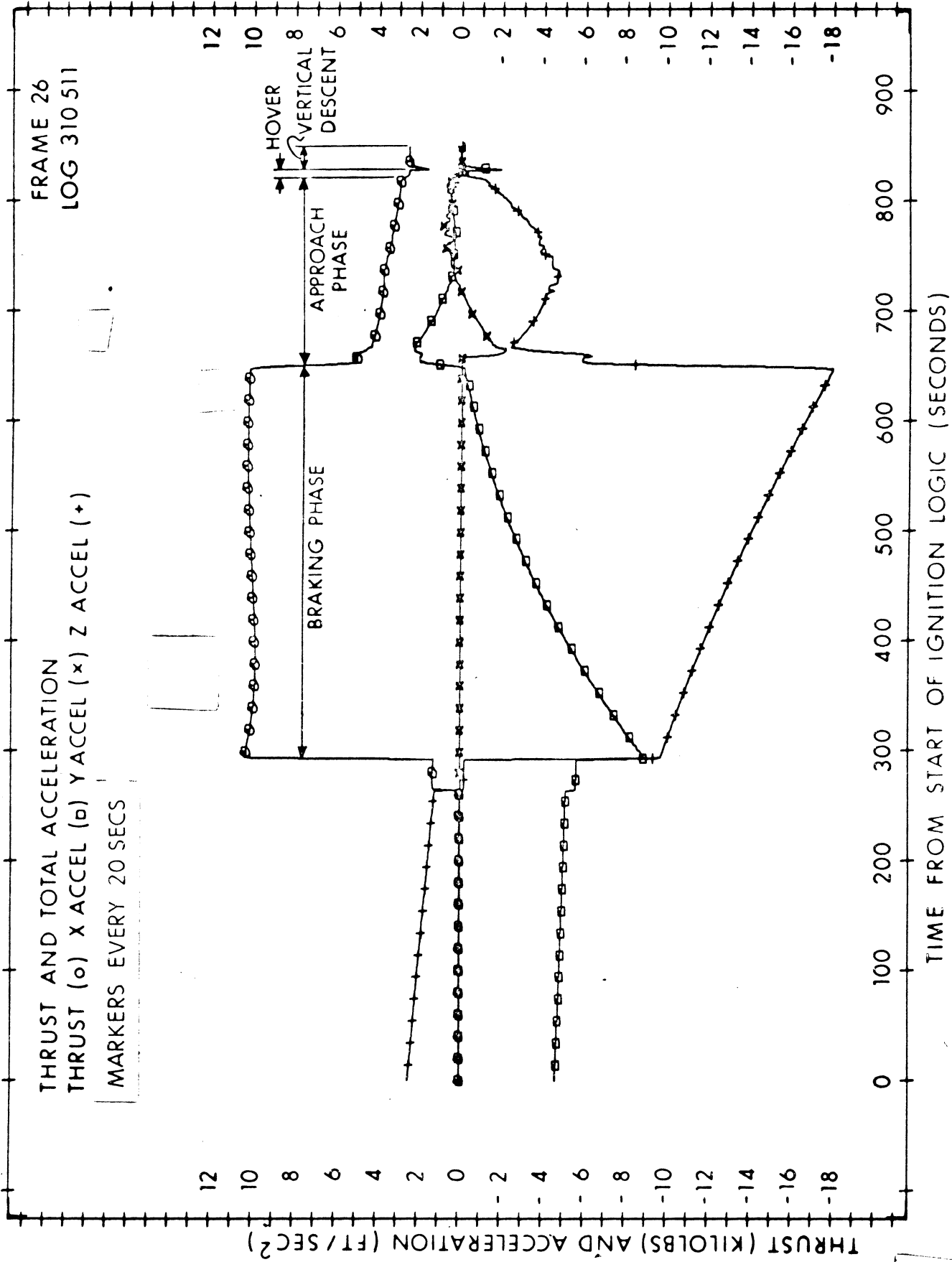

Figure 17

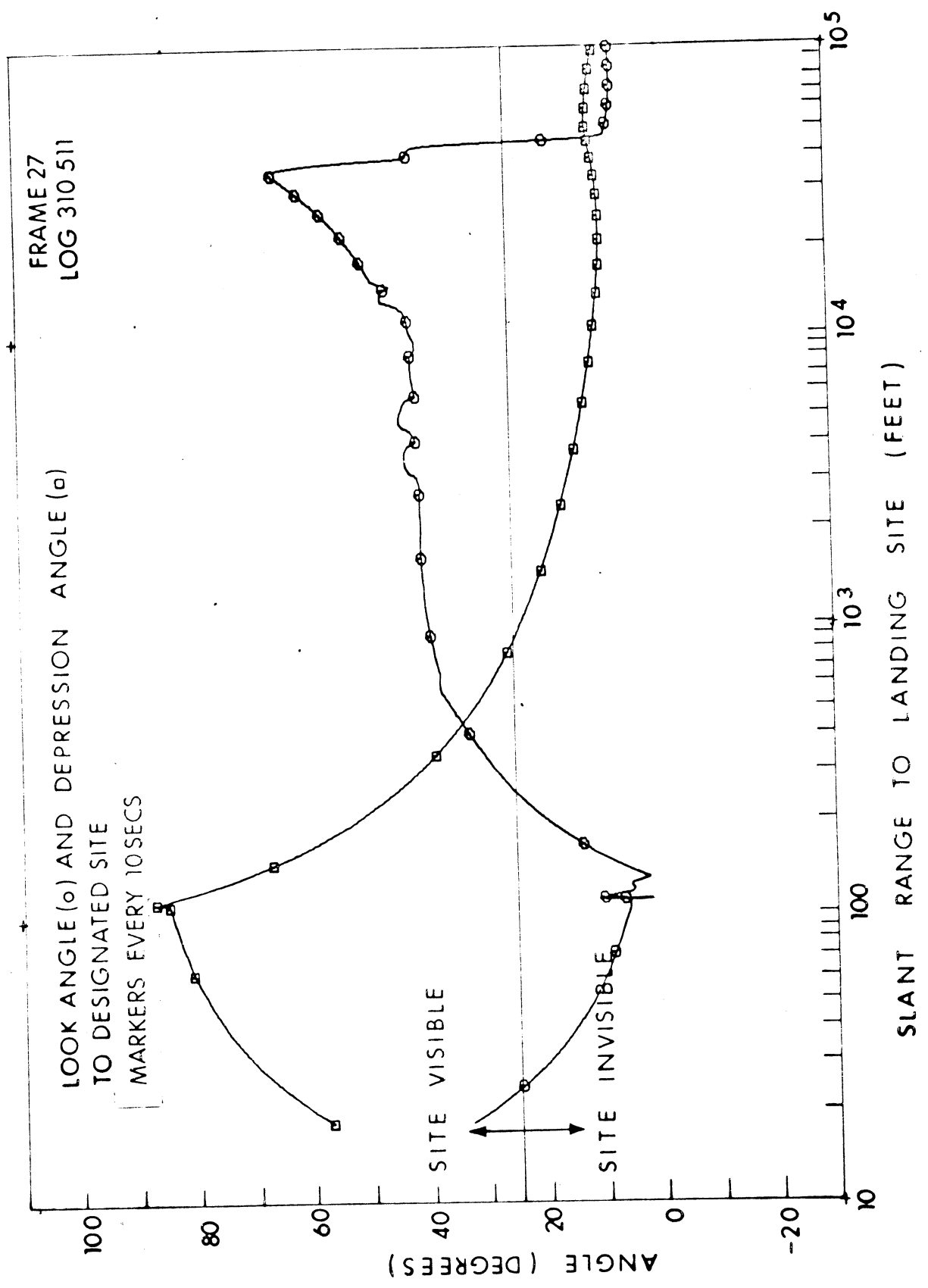

Figure 18

REFERENCE

1. Cherry, G., "E Guidance - A General Explicit, Optimizing Guidance Law for Rocket-Propelled Spacecraft" MIT Instrumentation Laboratory, R-456, August 8, 1964.