

UNDOCKING TO DPS PRESSURIZATION

96:00

PREP FOR UNDOCKING

USE ACTIVATION & C.O.
 C/L TO 10 MIN BEFORE UNDOCK
 CHECK ATT (0, 224, 060)
 V48 22012
 LM WT _____ (36,693)
 PRO, V34
 V06N20 COPY LM AND CSM ANGLES AND TIME
 P47

UNDOCK & SEPARATION _____ : _____ : _____ (96:14)

V77E
 POO, V60 [TRIM TO -1 FPS]
 YAW LT 60°
 PITCH UP 90°
 *SEQUENCE CAMERA - ON (1 MIN) *
 FDAI (0, 013, 0)
 *VHF ANT - FWD *
 *SEQUENCE CAMERA - OFF *
 HELMETS & GLOVES - OFF (OPT)

 *SUIT GAS DIVERTER - EGRESS *
 *CABIN GAS RETURN - EGRESS *

 *S-BD ANT - AFT, VERIFY COMM *
 *S-BD P _____ (+63) *
 * Y _____ (-32) *
 *S-BD ANT - SLEW (>3.0) *
 *TRACK MODE - AUTO *
 *VHF B XMTR - OFF *
 *BIOMED - LEFT, PCM - HI *

 *UPLINK SQUELCH - OFF *
 VOICE N20 ANGLES AND TIME TO MSFN
 CAMERA SETTINGS FOR CABIN PHOTOS
 LM/DAC/10/CEX (T/1.8, 1/60, 2ft)
 * 6 FPS, .125 MAG N, (2 MIN) *
 *LM/DC/60/HCEX (f5.6, 1/2 - 1/8, *
 * FOCUS) 5 FR, MAG-A *

AOS
 96
 +16

96:20

96:20

DPS THROTTLE CHECK

*CB(16) STAB/CONT: ENG ARM - CLOSE *
 THROT CONT - MAN/CDR
 TTCA (BOTH) - THROTTLE (MIN)
 *VERIFY MSFN CONTACT *
 ENG STOP - PUSH
 ENG ARM - DES (DES REG LT - ON)
 TTCA MIN (6.6% - 13.4%)
 THEN SOFT STOP (46.2% - 59.2%)
 THEN MAX (93.6% - 100+%)
 THEN MIN
 ADJUST FRICTION
 MAN THROT - LMP
 *REPEAT TEST FOR LMP TTCA *
 ENG ARM - OFF
 *CYCLE CWEA (DES REG LT - OFF) *
 ENG STOP - RESET
 THROT CONT - AUTO/CDR
 TTCA (BOTH) - JETS

168T

DPS PRESS & C.O.

PRPLNT TEMP/PRESS MON - DES 1 & 2
 FUEL 50°-75°F 50-130 PSI
 OXID 50°-75°F 30-80 PSI
 HELIUM MON: SUPCRIT PRESS 1070-1570
 : AMB PRESS 1495-1750
 DES He REG 1 tb - GRAY, REG 2 tb - bp
 MASTER ARM - ON
 DES PRPLNT ISOL VLV - FIRE
 He PRESS/DES START - FIRE
 MASTER ARM - OFF
 PRPLNT TEMP/PRESS MON: DES 1 & 2
 FUEL & OXID 50°-90°F 200-250 PSI
 HELIUM MON: AMB PRESS 200-1110
 : SUPCRIT PRESS 1070-1570

96:25

96:25

AGS ACTIVATION TO LR CHECKOUT

AGS ACTIVATION

*AGS STATUS - STBY (MASTER ALARM, *
 * & AGS WARNING LT - ON) *
 *CB(16) STAB/CONT: AEA - CLOSE *
 * (AGS WARNING LT - OFF) *
 CB(11) AC BUS B: AGS - CLOSE *
 *RECORD TIME _____:_____ *
 *AGS STATUS - OPERATE (MASTER ALARM, *
 * & AGS WARNING LT - ON) *
 *02/H20 QTY MON - C/W RESET *
 *ATT MON (LMP) - AGS *
 *V16 N65E *
 *SET AGS TIME USING 90 HR BIAS *
 * 377 _____ (+03850) *
 *616+0 *
 *224 _____ (+60514) *
 *225 _____ (+29419) *
 *226 _____ (+60384) *
 *305 _____ (+00563) *
 *662 _____ (-33024) *
 *673 _____ (-54517) *
 *412R+1 SELF TEST SATISFACTORY *
 * +3 LOGIC TEST FAILURE *
 * +4 MEMORY TEST FAILURE *
 * +7 LOGIC & MEMORY TEST FAILURE *
 *574R DESCENT STAGE (+ NOT STAGED) *
 *604R LUNAR SURFACE FLAG *
 * (+ NOT ON LUNAR SURFACE) *
 *612R STAGING COUNTER (+0 NOM) *

96:30

96:30

*232R +00600 *
 *233R +00250 *
 *464R +00500 *
 *465R +00195 *
 *623R +00000 *
 *514R +00000 *
 *515R +40000 *
 *516R +00000 *
 *000 +888888 (OPR ERR LT - ON) *
 *123 -45679 (DO NOT ENTR) *

MSFN UPDATE

*COPY AGS K FACTOR _____:_____:_____ *
 *V47E *
 *V25E LOAD AGS K FACTOR UPDATE *
 *414+1 *
 *400+3 (AFTER 50 16) *
 *V83, 317R, 440R, SET ORDEAL *

LANDING RADAR CHECKOUT

CB(11) PGNS: LDG RDR - CLOSE *
 .CK TEMP (60° - 95°) *
 X-PNTRS - HI MULT *

MODE SEL - LR *
 TM SW - H/H *
 LDG ANT - AUTO *
 RDR TEST - LDG *
 POWER SIGNAL LIGHT OUT *
 TEST MON - ALT/VEL XMTR (2.1 - 5.0), AGC *
 X-PNTRS PEGGED UP, LT. *
 TM - H (8000 ± 100), H (-480 ± 2) *
 V63 N12 OPT 2, PRO *
 N66 8286 ± 10, ANT POS 1 (00001), PRO *
 N67 V_x (-00495 ± 2), V_y (+01862 ± 2), *
 V_z (+01331 ± 2) *
 V34, RDR TEST OFF (ALT - 0, POWER SIGNAL *
 LIGHT ON, X-PNTRS - CENTERED) *
 CB(11) PGNS: LDG RDR - OPEN *

96:35

LB-92

AGS CHECK TO MSFN UPLINK

96:35

AGS CONT CHECK

MODE CONT (AGS) - ATT HOLD *
 GUID CONT - AGS *
 MNVR TO FDAI (0, 330, 0) *
 *CAMERA SETTINGS FOR REV 12 TCA *
 *LM3/DAC/10/CEX (T/2.8, 1/250, ∞) *
 * 1 FPS, .05 MAG N, (5 MIN) *
 *LM/DC/60/HCEX (F5.6, 1/125, ∞) *
 * 5 FR, MAG A *
 *SEQUENCE CAMERA - ON (96:41) *
 REV 12 LS TCA _____:_____ (96:46) *
 *SEQUENCE CAMERA - OFF *

RENDEZVOUS RADAR CHECKOUT

GUID CONT - PGNS *
 CB(11) AC BUS A: RNDZ RDR - CLOSE *
 CB(11) PGNS: RNDZ RDR - CLOSE *
 *VHF A XMTR - VOICE/RNG *
 ✓ TEMP (10° - 75°) *
 RT/ERR MON - RR *
 RR SLEW, MANUAL LOCK-ON, RR LGC *
 TM - RNG/RNG RT *
 V63, PRO, NO TRACK LIGHT OUT, PRO, N78 *
 COMPARE N78, VHF, TM *
 V34 *
 *VHF A XMTR - VOICE *
 V41N72E (+00000 TRUN, +28300 SHFT) *
 CB(11) PGNS: RNDZ RDR - OPEN *
 CB(11) AC BUS A: RNDZ RDR - OPEN *
 V44, RR - SLEW *
 RT/ERR MON - LDG RDR/CMPTR *
 TM - H/H *

96:50

96:50

MSFN UPDATE

*COPY CSM CIRC P76 *
 *SET DET TO COUNT DN TO CSM CIRC *
 *COPY PADS FOR *
 * NO PDI + 12 ABORT *
 * PDI *
 * PDI EARLY ABORT *
 * PDI LATE ABORT *
 * T2 ABORT *
 * T3 TIG *

IMU FINE ALIGN

V76 *
 P52 OPT 3 *
 CB(11) AC BUS B: AOT LAMP - CLOSE *
 AOT - DETENT F/0.0° *
 PGNS MODE CONT - AUTO *
 1ST STAR SPICA (226) *
 PRO *
 2ND STAR ANTARES (233) *
 N05 ANGLE DIFF _____ *
 PRO *
 N93 TORQUING ANG *
 X _____ *
 Y _____ *
 Z _____ *
 PRO, RCD GET _____:_____:_____ *
 N25, ENTR *
 POO *
 DETENT CL *
 CB AOT LAMP - OPEN *

MSFN UPLINK

*UPDATA LINK - DATA *
 *UPLINK CSM/LM S.V., E-MEMORY, *
 * DESCENT TARGETING *
 *UPDATA LINK - OFF *
 *V47, 414+1, 400+3 *
 *V83, 317R, 440R, SET ORDEAL *

97:05

LB-93

	R	R̂
MAX	4.27	7 FPS
N78		
VHF		
TM		

97:05

COAS CALIBRATION

P52
PGNS MODE CONT - AUTO
N70, ENTR 026 (SPICA), PRO
N87, (+00000, +00000) PRO, PRO

BIAS AZ _____
EL _____

LPD CALIBRATION

ENTR
N70, ENTR 026 (SPICA), PRO
N87, (+00000, +32046) PRO, PRO
P00

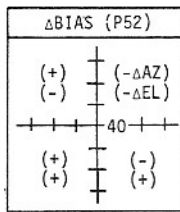

MSFN UPDATE

COPY AND LOAD GYRO DRIFT COMP, PIPA BIAS
(REF. P2 DATA CARD BOOK)

CONFIGURE COMM FOR LOS

*MATCH INDICATED ANGLES
*TRACK MODE - SLEW
*S-BD ANT - FWD
*SET P (- 2)
* Y (+41)
*VHF B XMTR - DATA, PCM - LO
*UPLINK SQUELCH - ENABLE

MNVR TO AGS CAL ATT

V49, +02250 OGA ROLL 24 }
+11250 IGA PITCH 122 } FDAI
+02250 MGA YAW 339 }

LOS
97
+22

97:25

97:25

AGS CALIBRATION

*READ AND RECORD INITIAL CAL.NOS. *
PGNS MODE CONT - ATT HOLD *
*VERIFY 25 MIN SINCE TURN-ON *
V60, V76, V16N20E *
RATES < 0.075°/SEC *
*400+6, START WATCH *
*400R *
MONITOR ICDU LIMITS *
{ OGA +00000 / +04500 } LIMITS *
{ IGA +09000 / +13500 } *
{ MGA +00000 / +04500 } *
*CHECK ECS, RCS, EPS, APS *
*CYCLE CWEA CB *
*400R+0 *
*READ AND RECORD CAL VALUES *

BEFORE LIMITS ARE EXCEEDED, 400+0.
IF TIME IS LESS THAN 5 MINUTES
REPEAT AGS CALIBRATION.

	INIT	CAL	Δ LIM
540	+2	-3	± .039
541	-1	+3	± .039
542	-2	+3	± .039
544	+6	-3	+2.00
545	-30	-6	+2.00
546	-47	-0	+2.00

CSM CIRCULARIZATION

P76 (UPDATE CSM S.V.), PRO (97:42)

V82, N12-00002, PRO
√CSM HA/HP

*PCM - HI *
*V47, 414+1 *
*V83, 317R, 440R *
*PCM - LO *

SR
97
+41

97:45

97:45

P63 IGNITION ALGORITHM TEST

P63
*RESET DET TO CONT DN TO PDI *
PGNS MODE CONT - AUTO *
N18 R, P, Y (0, 111, XXX) PRO *
YAW TO 340° *
P00 *
V48, 22112, 00011, PRO, V34 *

*CAMERA SETTING (PDI) *
*LM3/DAC/10/CEX-WDG (T/2.8, 1/500, ∞) *
* 12 FPS, .75 MAG N, (6 MIN) *
*CAMERA SETTING (EARTH RISE) *
*LM/DC/60/HCEX (f16, 1/250, ∞) *
* 5 FR, MAG A *

COAS TO OVERHEAD WINDOW
VERIFY LOOSE GEAR STOWED
RESTRAINTS ATTACHED
VERIFY FDAI'S INERTIAL

PRE-PDI ECS CHECKOUT

HELMETS AND GLOVES ON *
*CABIN REPRESS - CLOSE *
*SUIT GAS DIVERTER - EGRESS *
*CABIN GAS RETURN - EGRESS *
*PRESS REGS A&B - EGRESS *

PRE-PDI SWITCH SETTING CHECK

*VHF ANT - FWD *
CB(11)EPS: INV 1 - CLOSE *
*SELECT INV 1 *

98:00

98:00

CB(11) STAB/CONT: AELD - CLOSE
CB(11) STAB/CONT: ABORT STAGE - CLOSE
RESET ENG STOP PB
SET WINDOW BARS

*CB(16) STAB/CONT: AELD - CLOSE *
CB(16) STAB/CONT: ABORT STAGE - CLOSE

-30

*CYCLE CWEA CB *
*BATS 5 & 6 NORM FEED - ON *
*RECORD GET _____:_____:_____ *

THROT CONT - AUTO
CDR TTCA - THROTTLE - MIN
*LMP TTCA - THROTTLE - SOFT STOP
RATE SCALE - 25°/SEC
ATT/TRANSL - 4 JET
CHECK DPS, APS, RCS, ECS, EPS
CHECK SWITCH GUARDS
PRPLNT QTY MON - DES 1

AOS -25

*S-BD ANT - FWD, VERIFY COMM *
*√S-BD P (- 2) *
* Y (+41) *
*S-BD ANT - SLEW (>3.0) *
*TRACK MODE - AUTO *
*VHF B XMTR - OFF *
*BIOMED - LEFT, PCM - HI *
*UPLINK SQUELCH - OFF *
*VOICE AGS CAL. NOS. TO MSFN *
*CHECK ED BATTs AND REPORT *
*VOICE ASC BATT ON TIME TO MSFN *

+10

MSFN UPLINK, UPDATE

*UPDATE LINK - DATA *
UPLINK LM S.V., RLS *
*UPDATE LINK - VOICE BU *
*COPY, LOAD AGS RLS (231) *
*COPY, LOAD LPD BIAS *

√BURN ABORT RULES

98:20

AGS INITIALIZE TO PDI

98:20

AGS INITIALIZE

```

-15      *V47, 414+1
          *V83, 317R, 440R
          *240 + (231 RLS PAD)
          *254+05390
          *262-00150

          MODE SEL - AGS

POWERED DESCENT INITIATION
-10      V25 N69E (IF NO UPLINK)
          PGNS MODE CONT - AUTO
          AGS MODE CONT - AUTO
          P63
          AUDIO MODE (BOTH) - VOX

          ✓DPS CONFIG CARD
          *RESET DET
-8        N18, R, P, Y (0, 111, 340)
          VERIFY FDAI
          *V40N20E, 400+3, 410+0
          *400+1, 433R VI
-5        CB(11) PGNS: LDG RDR - CLOSE
          ✓ALT XMTR
          PRO - FINAL TRIM
          ENTR, ✓DET
          GO/NO-GO FOR PDI
          COMM CHECK WITH CSM
          RESET WATCH
-2:00    MASTER ARM - ON
          MODE SEL - PGNS
          *367R
-0:30    ENG ARM - DES
-0:07.5  ULLAGE
-0:05    PRO
0:00    PDI : : (98:34:41)
+0:02    (NO IGN) - START PB - PUSH
+0:05    DES ENG CMD OVRD - ON
          MASTER ARM - OFF
    
```

GO-AROUND

```

SECURE SYSTEMS
ENG ARM - OFF
MASTER ARM - OFF
POO
LR - OFF
ASC BATTs - OFF
PRLPNT QTY MON - OFF
AUDIO - PTT
ECS - CABIN MODE
HELMETS & GLOVES - OFF (OPTIONAL)
AGS - ATT HOLD

ALIGN IMU
P52 (SAME STARS)

MSFN UPDATE
COPY PADS FOR:
NO PDI + 12
PDI
PDI EARLY ABORT
PDI LATE ABORT
T2 ABORT
T3 TIG
AGS ABORT CONSTANTS
224,225,226,305,662,673
AGS T2 UPDATE - 254

MSFN UPLINK
DESCENT TARGETING, ABORT CONSTANTS,
LM & CSM S.V.

CONFIGURE COMM FOR LOS

PICK UP WITH P63 IGNITION ALGORITHM TEST, P.5
    
```

86-8T

PDI THRU TD+3 MIN

```

-2:00 MASTER ARM-ON
      MODE SEL-PGNS
      367R
- :30  ENG ARM-DES
- :07.5 ULLAGE
- :05  PRO
+ :00  PDI
+ :02  (NO IGN) ---
      START PB-PUSH
+ :05  DES ENG OVRD-ON
      MASTER ARM-OFF
+ :26  THROTTLE UP
      ✓T/W > 1.6

+2 V21 N69E (DN RNG)
+3 YAW FACE UP
+4 ✓ ED BATTs
      V57E TO PERMIT
      LR DATA
+5 V24 N69E (DN RNG,
      X-RNG)

N68
EVAL MAN CONT
+8 V23 N69E (ALT)
223+00140 (E @ 14K)
360-0XXX0E
SEQ CAMERA - ON
    
```

TFI	θ	ΔHMAX	(-HMAX) -HDOT	H	DPS	SBD
0:00	111		5.0	52700	95	-2/41
0:30	111		7.0	52600	95	
1:00	103		25.0	52100	95	5/36
1:30	97		36.0	51100	92	
2:00	93		45.0	49900	87	13/29
2:30	89		51.0	48500	82	
3:00	85		57.0	46800	77	19/23
3:30	82		62.0	45100	71	
4:00	79		67.0	43100	66	8/5
4:30	77		73.0	40400	61	
5:00	75	+17000	78.0	39000	56	11/2
5:30	74	+17000	89.0	36600	50	
6:00	72	+16000	99.0	32800	45	13/0
6:30	71	+14000	(511.0) 107.0	30000	40	
7:00	67	+12400	(481.0) 104.0	26900	35	17/-3
7:30	62	+10000	(447.0) 103.0	23500	30	
8:00	59	+ 8200	(410.0) 130.0	20000	27	23/-8
8:30	59	+ 6900	(368.0) 155.0	16400	24	
9:00	55	+ 4500	(298.0) 172.0	11300	21	26/-11

P64

P64 + 15 SEC:
NO THROTTLE DN
- ABORT

H	(-HMAX) -HDOT	DPS	VH (362)
7000	(226.0) 176.0	18	254
6000	(207.0) 159.0	18	234
5000	(185.0) 137.0	17	219
4000	(162.0) 115.0	16	200
3000	(135.0) 92.0	15	176
2000	(104.0) 66.0	14	144
1000	(63.0) 36.0	13	96
500	(35.0) 17.0	11	53
400	(28.0) 12.0	11	39
300	(21.0) 8.0	10	19
200	(12.0) 5.0	9	-6

MODE CONT (PGNS)-ATT HOLD

P66

X-PNTR - LO MULT

BINGO FUEL
DES QTY LT+T+31

TOUCHDOWN

ENG STOP - PUSH
ENG ARM - OFF
PRO
DES ENG CMD OVRD - OFF
MODE CONT (PGNS)-ATT HLD
MODE CONT (AGS)-AUTO
413+1
RECYCLE PARKER VALVES

ABORT STAGE - PUSH
ENG ARM - ASC
ENG STOP - RESET
ENG START - PUSH
V22 N46 E,E
MODE CONT (BOTH) - AUTO

LB-9T

TD +3 THRU T2 ABORT

N76 5510.6 V HORZ
 19.5 V VERT
 CROSS RNG (<8.1)
 N74 TFI, YAW, PITCH

*RECYCLE PARKER VALVES *
 PRPLNT TEMP PRESS MON - ASC, THEN DES *
 ASC He MON - CYCLE *
 *O2/H2O QTY MON - ASC 1, 2, THEN DES 2, 1 *
 *SEQUENCE CAMERA - OFF *
 CB(11) PGNS: LDG RDR - OPEN *

*IF AGS ALIGNMENT NO GO *
 *V47E, 414+1 *
 *V40N20E, 400+3 *

*410+0 *
 22:16 T2 STAY/NO STAY AND GO/NO-GO FOR
 DPS VENT

17:50 T1 STAY/NO STAY

NO STAY V22 N46 E,E
 MODE CONT (BOTH) - AUTO
 ABORT STAGE - PUSH
 ENG ARM - ASC
 ENG STOP - RESET
 ENG START - PUSH

STAY *414+2 *
 *400+4 *

P68
 ENG STOP-RESET
 PRO
 P12
 MODE CONT (PGNS) - AUTO
 N33 T-2 (98:58:57)

NO STAY
 -2:00 ASC He SEL - BOTH
 MASTER ARM - ON
 ASC He PRESS - FIRE
 ASC He REGS 1, 2 - OPEN
 *A ASC FEED 2-OPEN (UNLESS CDR) *
 *A MAIN SOV -CLOSE (BUSS LOSS) *
 *B ASC FEED 2-OPEN (UNLESS LMP) *
 *B MAIN SOV -CLOSE (BUSS LOSS) *
 *CRSFD - CLOSED *
 *BAT 1,3 - OFF *
 *BAT 2,4 - OFF *
 *CB(16) EPS:ASC ECA CONT-CLOSE *
 *DES BAT - DEADFACE *
 *SELECT ASC H2O TANK *
 *DES O2 - CLOSE *
 *ASC 1 O2 - OPEN *
 *DES H2O - CLOSE *
 *ASC H2O - OPEN *
 *400+1, 367R *
 - :10 ABORT STAGE - PUSH (AT T=0 FOR AGS)
 ENG ARM - ASC
 - :05 PRO
 :00 *DET - RESET, RELEASE *
 T2 : : (98:58:57)
 + :01 ENG START - PUSH (IF AUTO IGN) *

STAY *TAPE RECORDER - OFF *
 AUDIO MODE - ICS/PTT
 POO

FDAI AND OVERHEAD WINDOW ANGLES FOR MANUAL DESCENT ABORT

DPS/APS			
1:00	250/0	4:30	0/LV
2:26	SD(FDAI)	4:44	300/36
2:36	SD(OHW)	6:26	270/5
		7:32	250/0
		8:19	SD
1:30	0/0	5:00	0/LV
1:44	300/0	5:14	300/36
2:30	250/0	6:58	270/5
3:20	SD	8:20	250/0
		9:03	SD
2:00	0/LV	5:30	0/LV
2:14	300/36	5:44	300/36
3:00	300/0	7:34	270/10
3:18	250/0	9:04	250/0
4:16	SD	9:46	SD
2:30	0/LV	6:00	0/LV
2:44	300/36	6:14	300/36
3:46	300/0	8:04	270/11
4:02	250/0	9:50	250/0
5:12	SD	10:39	SD
3:00	0/LV	6:30	0/LV
3:14	300/36	6:44	300/36
4:34	270/0	8:34	270/11
5:10	250/0	11:04	250/0
5:57	SD(FDAI)	11:47	SD
6:06	SD(OHW)		
3:30	0/LV	7:00	0/LV
3:44	300/36	7:14	300/36
5:24	270/0	9:06	270/14
5:54	250/0	12:26	250/0
6:50	SD(FDAI)	12:53	SD
7:02	SD(OHW)		
4:00	0/LV	7:30	0/LV
4:14	300/36	7:44	300/36
5:56	270/0	9:38	270/14
6:38	250/0	13:38	250/0
7:34	SD(FDAI)	13:53	SD
7:40	SD(OHW)		

ALL PITCH RATES
 5°/SEC

APS			
1:00	250/0	4:30	0/LV
2:24	SD/(FDAI)	5:10	300/36
2:36	SD(OHW)	6:22	270/10
		8:26	250/0
		8:51	SD
1:30	0/LV	5:00	0/LV
2:10	250/0	5:40	300/36
3:32	SD(FDAI)	7:08	270/10
3:52	SD(OHW)	9:20	250/0
		9:46	SD
2:00	0/LV	5:30	0/LV
2:40	300/0	6:10	300/36
3:10	250/0	7:54	270/12
4:24	SD(FDAI)	10:14	250/0
4:34	SD(OHW)	10:42	SD
2:30	0/LV	6:00	0/LV
3:10	300/0	6:40	300/36
4:00	250/0	8:44	270/14
5:18	SD	11:08	250/0
		11:37	SD
3:00	0/LV	6:30	0/LV
3:40	300/36	7:10	300/36
4:22	270/0	9:34	270/14
5:28	250/0	12:02	250/0
6:09	SD	12:33	SD
3:30	0/LV	7:00	0/LV
4:10	300/36	7:40	300/36
5:00	270/5	10:24	270/14
6:30	250/0	12:56	250/0
7:02	SD	13:28	SD
4:00	0/LV	7:30	0/LV
4:40	300/36	8:10	300/36
5:40	270/5	11:12	270/14
7:28	250/0	13:48	250/0
7:56	SD	14:19	SD

* ESTABLISH POSITIVE
 HDOT, THEN ABORT
 STAGE TO USE
 MANUAL ASCENT ANGLES

*
 USE
 MANUAL
 ASCENT
 ANGLES

88-81

88-81

LM LANDING DISPLAYS
P63, P64, P66

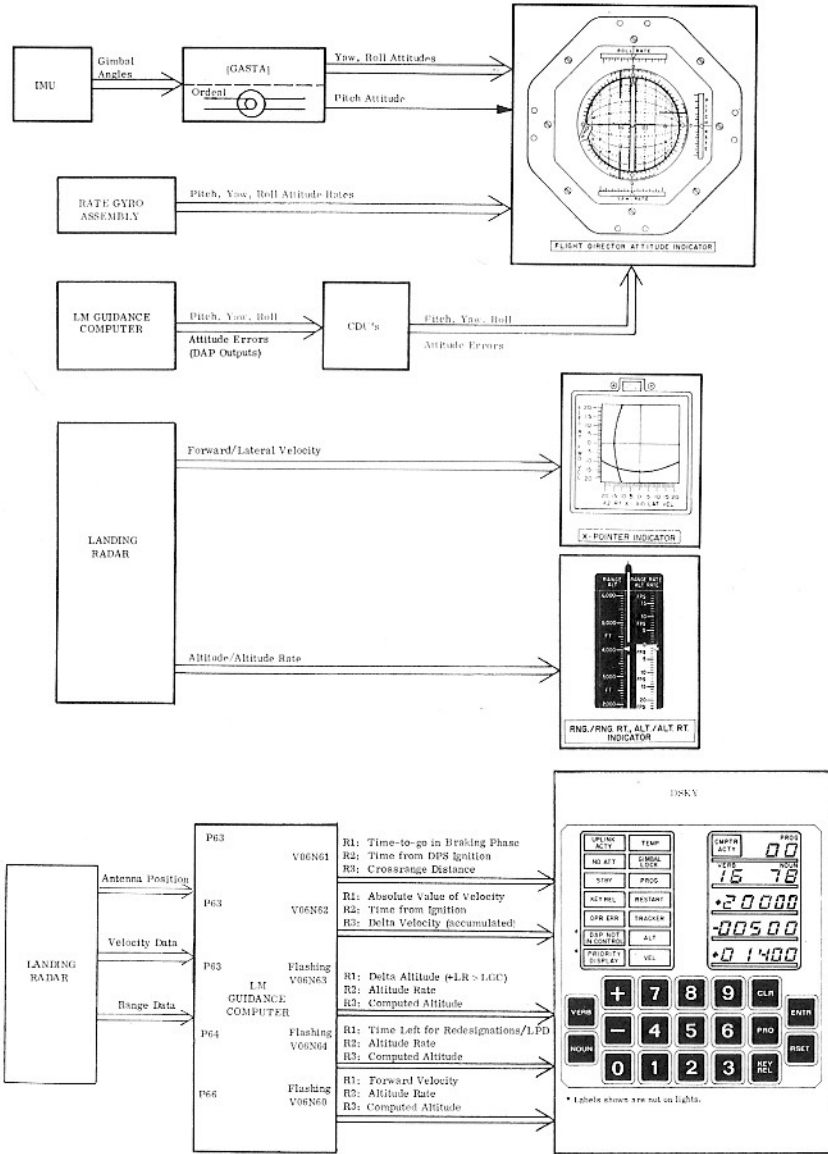

DESCENT DISPLAYS

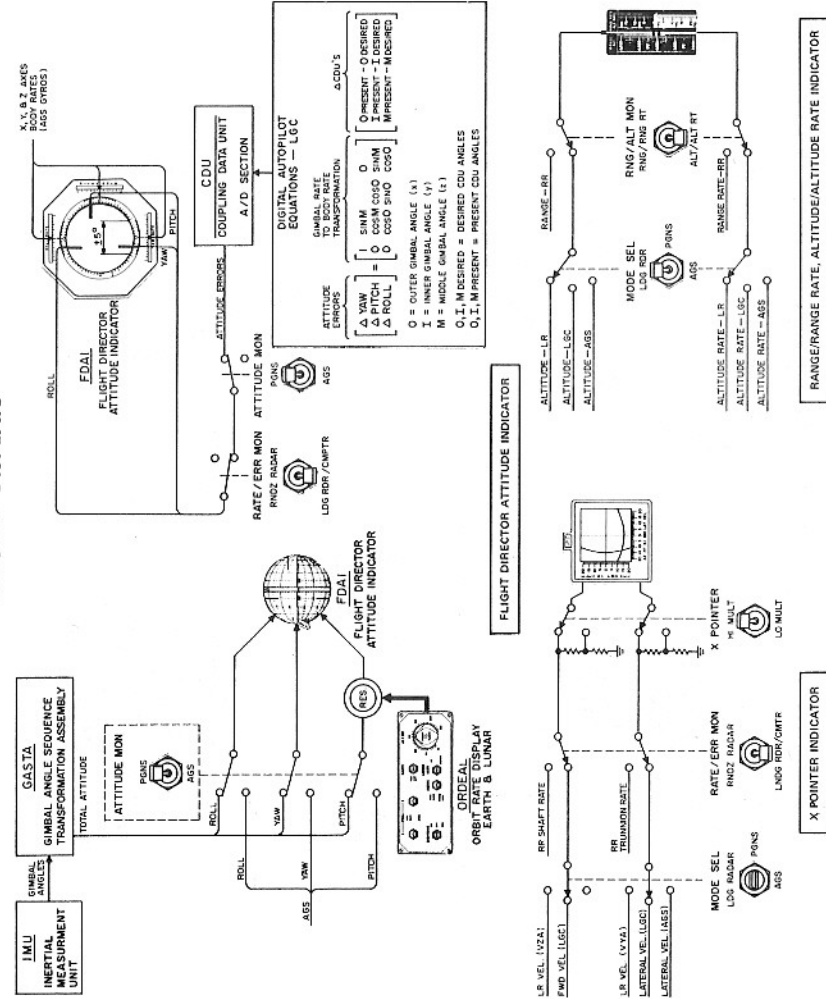

LANDING SITE REDESIGNATION (P64 ONLY)

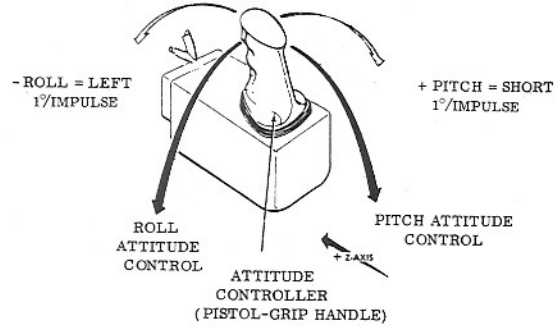
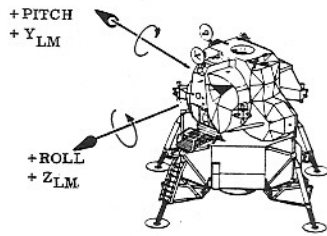
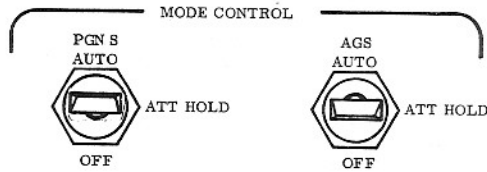
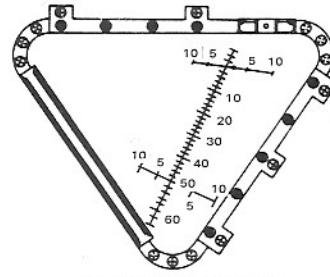

LB-102

LANDING PHASE MODE CONTROL
P66



RATE OF DESCENT
(ROD)

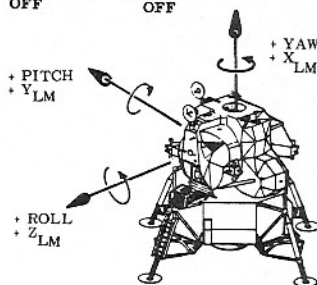
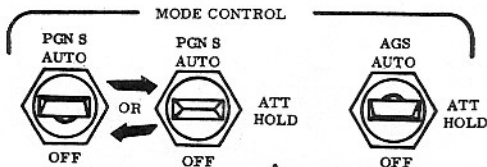
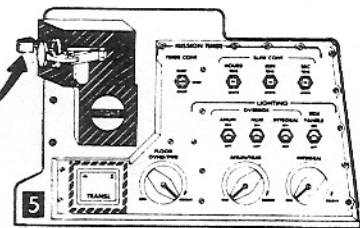
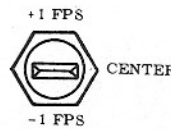

MANUAL LM ATTITUDE CONTROLLER

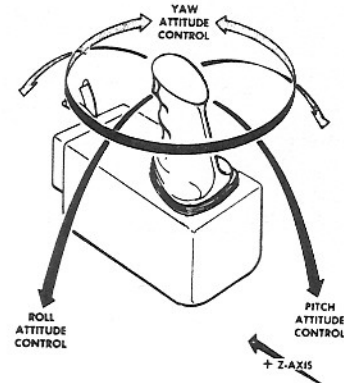

LB-103

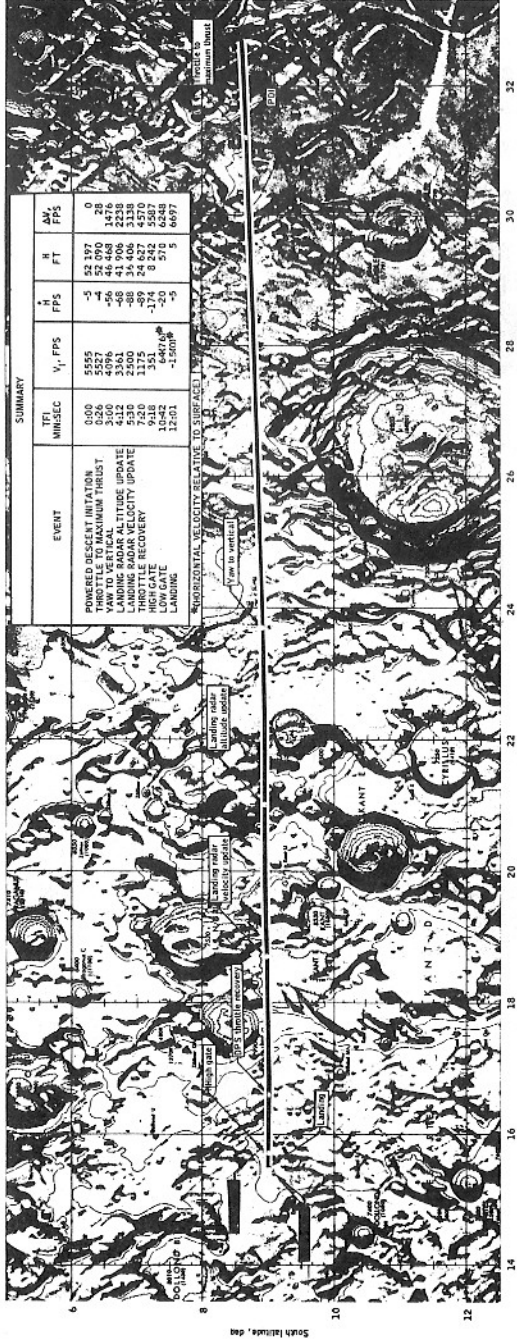

APOLLO 16 LM POWERED DESCENT GROUNDTRACK

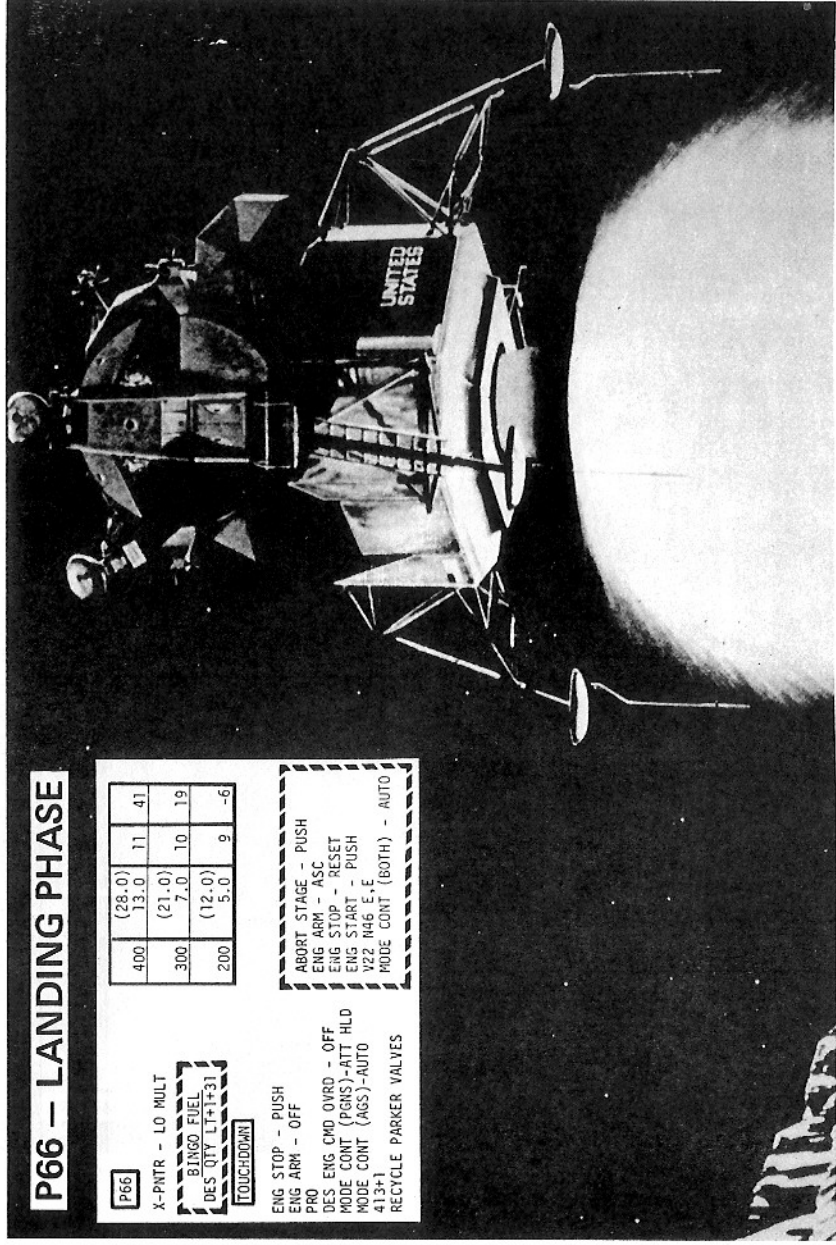

P66 - LANDING PHASE

P66

X-PNTR - LO MULT

BINGO FUEL
DES (TY LT+31)

TOUCHDOWN

ENG STOP - PUSH
ENG ARM - OFF
PRO
DES ENG CMD OVRD - OFF
MODE CONT (PGNS)-ATT HLD
MODE CONT (AGS)-AUTO
413+1
RECYCLE PARKER VALVES

400	(28.0)	13.0	11	41
300	(21.0)	7.0	10	19
200	(12.0)	5.0	9	-6

ABORT STAGE - PUSH
ENG ARM - ASC
ENG STOP - RESET
ENG START - PUSH
V22 M46 E
MODE CONT (BOTH) - AUTO

DESCARTES LRV TRAVERSES

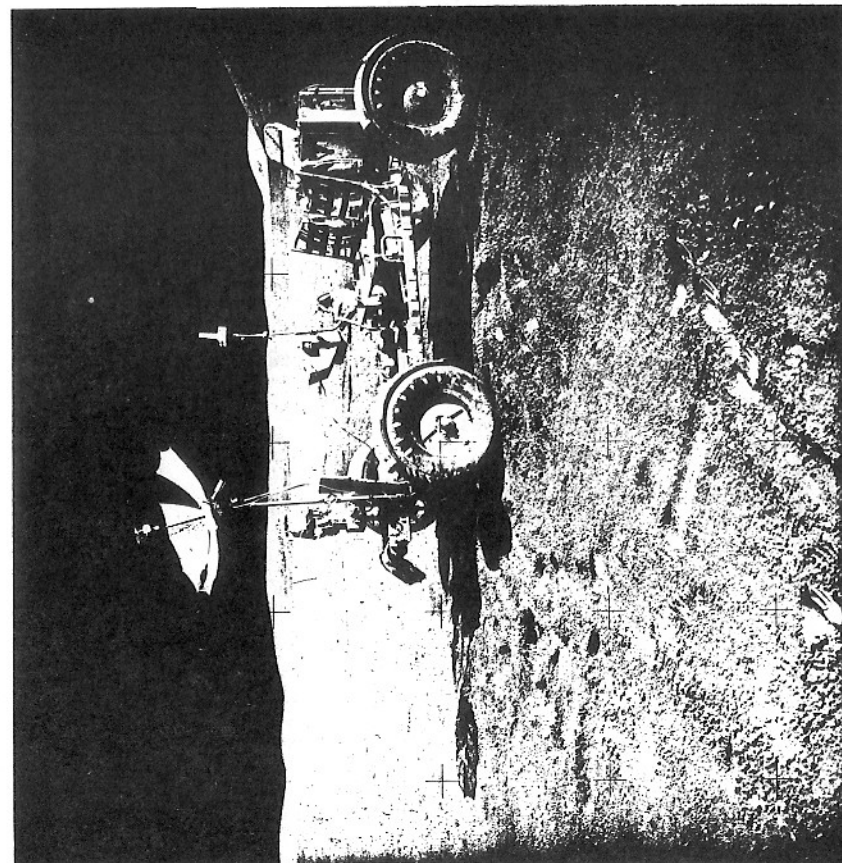
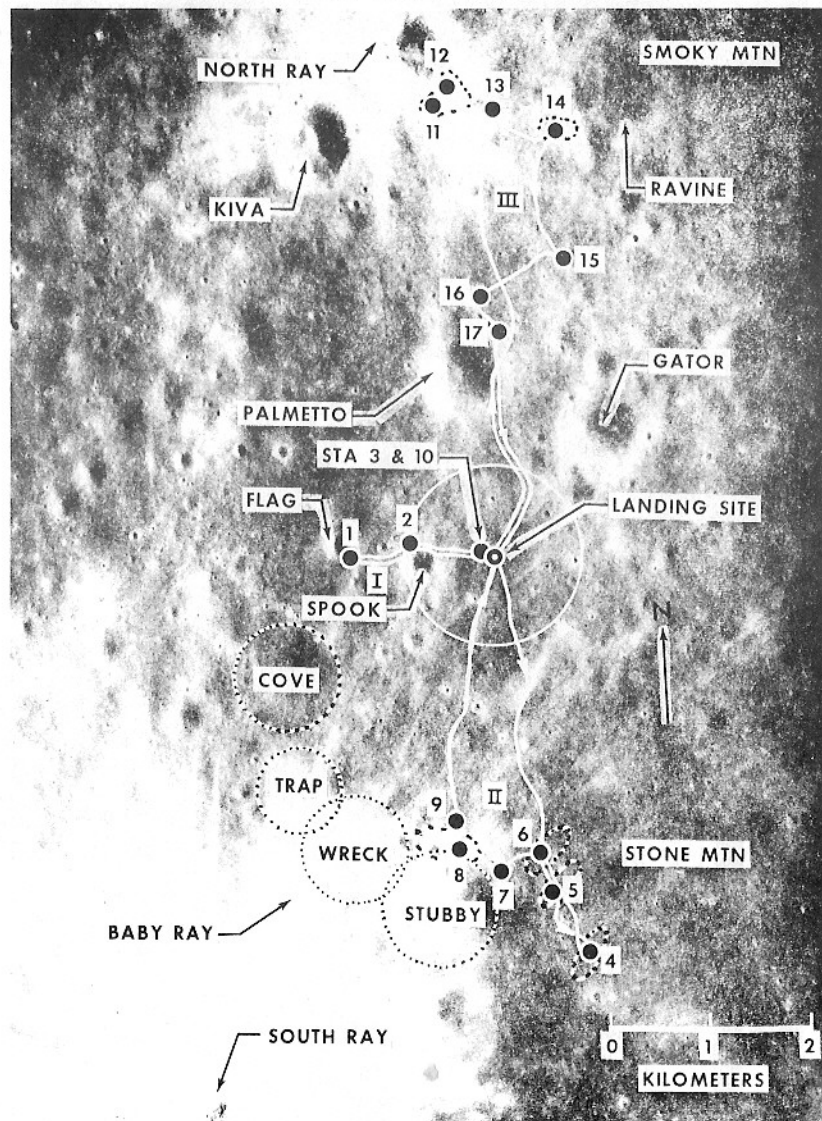

1st P57

P57E, R2 00003
 N06 00010
 00003
 00110
 PRO
 (No Att light-On/Off, Twice)
 N04 + _____ Navigation Error (0.01°)
 V32E
 (No Att light-On/Off, Twice)
 N04 _____ Gravity Error (0.01°)
 PRO
 N22 ICDU Angles
 PRO
 (No Att light-On/Off)
 N70 100 (Rigil Kent) 54
 PRO
 N88 -0.37780 X
 -0.31056 Y
 -0.87225 Z
 PRO
 N71 Star, 4 Marks
 N88 Verify Vector
 PRO
 N05 _____ Angle Difference (0.01°)
 PRO
 N93 _____ X Torquing Angles (0.01°)
 _____ Y
 _____ Z
 PRO
 N25 00014, Enter, 00E

2nd P57

P57, Set R2 00004
 N34 Load LO Time, PRO
 N06 00010
 00003
 00010
 PRO
 (No Att light - On/Off, Twice)
 N04 + _____ Gravity Error (0.01°)
 V32E (Recycle)
 N04 + _____ Gravity Error (0.01°)
 PRO
 N22 ICDU Angles
 PRO (No Att light - On/Off)
 N70/71 _____ STAR ID
 N79
 Cursor _____ (0.01°)
 Spiral _____
 PRO _____
 N79
 Cursor _____
 Spiral _____
 PRO _____
 N79
 Cursor _____
 Spiral _____
 PRO, PRO _____
 N05 _____ Star Angle Difference (0.01°)
 PRO _____
 N93 _____ X Torquing Angles (0.001°)
 _____ Y
 _____ Z
 PRO (Gyro Torquing), GET ____:__:____
 N25 00014, ENTR (TERM)
 OOE

3rd P57

P57E, R2 00004
 N34 Load TIG, PRO
 N06 00010
 00003
 00110
 PRO
 (No Att light - On/Off, Twice)
 N04 + _____ Gravity Error (0.01°)
 V32E
 N04 + _____ Gravity Error
 PRO
 N22 ICDU Angles
 PRO (No Att light - On/Off)
 N70/71 _____ STAR ID
 N79
 Cursor _____ (0.01°)
 Spiral _____
 PRO _____
 N79
 Cursor _____
 Spiral _____
 PRO _____
 N79
 Cursor _____
 Spiral _____
 PRO, PRO _____
 N05 _____ Star Angle Difference (0.01°)
 PRO _____
 N93 _____ X Torquing Angles (0.001°)
 _____ Y
 _____ Z
 PRO (Gyro Torquing), GET ____:__:____
 N25 00014, ENTR (TERM)
 OOE

APOLLO 16 P 57's

The first P-57 subsequent to touchdown is a realignment to the landing site REFSMMAT. This is accomplished via selection of Option 3. The second and third P-57's are performed in preparation for ascent after power up. These are both performed to Option 4, which specifies the IMU Orientation to the liftoff REFSMMAT at TIG.

All P-57's are performed via Technique 3 which specifies alignment using data from gravity and one star sighting.

$$\begin{bmatrix} X_{SM} \\ Y_{SM} \\ Z_{SM} \end{bmatrix} = \begin{bmatrix} \text{Landing Site} \\ \text{REFSMMAT} \end{bmatrix} \quad \bar{1}_{ECI} = \begin{bmatrix} \text{Unit}(\bar{r}_{LS-TIG}) \\ \text{Unit}(\bar{z}_{SM} \times \bar{x}_{SM}) \\ \text{Unit}[(\bar{r}_{CSM} \times \bar{v}_{CSM})_{TIG} \times \bar{x}_{SM}] \end{bmatrix} \begin{bmatrix} X_{ECI} \\ Y_{ECI} \\ Z_{ECI} \end{bmatrix}$$

$$\begin{bmatrix} \bar{s}_A \\ \text{(specified)} \end{bmatrix} = \begin{bmatrix} \text{Unit}(\bar{r}_{LS-TIG}) \\ \text{Unit}(\bar{r}_{LS-TIG} \times \bar{s}_2) \times \bar{1}_{LS-TIG} \\ \text{Unit}(\bar{r}_{LS-TIG} \times \bar{s}_2) \end{bmatrix} \begin{bmatrix} X_{SMD} \\ Y_{SMD} \\ Z_{SMD} \end{bmatrix} \quad \bar{s}_B = \begin{bmatrix} \text{Unit} \bar{g}_{LS} \\ \text{Unit}(\bar{g}_{LS} \times \bar{s}_2) \times \bar{g}_{LS} \\ \text{Unit}(\bar{g}_{LS} \times \bar{s}_2) \end{bmatrix} \begin{bmatrix} X_{SM} \\ Y_{SM} \\ Z_{SM} \end{bmatrix}$$

$$[\bar{s}_A] = [A][\bar{1}_{SMD}] \quad [\bar{s}_B] = [B][\bar{1}_{SM}]$$

$$[\bar{1}_{SMD}] = [B]^T [A][\bar{1}_{SM}]$$

$[\bar{1}_{SMD}]$ - CALGTA - GTA's

LUNAR SURFACE ALIGNMENT
AOT DETENT POSITIONS

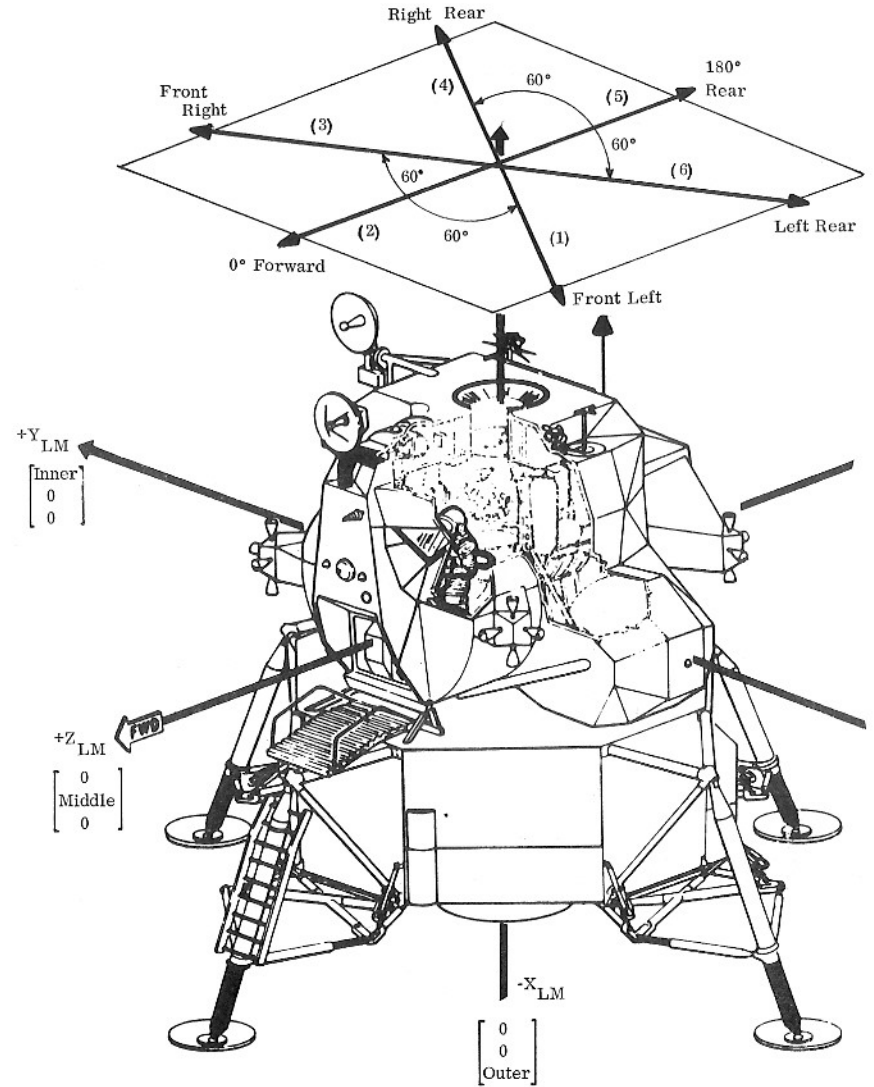

LUNAR SURFACE ALIGNMENT - P57

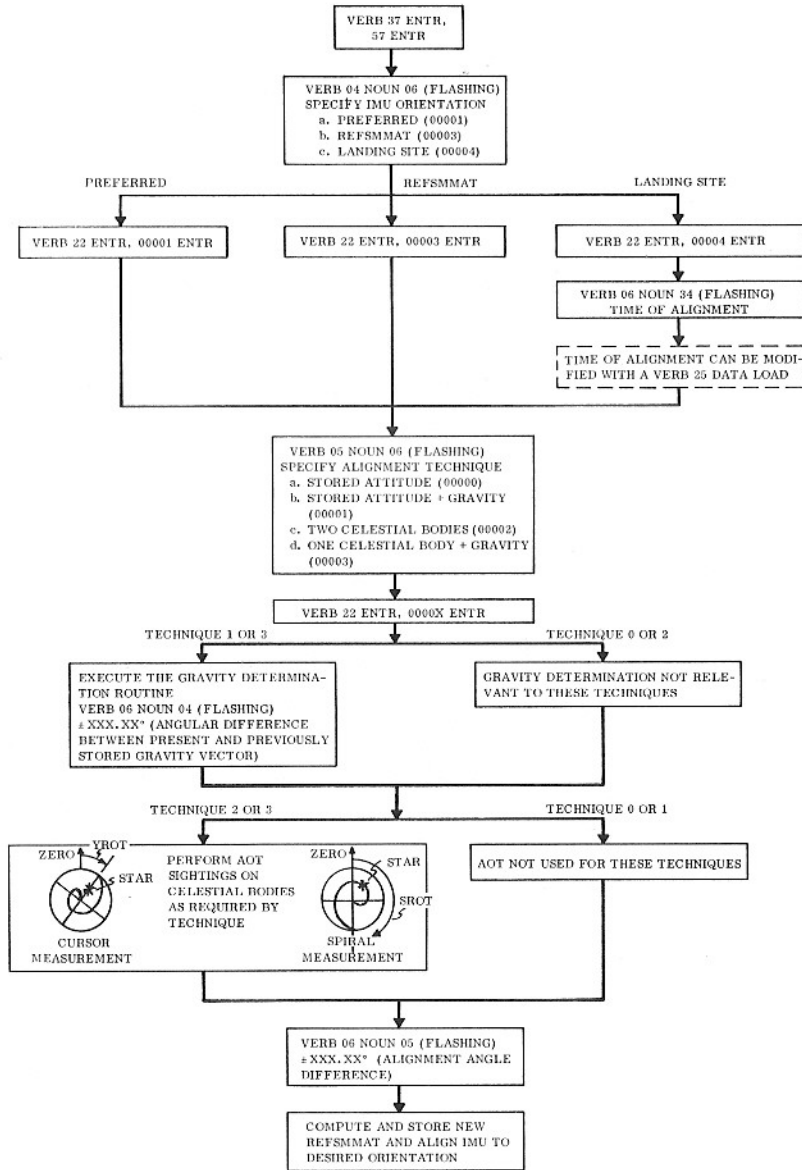
LUNAR SURFACE ALIGNMENT
GRAVITY DETERMINATION ROUTINE

1. COARSE ALIGN THE IMU TO THE FIRST ORIENTATION:

$$\begin{aligned} \text{OGA} &\approx +42^\circ \\ \text{MGA} &\approx +35.25^\circ \\ \text{IGA} &\approx -42^\circ \end{aligned}$$

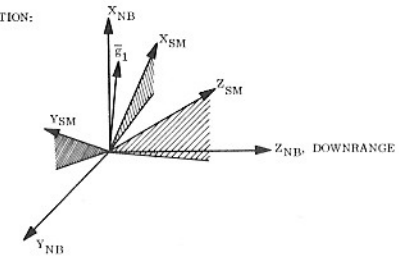

2. PLACE THE IMU IN AN INERTIAL MODE AND SAMPLE THE OUTPUT OF THE PIPA'S OVER A PERIOD OF 40 SECONDS. (PIPA
- _X
- , PIPA
- _Y
- , PIPA
- _Z
-). FORM A UNIT VECTOR
- \hat{e}_1

$$\hat{e}_1 = \frac{\text{PIPA}_X \hat{x}_{SM} + \text{PIPA}_Y \hat{y}_{SM} + \text{PIPA}_Z \hat{z}_{SM}}{\sqrt{\text{PIPA}_X^2 + \text{PIPA}_Y^2 + \text{PIPA}_Z^2}}$$

WHERE \hat{e}_1 INDICATES THE DIRECTION OF THE FIRST ESTIMATE OF THE LUNAR GRAVITY VECTOR IN SM COORDINATES.

3. COARSE ALIGN THE STABLE MEMBER 180° ABOUT THE MEASURED GRAVITY VECTOR.

$$\begin{aligned} \text{OGA} &\approx -138^\circ \\ \text{MGA} &\approx +35.25^\circ \\ \text{IGA} &\approx -42^\circ \end{aligned}$$

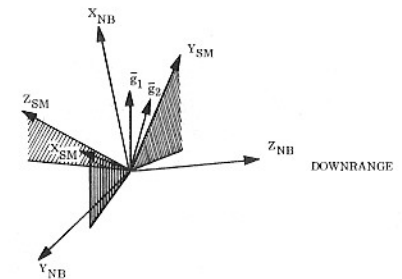

4. PLACE THE IMU IN AN INERTIAL MODE AND SAMPLE THE OUTPUT OF THE PIPA'S OVER A PERIOD OF 40 SECONDS (PIPA
- _X
- , PIPA
- _Y
- , PIPA
- _Z
-). FORM A UNIT VECTOR
- \hat{e}_2

$$\hat{e}_2 = \frac{\text{PIPA}_X \hat{x}_{SM} + \text{PIPA}_Y \hat{y}_{SM} + \text{PIPA}_Z \hat{z}_{SM}}{\sqrt{\text{PIPA}_X^2 + \text{PIPA}_Y^2 + \text{PIPA}_Z^2}}$$

WHERE \hat{e}_2 INDICATES THE DIRECTION OF THE SECOND ESTIMATE OF THE LUNAR GRAVITY VECTOR IN SM COORDINATES.

5. DEFINE A UNIT VECTOR
- \hat{U}_G
- OUT OF
- \hat{e}_1
- AND
- \hat{e}_2
- WHICH REPRESENTS THE DIRECTION OF THE LUNAR GRAVITY VECTOR.

$$\hat{U}_G = \text{UNIT}(\hat{e}_1 + \hat{e}_2)$$

NOTE: THE \hat{R}_{LS} VECTOR IS CONSIDERED TO BE COLINEAR WITH THE GRAVITY VECTOR.

LUNAR SURFACE ALIGNMENT - P57

TECHNIQUE	LOS DIRECTION IN BASIC REF. COORDINATES	ABSOLUTE INERTIAL REFERENCE
0	<p>LM + \vec{V} and \vec{Z} stored from previous alignment (P57, P68)</p>	$\vec{s}_A = \begin{bmatrix} \vec{V} \\ (\vec{Y} \times \vec{Z}) \times \vec{Y} \\ \vec{V} \times \vec{Z} \end{bmatrix} \vec{I}_{MCI} \hat{=} [A] \vec{I}_{MCI}$ $\vec{s}_B = \begin{bmatrix} \vec{V}_M \\ (\vec{V}_M \times \vec{Z}_M) \times \vec{V}_M \\ \vec{V}_M \times \vec{Z}_M \end{bmatrix} \vec{I}_{SMCS} \hat{=} [B] \vec{I}_{SMCS}$ $\vec{s}_A = [A] \vec{I}_{MCI} - \vec{s}_B = [B] \vec{I}_{SMCS}$ $\vec{I}_{SMCS} = [REFSMMAT] \vec{I}_{MCI} = [B]^{-1} [A] \vec{I}_{MCI}$
1	<p>\vec{Z}_L, \vec{r}_{LS} stored in MCI</p>	$\vec{s}_A = \begin{bmatrix} \vec{r}_{LS} \\ (\vec{r}_{LS} \times \vec{Z}) \times \vec{r}_{LS} \\ \vec{r}_{LS} \times \vec{Z} \end{bmatrix} \vec{I}_{MCI} \hat{=} [A] \vec{I}_{MCI}$ $\vec{s}_B = \begin{bmatrix} \vec{r}_{LS} \\ (\vec{r}_{LS} \times \vec{Z}_M) \times \vec{r}_{LS} \\ \vec{r}_{LS} \times \vec{Z}_M \end{bmatrix} \vec{I}_{SMCS} \hat{=} [B] \vec{I}_{SMCS}$ $\vec{I}_{SMCS} = [REFSMMAT] \vec{I}_{MCI} = [B]^{-1} [A] \vec{I}_{MCI}$
2	<p>\vec{s}_1, \vec{s}_2 Star Catalog</p>	$\vec{s}_A = \begin{bmatrix} \vec{s}_1 \\ (\vec{s}_1 \times \vec{s}_2) \times \vec{s}_1 \\ \vec{s}_1 \times \vec{s}_2 \end{bmatrix} \vec{I}_{MCI} \hat{=} [A] \vec{I}_{MCI}$ $\vec{s}_B = \begin{bmatrix} \vec{s}_{1M} \\ (\vec{s}_{1M} \times \vec{s}_{2M}) \times \vec{s}_{1M} \\ \vec{s}_{1M} \times \vec{s}_{2M} \end{bmatrix} \vec{I}_{SMCS} \hat{=} [B] \vec{I}_{SMCS}$ $\vec{I}_{SMCS} = [REFSMMAT] \vec{I}_{MCI} = [B]^{-1} [A] \vec{I}_{MCI}$
3		$\vec{s}_A = \begin{bmatrix} \vec{r}_{LS} \\ (\vec{r}_{LS} \times \vec{s}_2) \times \vec{r}_{LS} \\ \vec{r}_{LS} \times \vec{s}_2 \end{bmatrix} \vec{I}_{MCI} \hat{=} [A] \vec{I}_{MCI}$ $\vec{s}_B = \begin{bmatrix} \vec{r}_{LS} \\ (\vec{r}_{LS} \times \vec{s}_{2M}) \times \vec{r}_{LS} \\ \vec{r}_{LS} \times \vec{s}_{2M} \end{bmatrix} \vec{I}_{SMCS} \hat{=} [B] \vec{I}_{SMCS}$ $\vec{I}_{SMCS} = [REFSMMAT] \vec{I}_{MCI} = [B]^{-1} [A] \vec{I}_{MCI}$

MCI = Moon Centered Inertial; SMCS = Stable Member Coordinate System

P24 - LANDMARK TRACKING

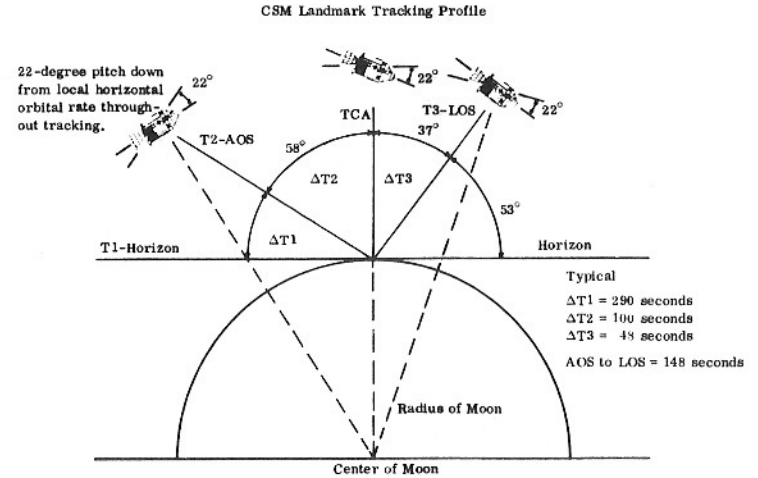

TGT:	()
T ₁	---:---:---
T ₂	---:---:---
TCA	---:---:---
T ₃	---:---:---
R	*P---*Y---* (T2 ACQ)
N or S nmi	/ SA--- TA--- (T2 ACQ)
N89 LAT	---.---
LONG/2	---.---
ALT	---.---
TGT:	()
T ₁	---:---:---
T ₂	---:---:---
TCA	---:---:---
T ₃	---:---:---
R	*P---*Y---* (T2 ACQ)
N or S nmi	/ SA--- TA--- (T2 ACQ)
N89 LAT	---.---
LONG/2	---.---
ALT	---.---

P24 RATE-AIDED OPTICS TRACKING	
	CMC - on (req)
	ISS - on and aligned
	SCS - on
	BMAG MODE (3) - RATE 2
	G&N PWR OPTICS - on
	OPT ZERO - ZERO (verify)
	OPT MODE - CMC
	V37E 24E
F 06 89	LAT, LONG/2, ALT (0.001°, 0.001°, 0.01 nmi)
	LOAD LMK COORDS
	OPT ZERO - OFF
	PRO
06 92	AUTO OPT SHF/TRUN (0.01°, 0.001°)
	• F 05 09 00404 (TRUN > 90°)
	• MNVR to acquire
	• PRO
	• or V34E, F 37
	OPTICS MODE - MAN
F 51	MARK REQUEST
	MARK (as often as desired)
	To terminate:
	PRO
F 37	XXE
	OPT ZERO - ZERO

P24 - LANDMARK TRACKING
MARK DATA

+	0	0			Hours	+	0	0		
+	0	0	0		Minutes GET	+	0	0	0	
+	0				Seconds	+	0			
+					P IMU Gimbal Angles (degree)	+				
+					Y	+				
+					R	+				
+					Shaft SXT Angles (degree)	+				
+					Trunnion	+				

+	0	0			Hours	+	0	0		
+	0	0	0		Minutes GET	+	0	0	0	
+	0				Seconds	+	0			
+					P IMU Gimbal Angles (degree)	+				
+					Y	+				
+					R	+				
+					Shaft SXT Angles (degree)	+				
+					Trunnion	+				

+	0	0			Hours	+	0	0		
+	0	0	0		Minutes GET	+	0	0	0	
+	0				Seconds	+	0			
+					P IMU Gimbal Angles (degree)	+				
+					Y	+				
+					R	+				
+					Shaft SXT Angles (degree)	+				
+					Trunnion	+				

NOTES:

P30-EXTERNAL ΔV
TEI 26 & TEI 32

V37 Enter, 30 Enter

V06 N33 Flashing, Load Desired GETI

V06 N81 Flashing, Load Desired ΔV

					Purpose Prop/Guidance					
+					Weight (lb) N47	+				
	0	0			PTrim (degrees) N48		0	0		
	0	0			YTrim		0	0		
+	0	0			Hours N33	+	0	0		
+	0	0	0		Minutes GETI	+	0	0	0	
+	0				Seconds	+	0			
					ΔV _X N81					
					ΔV _Y LV					
					ΔV _Z (ft/s)					
X	X	X			R IMU Gimbal Angles (deg)	X	X	X		
X	X	X			P	X	X	X		
X	X	X			Y	X	X	X		
+					H _A Apogee nmi N44	+				
					H _P Perigee					
+					ΔVT (ft/s)	+				
X	X	X			BT (min.s)	X	X	X		
X					ΔVC (ft/s)	X				
X	X	X	X		SXT Star	X	X	X	X	
+				0	SFT (degrees)	+				0
+				0	TRN (degrees)	+			0	0
X	X	X			BSS (Coas Star)	X	X	X		
X	X				SPA (Coas Pitch, deg)	X	X			
X	X	X			SXP (Coas X Pos, deg)	X	X	X		
	0				LAT (degrees) N61		0			
					LONG					
+					RTGO (nmi) EMS	+				
+					VIO (ft/s)	+				
					GET 0.05 g Hr:min:s					
					SET STARS					
X	X	X			RAlign	X	X	X		
X	X	X			PAlign	X	X	X		
X	X	X			YAlign	X	X	X		
					ULLAGE					

NOTES:

P30-EXTERNAL ΔV

TEI 42

V37 Enter, 30 Enter

V06 N33 Flashing, Load Desired GETI

V06 N81 Flashing, Load Desired ΔV

				Purpose					
				Prop/Guidance					
+				Weight (lb)	N47	+			
0	0			PTrim	N48	0	0		
0	0			YTrim (degrees)		0	0		
+	0	0		Hours	N33	+	0	0	
+	0	0	0	Minutes GETI		+	0	0	0
+	0			Seconds		+	0		
				ΔV _X	N81				
				ΔV _Y LV					
				ΔV _Z (ft/s)					
X	X	X		R		X	X	X	
X	X	X		P IMU Gimbal Angles (deg)		X	X	X	
X	X	X		Y		X	X	X	
+				HApogee nmi	N44	+			
				HPerigee					
+				ΔVT (ft/s)		+			
X	X	X		BT (min:s)		X	X	X	
X				ΔVC (ft/s)		X			
X	X	X	X	SXT Star		X	X	X	X
+			0	SFT (degrees)		+			0
+			0 0	TRN (degrees)		+			0 0
X	X	X		BSS (Coas Star)		X	X	X	
X	X			SPA (Coas Pitch, deg)		X	X		
X	X	X		SXP (Coas X Pos, deg)		X	X	X	
0				LAT (degrees)	N61	0			
				LONG					
+				RTGO (nmi) EMS		+			
+				VIO (ft/s)		+			
				GET 0.05 g Hr:min:s					
				SET STARS					
X	X	X		RAlign		X	X	X	
X	X	X		PAlign		X	X	X	
X	X	X		YAlign		X	X	X	
				ULLAGE					

NOTES:

P30-EXTERNAL ΔV

Plane Change 1 & TEI 53

V37 Enter, 30 Enter

V06 N33 Flashing, Load Desired GETI

V06 N81 Flashing, Load Desired ΔV

				Purpose					
				Prop/Guidance					
+				Weight (lb)	N47	+			
0	0			PTrim	N48	0	0		
0	0			YTrim (degrees)		0	0		
+	0	0		Hours	N33	+	0	0	
+	0	0	0	Minutes GETI		+	0	0	0
+	0			Seconds		+	0		
				ΔV _X	N81				
				ΔV _Y LV					
				ΔV _Z (ft/s)					
X	X	X		R		X	X	X	
X	X	X		P IMU Gimbal Angles (deg)		X	X	X	
X	X	X		Y		X	X	X	
+				HApogee nmi	N44	+			
				HPerigee					
+				ΔVT (ft/s)		+			
X	X	X		BT (min:s)		X	X	X	
X				ΔVC (ft/s)		X			
X	X	X	X	SXT Star		X	X	X	X
+			0	SFT (degrees)		+			0
+			0 0	TRN (degrees)		+			0 0
X	X	X		BSS (Coas Star)		X	X	X	
X	X			SPA (Coas Pitch, deg)		X	X		
X	X	X		SXP (Coas X Pos, deg)		X	X	X	
0				LAT (degrees)	N61	0			
				LONG					
+				RTGO (nmi) EMS		+			
+				VIO (ft/s)		+			
				GET 0.05 g Hr:min:s					
				SET STARS					
X	X	X		RAlign		X	X	X	
X	X	X		PAlign		X	X	X	
X	X	X		YAlign		X	X	X	
				ULLAGE					

NOTES:

P24 - LANDMARK TRACKING

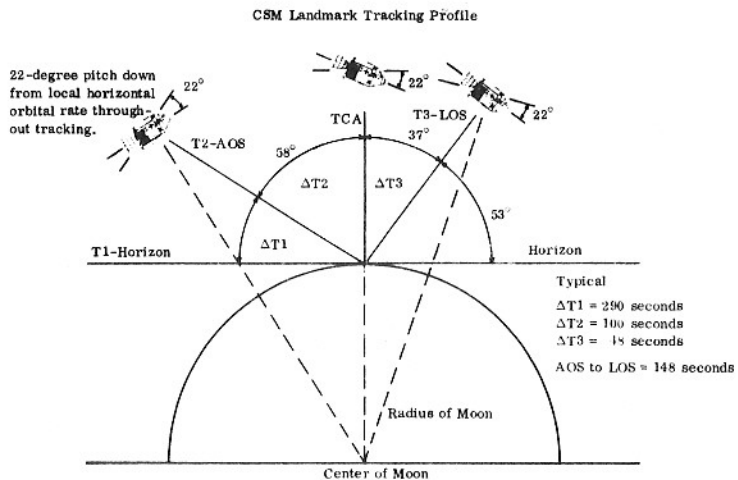

TGT: ()

T₁ _ _ _ : _ _ : _ _ _

T₂ _ _ _ : _ _ : _ _ _

TCA _ _ _ : _ _ : _ _ _

T₃ _ _ _ : _ _ : _ _ _

R _ _ _ * P _ _ _ * Y _ _ _ * (T2 ACQ)

N or S nmi _ _ / SA _ _ TA _ _ (T2 ACQ)

N89 LAT _ _ . _ _ _ _ _

LONG/2 _ _ . _ _ _ _ _

ALT _ _ . _ _ _ _ _

TGT: ()

T₁ _ _ _ : _ _ : _ _ _

T₂ _ _ _ : _ _ : _ _ _

TCA _ _ _ : _ _ : _ _ _

T₃ _ _ _ : _ _ : _ _ _

R _ _ _ * P _ _ _ * Y _ _ _ * (T2 ACQ)

N or S nmi _ _ / SA _ _ TA _ _ (T2 ACQ)

N89 LAT _ _ . _ _ _ _ _

LONG/2 _ _ . _ _ _ _ _

ALT _ _ . _ _ _ _ _

P24 RATE-AIDED OPTICS TRACKING

CMC - on (req)
 ISS - on and aligned
 SCS - on
 BMAG MODE (3) - RATE 2
 G&N PWR OPTICS - on
 OPT ZERO - ZERO (verify)
 OPT MODE - CMC

V37E 24E

F 06 89 LAT, LONG/2, ALT (0.001°, 0.001°, 0.01 nmi)
 LOAD LMK COORDS
 OPT ZERO - OFF
 PRO

06 92 AUTO OPT SHF/TRUN (0.01°, 0.001°)
 • F 05 09 00404 (TRUN > 90°)
 • MNVR to acquire
 • PRO
 • or V34E, F 37
 OPTICS MODE - MAN

F 51 MARK REQUEST
 MARK (as often as desired)
 To terminate:
 PRO

F 37 XXE
 OPT ZERO - ZERO

P24 - LANDMARK TRACKING
 MARK DATA

+	0	0			Hours		+	0	0			
+	0	0	0		Minutes	GET	+	0	0	0		
+	0				Seconds		+	0				
+					P		+					
+					Y	IMU Gimbal Angles (degree)	+					
+					R		+					
+					Shaft	SXT Angles (degree)	+					
+					Trunnion		+					

+	0	0			Hours		+	0	0			
+	0	0	0		Minutes	GET	+	0	0	0		
+	0				Seconds		+	0				
+					P		+					
+					Y	IMU Gimbal Angles (degree)	+					
+					R		+					
+					Shaft	SXT Angles (degree)	+					
+					Trunnion		+					

+	0	0			Hours		+	0	0			
+	0	0	0		Minutes	GET	+	0	0	0		
+	0				Seconds		+	0				
+					P		+					
+					Y	IMU Gimbal Angles (degree)	+					
+					R		+					
+					Shaft	SXT Angles (degree)	+					
+					Trunnion		+					

NOTES:

P22-LUNAR SURFACE NAVIGATION

V37 Enter, 22 Enter

V04 N06 Flashing

R1: 0 0 0 1 2

R2: 0 0 0 0 X (1-CSM will not change orbit,
2-CSM will change orbit)

V06 N33 Flashing

Time of ascent (h, min, 0.01 s)

V50 N25 Flashing (if RR Auto mode not selected)

R1: 0 0 2 0 1 - switch RR mode to Auto

X	0	0	0	0	0	Option Code	N06	X	0	0	0	0	0		
+	0	0				Hours	N33	+	0	0					
+	0	0	0			Minutes		+	0	0	0				
+	0					Seconds		+	0						
X	0	0	0	0	0	Option Code	N06	X	0	0	0	0	0		
+	0	0				Hours	N33	+	0	0					
+	0	0	0			Minutes		+	0	0	0				
+	0					Seconds		+	0						
X	0	0	0	0	0	Option Code	N06	X	0	0	0	0	0		
+	0	0				Hours	N33	+	0	0					
+	0	0	0			Minutes		+	0	0	0				
+	0					Seconds		+	0						

NOTES:

P12-POWERED ASCENT

V37 Enter, 12 Enter

V06 N33 Flashing

Time of ascent (h, min, 0.01 s)

V06 N76 Flashing

Downrange velocity, radial velocity, crossrange (0.1 ft/s, 0.1 ft/s, 0.1 nmi)

V50 N25 Flashing

R1: 0 0 2 0 3 (switch Guidance Control to PGNS, Mode to Auto)

V06 N74 Flashing

TFI, yaw after rise, pitch after rise (min/s, 0.01 deg, 0.01 deg)

V99 N74 Flashing

Engine on enable

V06 N94 Flashing

VGX, HDOT, H (0.1 ft/s, 0.1 ft/s, ft)

V16 N85 Flashing

VGX (LM), VGY (LM), VGZ (LM) (0.1 ft/s)

V82 Enter

V16 N44 Flashing

Apocenter altitude, pericenter altitude, TFF (0.1 nmi, 0.1 nmi, min/s)

+	0	0				Hours	N33	+	0	0					
+	0	0	0			Minutes		+	0	0	0				
+	0					Seconds		+	0						
+						Desired Downrange Velocity (ft/s)	N76	+							
+						Desired Radial Velocity (ft/s)		+							
0						*Crossrange Distance (nmi)		0							
						047 Sine of Azimuth Angle (Octal) (AGS)									
						053 Cosine of Azimuth Angle (Octal) (AGS)									
						224/226 Semimajor Axis at Insertion (k ft) (AGS)									
						231 Landing Site Radius (k ft) (AGS)									
						465 Target Radial Rate at Insertion (ft/s) (AGS)									
						373 TIG of TPI (min) (AGS)									
+	0	0				Hours	N37	+	0	0					
+	0	0	0			Minutes		+	0	0	0				
+	0					Seconds		+	0						
+						LM Weight (lb)		+							
+						H _{Apogee}		+							
+						H _{Perigee}		+							

*Load 8 nmi if crossrange is greater than 8 nmi.

NOTES:

TIME	RANGE	RDOT
L0+5	140	1660
L0+6	152	813
L0+7	155	-175
INS	155	-449
1+00	151	-446
2+00	146	-442
3+00	142	-438
4+00	138	-433
5+00	133	-428
6+00	129	-422
7+00	125	-416
8+00	121	-409
9+00	117	-402
10+00	113	-395

INSERTION 171:52:23		
V82		ATT CONT-PULSE
V76		MODE CONT-AUTO
AGS MODE CONT-ATT HOLD		
RR MODE-LGC		
RATE/ERR MON(2)-RNDZ RDR		*
SHFT/TRUN ±5		
RATE SCALE 5°/SEC		
RNG/ALT MON-RNG/RNG RT		
*VHF ANT-FWD		*
*400+2 Z-AXIS STEER		*
*410+4 TPI EXEC		*
*616+00005 ULLAGE		*
*623+0		*
*COPY AGS DATA		*
AUDIO MODE(2)-ICS/PTT		*
√INV 2, CB INV 1-OPEN		*
CB(11) & (16) ED: LOGIC PWR-OPEN		*
CB(11) ECS CABIN FAN1-CLOSE		*
+1 GO/NO-GO FOR TWEAK		
P47 FDAI (0,257,0)		
*404+0, 405+0, 406+0		*
*MONITOR 470, 471, 472		*
+3 TWEAK 171:55:23		
ΔV'S		

INSERTION THRU TPI

P47 FDAI (0,242,0) OR 10° OHW
*404+0, 405+0, 406+0 *
*MONITOR 470, 471, 472 *
40 LM BAILOUT @ L.O.+12:10
TIG 171:57:19
ΔVX 41.6

P20, AUTO MNVR
V80, MAX N49(2.00,12.0)
RR-AUTO TRACK
P34 TGT TPI
*VERIFY PGNS WITH MSFN *
*V47, 414+1, 400+3 *
*400+2 Z-AXIS STEER *
*417+1 (/417+0) *
*411+1 START AUTO(19,18) *
*310R SET DET *
*303R @ TPI *
V82
V83 SET ORDEAL (35NM)
*317R, 440R, 277R *
V48, 12012
LM WT
33 CSM BAILOUT GET P76 PAD
*EXT LTG-TRACK *
30 CHART R/ROOT
RDOT
27
M=15, V32
24
*COMPARE CMC, AGS, VHF/RR *
*POLAR PLOT @ 90 NM *
21
18
*CHECK RCS, EPS, ECS *

15	*514+0	RDOT
	*515+4 YAW STEER VEC	*
	*516+0	*
	*MATCH INDICATED ANGLES *	
	*TRACK MODE-SLEW *	
	*S-BD ANT-AFT *	
	SET P (+127) *	
	Y (-50) *	
	*BIOMED-OFF, PCM-HI *	
	*UPLINK SQUELCH-ENABLE *	
12		RDOT
10	CHART R/RDOT	
9		RDOT
8	PRO-FINAL COMP	
	*411+0 STOP AUTO	*
6	*COMPARE CMC, AGS	*
	CHECK TIG OF CSM	
	*DET & APS BURN CARD *	
	P42 N86	
	PERFORM YAW/ROLL MANEUVER	
	*404+0, 405+0, 406+0 *	
	*623+1	*
	*400+1 GUID STEER	ATT CONT-MODE CONT
5	*410+5	*
	*500R	*
1:00	AGS MODE CONT-AUTO	
:30	ABORT STAGE PB-PUSH	
:10	MANUAL ULLAGE	
:05	PRO	
:00	TPI 174:12:41 172:39:13	
	ABORT STAGE PB-RESET	
	NO IGNITION	
	ENG ARM-ASC	
	MANUAL START	
	MANUAL STOP 3 SEC	
	ENG ARM-OFF	
	NULL RESIDUALS	

0	TPI 172:39:13	
	V76, AGS MODE CONT-ATT HOLD	
	P35 TGT MCC 1	ATT CONT-PULSE
	MAX N49(0.80,5.0)	MODE CONT-AUTO
	V67 (+02000,+00020,+00005)	
	*400+0	*
	*623+0	*
	*417+1 (/621+0)	*
	*411+1 START AUTO(13,12)	*
2		RDOT
	*410+4 TPI EXEC	*
	*373+TPI TIME +15 MIN	*
	*307+028.00	*
4		RDOT
6		RDOT
8		RDOT
9	CHART	*
10		RDOT
12	PRO FINAL COMP	RDOT
13	CHART R/RDOT	
	*411+0 STOP AUTO	*
	370R TOTAL VEL MCC1	
	371R ΔV TPF	
	*404+0, 405+0, 406+0 *	
	P41, V77	
14	*410+5	ATT CONT-MODE CONT
	*502R	
:05	*472R/502R	A/H
15	MCC1	
	NULL RESIDUALS	

TPI THRU DOCKING

V76
P35 TGT MCC 2
V93
*VERIFY PGNS (PCM-HI) *
*V47, 414+1, 400+3 *
*411+1 START AUTO *
*EXT LTG-OFF *
17
*410+4 TPI EXEC
*373+TPI TIME +30 MIN
*307+013.00
19
21
23
24
25
27
28
*411+0 STOP AUTO
370R TOTAL VEL MCC2
371R ΔV TPF
*404+0, 405+0, 406+0 *
P41, V77
29
*410+5
*502R
:05
*472R/502R
30
MCC2
NULL RESIDUALS

P00
V48, 11002
P47, V63
*404+0, 405+0, 406+0 *
*S-BD ANT-AFT, VERIFY COMM *
*S-BD P (+127) *
Y (-50) *
*S-BD ANT-SLEW (>3.0) *
*TRACK MODE-AUTO *
*BIOMED-LEFT, PCM-HI *
*UPLINK SQUELCH-OFF *
TPI BURN REPORT
40
INITIATE BRAKING
30 FPS - 6000 FT
20 FPS - 3000 FT
10 FPS - 1500 FT
5 FPS - 600 FT
*SETUP CAMERA FOR
* DOCKING:
*LM3/DAC/10/CEX-ULC *
* (TB,1/250,6) 1FPS *
* .25 MAG(0), (4 MIN) *
V34, P00
V76
MANEUVER/PICTURES OF SIMBAY
55
INITIATE DOCKING
COAS TO OVHD WINDOW
*EXT LTG-DOCK *
SHFT/TRUN ±50
V41N72 (+000,+320)
CB RR(2)-OPEN, V44
FDAI LV(180,285,300)
V77
65
CONTACT
ATT CONT-MODE CONT
CONFIRM CAPTURE FROM CSM
MODE CONT (BOTH) - OFF

181-91

181-20

ASCENT DISPLAYS
(P12)

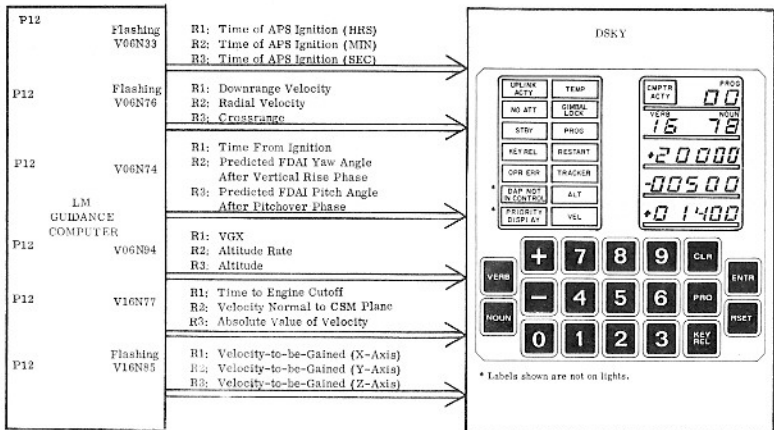
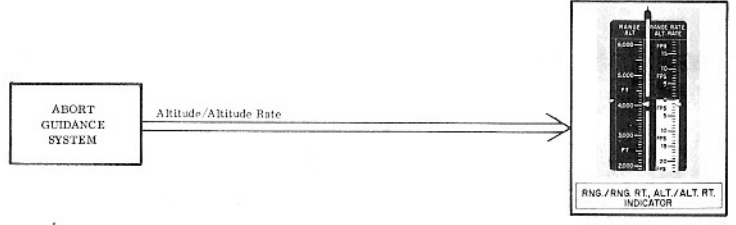
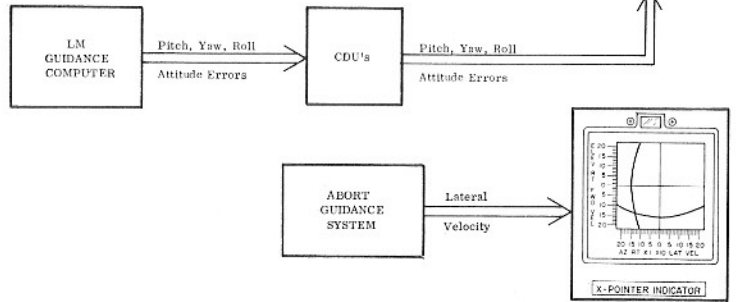
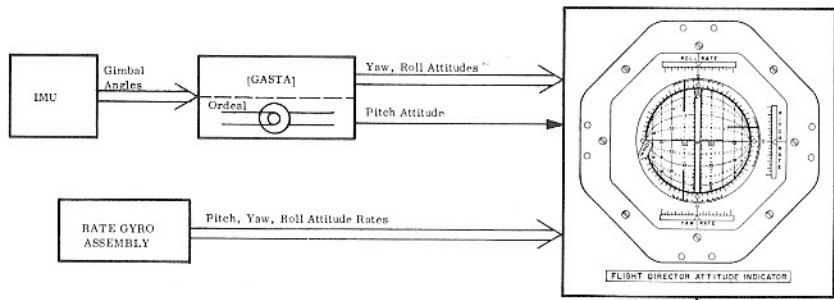

* Labels shown are not on lights.

ASCENT DISPLAYS

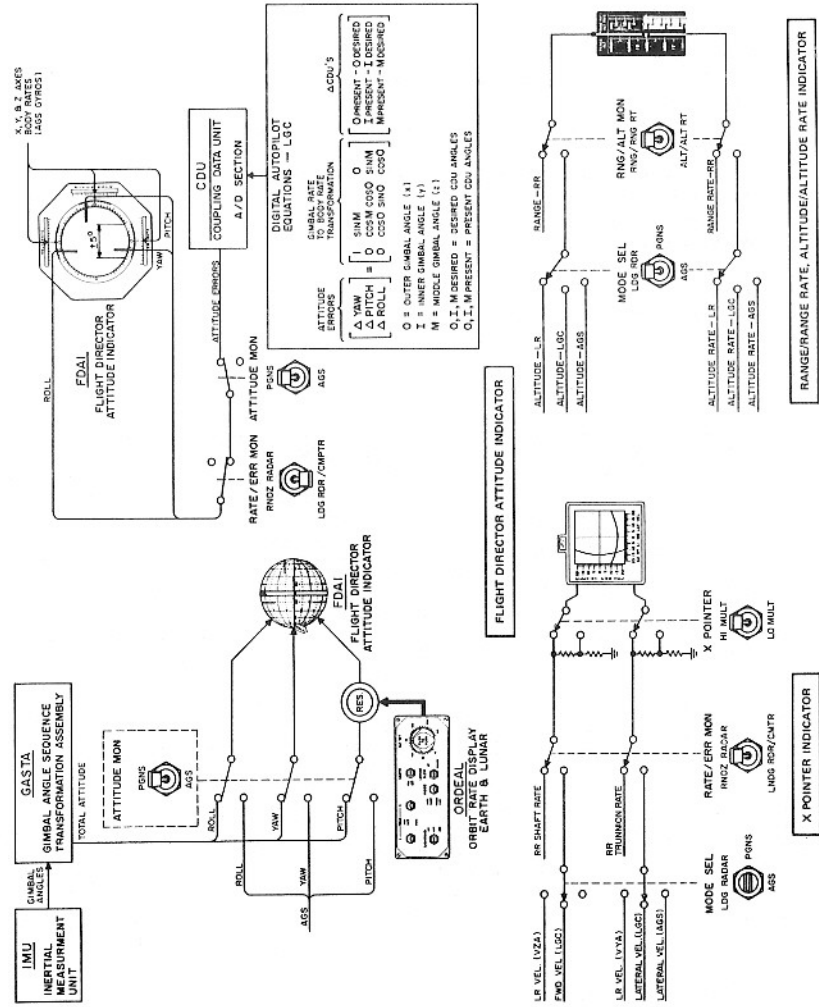

RANGE/RANGE RATE, ALTITUDE/ALTITUDE RATE INDICATOR

X POINTER INDICATOR

P12-POWERED ASCENT

- V37 Enter, 12 Enter
- V06 N33 Flashing
Time of ascent (h, min, 0.01 s)
- V06 N76 Flashing
Downrange velocity, radial velocity, crossrange (0.1 ft/s, 0.1 ft/s, 0.1 nmi)
- V50 N25 Flashing
R1: 0 0 2 0 3 (switch Guidance Control to PGNS, Mode to Auto)
- V06 N74 Flashing
TFI, yaw after rise, pitch after rise (min/s, 0.01 deg, 0.01 deg)
- V99 N74 Flashing
Engine on enable
- V06 N94 Flashing
VGX, HDOT, H (0.1 ft/s, 0.1 ft/s, ft)
- V16 N85 Flashing
VGX (LM), VGY (LM), VGZ (LM) (0.1 ft/s)
- V82 Enter
V16 N44 Flashing
Apocenter altitude, pericenter altitude, TFF (0.1 nmi, 0.1 nmi, min/s)

+	0	0			Hours	N33	+	0	0					
+	0	0	0		Minutes	TIG of Ascent	+	0	0	0				
+	0				Seconds		+	0						
+					Desired Downrange Velocity (ft/s)	N76	+							
+					Desired Radial Velocity (ft/s)		+							
	0				*Crossrange Distance (nmi)			0						
					047 Sine of Azimuth Angle (Octal) (AGS)									
					053 Cosine of Azimuth Angle (Octal) (AGS)									
					224/226 Semimajor Axis at Insertion (k ft) (AGS)									
					231 Landing Site Radius (k ft) (AGS)									
					485 Target Radial Rate at Insertion (ft/s) (AGS)									
					373 TIG of TPI (min) (AGS)									
+	0	0			Hours	N37	+	0	0					
+	0	0	0		Minutes	TIG of TPI	+	0	0	0				
+	0				Seconds		+	0						
+					LM Weight (lb)		+							
+					H _{Apogee}	CSM (nmi)	+							
+					H _{Perigee}		+							

*Load 8 nmi if crossrange is greater than 8 nmi.

NOTES:

LM INSERTION

EVENT		BT/ ΔV	G. E. T.	PROPULSION/ GUIDANCE	PRETHRUST TARGETING
INSERTION		434.3/ 6047.9	171:45:08.6	LM-APS/PGNS	P-12
RESIDUALS (ft/s)					h
ΔV_x	N85		500	+ x x	min GET
ΔV_y	PGNS		AGS 501	+ x x x	
ΔV_z			502	+ x	s
----- V_{xTRIM}		----- V_{yTRIM}		----- V_{zTRIM} (ft/s)	

REV 50

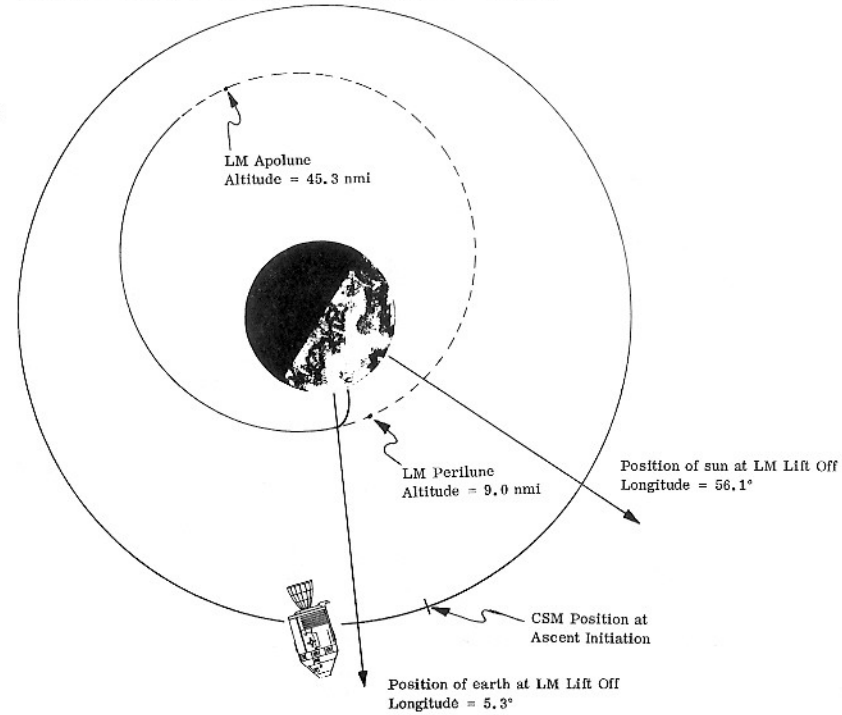

RENDEZVOUS

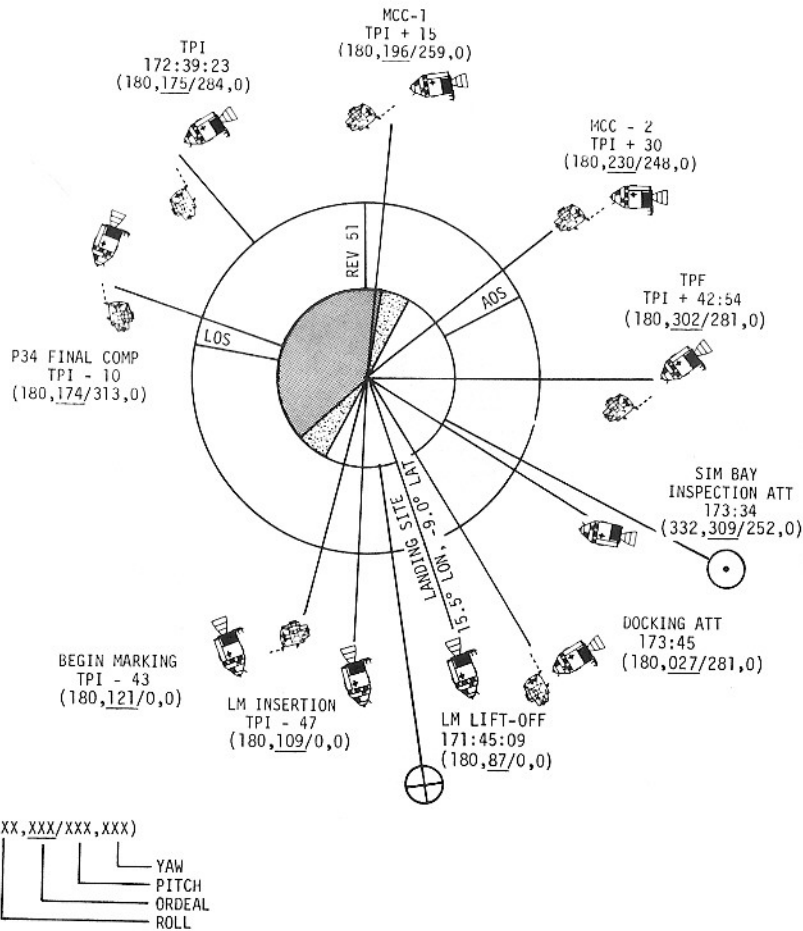

RENDEZVOUS DISPLAYS

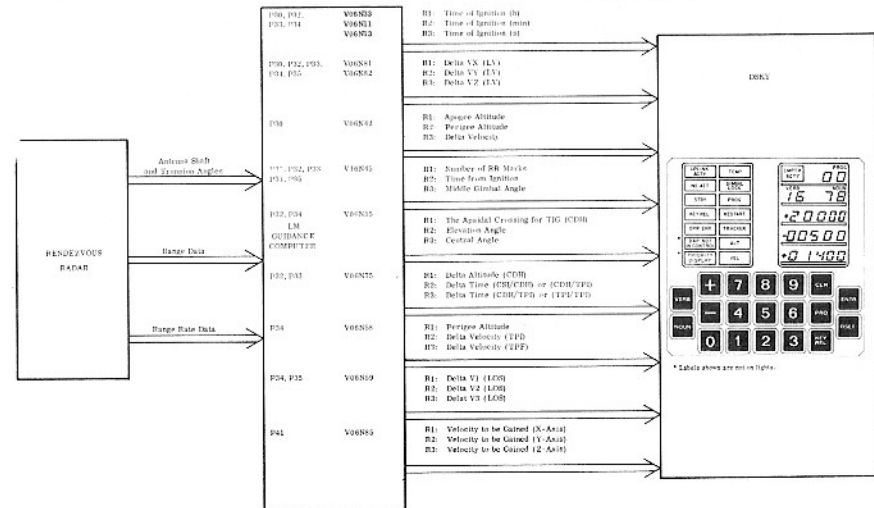
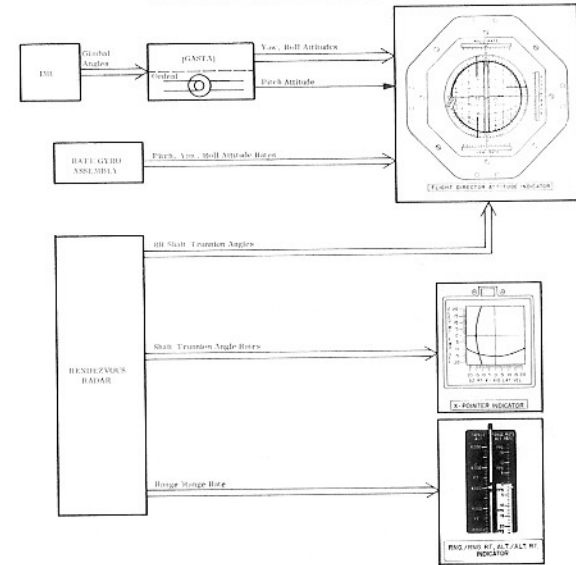

P34—TRANSFER PHASE INITIATION (TPI)

V37 Enter, 34 Enter

V06 N37 Flashing

TIG of TPI (h, min, 0.01 s)

V06 N55 Flashing

R2: Elevation angle, R3: Central angle (0.01 deg, 0.01 deg)

V16 N45 Flashing

Marks, time from ignition, middle gimbal angle (marks, min/s, 0.01 deg)

V06 N58 Flashing

Pericenter altitude, ΔV (TPI), ΔV (TPF) (0.1 nmi, 0.1 ft/s, 0.1 ft/s)

V06 N81 Flashing

ΔV_X (LV), ΔV_Y (LV), ΔV_Z (LV) for TPI (0.1 ft/s)

+	0	0			Hours		N37	+	0	0					
+	0	0	0		Minutes	TIG of TPI		+	0	0	0				
+	0				Seconds			+	0						
N55 (+00000) Conic Integration, (+00000)* Elevation Angle (+130.00) Central Angle															
	0				ΔV_X (LV)		N81		0						
	0				ΔV_Y (LV)	Components of ΔV in local vertical coordinates (ft/s)			0						
	0				ΔV_Z (LV)				0						
+	0				Range at TIG-5 min (nmi)		N54	+	0						
	0				Range rate at TIG-5 min (ft/s)				0						
X	X				Burn time (min/s)			X	X						

*P34 calculates Elevation Angle for given TIG of TPI

NOTES:

DIRECT TPI

PGNS												TIG TPI	N37
+	0					+	0					HP (nmi)	N58
+	0					+	0					ΔV TPI (ft/s)	
+	0					+	0					ΔV TPF (ft/s)	
												ΔV_X	N81
												ΔV_Y	LV (ft/s)
												ΔV_Z	
AGS												θ LOS (degl)	303
0						0						ΔV TPI (ft/s)	370
0						0						ΔV TPF (ft/s)	371
0						0						ΔV_X	450
												ΔV_Y	LV (ft/s) 451
												ΔV_Z	452
CSM												TIG TPI	N37
												ΔV_X	
												ΔV_Y	LV (ft/s)
												ΔV_Z	
CHANGE SIGN: BIAS, $\Delta V_X - 1.0$, $\Delta V_Z - 1.0$												ELEV	N55

BURN RULES

If two of three solutions agree, burn priority solution.

Priority of Solutions: PGNS, AGS, CMC, Charts

Guide Values: $\dot{X} = 3$ ft/s, $\dot{Y} = 7$ ft/s, $\dot{Z} = 9$ ft/s

RR agrees with VHF where $\Delta R = 0.01R + 0.5$ nmi, ΔR is always ≥ 1 nmi.

If RR does not agree with VHF, MSFN isolates failed system.

TRANSFER PHASE INITIATION

EVENT		BT/ ΔV	G. E. T.	PROPULSION/ GUIDANCE	PRETHRUST TARGETING
TPI		12, 5/72, 1	172:39:22, 9	LM-APS/PGNS LAMBERT (P-42)	P-34
RESIDUALS (ft/s)					
ΔV_x	N85		500	+ x x	h
ΔV_y	PGNS		AGS 501	+ x x x	min
ΔV_z			502	+ x	s
----- V_{xTRIM}		----- V_{yTRIM}		----- V_{zTRIM} (ft/s)	

REVS 50/51

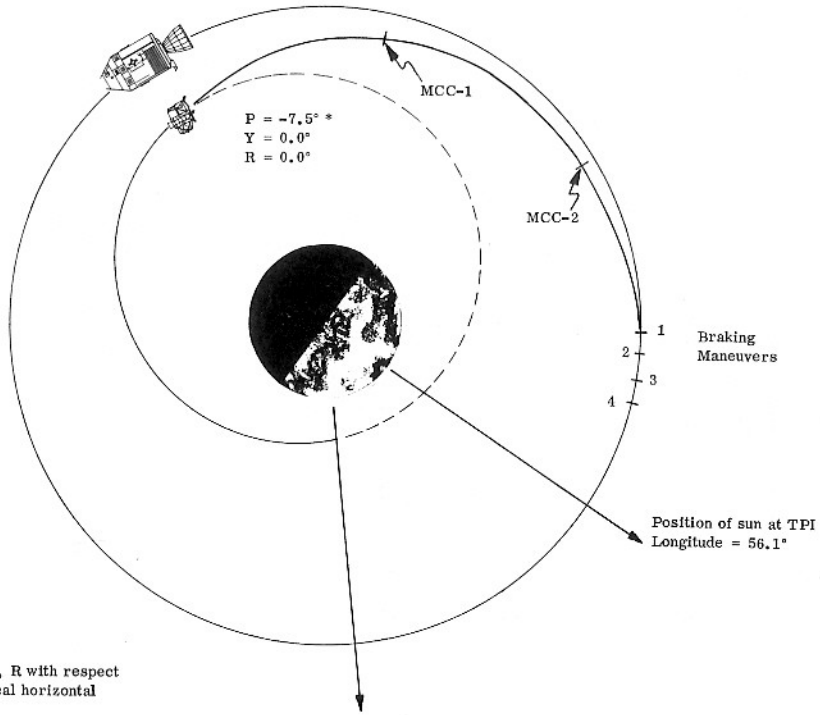

*P, Y, R with respect to local horizontal

Position of earth at TPI
Longitude = 5.3°

LM RENDEZVOUS FINAL PHASE

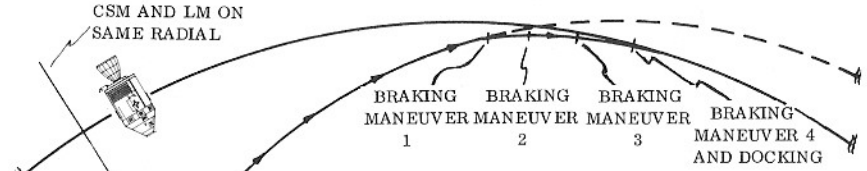

BRAKING MANEUVER DESCRIPTIONS

1. AT R = 3,000 FEET. MANEUVER REDUCES RANGE RATE FROM 32 TO 20 FT/S.
2. AT R = 1,500 FEET. MANEUVER REDUCES RANGE RATE FROM 20 TO 10 FT/S.
3. AT R = 500 FEET. MANEUVER REDUCES RANGE RATE FROM 10 TO 5 FT/S.
4. AT R = 100 FEET. MANEUVER REDUCES RANGE RATE FROM 5 TO 0 FT/S.

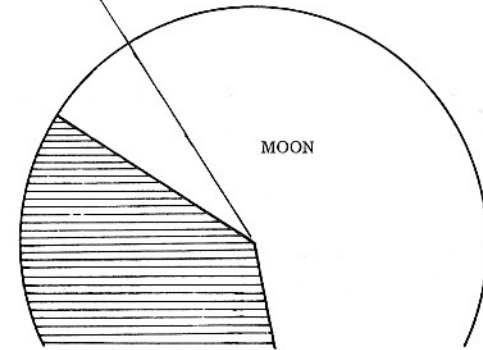

P30 - EXTERNAL ΔV (LM)

V37 Enter, 30 Enter
 V06 N33 Flashing, Load Desired GETI
 V06 N81 Flashing, Load Desired ΔV

						Purpose														
+	0	0				Hours	N33	+	0	0										
+	0	0	0			Minutes	GETI	+	0	0	0									
+	0					Seconds		+	0											
						ΔV _X	N81													
						ΔV _Y	LV													
						ΔV _Z	(ft/s)													
+						ΔVR (ft/s)		+												
X	X	X				BT (min:s)		X	X	X										
X	X	X				R	FDAI Inertial Angles (degrees)	X	X	X										
X	X	X				P		X	X	X										
						ΔV _X	N86													
						ΔV _Y	AGS Targeting (ft/s)													
						ΔV _Z														
+						H _A pogee	N42	+												
						H _P erigee (nmi)														
						ΔVT (ft/s)		+												

LM JETTISON PAD

+	0	0				Hours	GETI	+	0	0										
+	0	0	0			Minutes	JETT	+	0	0	0									
+	0					Seconds		+	0											
X	X	X				R	N22	X	X	X										
X	X	X				P	IMU Gimbal Angles (deg)	X	X	X										
X	X	X				Y		X	X	X										

P99-LM DEORBIT BURN

						Time from Ignition	N40													
						Velocity to be Gained														
						Velocity Accumulated														
						Time from Ignition	N40													
						Velocity to be Gained														
						Velocity Accumulated														
						X	N85													
						Y Residuals (ft/s)														
						Z														

P30-EXTERNAL ΔV
 CSM Separation & TEI 62

V37 Enter, 30 Enter
 V06 N33 Flashing, Load Desired GETI
 V06 N81 Flashing, Load Desired ΔV

						Purpose														
						Prop/Guidance														
+						Weight (lb)	N47	+												
	0	0				P _{Trim}	N48		0	0										
	0	0				Y _{Trim}	(degrees)		0	0										
+	0	0				Hours	N33	+	0	0										
+	0	0	0			Minutes	GETI	+	0	0	0									
+	0					Seconds		+	0											
						ΔV _X	N81													
						ΔV _Y	LV													
						ΔV _Z	(ft/s)													
X	X	X				R		X	X	X										
X	X	X				P	IMU Gimbal Angles (deg)	X	X	X										
X	X	X				Y		X	X	X										
+						H _A pogee	N44	+												
						H _P erigee	nmi													
+						ΔVT (ft/s)		+												
X	X	X				BT (min:s)		X	X	X										
X						ΔVC (ft/s)		X												
X	X	X	X			SXT Star		X	X	X	X									
+						SFT (degrees)		+											0	
+						TRN (degrees)		+											0	0
X	X	X				BSS (Coas Star)		X	X	X										
X	X					SPA (Coas Pitch, deg)		X	X											
X	X	X				SXP (Coas X Pos, deg)		X	X	X										
	0					LAT	N61		0											
						LONG	(degrees)													
+						RTGO (nmi) EMS		+												
+						VIO (ft/s)		+												
						GET 0.05 g Hr:min:s														
						SET STARS														
X	X	X				RAlign		X	X	X										
X	X	X				PAlign		X	X	X										
X	X	X				YAlign		X	X	X										
						ULLAGE														

NOTES:

LUNAR ORBIT PLANE CHANGE NO. 2

EVENT	BT/ ΔV	G. E. T.	PROPULSION/ GUIDANCE	PRETHRUST TARGETING
LOPC-2 (OUT-OF-PLANE)	15.8/282.5	193:13:46.2	SPS/ G&N EXT ΔV (P-40)	P-30
	ΔV_x N65		+ x x	h
	ΔV_y RESIDUALS (ft/s)		+ x x x	min GET
	ΔV_z (BODY AXIS)		+ x	s
	----- V_{x_TRIM} ----- V_{y_TRIM} ----- V_{z_TRIM} (ft/s)			

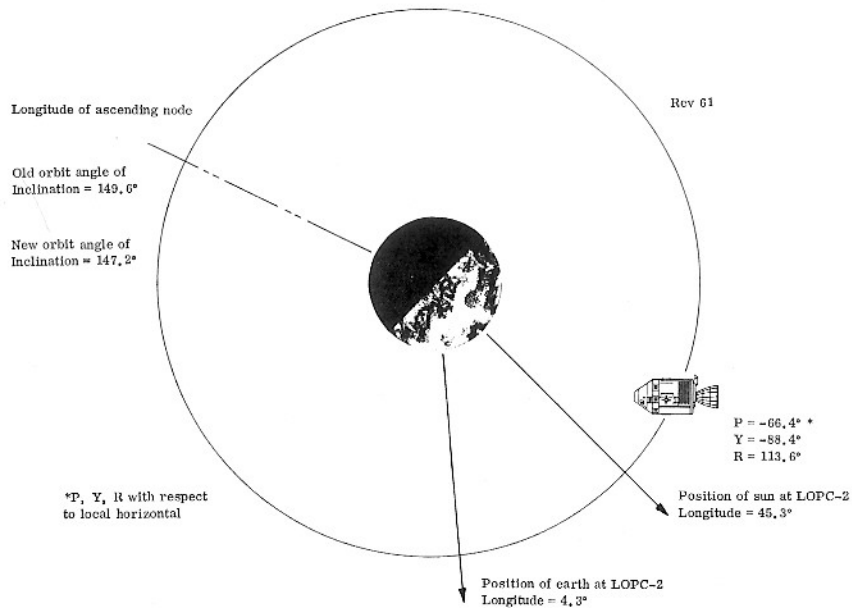

P30-EXTERNAL ΔV
TEI 72 & TEI 74

V37 Enter, 30 Enter

V06 N33 Flashing, Load Desired GET1

V06 N81 Flashing, Load Desired ΔV

				Purpose							
				Prop/Guidance							
				Weight (lb)	N47						
+				PTrim	N48	0	0				
	0	0		YTrim (degrees)		0	0				
+	0	0		Hours	N33	+	0	0			
+	0	0	0	Minutes GET1		+	0	0	0		
+	0			Seconds		+	0				
				ΔV_x	N81						
				ΔV_y LV							
				ΔV_z (ft/s)							
X	X	X		R		X	X	X			
X	X	X		P IMU Gimbal Angles (deg)		X	X	X			
X	X	X		Y		X	X	X			
+				HApogee nmi	N44	+					
				HPerigee							
+				ΔVT (ft/s)		+					
X	X	X		BT (min:s)		X	X	X			
X				ΔVC (ft/s)		X					
X	X	X	X	SXT Star		X	X	X	X		
+			0	SFT (degrees)		+				0	
+			0 0	TRN (degrees)		+				0 0	
X	X	X		BSS (Coas Star)		X	X	X			
X	X			SPA (Coas Pitch, deg)		X	X				
X	X	X		SXP (Coas X Pos, deg)		X	X	X			
	0			LAT (degrees)	N61	0					
				LONG							
+				RTGO (nmi) EMS		+					
+				VIO (ft/s)		+					
				GET 0.05 g Hr:min:s							
SET STARS											
X	X	X		RAlign		X	X	X			
X	X	X		PAlign		X	X	X			
X	X	X		YAlign		X	X	X			
ULLAGE											

NOTES:

SHAPING

EVENT	BT / ΔV	G. E. T.	PROPULSION/ GUIDANCE	PRETHRUST TARGETING
SHAPING	2. 2/ 38. 0	21 0; 49; 11. 7	SPS/ G&N EXT ΔV (P-40)	P-30
	ΔV _x N85		+ x x x	h
	ΔV _y RESIDUALS (ft/s)		+ x x x	min GET
	ΔV _z (BODY AXIS)		+ x	s
----- V _x TRIM ----- V _y TRIM ----- V _z TRIM (ft/s)				

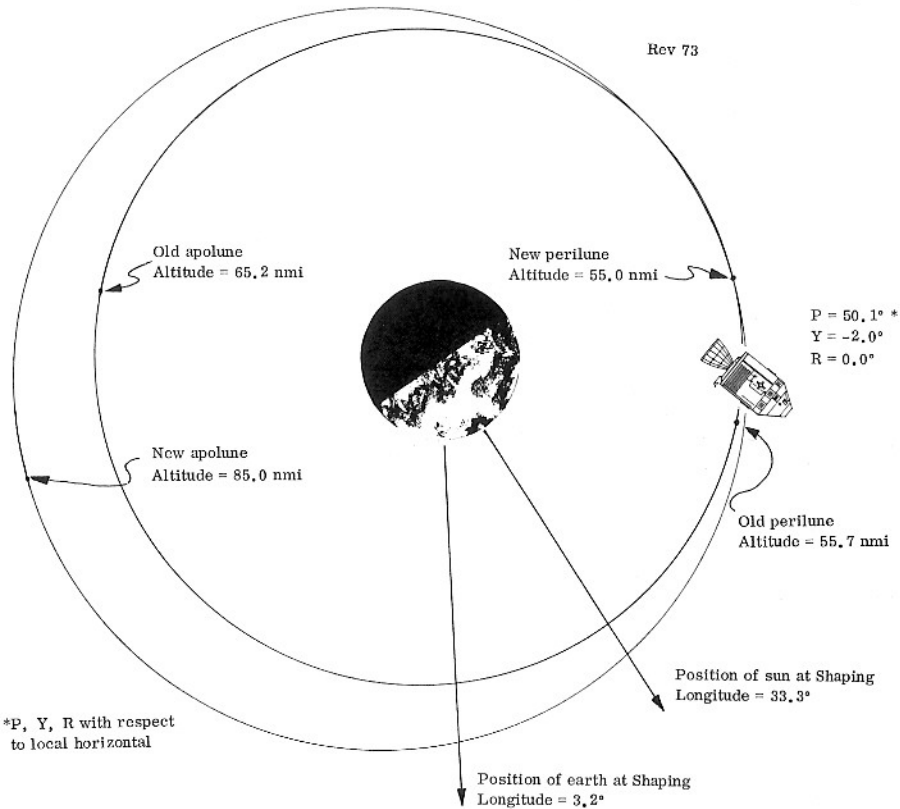

*P, Y, R with respect to local horizontal

P30-EXTERNAL ΔV
TEI 75 (Preliminary) & TEI 75

V37 Enter, 30 Enter

V06 N33 Flashing, Load Desired GETI

V06 N81 Flashing, Load Desired ΔV

				Purpose					
				Prop/Guidance					
				Weight (lb)	N47				
				PTrim (degrees)	N48				
				Y Trim (degrees)					
				Hours	N33				
				Minutes	GETI				
				Seconds					
				ΔV _x	N81				
				ΔV _y LV					
				ΔV _z (ft/s)					
X X X				R		X X X			
X X X				P IMU Gimbal Angles (deg)		X X X			
X X X				Y		X X X			
				H _{Apogee} nmi	N44				
				H _{Perigee}					
				ΔVT (ft/s)					
X X X				BT (min:s)		X X X			
X				ΔVC (ft/s)		X			
X X X X				SXT Star		X X X X			
				SFT (degrees)		+ 0			
				TRN (degrees)		+ 0 0			
X X X				BSS (Coas Star)		X X X			
X X				SPA (Coas Pitch, deg)		X X			
X X X				SXP (Coas X Pos, deg)		X X X			
0				LAT (degrees)	N61	0			
				LONG					
				RTGO (nmi) EMS		+			
				VIO (ft/s)		+			
				GET 0.05 g Hr:min:s					
				SET STARS					
X X X				RAlign		X X X			
X X X				PAlign		X X X			
X X X				YAlign		X X X			
				ULLAGE					

NOTES:

P30-EXTERNAL ΔV

TEI 76

V37 Enter, 30 Enter

V06 N33 Flashing, Load Desired GETI

V06 N81 Flashing, Load Desired ΔV

Purpose Prop/Guidance											
+		Weight (lb)	N47	+							
	0 0	P _{Trim}	N48		0	0					
	0 0	Y _{Trim} (degrees)			0	0					
+	0 0	Hours	N33	+	0	0					
+	0 0 0 0	Minutes GETI		+	0	0	0	0			
+	0	Seconds		+	0						
		ΔV _X	N81								
		ΔV _Y LV									
		ΔV _Z (ft/s)									
X	X X X	R		X	X	X					
X	X X X	P IMU Gimbal Angles (deg)		X	X	X					
X	X X X	Y		X	X	X					
+		H _{Apogee} nmi	N44	+							
+		H _{Perigee}									
+		ΔVT (ft/s)		+							
X	X X X	BT (min:s)		X	X	X					
X		ΔVC (ft/s)		X							
X	X X X X	SXT Star		X	X	X	X				
+		SFT (degrees)		+					0		
+		TRN (degrees)		+					0	0	
X	X X X	BSS (Coas Star)		X	X	X					
X	X X	SPA (Coas Pitch, deg)		X	X						
X	X X X	SXP (Coas X Pos, deg)		X	X	X					
	0	LAT (degrees)	N61		0						
		LONG									
+		RTGO (nmi) EMS		+							
+		VIO (ft/s)		+							
		GET 0.05 g Hr:min:s									
SET STARS											
X	X X X	RAlign		X	X	X					
X	X X X	PAlign		X	X	X					
X	X X X	YAlign		X	X	X					
ULLAGE											

NOTES:

TRANSEARTH INJECTION

EVENT	BT/ΔV	G. E. T.	PROPULSION/GUIDANCE	PRETHRUST TARGETING
TEI (POSTGRADE)	150.5/3212.2	222:20:32.8	SPS/G&N EXT ΔV (P-40)	P-30
	ΔV _X N85		+ x x	h
	ΔV _Y RESIDUALS (ft/s)		+ x x x	min GET
	ΔV _Z (BODY AXIS)		+ x	s

TEI Burn Initiation
 Altitude = 65.7 nmi
 Velocity = 5339.3 ft/s
 Longitude = 179.7°
 Latitude = 10.3°

TEI Cutoff
 Altitude = 67.3 nmi
 Velocity = 8521.2 ft/s
 Longitude = 170.0°
 Latitude = 11.9°
 Plane Change = 3.3°
 Burn Arc = 9.7°

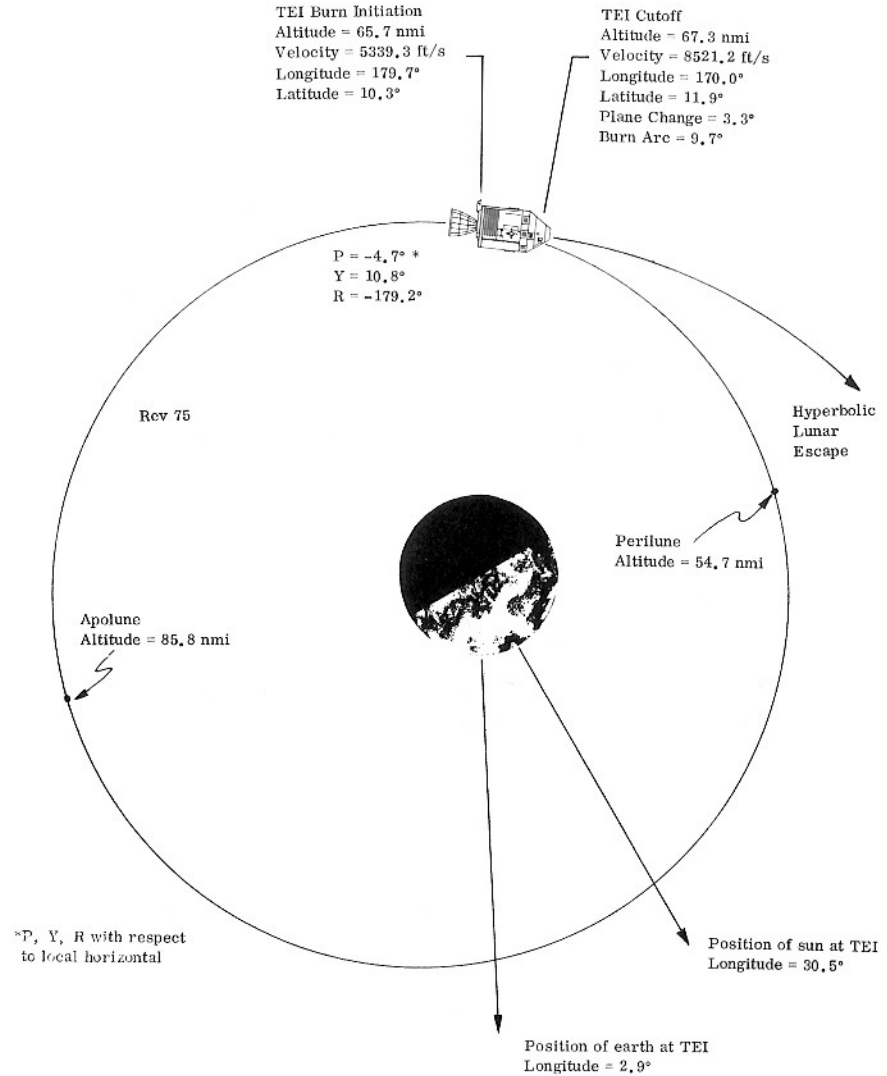

*P, Y, R with respect to local horizontal

ENTRY

P61

V37 Enter, 61 Enter
 V06 N61 Flashing
 V06 N60 Flashing, Record
 V06 N63 Flashing, Used for EMS if no Communication

P62

V50 N25 Flashing, Request CM/SM Separation
 V06 N61 Flashing
 V06 N22, Monitor

P63

V06 N64, Monitor

					Area														
X	X	X			R 0.05 g	X	X	X											
X	X	X			P 0.05 g	X	X	X											
X	X	X			Y 0.05 g	X	X	X											
					GET Hor Ck														
X	X	X			P EI-17	X	X	X											
	0				Lat N61	0													
					Long														
X	X	X			Max g	X	X	X											
+					V400K N60	+													
-	0	0			γ400K	-	0	0											
+					RTGO EMS	+													
+					VIO	+													
					RTT														
X	X				RET 0.05 g	X	X												
+	0	0			D _L Max N69	+	0	0											
+	0	0			D _L Min	+	0	0											
+					V _L Max	+													
+					V _L Min	+													
X	X	X			D _O	X	X	X											
X	X				RET V _{Circ}	X	X												
X	X				RETBBO	X	X												
X	X				RETEBO	X	X												
X	X				RETDRO	X	X												
X	X	X	X		SXTS	X	X	X	X										
+				0	SFT EI-2	+												0	
+				0 0	TRN	+												0 0	
X	X	X			BSS	X	X	X											
X	X				SPA EI-2	X	X												
X	X	X			SXP	X	X	X											
X	X	X	X		Lift Vector	X	X	X	X										

P47-THRUST MONITOR

V37 Enter, 47 Enter

V16 N83 Flashing, ΔV XYZ Body Axes

N62 Enter

V16 N62 Flashing, Inertial Velocity, Altitude Rate, Altitude

X	X	X				R		X	X	X									
X	X	X				P IMU Gimbal Angles (degrees)		X	X	X									
X	X	X				Y		X	X	X									
X	X	X				BT (min:s)		X	X	X									
						VI (ft/s)													
						X N83													
						Y ΔV ft/s													
						Z													
						V ft/s N62													
						HDOT ft/s													
						H nmi													

NOTES:

APOLLO EARTH ENTRY

Aerodynamic Forces

The earth entry trajectory is shaped by the forces of gravity and atmospheric flow over the spacecraft surface. The latter force has two components, lift and drag.

Drag is a force directed opposite to the relative velocity vector and equal to:

$$\bar{D} = \frac{1}{2} \frac{SC_D}{M} \rho v^2 \bar{T}_D (\text{ft/s}^2)$$

Lift is a force perpendicular to the relative velocity vector and equal to:

$$\bar{L} = \frac{1}{2} \frac{SC_L}{M} \rho v^2 \bar{T}_L (\text{ft/s}^2)$$

where,

- ρ = Atmospheric density (slugs/ft³)⁽¹⁾
- v = Relative velocity magnitude (ft/s)
- C_D = Coefficient of drag (unitless)
- C_L = Coefficient of lift (unitless)
- M = Mass of spacecraft (slugs)
- S = Surface area presented to atmospheric flow (ft²)

Aerodynamic lift (or C_L) is a consequence of the vehicle center-of-mass (CM)⁽²⁾ being offset from its axis of symmetry. With the relative velocity vector along the axis of symmetry, the resulting symmetrical pressure distribution produces a resultant force (\bar{F}) through the center-of-pressure (CP)⁽³⁾. The component of this force (\bar{F}_1) perpendicular to the line joining the CP and CM causes a torque about the CM. The spacecraft will rotate about the CM until a stable attitude is reached where the force \bar{F} is fully along the line joining the CM and CP.

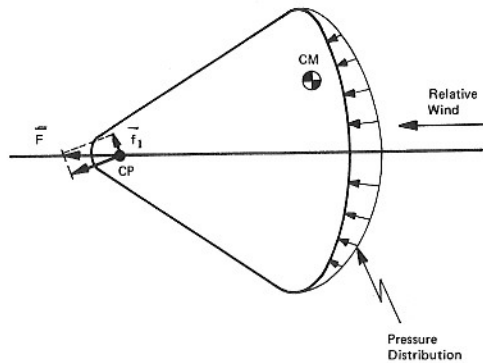
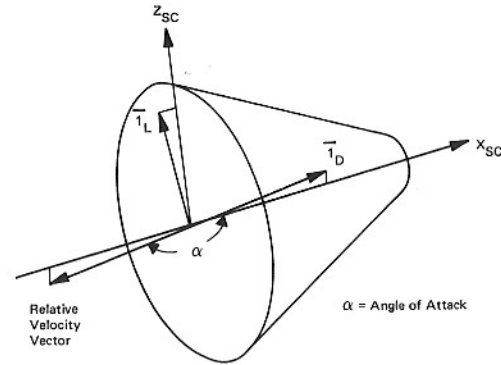

Notes:

1. A slug is a constant, relating units in the equation $F(\text{pound-force}) = M(\text{slugs}) \times a(\text{ft/s}^2)$
2. Center-of-mass: The point where the mass of a body may be regarded as being concentrated, insofar as motion of translation is concerned.
3. Center-of-pressure: The point where the resultant of all aerodynamic forces apparently operates.

In this stable attitude, the component of \bar{F} perpendicular to the relative velocity vector produces lift. Because of the spherical shape of the heat shield, the stable attitude remains relatively unchanged throughout the entry phases.

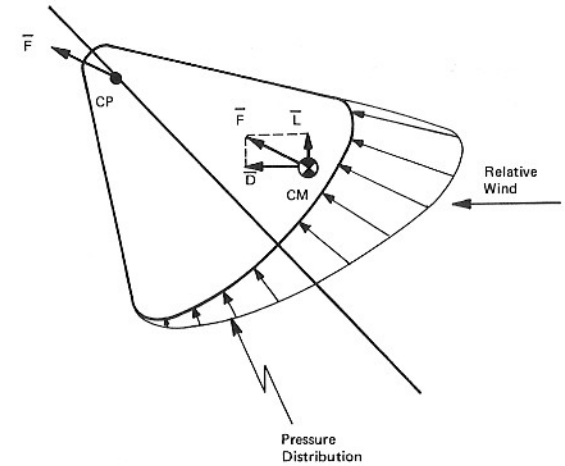
Lift Modulated Entry

During earth entry, steering is accomplished by orienting the lift vector (\bar{L}) so that the resulting specific forces satisfy the entry guidance objectives. The lift vector is rotated about the Roll Stability Axis according to roll commands issued by the AGC.

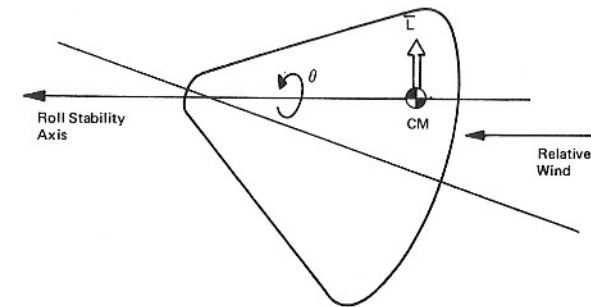

A roll angle (θ) of 0 degrees causes the lift vector to be up along the vertical and produces maximum downrange flight. A roll angle of ± 90 degrees puts the lift vector in the local horizontal plane, producing maximum crossrange (or lateral) flight.

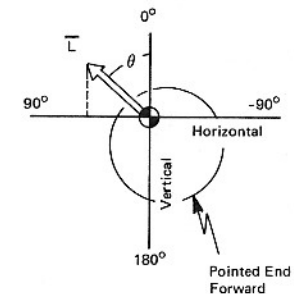

The entry control programs are designed to calculate the roll angle (θ) which will produce the vertical component of lift necessary to satisfy a guidance objective (constant drag flight, downrange target acquisition, and so forth). Crossrange control is maintained by choosing the proper sign of roll angle in order to reduce lateral errors.

Lift modulated flight can significantly reduce the peak accelerations experienced during entry, as shown below.

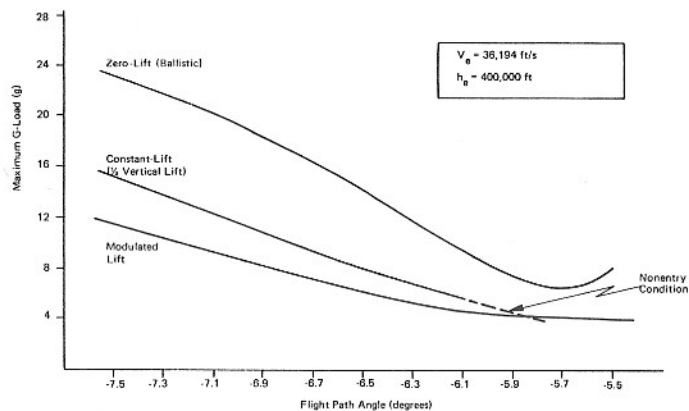

The maneuver footprint for a GNCS-controlled entry utilizing modulated lift is approximately 2,500 nautical miles in downrange and 250 nautical miles in crossrange. A typical entry footprint for a lunar return mission is shown below. A backup control procedure – the EMS ranging technique – defines the maximum range limit of 3,500 nautical miles.

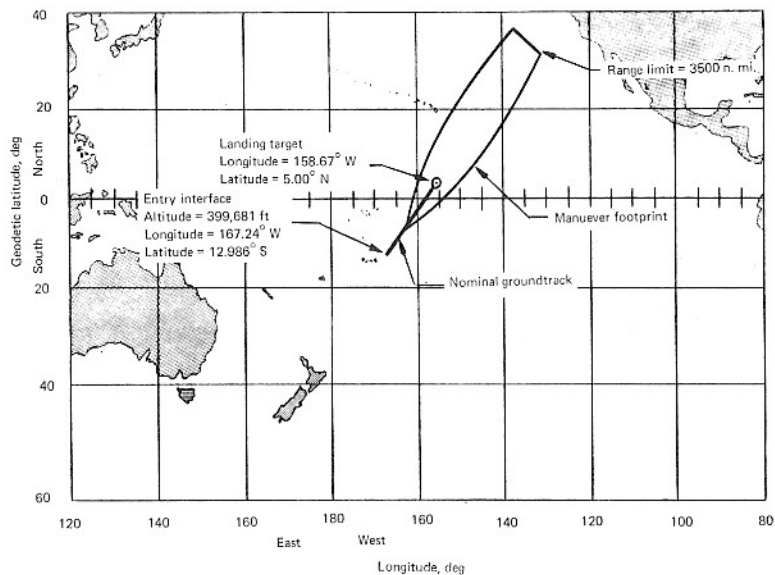

Entry Control Equations

The entry guidance equations are solved every 2 seconds in the AGC. Navigation and autopilot functions are also performed during this computation cycle.

The guidance equations below are used during the entry phases associated with a nominal lunar return entry. Equation I (targeting) is executed every pass through the computation loop. Equations II and III are executed during their particular entry phases for downrange steering. Lateral steering is done by Equation IV dependent upon certain logic constraints in the AGC. The roll angle needed to meet the above equations is calculated using Equation V.

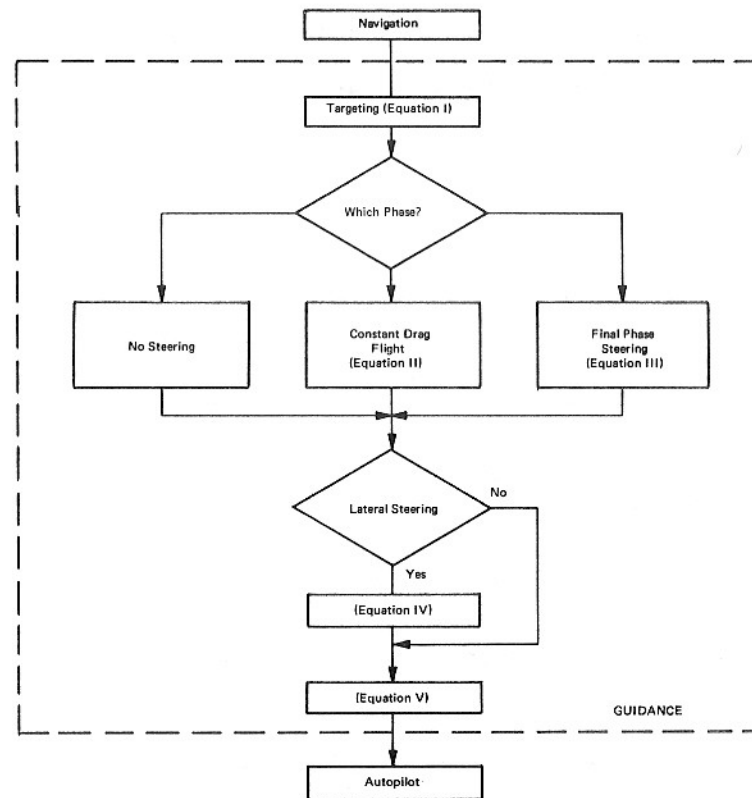

Equation I: Landing Point Targeting Equations

During the early entry phases, a unit vector is calculated which points from the earth's center to an estimated splash point. This initial target vector (\vec{T}_{RT0}), together with unit vectors in the equatorial plane directed easterly (\vec{T}_{RTE}) and in the target meridian (\vec{T}_{RTN}), is used as a reference from which a new target vector (\vec{T}_{RT}) is calculated based on an updated estimate of time-to-splash.

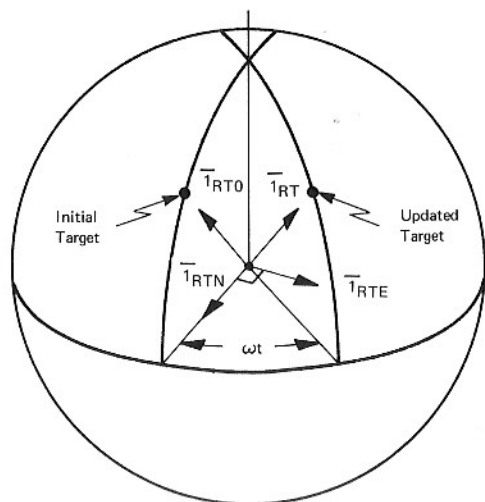

$$\vec{1}_{RT} = \vec{1}_{RTO} + \vec{1}_{RTN} [\cos(\omega t) - 1] + \vec{1}_{RTE} \sin(\omega t)$$

where (ωt) is the amount of earth's rotation for the difference between the old and new estimate of time-to-splash.

Based upon the new target vector $(\vec{1}_{RT})$, the downrange angle from the spacecraft to the splash point is computed using:

$$\theta_H = \arccos\{\vec{1}_{RT} \cdot \text{Unit } \vec{R}\} \text{ (radians)}$$

The crossrange error from the present flight plane is calculated as follows:

$$\text{LATANG} = \vec{1}_{RT} \cdot \text{Unit}(\vec{V} \times \vec{R}) \text{ (radians)}$$

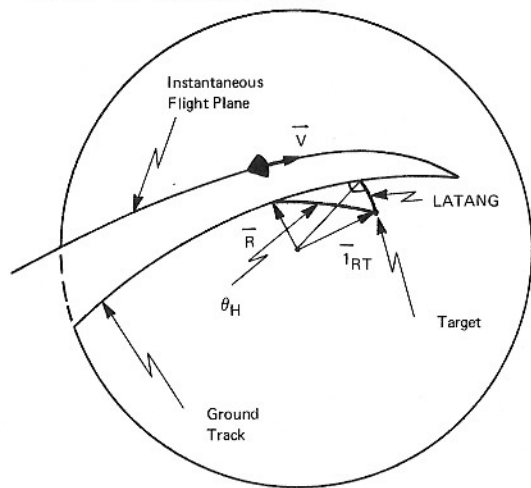

Equation II: Constant-Drag Flight Equation

Reduction of near-parabolic velocities (associated with the lunar return mission) to a point where capture in the earth's atmosphere is assured, is accomplished by flying a constant-drag trajectory.

Constant-drag guidance is achieved using an on-board computed reference trajectory and constant guidance factors for compensation of off-nominal conditions. The control reference parameters are computed using the following constant drag relationships.

$$(L/D)_{\text{Ref}} = -\left(\frac{V^2}{R} - g\right) \frac{1}{D_0} \text{ (unitless)}$$

$$\dot{R}_{\text{Ref}} = \frac{2D_0}{\beta V} \text{ (ft/s)}$$

$$D_{\text{Ref}} = D_0 \text{ (ft/s}^2\text{)}$$

where

V = velocity (ft/s)

R = radial distance (ft)

g = gravity (ft/s²)

D_0 = desired drag level (ft/s²)

β = constant associated with atmosphere ($\frac{1}{\text{ft}}$)

Gain factors were chosen which relate perturbations in drag and altitude rate to the reference L/D.

$$(L/D)_{\text{control}} = (L/D)_{\text{Ref}} + 0.01 (D - D_{\text{Ref}}) - 0.002 (\dot{R} - \dot{R}_{\text{Ref}})$$

Equation III: Final Phase Equation

Steering through the denser portions of atmosphere is accomplished using a terminal control method of guidance. A mean terminal glide trajectory is prestored into the AGC. Linear perturbation coefficients, used to adjust for deviations in flight parameters from nominal values, are also stored. Using velocity as the independent variable, the various quantities in storage are chosen which are used in the basic control equation:

$$(L/D)_{\text{control}} = (L/D)_{\text{Ref}} + K_1 \{(R - R_{\text{Ref}}) + K_2 (D - D_{\text{Ref}}) + K_3 (\dot{R} - \dot{R}_{\text{Ref}})\}$$

where

$(L/D)_{\text{Ref}}$ = constant value (≈ 0.27)

R_{Ref} = reference range-to-go (radians)

D_{Ref} = reference drag (ft/s²)

\dot{R}_{Ref} = reference altitude rate (ft/s)

K_1 = sensitivity of L/D to deviations in range (unitless)

K_2 = sensitivity of range to deviations in drag level (radians/ft/s²)

K_3 = sensitivity of range to deviations in altitude rate (radians/ft/s)

Equation IV: Crossrange (or Lateral) Control

Crossrange control is maintained only when the lateral error (LATANG) is in excess of a computed deadband limit. This limit (somewhat less than the crossrange capability of the spacecraft) is computed every 2 seconds as a function of spacecraft velocity.

When this limit is exceeded the sign of the commanded roll angle (K2ROLL) is changed so that the horizontal component of lift causes the spacecraft to steer laterally toward the target.

Equation V: Commanded Roll Angle Equation

Using previously determined quantities (K2ROLL and L/D_{control}) the commanded roll angle is calculated by

$$\text{ROLLC} = (\text{K2ROLL}) \arccos \left[\frac{L/D_{\text{control}}}{L/D_{\text{Ref}}} \right] \quad (\text{degrees})$$

where

$$L/D_{\text{Ref}} \approx 0.3 \text{ (unitless)}$$

Entry Control Programs

The guidance function, which incorporates the entry control equations previously described together with certain logic decisions, can be considered as a basic set of AGC software programs (P60's). The programs are associated with various phases of the entry profile as described below.

P61 – Entry Preparation Program

- Purpose: Start navigation, check IMU alignment, and provide EMS initialization data in case of communications failures.
- Initiation: Astronaut keys DSKY – V37E 61E
- Steering: None, lift vector is oriented full-up (0 degrees) or full-down (180 degrees), according to the astronaut specifications.
- DSKY Displays:

V06N61

R1 – Impact latitude	Latitude of splash point
R2 – Impact longitude	Longitude of splash point
R3 – Heads up/down	±1

V06N60

R1 – G max	Maximum predicted g-load
R2 – V predicted	Predicted velocity at EI (400 K ft)
R3 – γ_{EI}	Predicted entry angle at EI

V06N63

R1 – RTOGO	Range-to-go from 290,626-foot altitude
R2 – V_{io}	Predicted velocity at 290,626-foot altitude
R3 – T_{fe}	Time to 290,626-foot altitude

P62 – CM/SM Separation and Preentry Maneuver Program

- Purpose: Notifies crew when GNCS is prepared for CM/SM separation. Also orients the spacecraft to the entry attitude.
- Initiation: P62 entered when P61 completed and the astronaut keys PROCEED after final P61 display.
- Steering: None, lift vector orientation maintained.
- DSKY Displays:

V50N25

R1 – 00041	Request to separate CM/SM
R2	Blank
R3	Blank

V06N61

R1 – Impact latitude
R2 – Impact longitude
R3 – Heads up/down

V06N22

R1 – AOG	} Desired final gimbal angles at EI
R2 – AIG	
R3 – AMG	

P63 – Entry Control Initialization Program

- Purpose: Initializes the entry targeting and guidance equations.
- Initiation: P63 entered automatically when P62 achieves the entry attitude.
- Steering: None, lift vector orientation maintained.
- DSKY Displays:

V06N64

R1 – G	Present g-load
R2 – V_i	Present velocity
R3 – RTOGO	Range to the target

P64 – Post 0.05 g Program

- Purpose: Perform initial steering while awaiting subsequent phases.
- Initiation: P64 is entered automatically when 0.05 g is sensed by the GNCS.
- Steering:

When 0.05 g is sensed, a calculation is made to determine position of spacecraft in the entry corridor, and the lift vector is positioned full-up or full-down accordingly. The orientation is maintained until a precomputed drag level is exceeded (somewhat less than 1.5 g).

A constant drag trajectory is flown (≈ 4 g) until the altitude rate becomes greater (more positive) than -700 ft/s.

Range-to-go checks are made to determine whether the available range will permit a controlled skip maneuver. Because the nominal range-to-target at EI is 1,250 nmi, this requirement is never satisfied and the constant-drag flight is continued.

A predicted exit velocity for the hypothetical skip maneuver will decrease below 18,000 ft/s and exit is made to the final phase.

d. DSKY Displays

V06N74

R1 - BETA	Commanded roll
R2 - V_i	Inertial velocity
R3 - G	Present g-load

P67 - Final Phase Program

- Purpose: Steer through the dense portion of atmosphere and achieve the planned splash point.
- Initiation: P67 is entered automatically from P64 for the nominal lunar return entry.
- Steering: Steering is done using a terminal type controller based on a prestored nominal trajectory.

Guidance is terminated when velocity drops below 1,000 ft/s.

d. DSKY Displays:

V06N66

R1 - BETA	Commanded roll angle
R2 - XNRGERR	Crossrange error
R3 - DWRNGER	Downrange error

V16N67

R1 - RTOGO	Range to target
R2 - LAT	Present latitude
R3 - LONG	Present longitude

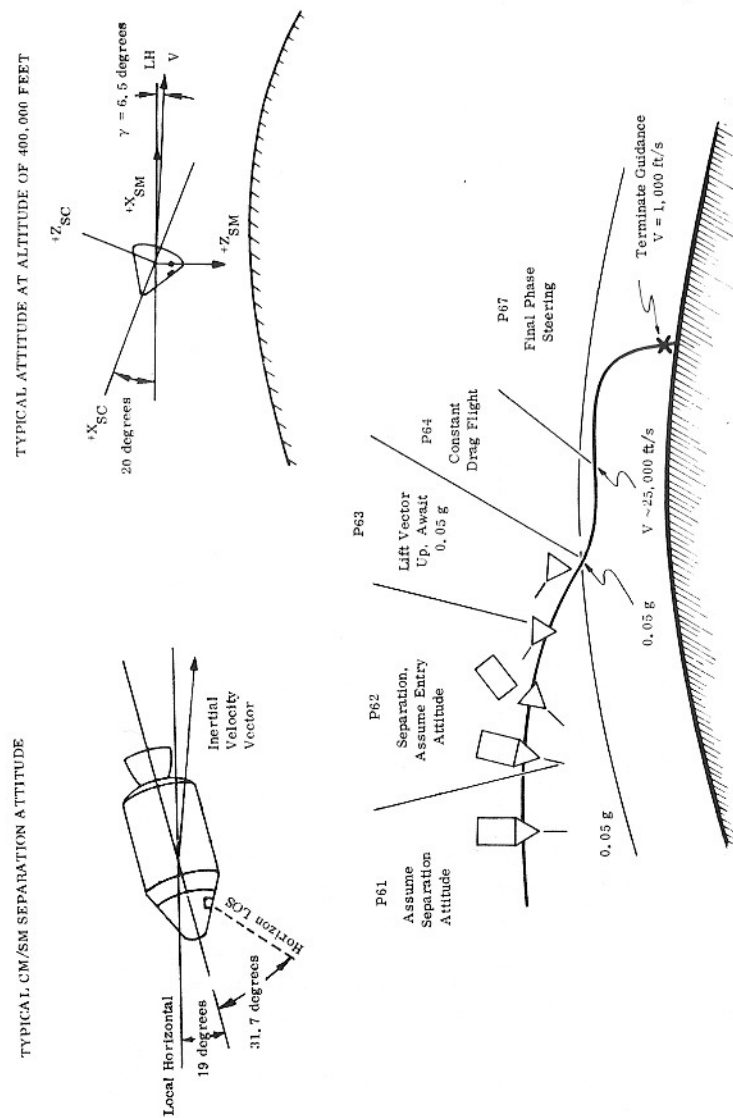

APOLLO MISSION SPLASH POINT SUMMARY

Mission	Planned Target		Final DSKY Reading		Total DSKY Error Nmi Δ	Ship Splash Report		Total Ship Recovery Reported Error Nmi	Best-Estimate Trajectory (BET) Report		Total (official) Error Nmi	Remarks
	North Lat	West Long	North Lat	West Long		North Lat	West Long		North Lat	West Long		
Apollo 7	27.61	64.17	27.63	64.18	1.3	27.54	64.07	7.3	27.64	64.15	2.1	Earth Orbital
Apollo 8	8.13	165.03	8.10	165.01	2.1	8.12	165.02	0.9	8.1	165.01	2.3	Lunar Return
Apollo 9	23.25	68.00	23.26	68.01	0.8	23.21	67.94	4.3	23.22	67.98	2.1	Earth Orbital
Apollo 10	-15.07	164.67	-15.07	164.65	1.2	-15.03	164.65	2.7	-15.06	164.65	1.3	Lunar Return
Apollo 11	-13.25	169.15	-13.30	169.15	1.2	-13.25	169.15	4.2	*	*	1.0*	Lunar Return
Apollo 12	-15.81	165.17	-15.87	165.16	3.6	-15.78	165.15	2.2	-15.83	165.17	1.1	Lunar Return
Apollo 13	-21.66	165.37	-21.64	165.38	1.3	-21.64	165.36	3.9	-21.64	165.36	1.0	Lunar Return
Apollo 14	-27.02	172.65	-27.02	172.65	0	-27.00	172.659	1.3	-27.01	172.66	.62	Lunar Return
Apollo 15	-26.13	158.13	-26.13	158.13	0	-26.125	158.15	1.5**	-26.13	158.14	.63	Lunar Return

* Onboard data lost during entry - miss distance is best estimate

** Ship Report based on Nav Satellite Fix

P61

- V37 Enter, 61 Enter
- V06 N61 Flashing
- V06 N60 Flashing, Record
- V06 N63 Flashing, Used for EMS if no Communication

P62

- V50 N25 Flashing, Request CM/SM Separation
- V06 N61 Flashing
- V06 N22, Monitor

P63

- V06 N64, Monitor

				Area			
X	X	X		R 0.05 g	X	X	X
X	X	X		P 0.05 g	X	X	X
X	X	X		Y 0.05 g	X	X	X
				GET Hor Ck			
X	X	X		P EI-17	X	X	X
	0			Lat N61	0		
				Long			
X	X	X		Max g	X	X	X
+				V400K N60	+		
0	0			7400K	-	0	0
+				RTGO EMS	+		
+				VIO	+		
				RTT			
X	X			RET 0.05 g	X	X	
+	0	0		D _L Max N69	+	0	0
+	0	0		D _L Min	+	0	0
+				V _L Max	+		
+				V _L Min	+		
X	X	X		D _O	X	X	X
X	X			RET V _{Circ}	X	X	
X	X			RETBBO	X	X	
X	X			RETEBO	X	X	
X	X			RETDRO	X	X	
X	X	X	X	SXTS	X	X	X
+			0	SFT EI-2	+		0
+			0	TRN	+		0
X	X	X		BSS	X	X	X
X	X			SPA EI-2	X	X	
X	X	X		SXP	X	X	X
X	X	X	X	Lift Vector	X	X	X

AREA	XXX	Splashdown Area Defined by Target Line.
R .05G	XXX (deg)	Spacecraft IMU Gimbal Angles Required for Aerodynamic Trim at 0.05 g
P .05G	XXX (deg)	
Y .05G	XXX (deg)	
GET (HOR CK)	XX:XX:XX (h:min:s)	Time of Entry Attitude Horizon Check at EI -17 Minutes.
P (HOR CK)	XXX (deg)	Pitch Attitude for Horizon Check at EI -17 Minutes.
LAT	±XX.XX (deg)	Latitude of Target Point.
LONG	±XXX.XX (deg)	Longitude of Target Point.
MAX G	XX.X (g)	Predicted Maximum Reentry Acceleration.
V400K	XXXXX (ft/s)	Inertial Velocity at Entry Interface.
γ400K	X.XX (deg)	Inertial Flight Path Angle at Entry Interface.
RTGO	XXXX.X (nmi)	Range to Go from 0.05 g to Target for EMS Initialization.
VIO	XXXXX. (ft/s)	Inertial Velocity at 0.05 g for EMS Initialization.
RRT	XX:XX:XX (h:min:s)	Reentry Reference Time Based on GET of Predicted 400K (DET Start).
RET .05G	XX:XX (min:s)	Time of 0.05 g from 400K (RRT).
D _L MAX	X.XX (g)	Maximum Acceptable Value of Predicted Drag Level (from CMC).
D _L MIN	X.XX (g)	Minimum Acceptable Value of Predicted Drag Level (from CMC).
V _L MAX	XXXXX (ft/s)	Maximum Acceptable Value of Exit Velocity (from CMC).
V _L MIN	XXXXX (ft/s)	Minimum Acceptable Value of Exit Velocity (from CMC).
DO	X.XX (g)	Planned Drag Level During Constant g.
RET V _{CIRC}	XX:XX (min:s)	Time from EI that S/C Velocity Becomes Circular.
RETBBO	XX:XX (min:s)	Time from EI to the Beginning of Blackout.
RETEBO	XX:XX (min:s)	Time from EI to the End of Blackout.
RETDRO	XX:XX (min:s)	Time from EI to Drogue Deployment.
SXTS	XX (octal)	Sextant Star for Entry Attitude Check.
SFT	XXX.X (deg)	Sextant Shaft Setting for Entry Attitude Check.
TRN	XX.X (deg)	Sextant Trunnion Setting for Entry Attitude Check.
BSS	XXX (octal)	Boresight Star for Entry Attitude Check Using the COAS.
SPA	XX.X (deg)	BSS Pitch Angle on COAS.
SXP	X.X (deg)	BSS X Position on COAS.
LIFT VECTOR	XX	Lift Vector Desired at 0.05 g Based on Entry Corridor.