

FM 23-10

MHI  
Copy 3

W. E. BENEDICT

WAR DEPARTMENT

**BASIC FIELD MANUAL**



**U. S. RIFLE, CALIBER .30, M1903**

**FM 23-10**

**BASIC FIELD MANUAL**



**U. S. RIFLE, CALIBER .30, M1903**

---

**Prepared under direction of the  
Chief of Infantry**



**UNITED STATES  
GOVERNMENT PRINTING OFFICE  
WASHINGTON : 1940**

---

**For sale by the Superintendent of Documents, Washington, D. C.  
Price 25 cents**

WAR DEPARTMENT,  
WASHINGTON, *January 2, 1940.*

FM 23-10, Basic Field Manual, U. S. Rifle, Caliber .30, M1903, is published for the information and guidance of all concerned.

[A. G. 062.11 (9-14-39).]

BY ORDER OF THE SECRETARY OF WAR:

G. C. MARSHALL,  
*Chief of Staff.*

Official:

E. S. ADAMS,  
*Major General,*  
*The Adjutant General.*

## TABLE OF CONTENTS

	Paragraphs	Pages
<b>CHAPTER 1. MECHANICAL TRAINING:</b>		
Section I. Description .....	1-5	1-4
II. Care and cleaning .....	6-12	4-10
III. Functioning .....	13	10-12
IV. Individual safety precautions .....	14	12
V. Instruments .....	15	13-15
<b>CHAPTER 2. MARKSMANSHIP—KNOWN - DISTANCE TARGETS:</b>		
Section I. General .....	16-23	16-19
II. Preparatory marksmanship training .....	24-31	19-64
III. Qualification courses .....	32-36	64-71
IV. Range practice .....	37-39	71-91
V. Equipment; known-distance targets and ranges, and range precautions .....	40-43	92-101
VI. Small-bore practice .....	44-47	101-106
<b>CHAPTER 3. MARKSMANSHIP—MOVING GROUND TARGETS:</b>		
SECTION I. General .....	48-49	107-108
II. Moving vehicles .....	50-52	108-109
III. Moving personnel .....	53-54	109-110
IV. Moving targets, ranges, and safety precautions .....	55-56	110-112
<b>CHAPTER 4. MARKSMANSHIP—AIR TARGETS:</b>		
Section I. Nature of air targets for rifle .....	57-58	113
II. Technique of fire .....	59-63	114-117
III. Antiaircraft marksmanship .....	64-68	117-126
IV. Miniature range practice .....	69-72	127-130
V. Towed-target firing .....	73-77	130-133
VI. Ranges, targets, and equipment ..	78-83	133-142
<b>CHAPTER 5. TECHNIQUE OF RIFLE FIRE:</b>		
Section I. General .....	84-86	143-144
II. Range estimation .....	87-91	144-148
III. Target designation .....	92-98	148-156
IV. Rifle fire and its effect .....	99-105	156-159
V. Application of fire .....	106-113	159-165
VI. Landscape-target firing .....	114-121	165-171
VII. Field-target firing .....	122-128	171-176
VIII. Fire exercises .....	129-131	176-179
<b>CHAPTER 6. ADVICE TO INSTRUCTORS:</b>		
Section I. General .....	132	180
II. Mechanical training .....	133	180
III. Marksmanship — known-distance targets .....	134-148	181-198
IV. Marksmanship—air targets .....	149-153	198-204
V. Technique of fire .....	154-160	204-208

	Paragraphs	Pages
APPENDIX I. AMMUNITION:		
General -----	1	209
Classification -----	2	209
Ammunition lot number -----	3	210
Grade -----	4	210
Care, handling, and preservation -----	5	211
Cartridge, ball, caliber .30, M2 and M1 -----	6	211
Precautions in firing blank ammunition -----	7	212
APPENDIX II. List of references -----		213
INDEX -----		215

## BASIC FIELD MANUAL

## U. S. RIFLE, CALIBER .30, M1903

(The matter contained herein supersedes chapter 1, part one, Basic Field Manual, volume III, January 3, 1938; chapter 6, part one, Basic Field Manual, volume III, March 1, 1932 (including C 1, January 2, 1936, and C 2, January 3, 1939); chapter 2, part five, Basic Field Manual, volume III, May 26, 1932; chapter 1, part six, Basic Field Manual, volume III, May 26, 1936; and chapter 2, part six, Basic Field Manual, volume III, July 15, 1937.)

## CHAPTER 1

## MECHANICAL TRAINING

	Paragraphs
SECTION I. Description.....	1-5
II. Care and cleaning.....	6-12
III. Functioning.....	13
IV. Individual safety precautions.....	14
V. Instruments.....	15

## SECTION I

## DESCRIPTION

■ 1. GENERAL.—The United States rifle, caliber .30, M1903, is a breech-loading magazine rifle of the bolt type. It is popularly referred to as the *Springfield rifle*.

■ 2. PRINCIPAL DIMENSIONS, WEIGHTS, AND MISCELLANEOUS DATA.

Weight, without bayonet.....	pounds..	8. 69
Weight, with bayonet.....	do.....	9. 69
Length, without bayonet.....	inches..	43+
Length, with bayonet.....	do.....	59+
Diameter of bore.....	do.....	.30
Trigger pull, minimum.....	pounds..	3. 0
Rifling:		
Number of grooves.....	.....	4
Twist, uniform, right, one turn in.....	inches..	10
Magazine capacity.....	rounds..	5

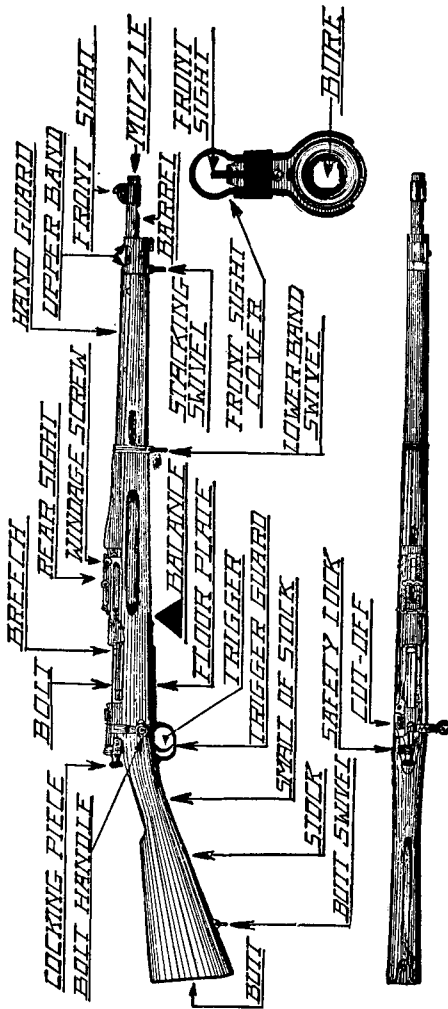

FIGURE 1.—U. S. rifle, caliber .30, M1903.

■ 3. REAR SIGHT.—The rear sight is adjustable for windage, and the drift of the bullet to the right is offset automatically by the construction of the rear sight leaf. The leaf is graduated from 100 to 2,850 yards. The lines extending across one or both branches of the leaf are 100-yard divisions, the longer of the short lines 50-yard and the shorter lines 25-yard divisions. The drift slide, which may be moved

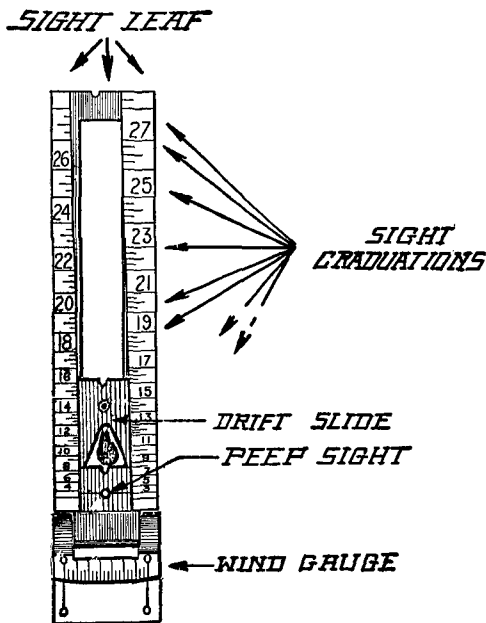

FIGURE 2.—Rear sight.

up or down on the leaf, has notches called open sights and a circular hole called the peep sight. With the leaf raised to the vertical position the lines on either side of the peep sight, and the lower notch, enable the drift slide to be set accurately at any desired graduation on the leaf. With the leaf down and using the *battle sight* notch in the slide cap the sights are set for 547 yards for the down position of the slide.



The rear end of the rear sight movable base is marked with wind-gage graduations, each point of which corresponds to a lateral deviation in the point of impact of the bullet of 4 inches for each 100 yards of range to the target.

■ 4. RATE OF FIRE AND EFFECTIVE RANGE.—The maximum rate of accurate fire with this weapon depends upon the skill and the position of the operator and the visibility of the target. It varies from 10 to 15 shots per minute. The effectiveness of rifle fire during combat decreases as the range to the target increases. Its use at ranges greater than 600 yards is unusual.

■ 5. NOMENCLATURE AND REFERENCES.—*a. Nomenclature.*—The soldier need be familiar with the names of only those parts of the rifle which are frequently referred to in drill and range practice.

*b. References.*—(1) Safety precautions for observance by troops are complete in this manual. References to AR 750-10 are necessary for range officers, the officer in charge of firing, and the commander responsible for the location of ranges and conduct of firing thereon.

(2) See appendix I for data on ammunition for use in the U. S. rifle, caliber .30, M1903.

(3) Other information in regard to the rifle necessary for supply and administrative purposes by company and higher headquarters is found in the references listed in appendix II.

## SECTION II

### CARE AND CLEANING

■ 6. IMPORTANCE.—The care and cleaning of the rifle is an important duty to be performed by all soldiers armed with this weapon, and the subject merits the serious consideration of all officers. Experience has shown that the majority of rifles become unserviceable not through shooting but through the lack of intelligent and proper care. In cleaning, the use of abrasives or other harmful materials is forbidden.

■ 7. INSPECTIONS.—At all inspections, unless otherwise ordered, the rifles will be clean, the bore of the rifle pro-

tected with a thin film of medium rust-preventive compound, the mechanism of the rifle lubricated with thin oil (sperm oil), and the oiler filled with oil. When the inspector wishes to inspect the rifles minutely he may order that all grease and oil be removed from them; but in such cases the grease and oil will be applied again immediately after the inspection, and the inspector should allot a specific time for so doing.

■ 8. DISASSEMBLING FOR CLEANING.—*a. Parts to be removed.*—Only the following parts of the rifle may be removed by the individual soldier for the purpose of cleaning: Front sight cover, floor plate and follower, gun sling, oiler and thong case, and the bolt.

*b. To remove the floor plate and follower.*—Insert the point of a cartridge through the hole in the floor plate and

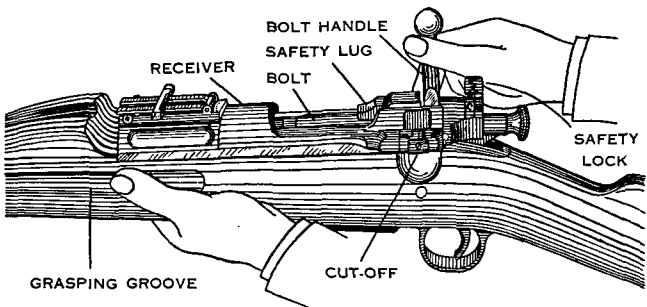

FIGURE 3.

press on the floor plate catch. This releases the floor plate which may then be removed together with the magazine spring and follower. Raise the rear end of the magazine spring high enough to clear the lug on the floor plate and draw it out of its mortise; in the same manner separate the magazine spring from the follower. To assemble, proceed in reverse order.

*c. To remove and disassemble the bolt.*—Place the cut-off at the center notch; cock the piece by raising and lowering the bolt handle; turn the safety lock to the vertical position; raise the bolt handle and draw out the bolt to the rear.

(See fig. 3.) Press the sleeve lock in with the thumb to unlock the sleeve from the bolt; unscrew the sleeve by turning to the left and remove it. (See fig. 4.) Hold the sleeve between the forefinger and thumb of the left hand; draw the cocking piece back slightly with the middle finger and thumb of the right hand; turn the safety lock down to the left with the forefinger of the right hand and allow the cocking piece to move forward in the sleeve. This partially relieves the tension of the mainspring. With the cocking piece against the breast, draw back the firing pin sleeve with the forefinger and thumb of the right hand and

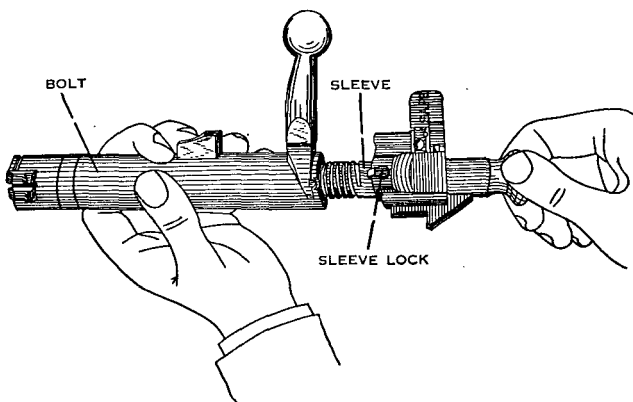

FIGURE 4.

hold it in this position while removing the striker with the left hand. (See fig. 5.) Remove the firing pin and mainspring; pull the firing pin out of the sleeve. Turn the extractor to the right, forcing its tongue out of its groove in the front of the bolt, and force the extractor forward and off the bolt. (See fig. 6.)

*d. To assemble and replace the bolt mechanism.*—Turn the extractor collar until its lug is on line with the safety lug on the bolt; insert the lug on the collar in the undercuts in the extractor by pushing the extractor to the rear until its tongue comes in contact with the face of the bolt; turn the extractor to the right until it is over the right lug; press the hook of

the extractor against some rigid object until the tongue on the extractor enters its groove in the bolt. (See fig. 7.)

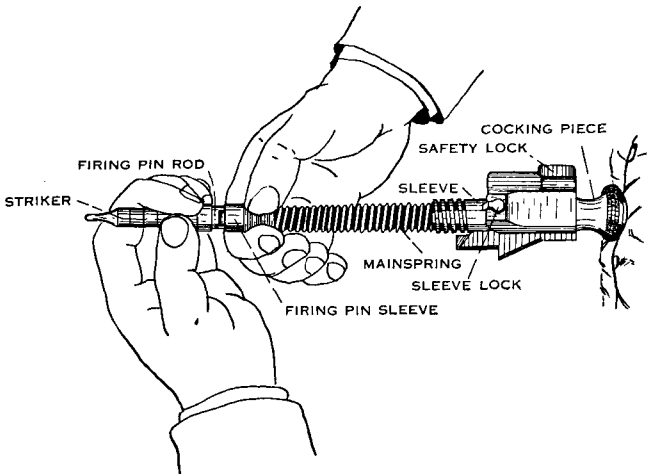

FIGURE 5.

With the safety lock turned down to the left, assemble the sleeve and firing pin; place the cocking piece against the breast and put on mainspring, firing pin sleeve, and striker.

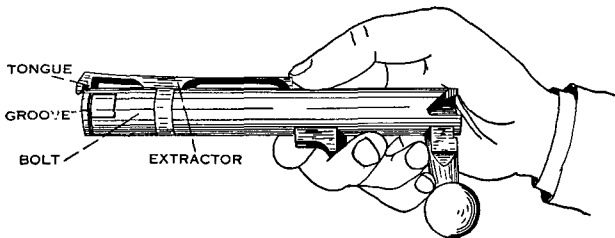

FIGURE 6.

(See fig. 5.) Hold the cocking piece between the thumb and forefinger of the left hand, and by pressing the striker against some object, not hard enough to injure it, force the cocking

piece back until the safety lock can be turned to the vertical position with the right hand; insert the firing pin in the bolt and screw up the sleeve until the sleeve lock enters its notch on the bolt. Pull the cocking piece back and turn the safety lock to the vertical position. Place the cut-off at the center notch; hold the piece under the floor plate in the fingers of the left hand, the thumb extending over the left side of the receiver; take the bolt in the right hand with the safety lock in a vertical position and safety lug up; press the rear end of the follower down with the left thumb and push the bolt into the receiver; lower the bolt handle; turn the safety lock and the cut-off down to the left.

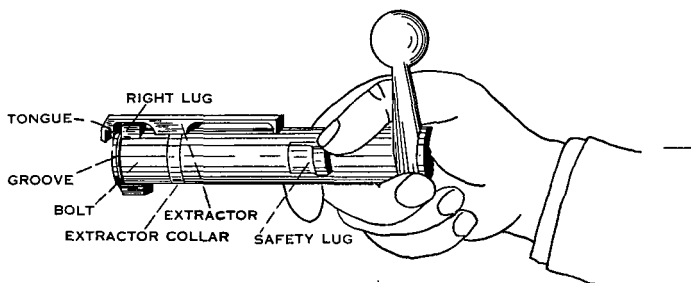

FIGURE 7.

■ 9. CARE AND CLEANING IN GARRISON.—*a.* Care and cleaning in garrison include the ordinary care of the rifle to preserve its condition and appearance in garrisons, posts, and camps during those periods when no firing is done.

*b.* Damp air and sweaty hands induce rust. The rifle should be cleaned and protected after every drill. Special precautions are necessary when the rifles have been used on rainy days and after tours of guard duty.

*c.* The barrack cleaning rod should be used. The use of the thong and brush will be confined to occasions when the barrack cleaning rod is not available. To avoid possible injury to the rifling at the muzzle, rifles will be cleaned from the breech, the bolt being removed for this purpose.

d. Care should be exercised that the chamber of the rifle is cleaned as thoroughly as is the bore. A roughened chamber may cause shells to stick.

e. To clean the rifle, rub it with a rag which has been slightly oiled, and then wipe it with a dry rag. Swab the bore with an oiled flannel patch and then with a dry one. Dust out all screw heads and crevices with a small, clean brush.

f. Immediately after cleaning, to protect the rifle, swab the bore thoroughly with a flannel patch saturated with medium rust-preventive compound; wipe over all metal parts, including the bolt mechanism and magazine, with an oiled rag; apply a few drops of light oil to all cams and working surfaces of the mechanism. Occasionally place a teaspoonful of linseed oil in the palm of the hand and polish the stock well.

g. After cleaning and protecting the rifle, place it in the gun rack without any covering whatever. The use of canvas or similar covers for the rifle is prohibited, as they collect moisture and rust the metal parts. When the barracks are being swept, gun racks will be covered to protect the rifles from dust.

■ 10. CARE AND CLEANING AFTER FIRING.—a. When a rifle has been fired, the bore and chamber must be cleaned thoroughly not later than the evening of the day on which it is fired. To clean the bore after firing, insert the muzzle in a vessel containing hot water and issue soap, hot water alone, or cold water; the cleaning rod with a cloth patch assembled is inserted in the breech and moved forward and back for about 1 minute, pumping the water in and out of the bore. While the bore is wet a brass or bronze wire brush, if available, should be run all the way through, then all the way back, three or four times. Water should again be pumped through the bore. Then wipe the cleaning rod dry, remove barrel from water, and using dry, clean flannel patches thoroughly swab the bore until it is perfectly dry and clean, being careful that the chamber is also dried and cleaned. Hold the breech of the barrel pointed toward the sky and examine the bore carefully for metal fouling. The bore must be similarly cleaned and regreased each day for the next succeeding 3 days to insure that no trace of fouling

remains. Oil will not free the bore of powder fouling—only water or solutions containing water will do this.

b. If no metal fouling is present, saturate a clean flannel patch with medium rust-preventive compound or the oil issued for this purpose, and swab the bore and chamber thoroughly, making certain that the bore and all metal parts of the rifle are covered with a thin coating of grease or oil.

c. Small flakes or lumps on the surface of the bore indicate the presence of metal fouling. Should such fouling occur, the rifle should be turned over to the Ordnance Department. New types of ammunition rarely produce metal fouling.

■ 11. CARE AND CLEANING IN THE FIELD.—The rifle is cared for in the field in a manner similar to that described in paragraphs 9 and 10. When the barrack cleaning rod is not available, the contents of the oiler and thong case, carried in the butt of the stock, may be used. In cleaning the bore by means of the thong the brush or rag should be drawn from the breech toward the muzzle. To prevent noise while carrying, the oiler should always be inserted into the stock so that the leather-tipped cap will be next to the butt plate cap.

■ 12. RULES WHEN ON THE RANGE.—a. Wipe out the bore and chamber with a clean cloth patch before the first firing each day.

b. Always clean at the end of each day's shooting.

c. Never leave a patch, oily rag, cork, or other obstruction in the bore.

d. It is essential for the proper working of all cams that they be kept lubricated.

### SECTION III

#### FUNCTIONING

■ 13. OPERATION.—a. *To load.*—To load the magazine, turn the cut-off up, showing "on"; draw the bolt fully to the rear and insert the cartridges from a clip, or singly from the hand. To load from a clip, place one end of a loaded clip into its

seat in the receiver, and with the fingers of the right hand under the rifle against the floor plate, and the base of the thumb on the powder space of the top cartridge near the clip, press the cartridges down with the thumb into the magazine with a firm, steady push until the top cartridge is caught by the right edge of the receiver. The empty clip is removed with the right hand. After loading the magazine, to place a round in the chamber, close the bolt. As the bolt is closed the top cartridge in the magazine is pushed forward into the chamber. When the rifle is used as a single loader, cartridges are inserted directly into the chamber with the hand, the cut-off being turned down.

*b. Extraction.*—Extraction of the empty case from the chamber by the extractor is started during the rotation of the bolt and is completed as the bolt is drawn to the rear.

*c. Ejection.*—When the bolt is drawn fully to the rear the head of the case strikes against the ejector point and the case is ejected from the receiver.

*d. Cut-off.*—When the cut-off is up and the bolt fully to the rear, the top cartridge in the magazine is forced up into the path of the bolt by the magazine spring. When the cut-off is turned down the magazine is "off." The bolt cannot be drawn fully back, and its front end, projecting over the rear end of the upper cartridge, holds the latter down in the magazine below the action of the bolt. The magazine mechanism then remains inoperative, and the rifle can be used as a single loader with the cartridges in the magazine held in reserve.

*e. Follower.*—In magazine fire, after the last cartridge has been fired and the bolt drawn fully to the rear, the follower rises and blocks the path of the bolt, thus showing that the magazine is empty. A new clip may then be inserted and the magazine refilled, or the bolt may be closed without reloading by first forcing the follower down until it is below the path of the bolt.

*f. To unload.*—With the cut-off up, move the bolt forward and back until no cartridges remain in the magazine or chamber.

*g. Safety device.*—To set at safe, which can only be done when the piece is cocked, turn the safety lock to the right.



This locks the firing pin in position and the piece cannot be fired. To set at ready, turn the safety lock to the left.

*h. Cocking.*—The piece may be cocked either by raising the bolt handle until it strikes the left side of the receiver and then turning it down, or by pulling the cocking piece directly to the rear.

#### SECTION IV

#### INDIVIDUAL SAFETY PRECAUTIONS

■ 14. RULES.—*a.* Consider every rifle to be loaded until you have examined it and proved it to be unloaded. Never trust your memory as to its condition in this respect.

*b.* Never point the rifle at anyone you do not intend to shoot, nor in a direction where an accidental discharge may do harm.

*c.* Always unload the rifle if it is to be left where someone else may handle it.

*d.* Always point the rifle up when snapping the trigger after examination.

*e.* If it is desired to carry the piece cocked with a cartridge in the chamber, the bolt mechanism should be secured by turning the safety lock to the right.

*f.* Under no circumstances should the firing pin be let down by hand on a cartridge in the chamber.

*g.* Never fire a rifle with any grease, cleaning patch, dust, dirt, mud, snow, or other obstruction in the bore. To do so may burst the barrel.

*h.* Never grease or oil the ammunition or the walls of the rifle chamber. This creates a hazardous pressure on the rifle bolt.

*i.* See that the ammunition is clean and dry. Examine all live *and dummy ammunition*. Turn in all cartridges with loose bullets or which appear to be otherwise defective.

*j.* Do not allow the ammunition to be exposed to the direct rays of the sun for any length of time. This creates hazardous chamber pressures.

## SECTION V

## INSTRUMENTS

■ 15. FIELD GLASS, TYPE EE.—The field glass, type EE (fig. 8), complete, consists of the field glass with its carrying case.

*a. Description.*—(1) The field glass consists of two compact prismatic telescopes (5) pivoted about a common hinge (4) which permits adjustment for interpupillary distances. A scale (3), graduated every 2 millimeters from 56 to 74, permits the observer rapidly to set the telescope to suit his eye distance when the spacing of his eyes is known. The eyepiece (1) can be focused independently for each eye by screwing in or out. Each is provided with a diopter scale (2) for rapid setting when the observer knows the correction for his eye. The zero graduations indicate the settings for normal eyes.

(2) The left telescope is fitted with a glass reticle (fig. 9) upon which are etched a vertical mil scale, a horizontal mil scale, and a stadia graduated similarly to the sight leaf graduation on the service rifle.

*b. Use.*—The field glass is used for observations and the measurement of small horizontal and vertical angles in mils. The vertical stadia scale (inverted sight leaf) is used to pick up auxiliary aiming marks in direct laying and to determine troop safety for overhead fire.

*c. Preliminary adjustments; interpupillary distances.*—To adjust the glass so that the eyepieces are the same distance apart as the pupils of the observer's eyes, point the glass at the sky and open or close the hinged joint until the field of view ceases to be two overlapping circles and appears to be one sharply defined circle. Note the reading on the scale (3), which indicates the spacing of the observer's eyes. The similar setting of any other field glass will then accommodate his eyes.

*d. Focus of the eyepiece.*—Look through the glasses, both eyes open, at an object several hundred yards away. Place the hand over the front of one telescope and screw the eyepiece of the other in or out until the object is sharply defined. Repeat this operation for the other eye and note the

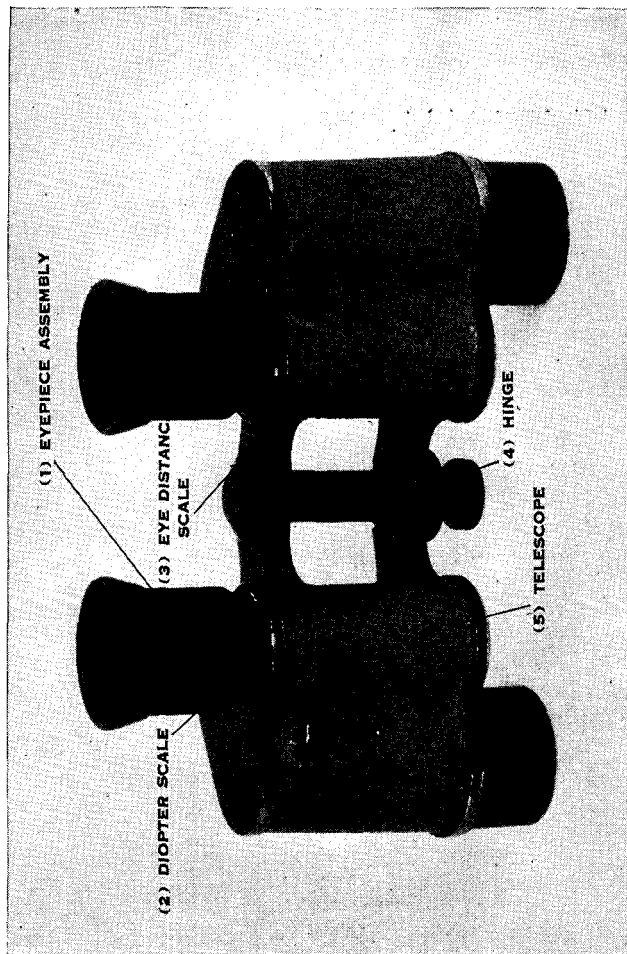

FIGURE 8.—Field glass, type EE.

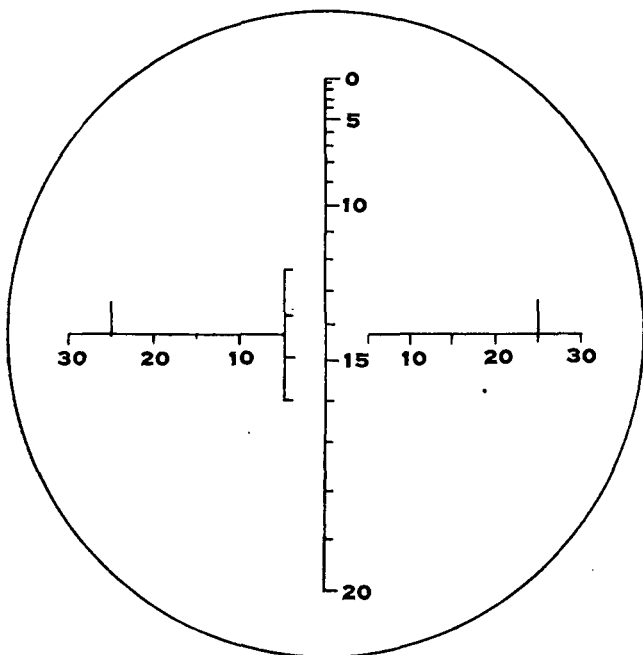

FIGURE 9.—Reticle graduations, field glass, type EE.

reading on the diopter scale. The similar setting of any other field glass will accommodate the eyes.

*e. Operation.*—(1) In using the glass it should be held in both hands and pressed lightly to the eyes so as to keep the relation with the eyes constant without transmitting tremors from the body. The bent thumbs should fit into the outer edges of the eye sockets in such a manner as to prevent light from entering in rear of the eyepieces. When possible it is best to use a rest for the glass or elbows.

(2) The mil scales are seen when looking through the glass, and by superimposing them upon the required objects the horizontal and vertical angles may be read between these objects.

*f. Care.*—The field glass is a rugged, serviceable instrument but should not be abused or roughly handled.

## CHAPTER 2

### MARKSMANSHIP—KNOWN-DISTANCE TARGETS

	Paragraphs
SECTION I. General .....	16-23
II. Preparatory marksmanship training.....	24-31
III. Qualification courses .....	32-36
IV. Range practice.....	37-39
V. Equipment; known-distance targets and ranges; range precautions.....	40-43
VI. Small-bore practice.....	44-47

#### SECTION I

#### GENERAL

■ 16. PURPOSE.—The purpose of this chapter is to provide a thorough and uniform method of training individuals to be good rifle shots and of testing their proficiency in firing at known-distance targets.

■ 17. NECESSITY FOR TRAINING.—*a.* Without proper training a man instinctively does the wrong thing in firing the rifle. He gives the trigger a sudden pressure which causes flinching. However, if he is thoroughly instructed and drilled in the mechanism of correct shooting, and is then carefully and properly coached when he begins firing, he rapidly acquires correct shooting habits. It is much easier to develop into an excellent shot a man who has never fired a rifle, than it is to correct the errors of a man who has done a good deal of shooting under improper supervision.

*b.* Rifle firing is a mechanical operation which anyone who is physically and mentally fit to be a soldier can learn to do well if properly instructed. The methods of instruction are the same as those used in teaching any mechanical operation. The training is divided into steps which must be taught in proper sequence. The soldier is carefully coached and is corrected whenever he starts to make a mistake.

■ 18. **FUNDAMENTALS.**—To become a good rifle shot the soldier must be thoroughly trained in the following essentials of good shooting:

- a. Correct sighting and aiming.
- b. Correct positions.
- c. Correct trigger squeeze.
- d. Correct application of rapid fire principles.
- e. Knowledge of proper sight adjustments.

■ 19. **PHASES OF TRAINING.**—*a.* Marksmanship training is divided into the following phases:

- (1) Preparatory marksmanship training.
- (2) Range practice.

b. No individual should be given range practice until he has had a thorough course in preparatory training.

c. The soldier should be proficient in mechanical training before he receives instruction in marksmanship training.

d. Every man who is to fire on the range will be put through the entire preparatory course. No distinction will be made between recruits and men who have had range practice, regardless of their previous qualification. Some part of the preparatory instruction may have escaped them in previous years; it is certain that some of it has been forgotten, and in any case it will be helpful to go over it again and refresh the mind on the subject.

e. When necessary and when time permits, all of the non-commissioned officers of the company should be put through a course of instruction and required to pass a rigid test before the period of preparatory training for the company begins.

■ 20. **PRACTICE SEASONS.**—*a. Regular.*—(1) Under ordinary conditions the regular practice season for the Regular Army will cover a period of not more than 3 weeks for each organization. A period of 1 week should be devoted to preparatory exercises and 2 weeks to range practice. When unforeseen circumstances are such as to cause a delay during the period of instruction, the time may be extended by the post commander.

(2) The regular practice season for units of the National Guard and other components of the Army will be of such duration and ordered at such times as may be best suited for effective training.

(3) It is advisable that battalions or smaller units be relieved from routine garrison duty during the period of preparatory training and range practice.

(4) In order that officers and enlisted men of the Regular Army, National Guard, and Organized Reserves may be familiar with their exact duties of marksmanship training during mobilization, organizations should not exceed the number of hours set forth in model schedules (par. 141). Under no conditions will any man be given range practice until he has had a thorough course in the preparatory exercises.

*b. Supplementary.*—Supplementary practice is not necessary when the regular practice season has been efficiently conducted, except in cases where a large number of unqualified men join the organization after the regular practice season. The supplementary practice season is usually placed as late in the fall as is consistent with efficient instruction. However, this practice may be held at any time when circumstances make it advisable.

■ 21. CONTINUOUS PRACTICE.—Rifle practice is not limited to a particular season. Subject to ammunition allowances, commanding officers will adopt such measures as may be necessary to maintain a high state of excellence in rifle firing throughout the year. The particular measures adopted will depend upon the facilities near the post or station. The measures taken may provide for competitions between individuals or organizations or the encouragement of small-bore rifle teams.

■ 22. RECRUIT INSTRUCTION.—As part of their recruit training, all recruits armed with the rifle will be thoroughly instructed in mechanical training and in the fundamental elements of rifle marksmanship—sighting and aiming, positions, trigger squeeze, and rapid fire. They will be given a final examination and should fire one of the small-bore qualification courses outlined in paragraph 47. Instruction in rifle marksmanship will commence with the initial instruction of the recruit and will continue throughout the period of recruit training.

■ 23. LEADERS AND COMMANDERS; DUTIES AND EQUIPMENT.—*a. Duties.*—(1) *Squad leader.*—(a) Organizes the work in his

squad so that each man is occupied during the preparatory period in the prescribed form of training for target practice.

(b) Examines each man in his squad at the end of the training on each preparatory step and assigns him a mark in the proper place on the blank form showing state of training.

(c) Sees that each man takes proper care of his rifle and that he cleans it at the end of each day's firing.

(d) Enforces correct aiming, position, and trigger squeeze when fire is simulated in drills and maneuvers.

(2) *Platoon leader.*—Supervises and directs the squad leader in training his squad; personally checks each man in his platoon on the points enumerated on the blank form; and examines each man along the lines outlined in paragraph 31.

(3) *Company commander.*—Requires the prescribed methods of instruction and coaching to be carried out carefully and in detail; supervises and directs the squad and platoon leaders; in companies of less than 60 men, performs the duties prescribed for platoon leaders in (2) above.

(4) *Battalion commander.*—Requires the officers and non-commissioned officers to be familiar with and understand the prescribed methods of instruction and coaching; supervises the instruction within his battalion and requires the companies to follow out the preparatory exercises and methods of coaching carefully and in detail.

*b. Equipment.*—All equipment used in the preparatory exercises must be accurate and be carefully made. One of the objects of these exercises is to cultivate a sense of exactness and carefulness in the minds of the men undergoing instruction. They cannot be exact with inexact instruments, and they will not be careful when working with equipment that is carelessly made (see pars. 40 and 154).

## SECTION II

### PREPARATORY MARKSMANSHIP TRAINING

■ 24. GENERAL.—*a.* The purpose of preparatory marksmanship training is to teach the soldier the essentials of good shooting, and to develop fixed and correct shooting habits before he undertakes range practice.



b. Preparatory marksmanship training is divided into six steps, as follows, and should be concentrated in the period of time allotted:

(1) Sighting and aiming exercises.

(2) Position exercises.

(3) Trigger-squeeze exercises.

(4) Rapid-fire exercises.

(5) Instruction in the effect of wind, sight changes, and use of the score book.

(6) Examination of men before starting range practice.

c. The first four steps listed above are given in the sequence listed; each succeeding step involves the use of technique learned in preceding steps. Instruction in the effect of wind, sight changes, and the use of the score book is not a training step that need be given in any particular sequence, but will be given before the examination which is the final step prior to range practice; these subjects can be taught indoors during inclement weather.

d. Each of the first four steps starts with a lecture by the instructor to the assembled group. This lecture includes a demonstration by a squad which the instructor puts through the exercises that are to constitute the day's work. He shows exactly how to do the exercises that are to be taken up and explains why they are done and their application to rifle shooting. He shows how the squad leader organizes the work so that no men are idle, and how they coach each other when they are not under instruction by an officer or noncommissioned officer. These talks and demonstrations are an essential part of the training. If properly given they awaken the interest and enthusiasm of the whole command for the work and give an exact knowledge of how each step is to be carried on—something that men cannot get from reading a description, no matter how accurate and detailed that description may be. The instructor who gives these talks and demonstrations may be the platoon leader of his platoon, the company commander of his company, or the battalion commander of his battalion; or he may be a specially qualified officer who has been detailed as officer in charge of rifle instruction. (See note.) The instructors who apply the demonstrated exercises to the men of the



permit. The company commander will carefully supervise the work. He should pick out men at random through the different platoons from time to time and put them through a test to see if the instruction is thorough and is progressing satisfactorily.

*g.* Interest and enthusiasm must be sustained and everything possible should be done to stimulate them. As soon as these exercises deteriorate into a perfunctory performance of physical exercise they do more harm than good.

*h.* Careful attention will be paid to the essential points as shown in the form of questions and answers in paragraph 31. This will be consulted by the instructor during each step of the preparatory work. Each man should be tested thoroughly before he is allowed to fire.

*i.* During the preparatory exercises, whenever a man is in a firing position, the coach-and-pupil system is used. The men are grouped in pairs and take turns in coaching each other. The man undergoing instruction is called the pupil. The man giving instruction is called the coach. When the men of a pair change places the pupil becomes the coach and the coach becomes the pupil.

*j.* Correct shooting habits should be acquired during the preparatory training period. All errors must be noted, brought to the attention of the pupil, and corrective action taken. Each individual must be impressed with the importance of exactness in every detail. For example, there is no such thing as an aim that is *about right*; it is either perfect or it is incorrect.

*k.* Practice dummy ammunition only will be used during the preparatory training. The use of range dummy ammunition except on the firing line is prohibited.

■ 25. BLACKENING THE SIGHTS.—In all preparatory exercises involving aiming, and in all range firing, both sights of the rifle should be blackened. Before blackening, the sights should be cleaned and all traces of oil removed. The blackening is done by holding each sight for a few seconds in the point of a small flame which is of such a nature that a uniform coating of lampblack will be deposited on the metal. Materials commonly used for this purpose are carbide lamp,

cylinder of carbide gas, kerosene lamp, candles, small pine sticks, and shoe paste. Carbide gas from a cylinder or a lamp is the most satisfactory of the materials named.

■ 26. FIRST STEP—SIGHTING AND AIMING (fig. 10).—*a. First exercise.*—The instructor displays a sighting bar before his group and explains its use as follows:

(1) The front and rear sights on the sighting bar represent enlarged rifle sights.

(2) The sighting bar is used in the first sighting and aiming exercise because with it small errors can be seen easily and explained to the pupil.

(3) The eyepiece requires the pupil to place his eye in such position that he sees the sights in exactly the same alinement as seen by the coach.

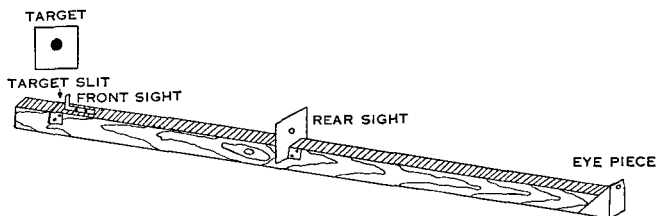

FIGURE 10.—Sighting bar.

(4) There is no eyepiece on the rifle, but the pupil learns by use of the sighting bar how to aline the sights properly when using the rifle.

(5) The removable target attached to the end of the sighting bar is a simple method of readily alining the sights on a bull's-eye.

(6) The instructor explains the open and the peep sight to the assembled group, showing each man the illustrations of a correct sight alinement (fig. 11 ① ② ④ and ⑤).

(7) First with the peep sight and then with the open sight the instructor adjusts the sights of the sighting bar, with target removed, to illustrate a correct alinement of the sights. Each man of the assembled group looks through the eyepiece at each of the sight adjustments.

(8) He adjusts the sights of the sighting bar with various small errors in sight alinement and has each man of the assembled group endeavor to detect the error.

(9) The instructor describes a correct aim, showing the illustration to each man. He explains that the top of the front sight is seen through the middle of the circle and just touches the bottom of the bull's-eye, so that all of the bull's-eye can be clearly seen (fig. 11 ③ and ⑥).

(10) The eye should be focused on the bull's-eye in aiming, and the instructor assures himself by questioning the men that each understands what is meant by focusing the eye on the bull's-eye.

(11) The instructor adjusts the sights of the sighting bar and the removable target so as to illustrate a correct aim and requires each man of the group to look through the eyepiece to observe this correct aim.

(12) He adjusts the sights and the removable target of the sighting bar so as to illustrate various small errors, and requires each man in the group to attempt to detect the error.

(13) The exercise described above having been completed by the squad leader or other instructor, the men are placed in pairs and repeat the exercise by the coach-and-pupil method.

(14) As soon as a pupil is considered proficient in the first sighting and aiming exercise, he is put through the second and third sighting and aiming exercises by the instructor. Such pupils are then placed in pairs to instruct each other in these two exercises by the coach-and-pupil method.

*b. Second exercise.*—(1) A rifle with sights blackened is placed in a rifle rest and pointed at a blank sheet of paper mounted on a box (fig. 12). Without touching rifle or rifle rest, the coach takes the position illustrated and looks through the sights. The coach directs the marker by command or improvised signal to move the small disk until the bottom of the bull's-eye is in correct alinement with the sights (fig. 11 ③ and ⑥) and then commands; HOLD, to the marker. The coach moves away from the rifle and directs the pupil to look through the sights in order to observe the correct aim.

*FRONT SIGHT*

*PEEP SIGHT*

*OPEN SIGHT*

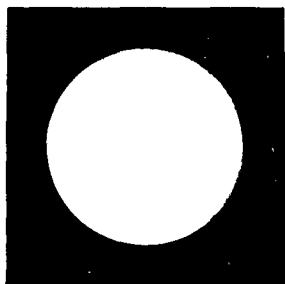

①



④

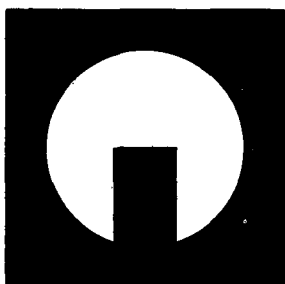

②



⑤

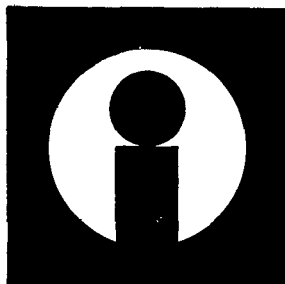

③



⑥

FIGURE 11.—Sight alignment.

(2) The marker moves the disk out of alinement. The pupil takes position and directs the marker to move the disk until the bottom of the bull's-eye is in correct alinement with the sights. The coach then looks through the sights to see if the alinement is correct.

(3) The coach alines the sights on the bull's-eye with various slight errors to determine whether or not the pupil can detect them.

*c. Third exercise.*—(1) The object of this exercise is to show the importance of uniform and correct aiming, and to instill into the mind a sense of exactness. At 50 feet and with a small bull's-eye a man should be able to place all



FIGURE 12.—Position for second sighting and aiming exercise.

three marks so that they could be covered by the unsharpened end of a lead pencil. (Fig. 12.)

(2) This exercise is conducted as follows: The rifle with the sights blackened is placed in a rifle rest and pointed at a blank sheet of paper mounted on a box. The pupil takes the position illustrated and looks through the sights without touching the rifle or rifle rest. The pupil directs the marker, by command or improvised signal, to move the disk until the bottom of the bull's-eye is in correct alinement with the sights, and then commands: **HOLD**, to the marker. The coach then looks through the sights to see if the alinement is correct. Then without saying anything to the pupil, he

commands: **MARK**, to the marker. The marker without moving the disk makes a dot on the paper with a sharp-pointed pencil inserted through the hole in the center of the bull's-eye. The marker then moves the disk to change the alinement. The pupil and coach, without touching the rifle or rifle rest, repeat this operation until three dots, numbered 1, 2, 3, respectively, have been made. These dots then outline the shot group and the pupil's name is written under it. The size and shape of the shot group will be discussed and the errors pointed out. This exercise will be repeated until proficiency is attained. (Fig. 12.)



FIGURE 13.—Position for third sighting and aiming exercise on long ranges.

(3) This exercise should also be held, during the period of the preparatory training, at 200 yards on a 10-inch movable bull's-eye (fig. 13), and if time permits at 500 yards on a 20-inch movable bull's-eye. These long-range shot group exercises teach the men to aim accurately at a distant bull's-eye the outlines of which are indistinct. If the exercise is properly handled, it helps greatly to sustain interest in the work. At 200 yards a man should be able to make a shot group that can be covered with a silver dollar, and at 500 yards a shot group which is not over 2 inches in diameter.

(4) Tissue paper may be used to copy off each pupil's shot group at long range. The name of the pupil is written



on the tissue paper under the shot group he made. These tracings are sent back to the firing line so that the pupil can see what he has done.

(5) The third sighting and aiming exercise, especially the 200-yard shot group work, will be carried on during the time devoted to the second and third preparatory steps. The purpose of continuing these exercises is to bring backward men up to the proper state of proficiency and to assist in keeping the men interested.

(6) Competition between the individuals of a squad to see which can make the smallest shot group is of value in creating interest in this exercise.

■ 27. SECOND STEP—POSITIONS.—*a. General.*—Instruction in positions includes the use of the gun sling, taking up the slack in the trigger, holding the breath while aiming, aiming, and the use of the aiming device.

*b. Gun sling.*—(1) The gun sling, properly adjusted, is of great assistance in shooting in that it helps to steady the rifle. Each man will be assisted by the instructor in securing the correct adjustment for his sling. In a firing position the sling should be adjusted to give firm support without discomfort to the soldier. The gun sling is readjusted for drill purposes by means of the lower loop without changing the adjustment of the upper loop.

(2) There are two authorized adjustments—the *loop* sling and the *hasty* sling. The hasty sling is more rapidly adjusted than the loop sling, but it gives less support in positions other than the standing position.

(a) *Loop adjustment* (fig. 14).

1. Loosen the lower loop.
2. Insert the left arm through upper loop from right to left, so that the upper loop is near the shoulder and well above the biceps muscle.
3. Pull the keepers and hook close against the arm to keep the upper loop in place.
4. Move the left hand over the top of the sling and grasp the rifle near the lower band swivel so as to cause the sling to lie smoothly along the hand and wrist. The lower loop, not used in this adjustment, should be so loose as to prevent any

pull upon it. Neither end will be removed from either swivel.

(b) *Hasty sling adjustment* (fig. 15).

1. Loosen the lower loop.
2. Grasp the rifle just in rear of the lower band swivel with the left hand and grasp the small of the stock with the right hand.

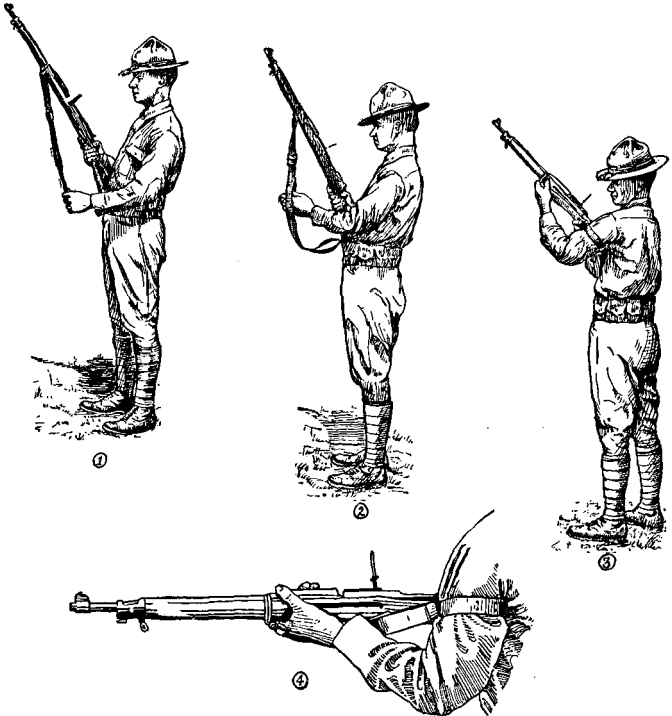

FIGURE 14.—Loop sling adjustment.

3. Throw the sling to the left and catch it above the elbow and high on the arm.
4. Remove the left hand from the rifle, pass the left hand under the sling, then over the sling, and

regrasp the rifle with the left hand so as to cause the sling to lie along the hand and wrist. The sling may be given one-half turn to the left and then adjusted. This twisting causes the sling to lie smoothly along the hand and wrist.

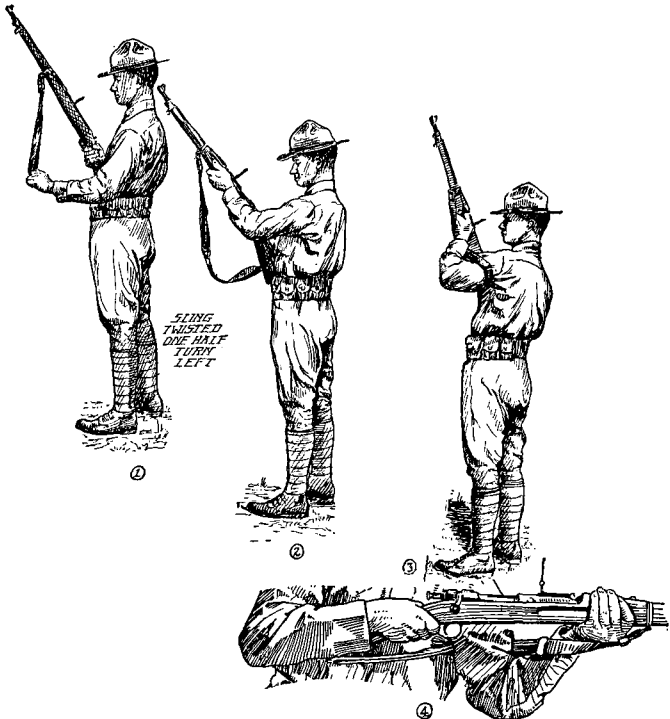

FIGURE 15.—Hasty sling adjustment.

*c. Taking up the slack.*—The first movement of the trigger which takes place when light pressure is applied is called *taking up the slack*. It is part of the position exercise because this play must be taken up by the finger as soon as the correct position is assumed and before careful aiming is begun. The

entire amount of slack in the trigger is taken up by one positive movement of the finger.

*d. Holding the breath.*—(1) Holding the breath in the proper manner while aiming is very important. It will be found that a large proportion of men in any group undergoing instruction in rifle practice do not know how to hold the breath in the proper manner. Each man must be carefully instructed and tested on this point. The correct manner of holding the breath must be practiced at all times during position and trigger-squeeze exercises and whenever firing or simulating fire.

(2) To hold the breath properly draw into the lungs a little more air than is used in an ordinary breath. Let out a little of this air and stop the remainder by closing the throat so that the air remaining in the lungs will press against the closed throat. Do not hold the breath with the throat open or by the muscular action of the diaphragm as if attempting to draw in more air. The important point is to be comfortable and steady while aiming and squeezing the trigger.

*e. Aiming.*—The rifle is carefully aimed at a target each time a firing position is assumed. The aiming device may be used by the coach to check the aim.

*f. General rules for positions.*—The general rules which follow are common to the prone, sitting, kneeling, and standing positions. The exact details of a position for any particular individual will depend on the conformation of the man.

(1) To assume any position, half face to the right and then assume the position.

(2) Upon assuming any position there is some point to which the rifle points naturally and without effort. If this point is not the center of the target, the whole body must be shifted so as to bring the rifle into proper alinement. Otherwise the firer will be firing under a strain because he will be pulling the rifle toward the target by muscular effort for each shot.

(3) The right hand grasps the small of the stock. The right thumb may be either around the small of the stock or along the right side of the stock.

(4) The left hand is against or near the lower band swivel, wrist straight, rifle placed in the crotch formed by the thumb and index finger and resting on the heel of the hand.

(5) The left elbow will be as nearly under the rifle as it can be placed without appreciable effort.

(6) Ordinarily the second joint of the index finger contacts the trigger. The first joint may be used by men the length of whose arm or the size of whose hand is such as to make it difficult to reach the trigger with the second joint, or to whom the first joint of the finger seems more natural and comfortable.

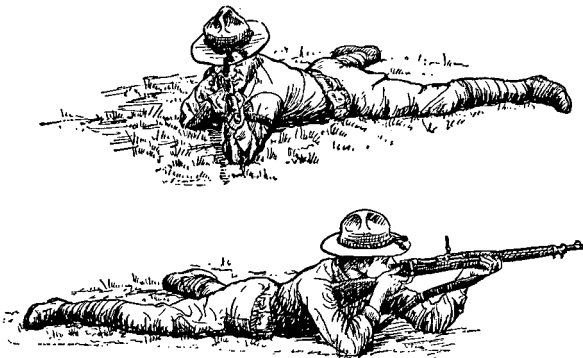

FIGURE 16.—Prone position.

(7) The cheek is pressed firmly against the stock and placed as far forward as possible without strain to bring the eye near the rear sight.

(8) The butt of the rifle is held firmly against the shoulder.

(9) The rifle should not be canted.

(10) Left-handed men who have difficulty with the right-hand position will be allowed to use the left-hand position.

*g. Prone position* (fig. 16).—(1) Body lying at an angle of about  $45^\circ$  to the line of aim with the spine straight; legs well apart; inside of the feet flat on the ground, or as nearly so as is possible without strain; elbows well under the body so as to raise the chest off the ground; right hand grasping the small of the stock; left hand near the lower band swivel, wrist

straight, rifle placed in the crotch formed by the thumb and index finger and resting on the heel of the hand; cheek pressed firmly against the stock with the eye as near the cocking piece as it can be placed without straining; gun sling properly adjusted and tight enough to give firm support, butt of the rifle pressed firmly against the shoulder.

(2) The elbows should not be unduly spread apart because such separation results in an unsteady position and brings the chest so near the ground that the neck has to be strained backward in order to see through the sights. This strained position of the neck interferes with good vision and tends to make the firer unsteady. The exact angle of the arms to the ground will depend upon the conformation of the man. The right elbow should be so placed that the right upper arm will not form an angle of less than  $45^{\circ}$  with the ground.

(3) The exact position of the left hand will depend on the length of arm and width of chest of the individual. It should be as near the lower band swivel as the conformation of the man will permit.

*h. Sandbag rest position* (fig. 17).—(1) The sandbag rest position conforms in every detail to the normal prone position described above, with the addition of a sandbag which supports the left forearm, wrist, and hand.

(2) The bag is a little more than half full and tied near the top so as to leave considerable free space above the sand.

(3) It is important that the sandbag be high enough to permit the taking of the normal prone position. The natural tendency is to have a low rest and to be very flat on the ground with the elbows spread apart. This is a faulty position which causes lower scores than if no rest at all were used. The sandbag when properly adjusted is a great help. When it is not properly adjusted it is a handicap.

(4) The sandbag rest position is used in the first stages of a pupil's training, not to teach steadiness of holding but to teach the correct trigger squeeze. By using the sandbag the slight unsteadiness of the hold is avoided, and the temptation to try to snap in the shot at the instant the sights touch the bull's-eye is eliminated.

(5) The coach will adjust the sandbag as follows:

(a) Have the pupil assume the prone position and aim at the target.

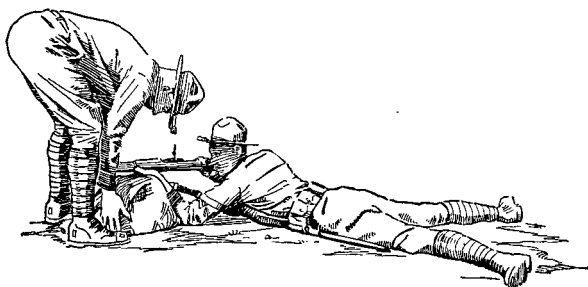
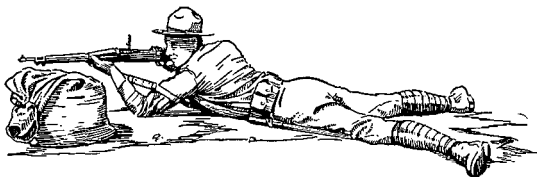

FIGURE 17.—Prone position with sandbag rest.

(b) Set the sandbag on its bottom and arrange the sand so that it is slightly higher than the back of the pupil's left hand.

(c) Facing the pupil, straddle the rifle barrel, and slide the sandbag against the pupil's left forearm, so that the narrow

side of the bag supports his forearm and wrist and the back of his hand rests on top.

(d) Lower the sandbag to the proper height by pounding it with the hand.

i. *Sitting position* (fig. 18).—(1) The firer sits half-faced to the right; feet well apart and well braced on the heels, which are dug slightly into the ground; body leaning well



FIGURE 18.—Sitting position.

forward from the hips with back straight; both arms resting inside the legs and well supported; cheek pressed firmly against the stock and placed as far forward as possible without straining; left hand near the lower band swivel, wrist straight, rifle placed in the crotch formed by the thumb and index finger and resting on the heel of the hand.



(2) The sitting position is used in the field when firing from ground that slopes downward to the front. In practicing this position the feet may be slightly lower than the ground upon which the pupil sits. Sitting on a low sandbag is authorized.



FIGURE 19.—Kneeling position.

(3) In the event the conformation of a man is such that he cannot assume the prescribed normal position, such changes as may be necessary to secure a steady, comfortable position are authorized.

*j. Kneeling position* (fig. 19).—The firer kneels half-faced to the right on the right knee, sitting on the right heel; the left knee bent so that the left lower leg is vertical (as seen from the front); left arm well under the rifle and resting on the left knee with the point of the elbow beyond the kneecap; right elbow above or at the height of the shoulder; cheek pressed firmly against the stock and placed



FIGURE 20.—Standing position.

as far forward as possible without strain. Sitting on the side of the foot instead of the heel is authorized.

*k. Standing position* (fig. 20).—The firer stands half-faced to the right; feet from 1 foot to 2 feet apart; body erect and well balanced; left elbow well under the rifle; left hand in front of the balance, wrist straight, rifle placed in the crotch formed by the thumb and index finger and resting on the heel of the hand; butt of the piece high up on the shoulder and firmly held; right elbow approximately

at the height of the shoulder; cheek pressed against the stock and placed as far forward as possible without strain. A position with the left hand against or under the trigger guard and with the left upper arm supported against the body is not a practical field position and is prohibited.

*1. Procedure in conducting position exercises.*—(1) Small bull's-eyes are used as aiming points. These bull's-eyes should be placed at a range of 1,000 inches and at different heights so that in aiming from various positions the rifle will be nearly horizontal, or standard known-distance targets may be installed at distances used on the known-distance range.

(2) Before taking up each phase of the position exercise the instructor assembles his squad or group, and—

(a) Shows them the proper method of blackening the front and rear sights of the rifle, and has each pupil blacken his sights.

(b) Explains and demonstrates the hasty sling adjustment and assists each pupil to adjust his sling. He explains the loop sling adjustment and assists each pupil to adjust his sling.

(c) Explains and demonstrates the proper manner of taking up the slack and has each pupil practice it.

(d) Explains and demonstrates the proper manner of holding the breath and has each pupil practice it.

(e) Explains and demonstrates the use of the aiming device.

(f) Explains the general rules which apply to all positions.

(g) Explains and demonstrates the different positions.

(3) Following explanations and demonstrations the instruction becomes individual by the coach-and-pupil method. Each pupil, after seeing that his sights are blackened, adjusts his sling, takes position, takes up the slack, aims carefully, and holds his breath while aiming. As soon as his aim becomes unsteady the exercise ceases. After a short rest the pupil repeats the exercise without further command. The trigger is not squeezed in the position exercises. Exercises are conducted in all positions.

(4) *Duties of the coach.*—In the position exercises the coach sees that—

(a) The sights are blackened.

(b) The gun sling is properly adjusted, is tight enough to give support, and is high up on the arm.

(c) The proper position is taken.

(d) The slack is taken up promptly.

(e) The pupil aims.

(f) The breath is held while aiming.

The coach checks the pupil's manner of holding his breath by watching his back. The pupil's aim may be checked occasionally by means of the aiming device.

■ 28. THIRD STEP—TRIGGER SQUEEZE.—*a. Importance of trigger squeeze.*—(1) The most important item in rifle shooting is to squeeze the trigger in such a way as to fire the rifle without affecting the aim. Misses and poor shots are due to spoiling the aim just before the discharge takes place. This is done by jerking the trigger and flinching. The trigger must be squeezed so steadily that the firer cannot know the instant the piece will be fired. If a man squeezes the trigger so steadily that he cannot know when the discharge will take place, he does not spoil his aim and he will not flinch, because he does not know when to flinch.

(2) No good shot attempts to discharge the piece instantly upon alining his sights on the mark. He holds his aim as accurately alined on the mark as possible and maintains a steadily increasing pressure upon the trigger until the shot is fired. This method of squeezing the trigger must be carried out in all simulated firing or the value of the practice is lost.

(3) There is only one correct method of squeezing the trigger—a steady increase of pressure so that the firer does not know when the discharge will take place.

(4) Expert shots are men who through training have learned to increase the pressure only when the sights are in correct alinement with the bull's-eye. When the sights become slightly out of alinement, they hold what they have with the finger and only continue the increase of pressure when the sights again become properly alined.

(5) The difference between poor shots and good shots is measured in their ability to squeeze the trigger properly. Any man with fair eyesight and strength can aline the sights on the target and hold them there for an appreciable length

of time. When he has acquired sufficient will power and self-control to forget that there is to be an explosion and a shock, and squeezes the trigger with a steady increase of pressure until the rifle is fired, he has become a good shot, and not until then. This squeeze of the trigger applies to rapid fire as well as slow fire. The increase of pressure is faster in rapid fire but the process is the same.

*b. Calling the shot.*—The pupil must always notice where the sights are pointed at the instant the rifle is fired, and call out at once where he thinks the bullet will hit. Shots are called even when simulating fire at a mark, so as to acquire the habit and to develop a closer hold. No man can become a good shot until he is able to call his shot before it is marked. Inability to call a shot indicates the firer did not know where the sights were pointing at the time the rifle was fired; in other words, he shut his eyes first and fired afterward.

*c. Trigger-squeeze exercise.*—(1) *General.*—(a) The instructor explains to the assembled squad or group the importance of correct trigger squeeze. He assures himself by questions that each pupil understands what is meant by a *steady increase of pressure*; that is, that the increase is only applied when the aim is correct and then by a steady increase and not by a sudden pressure. The instructor explains the necessity for calling the shot. The above points having been explained, the instruction becomes individual by the coach-and-pupil method supervised by the instructor.

(b) The pupil is first taught the trigger squeeze in the prone position with the sandbag rest. In this position he can hold steadily and has not the temptation to *snap* the shot the instant the front sight touches the bull's-eye, as he has in a less steady position. After he has learned the principles of correct trigger squeeze with the sandbag rest, he is instructed in the other positions, but for the first half day at least he is not allowed to squeeze the trigger except in the prone position, first with, and then without, the sandbag rest.

(c) A great deal of trigger-squeeze exercise is necessary, but it must be carefully watched and coached. Trigger squeeze exercise that is not along the right lines is worse than none.

(d) Soldiers should not be allowed to simulate fire until they have been thoroughly instructed in trigger squeeze, and then in all drills and field exercises where fire is simulated they should be cautioned to aim at definite objects and to carry out the correct principles of aiming, squeezing the trigger, and calling the shot.

(2) *Procedure.*—The instruction is individual by the coach-and-pupil method. Aiming targets similar to those mentioned for the position exercises are used. The exercise is conducted at will in a manner as outlined for the position exercises.

(3) *Duties of the coach.*—In the trigger-squeeze exercises the coach insures that—

(a) The sights are blackened.

(b) The gun sling is properly adjusted, is tight enough to give support, and is high up on the arm.

(c) The proper position is taken.

(d) The slack is taken up promptly.

(e) The pupil aims, checking occasionally by means of the aiming device.

(f) The breath is held while aiming. He checks the breathing by watching the back of the pupil.

(g) The trigger is squeezed properly.

(h) The pupil calls the shot.

■ 29. **FOURTH STEP—RAPID FIRE.**—*a. General principles.*—(1) All the points learned in slow fire are applied in rapid fire. It is especially important that the men understand that the aim and the trigger squeeze are the same as in slow fire. Time is gained by taking position rapidly, by working the bolt rapidly, by reloading the magazine quickly and without fumbling, and by keeping the eye on the target while working the bolt.

(2) The importance of correct rapid-fire training cannot be too strongly emphasized. This is a phase of instruction that is often neglected. In rapid fire, accuracy is not sacrificed for rapidity. Through training, accurate fire becomes more and more rapid until the ability to fire from 10 to 15 accurate shots per minute is acquired, but no man will be permitted to attempt to fire more than 10 shots per minute until he has had long training on the rifle range and has be-

come a seasoned shot. Recruits having target practice for the first time should not be admonished for failing to fire the prescribed number of rounds in the stated time limit. It is advisable to extend the time 10 or 15 seconds when they first begin rapid-fire practice on the range.

(3) Careful coaching is essential to prevent acquiring the habit of looking into the chamber while working the bolt. The man who looks into the chamber works the bolt slowly. He loses time in finding his own target again and often fires on the wrong target. The application in war is apparent; a soldier who takes his eye off an indistinct target to look into the chamber while working the bolt may be unable to locate his target again.

*b. Bolt-operation exercise.*—(1) *General.*—(a) This exercise is held for the purpose of acquiring a smooth and rapid bolt operation. The trigger is tied back to the trigger guard in order to cause the bolt action to be the same as it is when the trigger is pressed. If the trigger is not thus tied, the piece will remain cocked when the bolt is closed, and the amount of force necessary to raise the bolt again will be less than when actually firing or simulating firing. Cam surfaces on the bolt should be lubricated to avoid undue wear during these exercises.

(b) Practice in bolt-operation exercise should be held in all positions, and no pupil will be considered proficient until he can operate the bolt at least 20 times in 20 seconds while in the prone position. The first hour of rapid-fire training should be devoted to bolt-operation exercises. Thereafter each pupil should be given additional practice from time to time until he is considered proficient.

(2) *Procedure.*—The exercise is conducted by the coach-and-pupil method. The instructor explains and demonstrates that the bolt is jerked fully back and forced home with practically one motion, instead of by four distinct motions as men are inclined to do at first; that the elbows and the butt of the rifle remain in place; that the muzzle is allowed to drop down and to the right as the bolt is opened, and returned to the horizontal as the bolt is closed. Emphasis is placed upon the detailed duties of the coach as listed in (3) below. Exercises should not be continued longer than about 20 sec-

onds at a time. Frequent changes of coach and pupil are necessary to prevent undue fatigue. After requiring the pupils to assume a firing position, the instructor commands: 1. BOLT-OPERATION EXERCISE, READY, 2. EXERCISE, 3. CEASE FIRING, 4. REST.

(3) *Duties of the coach.*—In the bolt-operation exercise the coach insures that—

(a) The bolt is operated properly and rapidly.

(b) The eye is kept on the target.

(c) The right hand is brought to the small of the stock, the rifle to a horizontal position, and the cheek placed against the stock each time the bolt is closed.

(d) The butt of the rifle is kept against the shoulder.

(e) The elbows are kept on the ground if in the prone position, or between the legs if in the sitting position.

(f) No attempt is made to aim or press the trigger.

*c. Taking positions rapidly.*—(1) *Prone position.*—(a) (Fig. 21 ①.)—The movement is described by the numbers for the purpose of instruction in the sequence of the movement. After this sequence is learned the position will be taken as one motion.

1. Being at the READY, sling adjusted, points selected at which right and left elbows are to rest when in the prone position, and the point on the ground just below the butt of the rifle when in the firing position marked, the rifle grasped with the left hand just below the lower band and the right hand at the heel of the stock, bend both knees to the ground.
2. Place the butt of the rifle on the ground at the point marked.
3. Place the left elbow on the ground.
4. Place the butt of the rifle against the right shoulder with the right hand, at the same time spreading the feet apart.
5. Grasp the small of the stock with the right hand and place the right elbow on the ground.

(b) (Fig. 21②.)—The movement is described by the numbers for the purpose of instruction in the sequence of movement. After this sequence is learned the position will be



taken as one motion. These movements will bring the firer into his normal position with the rifle pointing at the target. Care should be taken to place the butt of the rifle on the ground without jar and to place the elbows on the ground in the same manner. With practice this position can be as-

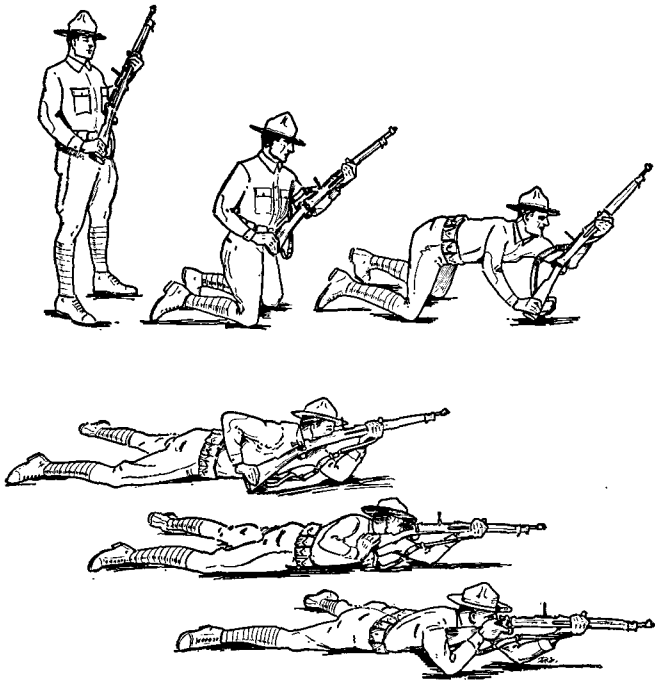

①

FIGURE 21.—Methods of assuming the prone position.

sumed very rapidly and without shock. When properly done the feet will still be sliding into position when the rifle is being placed on the shoulder, and the left elbow will come to the ground at almost the same time that the backward movement of the body is completed.

1. Being at the READY, sling adjusted, points selected at which right and left elbows are to rest when in the prone position, throw the right foot well back and bend the left knee as low as possible, placing

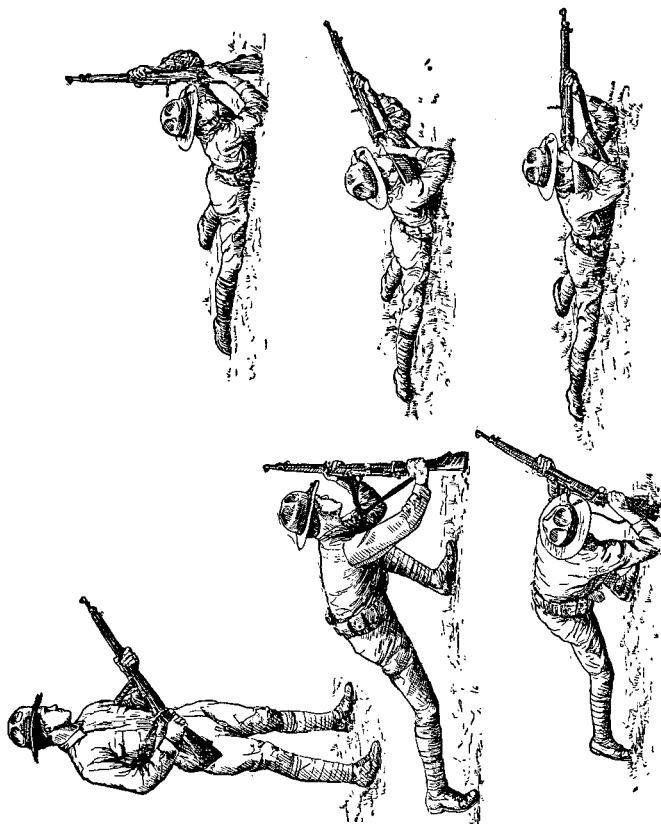

FIGURE 21.—Methods of assuming the prone position—Continued.

the butt of the rifle on the ground 4 or 5 inches to the left, and slightly in front of the spot where the right elbow is to rest. The grip of the rifle is retained with both hands.

2. Place the right elbow on the ground.
3. Place the left leg back near the right one, feet apart, and slide well back while lying on the belly.
4. Take the butt of the rifle off the ground and place it against the right shoulder.
5. Lower the left elbow to the ground.

(2) *Rushing*.—(a) Being in the prone position with the rifle loaded and locked and with the sight leaf laid down, loop sling adjusted on the left arm, the command is: 1. PREPARE TO RUSH, 2. UP. At the command PREPARE TO RUSH—

1. Draw the arms in until the hands are opposite the chin, elbows down and away from the body. At the command UP—
2. Raise the body by straightening the arms.
3. Shift the weight of the body to the right leg and arm and bring the left leg forward with the knee fully bent.
4. Spring forward and run to the firing point. Grasp the rifle with both hands, left hand just below the lower band and the right hand at the small of the stock.

(b) Upon arrival at the firing point—

1. Advance the left foot, turning it across the front of the body.
2. Drop forward on the outside of the left knee and at the same time extend the rifle, grasped in both hands and held vertically, so that the butt strikes the ground at full arm's length directly in front of the left knee.
3. Pivoting on the left knee and the butt of the rifle, roll forward on to the left elbow and left side.
4. With the right hand raise the sight leaf, unlock the piece, and place the butt of the rifle on the right shoulder.
5. Grasp the small of the stock with the right hand and place the right elbow on the ground.

(c) If the hasty sling is used (fig. 22) it will be necessary to modify the steps in taking the prone position described in (b) 3 and 4 above, respectively, as follows:

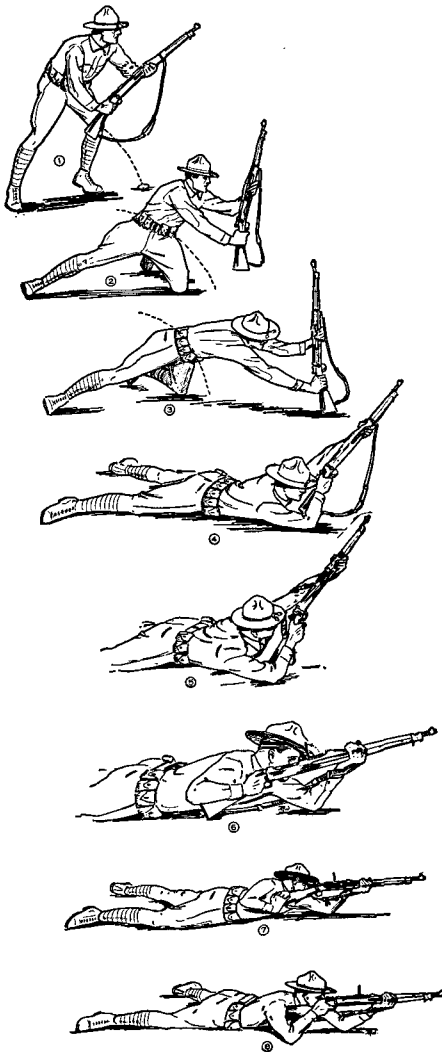

FIGURE 22.—Assuming the prone position after rushing, using the hasty sling.

1. Pivoting on the left knee and the butt of the rifle, roll forward on the right elbow and right side.
2. Throw the sling to the left and catch it above the elbow and high on the arm. Remove the left hand from the rifle, pass the left hand under the sling and then over the sling, and regrasp the rifle just below the lower band with the left hand. Place the left elbow on the ground.

(3) *Sitting position.*—(a) To assume the sitting position rapidly, break the fall by placing the right hand on the ground slightly to the right rear of the spot on which to sit.

(b) In practicing for range firing, first sit down and aim at the target in the normal sitting position. Then mark the position of the heels and the spot on which to sit. Then at the command **READY ON THE FIRING LINE**, stand with the heels in the places made for them. As the target appears, sit down on the spot marked, breaking the fall with the right hand, place the butt of the rifle on the shoulder with the right hand, grasp the small of the stock with the right hand, and assume the aiming position.

(4) *Kneeling position.*—To assume the kneeling position rapidly—

(a) *From standing.*—First kneel and aim at the target in the normal kneeling position. Then mark the position of the feet and the right knee. At the command **READY ON THE FIRING LINE**, stand with the feet in the places marked for them. As the target appears, kneel with the right knee on the spot marked, place the butt of the rifle on the shoulder with the right hand, grasp the small of the stock with the right hand and assume the aiming position.

(b) *After a rush.*—Upon arrival at the firing point, kneel on the right knee, with the right hand raise the sight leaf, unlock the piece, and place the butt of the rifle against the right shoulder. Grasp the small of the stock with the right hand and assume the aiming position.

(5) *Practice required.*—Taking positions rapidly from the standing position and after a run should be practiced at will, using the coach-and-pupil system.

*d. Rapid-fire exercise.*—(1) *General.*—The instructor assembles his squad or group and explains and demonstrates—

(a) The correct method of loading a clip of ammunition into the magazine, using dummy cartridges for the demonstration (par. 13a).

(b) The working of the bolt while in the prone and sitting positions.

(c) The disadvantage of looking into the chamber while working the bolt and of looking into the magazine to see if there are any more cartridges left.

(d) That the follower holds the bolt back when the magazine is empty.

(e) That the butt of the rifle is never taken from the shoulder when working the bolt.

(f) That a quick, confident movement of the hand in taking the clip from the belt and placing it in the clip slot is more rapid than a hurried movement.

(2) *Procedure*.—In conducting rapid-fire exercises, the group under instruction is paired off, coach and pupil, and placed on line. Full-sized targets are placed at 200 and 300 yards from the men under instruction, with some simple arrangement permitting the target to be exposed to view for the prescribed period of time. Rapid-fire exercises may be conducted at shorter ranges using targets proportionately reduced in size. Sights are set to correspond to the range being used. The commands and procedure are exactly the same as rapid fire on the rifle range except that practice dummy ammunition is used. For example, the pupil stands with sights properly set and blackened, sling adjusted on his arm, and with two clips of practice dummy cartridges in his belt. The instructor, after announcing the range and the position to be used, commands, 1. WITH DUMMY CARTRIDGES, LOAD, 2. READY ON THE RIGHT, 3. READY ON THE LEFT, 4. READY ON THE FIRING LINE, 5. CEASE FIRING, 6. UNLOAD. At the first command the rifles are loaded and locked. At the fourth command rifles are unlocked. When the target is exposed pupils take position rapidly and attempt to simulate firing 10 rounds, reloading from the belt. Upon completion of the exercise any cartridges remaining in the rifle are removed and the bolts left open. The sight leaf is immediately laid. During simulated firing the soldier should never take his eye from the target except to reload. He should count his

shots as he fires in order to know when the magazine is empty and thus avoid the loss of time incident to the effort of shoving the bolt forward when the follower blocks the bolt. The exercise is conducted from the standing position to the prone, sitting, and kneeling positions, and from the prone position rushing forward to the prone and kneeling positions.

*e. Duties of the coach.*—In a rapid-fire exercise the coach insures that—

- (1) The sights are blackened.
- (2) The gun sling is properly adjusted.
- (3) The correct position is taken.
- (4) The slack is taken up promptly.
- (5) The breath is held while aiming.
- (6) The trigger is squeezed properly.
- (7) The bolt is worked rapidly.
- (8) The eye is kept on the target, the elbows kept in place, and the butt of the rifle kept to the shoulder while working the bolt.
- (9) The magazine is reloaded quickly and without fumbling.

■ 30. FIFTH STEP—EFFECT OF WIND; SIGHT CHANGES; USE OF SCORE BOOK.—*a. Wind.*—(1) In firing at 600 yards or under, the effect of the weather conditions (except that of the wind) on the bullet can be disregarded. The influence of wind must be carefully studied.

(2) The horizontal clock system is used in describing the direction of the wind. The firing point is considered the center of the clock and the target is at 12 o'clock. A 3 o'clock wind comes directly from the right. A 6 o'clock wind comes straight from the rear. A 9 o'clock wind comes directly from the left. A wind that is constantly changing its direction back and forth is called a *fishtail wind*.

(3) The force of the wind is described in miles per hour. The force of the wind is estimated by throwing up light, dry grass, dust, or light paper and watching how fast it travels, by observing the danger flags, and by the mirage. In general, a light breeze is a 5 to 8 mile wind; a fairly strong breeze is a 10 to 12 mile wind. Wind blowing 20 miles an hour is very strong.

(4) Wind from either side blows the bullet out of its path. This must be allowed for by moving the rear sight toward the wind by means of the wind gage. The worst kind of a wind in which to shoot is a fishtail wind at 12 or 6 o'clock. The amount the bullet will be blown from its path depends on the force and direction of the wind and on the distance to the target.

(5) The amount of windage to allow for the first shot is shown in the wind-gage diagram in the score book. It can be found approximately by applying the wind rule.

(6) After the first shot is marked the correction necessary in windage is found by referring to the ruled targets in the score book showing the windage correction for each range. Windage corrections can also be estimated by applying the wind-gage rule given in *c* below.

*b. Wind rule.*—(1) The range (expressed in hundreds of yards) multiplied by the velocity of the wind and divided by 10 equals the number of quarter points to allow for a 3 o'clock or 9 o'clock wind. (M1906 ammunition.)

*Example:* At 500 yards the wind is blowing 8 miles per hour at 3 o'clock;  $\frac{5 \times 8}{10}$  equals 4 quarter points or 1 point of windage. The sight should have 1 point of right windage for the first shot.

(2) As the direction of the wind gets nearer and nearer to 12 or 6 o'clock the amount of windage necessary becomes less and less. Winds 1 hour away from 3 and 9 o'clock require only slightly less windage. Winds 1 hour away from 12 and 6 o'clock require almost half as much windage as 3 or 9 o'clock winds.

(3) Winds that are at 12 o'clock require no windage, but it is a very rare thing to have a steady wind from either 12 or 6 o'clock. Strong winds from 12 o'clock tend to retard the bullet a little, and winds from 6 o'clock tend to accelerate it, but the amount is so slight that a correction in elevation is very seldom necessary. At the most this allowance is very small.

*c. Wind-gage rule.*—(1) One point of windage moves the point of impact of the bullet 4 inches for each 100 yards of range. Thus 1 point of windage will move the hits 8



inches at 200 yards, 12 inches at 300 yards, and 20 inches at 500 yards. This rule is not exact but is near enough for all practical purposes.

(2) The point of impact of the bullet will move in the same direction as the rear sight is moved. For example, if it is desired to move the hits to the left, the rear sight must be moved to the left; if it is desired to make the hits strike lower and to the right, the rear sight must be moved down and to the right.

*d. Mirage.*—(1) Heat waves that can be seen near the ground are called *mirage*. The direction in which these waves are blowing and their speed are watched by good riflemen in judging the direction and velocity of the wind. The mirage is of assistance in judging the wind principally on bright days when there is a light, variable breeze.

(2) In a moderate wind the waves seem to race across the range and to lie close to the ground. In a light wind the waves do not lie so close to the ground and appear to move more slowly. In strong winds the mirage cannot be seen.

(3) When there is no wind or when the wind is at 12 or 6 o'clock the mirage seems to boil. The *boiling* of the mirage signifies that the wind is changing direction. The firer should wait until the mirage begins a steady flow from one side or the other before firing.

(4) Mirage can be seen much better with a field glass or telescope than with the eye alone.

*e. Elevation rule.*—(1) Changing the elevation 100 yards at any range will give a change on the target, in inches, equal to the square of the range (expressed in hundreds of yards).

*Example:* At 200 yards, changing the elevation 100 yards makes 4 inches change on the target; at 300 yards, 9 inches; at 500 yards, 25 inches; at 600 yards, 36 inches. This rule is not exact but is near enough for all practical purposes.

(2) The horizontal lines in the model targets in the score book also show how much change to make in the elevation at each range. When a change in elevation is necessary it is best to consult the model target in the score book before deciding how much of a change to make.

*f. Light.*—(1) Light has no effect on the bullet but does affect the aim. The effect of changes of light is very slight with most riflemen. The correction for variations in light does not exceed 25 yards in elevation at any range. The effect of changes of light is not uniform in its effect upon the aim of all riflemen.

(2) As a general rule men unconsciously aim a little lower in a poor light than in good light, and consequently need more elevation when the light is poor. This lowering of the aim is due to the fact that the outline of the bull's-eye is not distinct in a poor light; therefore men cannot hold as close to the bull's-eye and still be sure of their aim. As a rule poor lights exist on dark days when there is a haze in the air; on very bright, warm days, when there is a decided mirage; and when the sun is back of the target. The best light for shooting is when the sky is uniformly overcast and there is sufficient light to see the target clearly.

(3) Sunlight from one side has the same effect with most men as wind from that side. This is because the side of the front sight toward the sun is more clearly defined and unconsciously held under the center of the bull's-eye. Such holding places the bullet on the opposite side of the bull's-eye from the sun. The allowance of windage for sunlight varies from zero to almost one-half a point. In making this allowance the sight is moved toward the sun.

*g. Zero of a rifle.*—(1) The zero of a rifle for each range is the point at which the rear sight must be placed for both elevation and windage in order to hit the center of the bull's-eye on a normal day when there is no wind. This zero may not conform to the marks on the sight leaf and the wind gage. The zero of any one rifle may differ with different men, owing to the difference in their way of holding the rifle or of aiming.

(2) Each man must determine the zero of his own rifle for each range. He does this by studying the data which he has written in his score book concerning sight settings, sight changes, light, and the direction and velocity of the wind. The zero of a rifle is best ascertained on a day with an overcast sky when there is no wind. Having learned the zero of his rifle the rifleman computes all his windage and elevation

allowances for the first shot from this zero and not from the zero marked on the rifle sight, unless the two correspond.

*h. Shooting up or down hill.*—In shooting either up or down hill, less elevation is needed than when shooting on the level. The steeper the hill the less elevation is needed, so that when firing vertically up or down no elevation at all is needed, no matter how distant the target. Slight slopes that may be found on target ranges have no appreciable effect upon the elevation used and require no correction.

*i. Sight-setting and sight-changing exercises.*—In these exercises the instructor uses the full-sized A, B, and D targets, with spotters to indicate the position of the hits.

(1) The instructor assembles his squad or group, each pupil having his rifle, score book, and pencil and conducts the exercise as follows:

(a) Points out the wind gage and explains that each line or division represents one point of windage.

(b) Points out the graduations on the sight leaf and explains that the line directly under the number represents the range.

(c) Explains the effect of wind and cautions the class to disregard all atmospheric influences except wind.

(d) Explains the wind-gage diagram in the score book.

(e) Reads over and explains the wind rule, wind-gage rule, and the elevation rule. By asking questions he assures himself that these rules are understood.

(f) Explains the horizontal and vertical lines on the model targets in the score book and assures himself that each man understands the use of this diagram.

(g) Shows the pupils how to draw the elevation and wind-age lines for each range on the blank targets of the score book upon which they are to plot their shots during range firing.

(h) Having explained the foregoing points to the assembled group, the pupils are placed in pairs, and the instructor tests the ability of the members of the class to set the sights for the first shot by use of the wind rule or the wind-gage diagram. Every time the sights are set each pupil examines the sight of the pupil paired with him and tells the instructor, when called upon, the sight setting used.

(i) Instructor tests ability to change sights intelligently after first shot by referring to the horizontal and vertical lines on the model target.

(2) *Examples of sight-setting exercises.*

(a) "You are at 500 yards and estimate the wind to be 10 miles at 3 o'clock; set your sights for the first shot. Jones, what does Smith's sight read? Robinson, what should the sight read? Each man whose teammate did not set his sight at  $1\frac{1}{4}$  points right windage, hold up his hand." The instructor, by questions and explanations, assists the men who have made mistakes.

(b) "You are at 600 yards and estimate the wind to be 10 miles at 9 o'clock; set your sights for the first shot. Suppose you fired and the spotter marked the hit here (placing a spotter in the 4 space near the bull's-eye, at 3 o'clock) and you were sure your hold and trigger squeeze were good; change your sights to bring the next shot into the center of the bull's-eye. Johnson, what does William's sight read? Snider, what should the sight read? Each man whose teammate did not have his sight set at 2 points left windage, hold up his hand." The instructor assists those men who have made decided errors. Differences of less than one-fourth point are matters of opinion in applying the rules and are unimportant.

(3) The instructor gives a number of examples with the wind at different angles and velocities and at the various ranges until the class thoroughly understands the use of the wind gage.

(4) Following the instruction in the use of the wind gage, the instructor puts the class through similar exercises which require changes in elevation.

(5) The instructor gives a number of examples which require changes in both windage and elevation until the principles of sight changing are well understood by the class.

(6) Assuming the zero of the rifles to be away from the normal both as to windage and elevation, the instructor repeats the exercises.

(7) *Examples of other sight-setting exercises.*

(a) "Set your sight at 625 yards with  $1\frac{1}{2}$  points of left windage. Suppose you fire four shots hitting here (place

four spotters in the bull's-eye), and your fifth shot goes here (place spotter on 3 space at 11 o'clock). Jones, what are you going to do now? Jenkins, what are you going to do? You should not do anything to the sight. It is practically certain that you squeezed the trigger improperly and flinched. Not even a very sudden and violent change in the weather or light could cause nearly that much of a difference. Don't try to correct your own faults by changing the sights around."

(b) "For your first score in rapid fire at 200 yards you have set your sight at the same elevation and windage that you used in slow fire. Suppose this to be 200 yards elevation and zero windage and your group goes here (putting 10 spotters low and to the left). Set your sight to bring the next score into the figure. Miller, what does Wright's sight read?"

(8) A group in rapid fire should strike the same place as in slow fire. Rapid-fire groups that vary in position from slow-fire groups are due to imperfect trigger squeeze in rapid fire, and consequently these groups are more scattered. Men should endeavor to squeeze the trigger so that the rapid-fire sight settings will be the same. But if there is a constant variation in the two sight settings, each man should note it in his score book and set his sight in rapid fire so as to make the groups count as much as possible. Groups that are scattered all over the target cannot be corrected by changing the sight.

*j. Use of the score book.*—(1) Each man must keep a score book in which he records not only the value of the hits but the location of each hit, the sight setting and sight changes, the force and direction of wind, the kind of light, the hour, the date, and such other data as may be of use in the future. Spaces for these notes are provided on the score sheets of the score book.

(2) The use of the score book on the range is important for the following reasons:

(a) The plotting of the shots shows the firer the location of his group.

(b) The wind-gage diagram indicates the windage to take for the first shot. The model target shows by means of ver-

tical and horizontal lines the change in elevation and windage necessary to place the group in the center of the target.

(c) Plotting the shots and recording the data as to light and wind help the soldier to learn the zero of his rifle.

(d) The data written down as to sight settings and weather conditions while firing at any range are of great assistance in setting the sight correctly when again firing at that range. Where a number of scores have been fired and recorded, the firer should get his sight settings from previous scores fired on days that were similar as to light and wind.

(3) The score book will be kept personally by the man firing. The coach assists him when necessary to decide what to write down, but the coach will neither plot the shots nor enter any data.

*k. Score-book exercises.*—The squad or larger group is assembled in front of a full-sized B target, each man with score book, pencil, and rifle. The class is divided into pairs. Each man acts as coach for the other man of his pair.

(1) The instructor states the light and weather conditions and the range. He then indicates 10 successive shots on the target by means of a spotter and requires each man to plot each shot as it is indicated, write down the data given from time to time, and make the actual sight settings and corrections on his rifle. Weather and light conditions assumed by the instructor and changes announced during the exercise should be such as are likely to occur on the rifle range.

(2) The pupils are told by the instructor to open their score books at the first blank page and plot the shots and write in the data as given to them. They are further instructed to write lightly so that erasures may be made allowing the same page to be reused. The example as given will be substantially as follows:

(a) "You are at 600 yards on the rifle range. You are getting ready to fire a slow-fire score. There is bright sunlight. The wind varies from 8 to 12 miles an hour in velocity and from 1 to 3 o'clock in direction. When you are in position ready to fire the first shot, the wind seems steady at 3 o'clock and blowing about 8 miles an hour. Write in your data and set your sights. Jones, where has Robinson set his sight?"

Williams, where has Smith set his sight? You should have a scant  $1\frac{1}{4}$  points of right windage."

(b) "You fire your first shot and the spotter marks it here (put spotter a close 4 at 7 o'clock). Decide what you are going to do and set your sights. Dodd, what does McLean's sight read? You should have moved your sight about one-fourth a point to the right and raised it 25 yards so that your sight should read 625 yards and a scant  $1\frac{1}{2}$  or a strong  $1\frac{1}{4}$  of right windage."

(c) "Your second shot goes here (spotter near center of bull's-eye); your third shot goes here (spotter in bull's-eye near the top); your fourth shot goes here (spotter in bull's-eye near the bottom); your fifth shot goes here (close 4 at 9 o'clock). The wind seems to be a little stronger, but you are not sure. Your hold was all right. Johnson, what are you going to do? I would take half the correction called for by the model target. Set your sight accordingly. You should have about  $1\frac{3}{4}$  points of right windage now. Your sixth shot goes here (a bull's-eye near the edge at 3 o'clock). Malone, what are you going to do? The four on the fifth shot must have been due to an error in aim or trigger squeeze, so put your sight back to where it was before ( $1\frac{1}{2}$  points).

(d) "Before you fire your seventh shot you notice that the wind has shifted to about 1 o'clock but is still blowing at the same rate. Wilson, where has Simpson set his sight now? Billings, what does the book say about a 1 o'clock wind? You need almost half as much windage as for a 3 o'clock wind. You should now have almost  $\frac{3}{4}$  point of right windage. Set your sight there.

(e) "Your next shot goes here (a wide 4 at 6 o'clock). Collins, what correction has Brown made for his eighth shot? You should have made no change in your sight. Your windage is apparently correct and there has been no change in the conditions. Your low shot was due to a poor aim or a poor trigger squeeze. Do not try to correct your personal errors by moving your sight around. Your eighth shot goes here (bull's-eye); your ninth shot here (bull's-eye); your tenth shot goes here (bull's-eye). Write in your notes and exchange books with your teammate. Smith, has Williams

plotted all the shots correctly? Read the notes he has written in his book."

(3) The instructor corrects errors and mistaken ideas and makes a note of the pupils needing additional instruction.

■ 31. SIXTH STEP—EXAMINATION OF MEN BEFORE STARTING RANGE PRACTICE.—(The answers given herein are merely examples. Men should be required to explain them in their own words.)

Q. What is this (drawing a circle on the ground or on paper)? A. A circle.

Q. Where is the center of it? A. Here (pointing to the center).

Q. Suppose that circle represents a peep sight through which you are looking and that you are told to bring the top of the front sight to the center of it; where would the top of the front sight be? A. Here (pointing to the center of the circle).

Q. Make a mark in the circle to represent the front sight. Make a small circle to represent the bull's-eye. Is the bull's-eye in the center of the peep sight? A. No; the bottom edge of it is in the center.

Q. Why? A. Because the top of the front sight is in the center and just touches the bottom edge of the bull's-eye.

Q. Should the front sight be held up into the bottom of the bull's-eye? A. No; it just touches the bottom edge of the bull's-eye, so that all of the bull's-eye can still be clearly seen.

Q. What is this (indicating sighting bar)? A. Sighting bar.

Q. What is it for? A. To teach me how to aim.

Q. Why is it better than a rifle for this purpose? A. Because the sights on it are much larger and slight errors can be more easily seen and pointed out.

Q. What does this represent? A. The front sight.

Q. And this? A. The rear sight.

Q. What is this? A. The eyepiece.

Q. What is the eyepiece for? A. To cause me to place my eye in such a position as to see the sights in the same alinement as that set by the coach.



Q. Is there any eyepiece on the rifle? A. No; I learn by the sighting bar how the sights look when properly alined, and I must hold my head so as to see the sights the same way when aiming a rifle.

Q. How do you hold your head steadily in this position when aiming a rifle? A. By pressing my cheek firmly against the side of the stock.

Q. Where do you focus your eye when aiming a rifle? A. On the bull's-eye.

Q. Tell me what is wrong with these sights. (The instructor now adjusts the sights of the bar, making various slight errors; first, to show the correct and incorrect adjustments of the sights, and then, with the sights properly adjusted, he sights on the small bull's-eye to demonstrate correct and incorrect adjustments, requiring the man to point out any errors.)

Q. What is the difference between the way you aim with peep sight and the way you aim with an open sight? A. There is no difference. In both, the top of the front sight is brought to the center of the circle. With the open sight the top half of the circle is omitted, making it look as if the top half of the circle had been cut off and removed.

Q. Now, take this sighting bar and adjust the sights properly. (Verified by the instructor.)

Q. Now that the sights are properly adjusted, have the small bull's-eye moved until the sights are properly aimed at it.

Q. How do you breathe while aiming? A. After I get my sights lined up on the bull's-eye, I draw in a little more than an ordinary breath and let out a little, and hold the remainder while aiming and squeezing the trigger.

Q. Take the prone position, aim and simulate firing a shot at that mark. (The instructor must assure himself that the man knows how to hold his breath properly while aiming. Many men have great difficulty in learning to do this correctly.)

Q. What is this? A. An aiming device.

Q. What is it used for? A. To show the instructor how a man is aiming.

Q. Now, I will take this rifle, and with the aid of the sandbag rest to hold the rifle steady, I will aim at the bull's-eye, and you will watch the sights through the aiming device and tell me when my aim is right and when it is wrong, and what the error is when wrong. (The instructor now aims so as to illustrate the common faults and the man must observe and call attention to them.)

Q. I will now simulate firing at a bull's-eye a few times and you will watch through the aiming device and call where the shots would have hit.

Q. Now, take this rifle and, using the sandbag rest, aim at the bull's-eye, and I will watch you through the aiming device. (The instructor satisfies himself that the man understands sighting and aiming, and requires him to simulate firing a few times and to call his shots.)

Q. I will take the rifle and assume the kneeling, sitting, and prone positions, and position with sandbag rest, and you will tell me whether the position is correct or incorrect in each case. (The gun sling is adjusted in all these tests.)

Q. Take this rifle and show me your kneeling, sitting, and prone positions, and position with sandbag rest.

Q. Now show me how you take the sitting and prone positions rapidly from a standing position.

Q. How do you squeeze the trigger? A. I squeeze the trigger with such a steady increase of pressure that I do not know just when the rifle will go off.

Q. What do you know while you are squeezing the trigger? A. I know that the sights are lined upon the bull's-eye.

Q. If the sights are slightly out of alinement, what do you do? A. I hold the pressure I have on the trigger and only resume the increase of pressure when the sights become lined upon the bull's-eye again.

Q. If you do this, can your shot be a bad one? A. No.

Q. Why? A. Because I cannot flinch, for I do not know when to flinch, and the sights will always be lined up with the bull's-eye when the rifle goes off, because I never increase the pressure on the trigger, except when they are properly lined up.

Q. Is it necessary to take a long time to press the trigger in this way? A. No. The method of squeezing the trigger is slow at first but rapidity is developed by practice.

Q. How do you squeeze the trigger in rapid fire? A. I squeeze it the same way as in slow fire, with such a steady increase of pressure as not to know when the rifle will fire.

Q. In rapid fire how do you gain time so as not to be compelled to hurry in aiming and squeezing the trigger? A. I gain time by taking the position rapidly, working the bolt rapidly, and by keeping my eye on the target while working the bolt.

Q. How does keeping your eye on the target help you to gain time? A. A man who looks into the chamber while working the bolt always works it slowly so as to see the cartridges enter the barrel and he loses time in finding his own target again.

Q. What other fault, in rapid fire, comes from looking into the chamber while working the bolt? A. Firing on the wrong target.

Q. Show me how you work the bolt in rapid fire, prone, sitting, and kneeling.

Q. Now show me how you load a clip of service ammunition into the magazine.

Q. Is it important to get into the correct position before beginning to shoot in rapid fire? A. Yes; even though it takes more time, I should always get into the correct position before beginning to shoot.

Q. What is meant by *calling the shot*? A. To say where you think the bullet hit as soon as you shoot and before the shot is marked.

Q. How can you do this? A. By noticing exactly where the sights point when the rifle goes off.

Q. If a man cannot call his shot properly, what does it usually indicate? A. That he did not squeeze the trigger properly and did not know where the sights pointed at the time the rifle went off.

Q. What is this? A. A score book.

Q. What are these lines for (indicating the horizontal lines in the model target)? A. To show the amount of elevation necessary to bring the shot to the middle line.

Q. What are these lines for (indicating the vertical lines on the model target)? A. To show the amount of change in windage necessary to bring the shot to the middle line.

Q. If a shot hits here (indicating), what change in your sight would you make to bring the next shot to the center of the bull's-eye?

Q. What effect does moving your rear sight have on the shot? A. It moves it in the same direction as the rear sight moves.

Q. If you want to make a shot hit higher, what do you do? A. I increase my elevation.

Q. If you want to make your shots hit more to the right, what do you do? A. I move my rear sight to the right.

Q. If you move your rear sight one point of windage, how much will it move the point struck by the bullet? A. Four inches for each 100 yards of range.

Q. Explain what you mean by that.

Q. I will place this spotter on this target (full size 500-yard target) to represent a shot properly fired by you at 500 yards with zero windage and sight set at 500 yards. Take your rifle and move your sight to bring the next shot to the center of the bull's-eye. (Instructor now tests in various ways the man's ability to make proper sight corrections.)

Q. What are the three principal uses of the score book? A. To show me where my shot group is located, to indicate how much change in the sight is necessary, to move a shot or group of shots to the center of the target, and to make a record of the sight settings of my rifle for the different ranges under various weather conditions so that I will know where to set my sight when starting to shoot at each range under different weather conditions.

Q. Tell me what effect different light and weather conditions have on a man's shooting.

Q. In firing at ranges up to and including 600 yards, what is the only weather condition for which you make slight corrections? A. Wind.

Q. What three things do you do in cleaning a rifle after it has been fired? A. I first remove the powder fouling from the bore. I then dry the bore thoroughly of the liquid used

in removing the fouling. After this is done I grease the bore to protect it from rust.

Q. How do you remove the powder fouling from the bore?

A. By swabbing it thoroughly two or more times with cleaning patches saturated with water.

Q. How do you dry the bore? A. By running clean patches through the bore until it is thoroughly dry.

Q. How do you protect the bore from rust? A. By swabbing it thoroughly with a cleaning patch saturated with medium rust-preventive compound or oil issued for this purpose.

## SECTION III

## QUALIFICATION COURSES

■ 32. GENERAL.—See AR 775-10 for information as to who will fire the several courses, individual classification, qualification, ammunition allowances, etc.

■ 33. COURSE A.—*a. Instruction practice.*

TABLE I.—*Slow fire*

Range (inches)	Time	Shots	Target	Position	Sling
1,000	No limit	5	A 1,000-inch	Prone. Sandbag optional	Loop.
1,000	do.	5	do.	Prone	Loop or hasty.
1,000	do.	5	do.	Sitting	Do.
1,000	do.	5	do.	Kneeling	Do.
1,000	do.	5	do.	Standing	Do.

TABLE II.—*Rapid fire*

Range (inches)	Time (seconds)	Shots	Target	Position	Sling
1,000	60	15	D 1,000-inch	Prone from standing	Loop or hasty.
1,000	60	15	do.	Sitting or kneeling from standing.	Do.

<sup>1</sup> See par. 38c (2).

TABLE III.—*Slow fire*

Range (yards)	Time	Shots	Target	Position	Sling
200	No limit	5	A	Prone. Sandbag optional	Loop.
300	do	5	A	do	Do.
500	do	5	B	do	Do.

TABLE IV.—*Slow fire*

Range (yards)	Time	Shots	Target	Position	Sling
200	No limit	5	A	Prone	Loop.
300	do	5	A	do	Do.
500	do	10	B	do	Do.

TABLE V.—*Slow fire*

Range (yards)	Time	Shots	Target	Position	Sling
200	No limit	5	A	Sitting	Loop.
200	do	5	A	Kneeling	Hasty.
200	do	5	A	Standing	Do.

TABLE VI.—*Rapid fire*

Range (yards)	Time (seconds)	Shots	Target	Position	Sling
200	60	1 5	D	Kneeling from standing	Loop or hasty.
300	70	1 5	D	Prone from standing	Do.

<sup>1</sup> See par. 38 c (2).

TABLE VII.—*Rapid fire*

Range (yards)	Time (seconds)	Shots	Target	Position	Sling
200	70	1 5	D	Kneeling from prone, running 25 yards.	Loop or hasty.
300	80	1 5	D	Prone from prone, running 25 yards.	Do.

<sup>1</sup> See par. 33c (2).

*b. Record practice.*TABLE VIII.—*Slow fire*

Range (yards)	Time	Shots	Target	Position	Sling
200...	No limit.	10	A.....	5 standing, 5 kneeling.....	Hasty.
500...	do.....	10	B.....	Prone.....	Loop.

TABLE IX.—*Rapid fire*

Range (yards)	Time (seconds)	Shots	Target	Position	Sling
300...	70.....	10	D.....	Prone from standing.....	Loop.

TABLE X.—*Rapid fire*

Range (yards)	Time (seconds)	Shots	Target	Position	Sling
200...	70.....	10	D.....	Kneeling from prone, running 25 yards.	Loop or hasty.
300...	80.....	10	D.....	Prone from prone, running 25 yards.	Do.

NOTE.—When a distance of 25 yards is not available, a shorter distance may be used, reducing the time 2 seconds for each 5 yards.

■ 34. COURSE B.—*a. Instruction practice.*TABLE I.—*Slow fire*

Range (inches)	Time	Shots	Target	Position	Sling
1,000.	No limit	5	A 1,000-inch.	Prone. Sandbag optional...	Loop.
1,000.	do.....	5	do.....	Prone.....	Loop or hasty.
1,000.	do.....	5	do.....	Sitting.....	Do.
1,000.	do.....	5	do.....	Kneeling.....	Do.
1,000.	do.....	5	do.....	Standing.....	Do.

TABLE II.—*Rapid fire*

Range (inches)	Time (seconds)	Shots	Target	Position	Sling
1,000.	60.....	1 5	D 1,000-inch.	Prone from standing.....	Loop or hasty.
1,000.	60.....	1 5	.....do.....	Sitting or kneeling from standing.	Do.

<sup>1</sup> See par. 38c (2).

TABLE III.—*Slow fire*

Range (yards)	Time	Shots	Target	Position	Sling
200...	No limit.	5	A.....	Prone. Sandbag optional...	Loop.
300...	.....do.....	5	A.....	.....do.....	Do.

TABLE IV.—*Slow fire*

Range (yards)	Time	Shots	Target	Position	Sling
300...	No limit.	5	A.....	Sitting.....	Loop.
300.....	.....do.....	5	A.....	Kneeling.....	Hasty.
200.....	.....do.....	5	A.....	Standing.....	Do.

TABLE V.—*Rapid fire*

Range (yards)	Time (seconds)	Shots	Target	Position	Sling
200...	60.....	1 5	D.....	Kneeling from standing.....	Loop or hasty.
300...	70.....	1 5	D.....	Prone from standing.....	Do.

<sup>1</sup> See par. 38 c(2).

TABLE VI.—*Rapid fire*

Range (yards)	Time (seconds)	Shots	Target	Position	Sling
200...	70.....	1 5	D.....	Prone from prone, running 25 yards.	Loop or hasty.
300...	80.....	1 5	D.....	.....do.....	Do.

<sup>1</sup> See par. 38c (2).



## b. Record practice.

TABLE VII.—*Slow fire*

Range (yards)	Time	Shots	Target	Position	Sling
200...	No limit.	5	A .....	Standing .....	Hasty.
300...	do .....	10	A .....	Kneeling .....	Loop or hasty.

TABLE VIII.—*Rapid fire*

Range (yards)	Time (seconds)	Shots	Target	Position	Sling
300...	70 .....	10	D .....	Prone from standing .....	Loop.

TABLE IX.—*Rapid fire*

Range (yards)	Time (seconds)	Shots	Target	Position	Sling
200...	70 .....	10	D .....	Prone from prone, running 25 yards.	Loop or hasty.
300...	80 .....	10	D .....	do .....	Do.

NOTE.—When a distance of 25 yards is not available, a shorter distance may be used, reducing the time 2 seconds for each 5 yards.

## ■ 35. COURSE C.—a. Instruction practice.

TABLE I.—*Slow fire*

Range (inches)	Time	Shots	Target	Position	Sling
1,000.	No limit.	5	A 1,000-inch.	Prone, sandbag optional.	Loop.
1,000.	do .....	5	do .....	Prone .....	Loop or hasty.
1,000.	do .....	5	do .....	Sitting .....	Do.
1,000.	do .....	5	do .....	Kneeling .....	Do.
1,000.	do .....	5	do .....	Standing .....	Do.

TABLE II.—*Rapid fire*

Range (inches)	Time (seconds)	Shots	Target	Position	Sling
1,000.	60.....	15	D 1,000-inch.	Prone from standing.....	Loop or hasty.
1,000.	60.....	15	.....do.....	Sitting or kneeling from standing.	Do.

<sup>1</sup> See par. 38c (2).

TABLE III.—*Slow fire*

Range (yards)	Time	Shots	Target	Position	Sling
200...	No limit.	5	A.....	Prone. Sandbag optional...	Loop.
200...	do.....	5	A.....	Prone.....	Do.
200...	do.....	5	A.....	Sitting.....	Do.
200...	do.....	5	A.....	Kneeling.....	Hasty.
200...	do.....	5	A.....	Standing.....	Do.

TABLE IV.—*Rapid fire*

Range (yards)	Time (seconds)	Shots	Target	Position	Sling
200...	60.....	15	D.....	Kneeling from standing.....	Loop or hasty.
200...	70.....	15	D.....	Prone from prone, running 25 yards.	Do.

<sup>1</sup> See par. 38c (2).

**b. Record practice.**

TABLE V.—*Slow fire*

Range (yards)	Time	Shots	Target	Position	Sling
200...	No limit.	5	A.....	Kneeling.....	Loop or hasty.
200...	do.....	5	A.....	Standing.....	Hasty.

TABLE VI.—*Rapid fire*

Range (yards)	Time (seconds)	Shots	Target	Position	Sling
200.....	60.....	10	D.....	Kneeling from standing.....	Loop or hasty.
200.....	70.....	10	D.....	Prone from prone, running 25 yards.	Do.

NOTE.—When a distance of 25 yards is not available, a shorter distance may be used, reducing the time 2 seconds for each 5 yards.

■ 36. COURSE D.—*a. Instruction practice.*

TABLE I.—*Slow fire*

Range (inches)	Time	Shots	Target	Position	Sling
1,000.	No limit.	10	A 1,000-inch.	Prone. Sandbag optional....	Loop.
1,000.	do.....	10	do.....	Prone.....	Loop or hasty.
1,000.	do.....	10	do.....	Sitting.....	Do.
1,000.	do.....	10	do.....	Kneeling.....	Do.
1,000.	do.....	10	do.....	Standing.....	Do.

TABLE II.—*Rapid fire*

Range (inches)	Time (seconds)	Shots	Target	Position	Sling
1,000.	60.....	1 5	D 1,000-inch.	Prone from standing.....	Loop.
1,000.	60.....	1 5	do.....	Sitting or kneeling from standing.	Loop or hasty.
1,000.	70.....	1 5	do.....	Prone from prone, running 25 yards.	Do.

<sup>1</sup> See par. 38c (2).

*b. Record practice.*

TABLE III.—*Slow fire*

Range (inches)	Time	Shots	Target	Position	Sling
1,000.	No limit.	5	A 1,000-inch.	Kneeling.....	Loop or hasty.
1,000.	do.....	5	do.....	Standing.....	Hasty.

TABLE IV.—*Rapid fire*

Range (inches)	Time (seconds)	Shots	Target	Position	Sling
1,000.	60.....	10.	D 1,000-inch.	Kneeling from standing.....	Loop.
1,000.	70.....	10	.....do.....	Prone from prone, running 25 yards.	Loop or hasty.

NOTE.—When a distance of 25 yards is not available, a shorter distance may be used, reducing the time 2 seconds for each 5 yards.

## SECTION IV

## RANGE PRACTICE

■ 37. GENERAL.—*a. Phases.*—Range practice is initiated immediately after completion of the preparatory training. Range practice is divided into two parts—instruction practice and record practice.

*b. Sequence of practice.*—The practice season opens with instruction practice. Each person will complete instruction practice before he proceeds with record practice. When record practice is once begun by an individual it is completed before any other practice is permitted. As a rule, record practice will not be fired by any rifleman on the same day that he fires any part of instruction practice. However, when the time allotted to range practice is very limited, the officer in charge of firing may authorize record firing on the same day. Instruction practice and record practice will not be conducted simultaneously except on ranges where the firing points are in echelon or where the two types of practice are conducted on different parts of the same range.

*c. Range personnel.*—(1) *Officer in charge of firing.*—An officer in charge of firing will be designated by the responsible commander. It is desirable that he be the senior officer of the largest organization occupying the range. The officer in charge of firing, or his deputy, will be present during all firing and will be in charge of the practice and safety precautions on the range.

(2) *Range officer.*—The range officer is appointed by the post commander and is responsible to the latter for main-

taining and assigning ranges, for designating danger zones, and for closing roads leading into danger zones. The range officer makes timely arrangements for material and labor to place the ranges in proper condition for range practice. He directs and supervises all necessary repairs to shelters, butts, targets, firing points, and telephone lines. He provides for the safety of the markers, and when necessary he provides range guards and instructs them in the methods to be used for the protection of life and property within the danger area. He assists the officer in charge of firing by using the means necessary to provide efficient service from the maintenance personnel of the ranges.

(3) *Range noncommissioned officer.*—A noncommissioned officer and such assistants as the post commander may deem necessary will be detailed permanently during the range practice season as assistant to the range officer. He is responsible to the range officer that the target and pit equipment is kept in a serviceable condition; that the desired targets are ready for use at the appointed time; and that all target and pit details are provided with the proper flags, marking disks, pasters, and spotters.

(4) *Pit details.*—Commanders of organizations firing will provide such detail of officers, noncommissioned officers, and privates as may be necessary to supervise, operate, mark, and score the targets used by their respective organizations. (See par. 38 g.)

*d. Uniform.*—The uniform to be worn during instruction practice and record practice will be prescribed by the commanding officer.

*e. Pads.*—Men will be required to wear pads on the shoulder and, if the ground is hard, on the elbows for the first 3 or 4 days at least. A pad can easily be improvised by putting a pair of woolen socks under the shirt so as to protect the shoulder and the upper muscles of the arm. After a few days of firing the muscles become hardened so that the pads are not essential. (See par. 39 h(10).)

*f. Cartridge belt.*—The cartridge belt will be worn during instruction practice and record firing.

*g. Safety precautions.*—(1) Bolts of rifles in rear of the firing line will be kept open.

(2) Rifles will not be loaded in rear of the firing line.

(3) In rapid fire preceded by a run rifles will not be unlocked until the firer reaches the firing point and is in the prescribed firing position. (See par. 39 *f*(3).)

(4) Loaded rifles will always be pointed in the general direction of the targets.

(5) On open 1,000-inch ranges having no danger area behind the backstop, all loading and unloading will be executed with the muzzle directed toward the target, and in rapid fire rifles will not be unlocked until the firer is in the prescribed firing position.

(6) Ammunition at the firing point should be protected from the direct rays of the sun.

(7) At the completion of each day's firing, and preferably before leaving the range, organization commanders should cause all rifles and personnel to be inspected to insure that rifles are clear of ammunition and that no ammunition is in the possession of individuals.

(8) See AR 45-30 for regulations covering report of accident involving ordnance matériel.

■ 38. INSTRUCTION PRACTICE.—*a. General.*—Instruction practice represents the application with service ammunition of the principles taught in the preparatory training. The instruction practice outlined for each course described in paragraphs 33 to 36, inclusive, is designed to serve as a guide only. Only the general plan of beginning the practice at all ranges with the sandbag rest need be followed. Within authorized ammunition allowances the number of shots to be fired at each range is discretionary with the organization commander. The amount of instruction practice is not limited to that outlined in the tables. Such additional practice as time and ammunition allowances permit should be given.

*b. Slow fire.*—The first few shots fired on the range by beginners will be slow fire from the prone position with the sandbag rest; following this, slow fire from other positions is conducted. The sandbag rest is used at the beginning of the course, not to teach steadiness of hold but to facilitate instruction in the proper method of squeezing the trigger. The sandbag assures such a steady hold that the temptation of the beginner to snap in his shot at the instant the sight

touches or drifts past the bull's-eye, which is the cause of nearly all poor shooting, is eliminated. With the sandbag rest the sights can be held fixed at the bottom of the bull's-eye while the firer squeezes the trigger with such a steady pressure as not to know exactly when the rifle will fire, which is the basis of all good shooting. The habit of the correct trigger squeeze having been acquired by firing with a sandbag rest will in all probability be retained while firing prone and in the more unsteady positions—sitting, kneeling, and standing.

*c. Rapid fire.*—(1) During rapid fire the tendency to jerk the trigger, and consequently to flinch, is very strong. This tendency must be corrected before it can become a fixed habit.

(2) The tendency to flinch is eliminated by using clips in which half the cartridges are range dummy. The dummy and live cartridges are put into the clips by the coach in such a way that the pupil cannot know which will go off and which will not. Then, if he is not squeezing the trigger with a steady pressure he will flinch or shove the shoulder forward to meet the shock, when there is a dummy in the chamber and no shock occurs. The flinch is then apparent to the coach and to everyone in the vicinity, including the man doing the finching. The result is that he makes a determined effort to squeeze the trigger with a steady pressure for all shots, so as not to appear foolish both to the observers and to himself. During this kind of practice the coach must watch the firer closely to see that he does not look into the chamber in an attempt to see which cartridges are loaded and which are dummies. If he is allowed to look into the chamber while working the bolt, the value of the practice is lost and a very bad shooting habit is acquired.

(3) Range dummy cartridges, very similar in appearance to the service ammunition, are issued by the Ordnance Department for this purpose. They are issued to use on the rifle range with loaded cartridges, and this is the only use of them which is permitted. Practice dummy cartridges of such shape and color as to be readily distinguished from the service cartridge must be used in all other exercises requiring the use of dummy cartridges.

(4) It is advisable to have each order, when it comes to the firing point, simulate a score of rapid fire, using dummy cartridges or having the cut-off turned down.

*d. Coaching.*—(1) *General.*—During instruction practice the soldier works under the supervision of a coach. This does not mean that each man must have an experienced shot beside him. Any man of intelligence who has been properly instructed in the preparatory work and who has been given instruction in coaching methods can be used with good results and should be used when more experienced shots are not available. It is good practice to have expert coaches in charge of one or more targets, usually on a flank, to which particularly difficult pupils are sent for special coaching. Great patience should be exercised by the coach so as not to excite or confuse the firer.

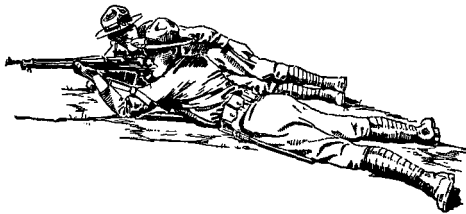

FIGURE 23.—Position of the coach.

(2) *Position of the coach.*—On the firing line the coach will take a position similar to that of the man who is firing—prone, sitting, kneeling, or standing—so as to be able to watch his trigger finger and his eye. In the later stages of instruction firing, the coach may be withdrawn from the firing line to observe his pupil from a point in rear; this affords him an opportunity to observe the pupil's performance while the latter is working alone, as will be the case in record practice. The pupil's errors should be noted and brought to his attention at the completion of the score. In exercises involving a rush, the coach follows his pupil to the firing line.

(3) *Watching the eye.*—Errors in trigger squeeze, which are the most serious and the hardest to correct, can be de-



tected by watching the pupil's eye. If his eye can be seen to close as the rifle goes off, it is because he knew when it was going off and consequently was not squeezing the trigger properly. The explosion and the shock will cause a man to wink, but this wink cannot be seen, due to the sudden movement of the head that takes place at the same time. If the firer can be seen to wink it is because he winked first and jerked the trigger afterward.

(4) *Use of dummy cartridges in slow fire.*—If the pupil is seen to be flinching, or if he is doing poor or mediocre shooting, the coach first checks his aim by the aiming device. Having assured himself that the pupil is aiming correctly, the coach has him turn his head aside while he, the coach, puts in a cartridge and shoves the bolt home. Occasionally the coach loads in a dummy cartridge instead of a live one without letting the pupil know what he has done. Then the

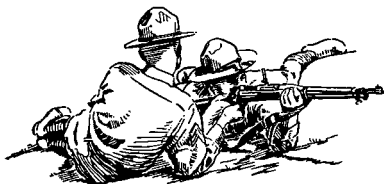

FIGURE 24.—Coach squeezing trigger.

flinch, indicated by the shoulder being shoved forward at the same time that the trigger is pressed, will be evident even to the firer himself. The coach then proves to him by squeezing the trigger a few times, as explained in (5) below, that his poor shooting is due to faulty trigger squeeze.

(5) *Coach squeezing the trigger.*—(a) To squeeze the trigger for the firer, the coach lies with his right elbow on the ground to steady his hand, places his thumb against the trigger, and his first finger against the back of the trigger guard. In this way he can apply pressure to the trigger by a pinching action of his thumb and first finger.

(b) The coach then watches the firer's back, and between 5 and 10 seconds after the firer begins to hold his breath he applies enough pressure to discharge the piece. Shots fired

in this way are almost always accurately placed. After discharging the piece a few times the coach lets the firer try a few shots alone, to see if he can press the trigger the same way the coach pressed it, so as not to know just when the rifle will go off. Sometimes it is necessary to repeat this exercise, but the majority of beginners can be permanently cured of the tendency to flinch by a few minutes of this kind of coaching. Old shots who are flinchers require more time and patience.

(6) *Duties of coach in slow fire.*—(a) The coach observes the pupil carefully and corrects all errors. He pays particular attention to see—

1. That the sights are blackened and that they are set at the correct range.
2. That the ammunition is free from dirt.
3. That the pupil has the correct position, gun sling properly adjusted, body at the proper angle, elbows correctly placed, and the cheek pressed firmly against the stock.
4. That the magazine is loaded from a clip in the correct manner.
5. That the slack is taken up promptly.
6. Whether or not the pupil flinches (by watching his eye).
7. That the pupil calls his shot each time he fires.
8. That the pupil keeps his score book correctly.
9. That the pupil is holding his breath properly (by watching his back occasionally).
10. That the aiming is correct (by watching through the aiming device occasionally).

(b) When necessary, the coach applies the coaching methods described in (4) and (5) above.

(7) *Duties of the coach in rapid fire.*—(a) The coach observes the pupil carefully and corrects all errors. He pays particular attention to see—

1. That the sights are blackened and that they are set at the proper range.
2. That the gun sling is properly adjusted.
3. That the pupil assumes the correct position.
4. That he takes up the slack promptly.

5. Whether or not the pupil finches (by watching his eye).
6. That he works the bolt rapidly.
7. That while working the bolt the pupil keeps his eye on the target, the rifle to his shoulder, and his elbows in place.
8. That he reloads the magazine from a clip properly and quickly.

(b) These operations follow each other, and the coach can watch each in turn. The coach will also at times watch the pupil's back to see if he holds his breath while firing each shot.

(c) Any lack of a smooth and rapid bolt operation indicates that the preparatory training has not been sufficient, and additional preparatory rapid-fire practice will be given.

*e. Individual precautions.*—(1) *Slow fire.*—The pupil should take the following precautions during every slow-fire score:

(a) Be sure that both the front and rear sights of the rifle are properly blackened.

(b) Be sure that the rear sight is properly set for the first shot.

(c) Take the score book to the firing point.

(d) Fire the first shot very carefully and then, if necessary, change the sights to bring the second shot into the bull's-eye.

(e) Aim at the bottom edge of the bull's-eye for every shot.

(f) Plot each shot in the score book.

(g) Never try to make a bullet hit closer to the bull's-eye by changing the aiming point; do so by changing the setting of the rear sight.

(h) Before changing the sight setting, note the setting on the sights and determine the amount of change required from a study of the shots plotted in the score book. Record the corrected sight setting.

(i) Do not change the sights unnecessarily. If a bad shot is made closely following several good shots it is almost certain to be the fault of the firer.

(2) *Rapid fire.*—In rapid-fire practice the pupil should insure that his sights are blackened and properly set. Upon completion of a score he should carefully plot each shot in the

score book and promptly record any changes in sight setting that may be necessary to center the group in the bull's-eye.

*f. Use of instruments.*—The use of field glasses, telescopes, sight-setting instruments, and instruments or devices for determining the force and direction of the wind is authorized and encouraged during instruction practice.

*g. Procedure prescribed in paragraph 39 for record practice is applicable to instruction practice with the following exceptions:*

(1) Scores are not required to be kept in the pits.

(2) Only such officers and noncommissioned officers are on duty in the pit as are necessary to preserve order and insure efficient pit service.

(3) The manner in which the scores are kept on the firing line is discretionary with the organization commander.

■ 39. RECORD PRACTICE.—*a. General.*—(1) The purpose of record practice is to test the soldier's skill as a rifleman and to determine his qualification. The qualification courses are prescribed in section III.

(2) The sequence in which the scores are fired in record practice is discretionary with the officer in charge of firing.

(3) Whenever practicable during record practice such officers as may be required for duty in the pit will be detailed from troops not firing.

*b. Organization of the firing line.*—(1) *General.*—The firing line will be organized so as to insure the safe and orderly conduct, and to facilitate supervision, of the firing, by the officer in charge of firing and his assistants. The distances specified in (2) below should be used as a guide only and may be modified at the discretion of the officer in charge of firing to meet local conditions.

(2) *Establishments.*—(a) Scorers stationed in rear of the firing line and close to the soldier being scored.

(b) Starting line 25 yards in rear of the firing point; a shorter distance may be used if 25 yards are not available.

(c) Telephone operators 5 yards in rear of the starting line.

(d) Soldiers awaiting their turn to fire (*ready line*), 5 yards in rear of the line of telephone operators.

(e) Rifle rests and cleaning racks 10 yards in rear of the ready line.

(3) During firing which does not involve the 25-yard run, the lines mentioned in (c), (d), and (e) above should be moved forward so that the line of telephone operators is about 10 yards in rear of the firing line.

(4) Individuals who are to fire will be assigned targets and the order in which they will take turn in firing the several scores, i. e., *1st order*, *2d order*, etc.

*c. Pit details.*—The details for the supervision, operation, marking, and scoring of targets during record practice consist of officers, noncommissioned officers, and privates, as follows:

(1) One commissioned officer assigned to each two targets. When it is impracticable to detail one officer to each two targets in the pit, an officer will be assigned to supervise the marking and scoring of not to exceed four targets. In this case the pit scores will be kept by the noncommissioned officer in charge of each target, who will sign the score card. The officer will take up and sign each score card as soon as a complete score is recorded.

(2) One noncommissioned officer assigned to each target to direct and supervise the markers. This noncommissioned officer will be selected from a company or other organization other than the one firing on the target which he supervises. If this is not possible the officer assigned to the target will exercise special care to insure correct scoring.

(3) One or two privates assigned to operate and mark each target. These privates may be selected from the organization firing on the target to which they are assigned.

*d. Score cards and scoring.*—(1) Two score cards will be kept, one at the firing point (W. D., A. G. O. Form No. 83) and one in the pit (W. D., A. G. O. Form No. 83-1).

(2) Entries on all score cards will be made in ink or with indelible pencil. No alteration or correction will be made on the card except by the organization commander, who will initial each alteration or correction made.

(3) The scores at each firing point will be kept by a non-commissioned officer of some organization other than that firing on the target to which he is assigned. If this is not possible company officers will exercise special care to insure correct scoring. As soon as a score is completed the score card will be signed by the scorer, taken up and signed by the

officer supervising the scoring, and turned over to the organization commander. Except when required for entering new scores on the range, score cards will be retained in the personal possession of the organization commander.

(4) In the pit the officer keeps the scores for the targets to which he is assigned. As soon as a score is completed he signs the score card. He turns these cards over to the organization commander at the end of the day's firing. The organization commander will check the pit records against the firing line records. In case of discrepancy between the two records the provisions of paragraph 1b, AR 345-1000, will apply.

(5) Upon completion of record firing and after the qualification order is issued, the pit score cards of each man will be attached to his official score card kept at the firing point. For records and reports of qualification see AR 345-1000.

*e. Marking.*—(1) *Slow fire.*—(a) The value of the shot is indicated as follows:

1. A bull's-eye, with a white disk.
2. A four, with a red disk.
3. A three, with a black and white disk.
4. A two, with a black disk.
5. A miss or a ricochet hit, by waving a red flag across the front of the target.

(b) The exact location of the hit is indicated by placing in the shot hole a spotter of size appropriate to the distance from the firing point. The center of the marking disk is placed over the spotter in signaling hits. No spotters are required on 1,000-inch ranges.

(2) *Rapid fire on target D.*—(a) The same disks are used to indicate the value of hits as in slow fire.

(b) Spotters are placed in the shot holes before the target is run up for marking.

(c) The marking begins with the hits of highest value, the center of the disk being placed over the spotter, then swung off the target and back again to the next spotter, care being taken each time to show only the face of the disk indicating the value of the shot being marked. The marking will be slow enough to avoid confusing the scorer at the firing point. When one spotter covers more than

one shot hole the disk is placed over it the required number of times. Misses and ricochet hits are indicated by slowly waving the red flag across the face of the target one time for each miss or ricochet hit.

*f. Procedure.—(1) Slow fire.—(a) On the firing line.*

1. One person only will be assigned to a target in each order.
2. The scorer, as the value of each shot is signaled, announces in a tone sufficiently loud to be heard by the firer the name of the firer, the number of the shot, and the value of the hit, and records the value of the hit on the score card of the individual who is firing.
3. Whenever a target is marked without the individual assigned to that target having fired, as will occur when someone fires on the wrong target, the scorer will notify the officer in charge, who will notify the officer assigned to that target in the pit to disregard the shot. This precaution is necessary to prevent errors in the pit record.
4. When an individual fires on the wrong target he will not be scored a miss until the target to which he is assigned has been pulled down and the miss signaled from the pit.
5. If the target is not half masked at the completion of a score on that target, or if it is half masked at the wrong time, the officer in charge of that firing point will adjust the matter at once over the telephone. This precaution is necessary to prevent the error from being carried on through the scores that follow.

*(b) In the pit.*

1. The target is withdrawn and marked after each shot, except that on 1,000-inch ranges the targets are marked and removed after each 5 or 10 shots and replaced with new targets.
2. When a shot is fired at a target it is pulled down. The noncommissioned officer makes a pencil mark across the shot hole and indicates the location of the hit to the officer. The officer an-

nounces its value and records it on the score card. A spotter is then placed in the shot hole. The previous shot hole, if any, is pasted, and the target is run up and marked. The noncommissioned officer supervises the marking of each shot. The officer also exercises general supervision over the marking.

3. When the pit score card indicates that a score has been completed, the target is half masked for about 30 seconds as a signal of such completion to the firing line. At the end of the 30 seconds the target is pulled fully down, the spotter removed, the shot hole pasted, and the target run up for the beginning of a new score.
  4. When a target frame is used as a counterweight for a double sliding target, the blank side of such frame will be toward the firing line.
- (2) *Rapid fire on target D.—(a) On the firing line.*
1. One person only will be assigned to a target in each order. The loop or hasty sling as required may be adjusted on the arm prior to the start of the exercise.
  2. When all is ready in the pit a red flag is displayed at the center target. At that signal the officer in charge of the firing line commands: **LOAD**. The rifles are loaded and locked.
  3. The officer in charge of the firing line then calls so that all may hear, "Ready on the right?" "Ready on the left?" Anyone who is not ready calls out, "Not ready on No. —."
  4. All being ready on the firing line, the officer in charge commands: **READY ON THE FIRING LINE**. Rifles are unlocked and the position of **READY** assumed. The telephone orderly notifies the pit, "Ready on the firing line."
  5. The flag at the center target is waved and then withdrawn. Five seconds after the flag is withdrawn the targets appear, remain fully exposed for the prescribed period of time, and are then withdrawn. The firer takes the prescribed posi-



- tion as soon as the targets appear and fires or attempts to fire 10 shots, reloading from a full clip taken from the belt. If any individual fails to fire at all he will be given another opportunity.
6. As soon as the targets are withdrawn the officer in charge commands: UNLOAD. All unfired cartridges are removed from the rifle and the bolts are left open. The men remain in position on the firing line until they are ordered off by the officer in charge.
  7. As each shot is signaled it is announced as follows: "Target No. —, 1 five, 2 fives, 3 fives, 1 four, 2 fours, 3 fours, 4 fours, 1 three, 1 miss, 2 misses." The scorer notes these values on a pad and watches the target as he calls the shot. After the marking is finished he counts the number of shots marked and if more or less than 10 calls "Re-mark No. —." If 10 shots have been marked he then enters the score on the soldier's score card and totals it as follows: 5 5 5 4 4 4 4 3 0 0 equals 34.
- (b) *In the pit.*
1. The time is regulated in the pit by the officer in charge.
  2. When all is ready in the pit the targets are fully withdrawn and a red flag is displayed at the center target.
  3. When the message is received that the firing line is ready, the red flag at the center target is waved and withdrawn and the command READY is given to the pit details.
  4. Five seconds after the red flag is withdrawn the targets, by command or signal, are run up, left fully exposed for the prescribed period of time, and then withdrawn.
  5. The officers in the pit examine each of their targets in turn, announce the score, and record it on the pit score card. Spotters are then placed in the shot holes and the targets run up and marked. The noncommissioned officer supervises the

marking of each shot. The officer exercises general supervision over the marking.

6. The targets are left up for about 1 minute after being marked and are then withdrawn, pasted, and made ready for another score. They may be left up until ordered pasted by the officer in charge of the firing line.
7. If more than 10 hits are found on any target it will not be marked unless all of the hits have the same value. The officer in charge of the firing line will be notified of the fact by telephone.

(3) *Rapid fire (preceded by a run).*—(a) *On the firing line.*

1. One person only will be assigned to a target in each order. The order will be at the starting line with sight leaf down, loop or hasty sling, as desired, adjusted.
2. When all is ready in the pit a red flag is displayed at the center target. At that signal the officer in charge of the firing line commands: **LOAD.** The rifles are loaded and locked. The officer in charge of the firing line commands: **LIE DOWN.**
3. The officer in charge of the firing line then calls so that all may hear, "Ready on the right? Ready on the left?" Anyone who is not ready calls out, "Not ready on No. —."
4. All being ready on the firing line, the officer in charge commands: **READY ON THE FIRING LINE.** The telephone orderly notifies the pit, "Ready on the firing line."
5. The flag at the center target is waved and then withdrawn. The officer in charge of the firing line commands: **PREPARE TO RUSH.** Five seconds after the flag is withdrawn the targets appear and the officer in charge of the firing line commands: **UP.** The firers move forward at a run and upon arrival at the firing point assume the firing position and fire or attempt to fire 10 shots, reloading from a full clip taken from the belt. The targets remain fully exposed for the

prescribed period of time and are then withdrawn. If any individual fails to fire at all, he will be given another opportunity, but if he fires any shots the score must stand as his record. He will not be permitted to repeat his score on the claim that he was not ready. (See *h* (21) and (23) below.)

6. As soon as the targets are withdrawn the officer in charge commands: **UNLOAD**. All unfired cartridges are removed from the rifle and the bolts are left open. The men remain in position on the firing line until they are ordered off by the officer in charge.
7. As each shot is signaled it is announced as follows: Target No. —, 1 five, 2 fives, 3 fives, 4 fives, 5 fives, 6 fives, 7 fives, 8 fives, 2 misses. The scorer notes these values on a pad and watches the target as he calls the shot. After the marking is finished he counts the number of shots marked and if more than 10 calls "Re-mark No. —." If 10 shots have been marked he then enters the score on the soldier's score card and totals it as follows: 5 5 5 5 5 5 5 0 0 equals 40.

(b) *In the pit.*

1. The time is regulated in the pit by the officer in charge.
2. When all is ready in the pit a red flag is displayed at the center target.
3. When the message is received that the firing line is ready, the red flag at the center target is waved and withdrawn and the command **READY** is given to the pit details.
4. Five seconds after the red flag is withdrawn, the targets by command or signal are raised, left fully exposed for the prescribed period of time, and then withdrawn.
5. The officers in the pit examine each of their targets in turn, announce the score, and record it on the pit score card. The targets are then raised and marked. The noncommissioned officer supervises

the marking of each shot. The officer exercises general supervision over the marking.

6. After being marked, the targets are lowered, pasted, and made ready for another score. They may be left up until ordered pasted by the officer in charge of the firing line.
7. If more than 10 hits are found on any target the officer in charge of the firing line will be notified of the fact by telephone. (See *h* (24) below.)

(4) *Rapid fire on target D (rifle) 1,000-inch range.—(a) 1,000-inch range with target pit.*

1. Rapid fire from standing position to prone, sitting, and kneeling will be conducted in the same manner as prescribed for target D, except that the miniature targets will be removed and replaced with new targets after marking.
2. Rapid fire preceded by a run will be conducted in the same manner as prescribed in (3) above, except that the miniature targets will be removed and replaced with new targets after marking.

(b) When 1,000-inch range has no target pit, the following provisions will govern:

1. If the targets are covered by a curtain which can be opened to expose the face of the target and closed again to conceal it, or if the targets operate on a pivot, the rapid fire will be conducted as closely as practicable in conformity with the method set forth above for 1,000-inch range with target pit.
2. If the targets are exposed all the time, rapid fire from standing to prone, kneeling, and sitting will be conducted by the officer in charge, who commands: 1. LIE DOWN (KNEEL OR SIT DOWN), 2. COMMENCE FIRING, 3. CEASE FIRING. Time is taken from the first command.
3. If the targets are exposed all the time, rapid fire preceded by a run will be conducted by the officer in charge who commands: 1. PREPARE TO RUSH, 2. UP, 3. CEASE FIRING. Time is taken from the command UP.

4. After the command UNLOAD and all unfired cartridges are removed from the rifle and the bolts are open, the officer in charge will direct the target detail to mark, remove, and replace the targets.

*g. Use of telephones.*—(1) Telephones will be used for official communication only.

(2) No one will ask over the telephone for information as to the name or organization of any person firing on any particular target, and no information of this nature will be transmitted.

(3) The following expressions will be used over the telephone in the cases enumerated:

(a) When a shot has been fired and the target has not been withdrawn from the firing position, "Mark No. —."

(b) When a shot has been fired and the target withdrawn from the firing position but not marked, "Disk No. —."

(c) When the target has been withdrawn from the firing position and marked, but the value of the shot has not been understood, "Redisk No. —."

(d) When the firing line is ready for rapid fire, "Ready on the firing line."

(e) When a shot is marked on a target and the person assigned thereto has not fired, "Disregard the last shot on No. —."

*h. Miscellaneous rules governing record practice.*—(1) *Identity of firer to be unknown to personnel in pit.*—Officers and men in the pit should not know who is firing on any particular target, and will not attempt to obtain this information; likewise, other officers and men will not transmit such information to personnel in the pit.

(2) *Coaching prohibited.*—Coaching of any nature, after the firer takes his place on the firing point, is prohibited. No person will render or attempt to render the firer any assistance whatever while he is taking his position or after he has taken his position at the firing point. Each firer must observe the location of his own hits as indicated by the marking disk or spotters.

(3) *Use of instruments.*—(a) The use of field glasses, telescopes, and sight-setting instruments is authorized and encouraged.

(b) The use of instruments or devices for determining the force and direction of the wind is prohibited during record practice.

(4) *Shelter for firer.*—Sheds or shelter for the firer will not be permitted at any range.

(5) *Restrictions as to the rifle.*—Troops will use the rifle with which they are armed. The rifle will be used as issued by the Ordnance Department. The use of additional appliances, such as temporary shades for the sights, spirit levels, and orthoptic eyepieces, is prohibited. The sights may be blackened. Any authorized size of peep sight issued by the Ordnance Department may be used. Small arms and appliances issued by the Ordnance Department for test and report will not be used for determining classification.

(6) *Trigger pull.*—The trigger pull will be at least 3 pounds and before record firing will be tested (with the barrel vertical) by an officer.

(7) *Ammunition.*—The ammunition used will be the service cartridge as issued by the Ordnance Department unless the use of other ammunition is authorized.

(8) *Cleaning.*—Cleaning will be permitted only between scores.

(9) *Use of gun sling.*—The gun sling will be used in connection with one arm only. For the purpose of adjustment for shooting, neither end will be removed from either sling swivel. No knot will be tied in the sling and the sling itself will neither be added to nor modified in any manner. When the loop sling is authorized it may be adjusted (secured) to the arm prior to the start of the exercise.

(10) *Pads and gloves.*—(a) To reduce the shock of recoil, to prevent bruising the elbows, and to prevent irritation of the upper arm by the gun sling, pads of moderate size and thickness may be worn on either shoulder, on both elbows, and on either upper arm. Pads of such size, thickness, or construction as to form artificial support for the rifle are prohibited. Shoulder pads so designed by means of excessive size or thickness, quilting, rolls, ridges, or other devices as to aid materially in retaining the rifle butt in the firing position against the shoulder are prohibited. The use of a hook, small roll, or ridge on the sleeve of the shooting

coat or shirt to keep the sling in place on the arm is prohibited.

(b) A glove may be worn on either hand provided it is not used to form an artificial support for the rifle.

(11) *Loading pieces.*—Pieces will not be loaded except by command or until position for firing has been taken.

(12) *Warming or fouling shots.*—No warming or fouling shots will be allowed.

(13) *Action in case of disabled rifle.*—Should a breakage occur the rifle will be repaired or a different rifle substituted. If a different rifle is substituted the firer will be allowed to zero the substituted rifle and then refire the exercise.

(14) *Shots cutting the edge of bull's-eye or line.*—Any shot cutting the edge of the figure or bull's-eye will be signaled and recorded as a hit in the figure or the bull's-eye. Because the limiting line of each division of the target is the outer edge of the line separating it from the exterior division, a shot touching this line will be signaled and recorded as a hit in the higher division.

(15) *Slow-fire score interrupted.*—If a slow-fire score is interrupted through no fault of the person firing, the unfired shots necessary to complete the score will be fired at the first opportunity thereafter. (See (13) above.)

(16) *Misses.*—In all firing, before any miss is signaled, the target will be withdrawn from the firing position and carefully examined by an officer, if an officer is on duty in the pit. Whenever the target is run up and a miss is signaled, it will be presumed that this examination has been thoroughly made. No challenge of the value signaled will be entertained or resignaling of the shot allowed.

(17) *Accidental discharges.*—All shots fired by the soldier after he has taken his place at the firing point (and it is his turn to fire, the target being ready) will be considered in his score even if his piece was not directed toward the target or is accidentally discharged.

(18) *Firing on wrong target.*—Shots fired upon the wrong target will be entered as a miss upon the score of the man firing, no matter what the value of the hit upon the wrong

target may be. In rapid fire the soldier at fault is credited with only such hits as he may have made on his own target.

(19) *Two shots on same target.*—In slow fire, if two shots strike a target at the same time or nearly the same time, both will be signaled; if one of these shots was fired from the firing point assigned to that target, the hit having the highest of the two values signaled will be entered on the soldier's score and no record made of the other hit.

(20) *Withdrawing target prematurely.*—In slow fire, if the target is withdrawn from the firing position just as the shot is fired, the scorer at that firing point will at once report the fact to the officer in charge of the scoring on that target. That officer will investigate to see if the case is as represented. Being satisfied that such is the case, he will direct that the shot be not considered and that the man fire another shot.

(21) *Misfires in rapid fire.*—In the case of a misfire the soldier will cease firing immediately, the target will not be marked, and the score will be repeated.

(22) *Unfired cartridges in rapid fire.*—Each unfired cartridge will be recorded as a miss. In case the number of hits marked exceeds the number of rounds fired the soldier firing on that target will be credited with the hits of highest value corresponding to the number of rounds fired.

(23) *Disabled rifle in rapid fire.*—If, during the firing of a rapid-fire score, the rifle becomes disabled through no fault of the soldier, the pit officer will be directed to disregard the score, the target will not be marked, and the firer will repeat the score. The breaking of a clip in reloading will not entitle the soldier to another score.

(24) *More than 10 hits in rapid fire.*—When a target has more than 10 hits in rapid fire, the target will not be marked, and the soldier firing on that target will repeat his score; except when all the hits on target D or on target D (rifle) 1,000-inch range have the same value, when the target will be marked and he will be given that value for each shot fired by him.



## SECTION V

## EQUIPMENT; KNOWN-DISTANCE TARGETS AND RANGES; RANGE PRECAUTIONS

■ 40. EQUIPMENT.—*a. Equipment for preparatory marksmanship training.*—(1) *General.*—The use during preparatory marksmanship training of complicated apparatus which cannot be readily improvised from materials at hand is prohibited. The simple apparatus described below is ample for all purposes.

(2) *Equipment for each four men.*

One sighting bar, complete.

One rifle rest.

One small sighting disk.

Two small aiming targets (targets A and D (rifle) 1,000-inch range are suitable).

One 10-inch sighting disk.

One small box, approximately the size of an ammunition box.

One frame covered with blank paper for long-range triangles.

Two sandbags.

One pencil.

Twenty rounds practice dummy ammunition.

Four score books (one per man).

One form showing state of training. (Par. 24 *f.*)

Four feet of twine for tying triggers to trigger guard.

Material for blackening sights.

(3) *Equipment for general use.*

One rapid-fire target with curtain for each three squads.

One each A, B, and D targets on frames for score-book exercises.

Cleaning and preserving materials.

One aiming device for each squad.

(4) *Preparation of equipment.*—(a) *Sighting bar.*

1. Provide a bar of wood about 1 by 2 inches and 4½ feet long. Cut two thin slots 1 inch deep across the edge. Place one slot 5½ inches from the end

and the other 26 inches from the same end of the bar (fig. 25 ②).

2. Make a front sight of thin metal  $\frac{1}{2}$  by 3 inches bent in the shape of an L and tack it to the edge of the bar between the two slots and  $\frac{1}{2}$  inch from the slot nearest the end (fig. 25 ④ (d) and (g)). Have the leg of the L project above the bar  $\frac{1}{2}$  to  $\frac{3}{4}$  of an inch (fig. 25 ③).
3. Make an eyepiece from a piece of tin or zinc 3 by 7 inches (fig. 25 ④ (c), (f), and (h)). Cut along the dotted lines to form a shape shown in figure. Tack this eyepiece to the end of the bar farthest from the slots so that the top of the eyepiece extends 1 inch above the top of the bar (fig. 25 ③). Make a round hole 0.03 inch in diameter in the middle of the eyepiece  $\frac{1}{2}$  inch above the bar.
4. Make a peep rear sight of thin metal or cardboard 3 by 3 inches and cut a round hole  $\frac{3}{4}$  inch in diameter in its center (fig. 25 ④ (b)).
5. Cut an open rear sight of thin metal or cardboard  $1\frac{1}{2}$  by 3 inches with a semicircular notch  $\frac{3}{4}$  inch wide in the middle of one of the long edges (fig. 25 ④ (e)).
6. Cut a piece of thin metal or cardboard 3 by 3 inches, painted white, and have a black bull's-eye  $\frac{1}{2}$  inch in diameter painted or pasted on the center (fig. 25 ④ (a)).
7. Place two pieces of tin 1 inch wide and 3 inches long in each slot. Fold the loose ends away from each other and tack them to the sides of the bar (fig. 25 ③).
8. Blacken the eyepiece, the front sight, the rear sights, and the top of the bar.

(b) *Rifle rest*.—An empty ammunition box or any other well-made box of suitable size, with notches cut in the ends to fit the rifle closely, makes a good rifle rest. The rifle is placed in these notches with the trigger guard close to and outside of one end. The sling is loosened and pulled to one side. The box may be half filled with earth or sand to make it more stationary.

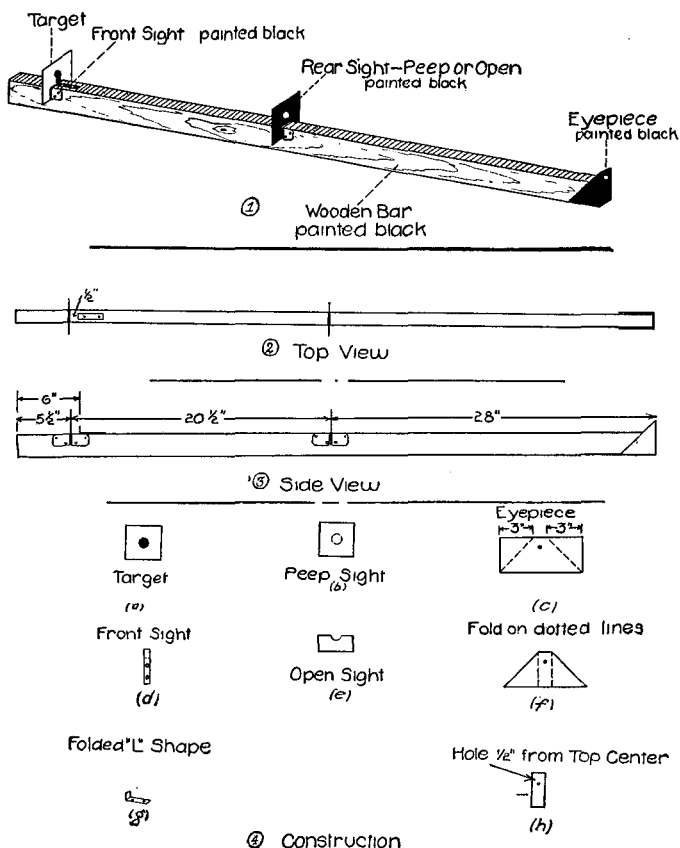

FIGURE 25.—Construction of sighting bar.

Wooden bar—1 by 2 inches by 4 feet 6 inches (approximate).

Eyepiece—Thin metal, 3 by 7 inches; hole, 0.03-inch diameter.

Rear sight—Thin metal or cardboard, 3 by 3 inches; hole in center, 3/4-inch diameter.

Front sight—Thin metal, 1/2 by 3 inches, bent L shape.

Target—Thin metal, or cardboard, 3 by 3 inches, painted white—Black bull's-eye, 3/4-inch diameter in center.

Slits—1 inch deep, may be lined with thin metal strips.

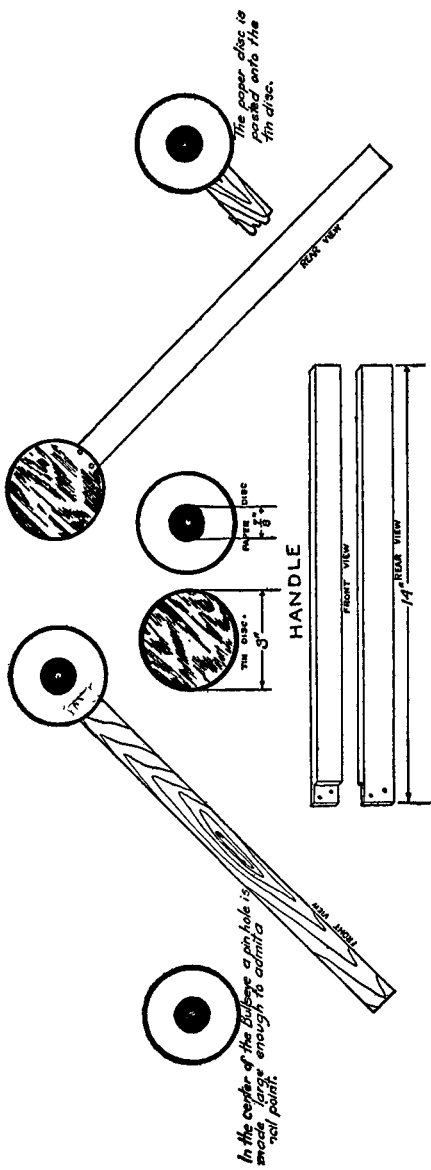

FIGURE 26.—Sighting disk.

(c) *Sighting disks*.—Sighting disks are of three sizes. The disk to be used at a distance of 50 feet is about 3 inches in diameter. The disk is made of tin or cardboard and mounted on a handle as shown in figure 26. The bull's-eye will be mounted on a background of clean white paper. The disks to be used at 200 and 500 yards are, respectively, 10 and 20 inches in diameter. These disks are painted black and mounted on white handles which are 4 or 5 feet long. All bull's-eyes will be black and circular and will have a hole in the center large enough to admit the point of a pencil.

b. *Range equipment*.—(1) *Used at firing point*.

Cleaning racks.

Scorers' tables.

Field glasses (1 per target).

Score cards.

Score board.

Cleaning and preserving materials.

Material for blackening sights.

Score books.

Indelible pencils.

Containers for empty cartridge cases.

Telephones.

(2) *Used in pit*.

Pit record cards.

Indelible pencils.

Telephones.

Ten 3-inch spotters per target.

One 6-inch spotter per target.

One red flag per target.

Marking disks.

Pasters.

Paste.

■ 41. **TARGETS**.—The specifications for marksmanship targets, together with the value of hits in their divisions, are as follows:

a. Target A, the short-range target, used for 200 and 300 yards, is a rectangle 6 feet high, 4 feet wide, black circular bull's-eye, 10 inches in diameter, value of hit, 5; center ring, 26 inches in diameter, value of hit, 4; inner ring, 46 inches

in diameter, value of hit, 3; outer, remainder of target, value of hit, 2.

b. Target B, the midrange target, used for 500 yards, is a square 6 feet on a side, black circular bull's-eye, 20 inches in diameter; center ring, 37 inches in diameter; inner ring, 53 inches in diameter; outer, remainder of target. Value of hits, same as on target A.

c. Target D, the rapid-fire target, is a square 6 feet on a side and has in its middle a black silhouette representing a soldier in the prone position. Value of hits in the figure, 5; in the space immediately outside the figure, 4; in the space immediately outside the 4 space, 3; remainder of the target, 2.

d. Target A (rifle) 1,000-inch range and target D (rifle) 1,000-inch range are a reduction of targets A and D, respectively, from 200 yards to 1,000 inches. Values of the hits on the reduced targets are the same as for targets A and D.

■ 42. KNOWN-DISTANCE TARGET RANGES.—*a. General.*—There are two classes of ranges: class A ranges, which are more or less limited in extent and are equipped for known-distance practice; and class B ranges, which are of extended area and diversified terrain and are used for combat firing. The following subparagraphs refer to class A ranges only.

b. *Rules for selection.*—As the nature and extent of the ground available for target practice and also the general climatic conditions are often widely dissimilar for different military posts, it is not possible to prescribe any particular rules governing the selection of ranges, but only to express certain general conditions to which ranges should be made to conform. In view of the range and penetration of the bullet of the United States rifle, M1903, it will be found necessary in the case of many posts to have target practice conducted at a distance of several miles from the post, a condition which necessitates the establishment of a camp on or near the range. The target practice can then be conducted without the interference of post duties.

c. *Security necessity.*—For posts situated in the thickly settled localities where the extent of the military reservation is limited, the first condition to be fulfilled is that of

security for those living or laboring near or passing by the range. This requirement can be secured for class A ranges by selecting ground where a natural butt is available or by making an artificial butt sufficiently extensive to stop wild shots. See paragraph 7d, AR 750-10, for information concerning danger areas.

*d. Direction of the range.*—If possible, a range should be so located that the firing is toward or slightly to the east of north. Such location gives a good light on the face of the targets during the greater part of the day. However, security and suitable ground are more important than direction.

*e. Best ground for class A range.*—Smooth, level ground or ground with only a very moderate slope is best adapted for a range. The targets should be on the same level with the firer or only slightly above him. Firing downhill should be avoided.

*f. Size of range.*—The size of the range is determined by its plan and by the number of troops that will fire over it at a time. There are two general plans used in range construction; one with a single target pit and firing points for each range, the other with firing points on one continuous line, the target pits for the various ranges being in echelon. The latter type requires more ground and is less suitable for training troops.

*g. 1,000-inch range.*—There are two classes of 1,000-inch ranges—those requiring a danger area behind the back stop and those which do not. Where possible, open 1,000-inch ranges requiring no danger area behind back stop for use in cities will be so sited that sparsely settled territory is behind the back stop and so located that the range will not be a noise nuisance; 1,000-inch ranges requiring a danger area behind back stop must meet the same security requirements as class A ranges.

*h. Principles governing construction.*—(1) *Intervals between targets.*—To reduce to a minimum the amount of labor required in preparing the range, the targets should be no farther apart than is necessary to obviate the probability of a shot being fired on the wrong target. As a general rule, the intervals between targets are equal to the width of the

targets themselves; that is, at short and midrange, 6 feet; at long range, 12 feet. Where the necessity exists for as many targets as possible in a limited space, this interval may be reduced one-half without materially affecting the value of the instruction.

(2) *Protection for markers.*—(a) On all ranges, protection must be provided for the pit details. This is done by excavating a pit for the targets or by constructing a parapet in front of them, or by a combination of these methods.

(b) Where there are several targets in a row, the shelter should be continuous. It must be high enough to protect the markers. The parapet may be of earth, with a timber or concrete revetment, of sufficient thickness to stop bullets, and from 7½ to 8 feet high above the ground or platform on which the markers stand.

(3) *Artificial butts.*—If an artificial butt is constructed as a bullet stop, it should be of earth not less than 30 feet high and with a slope of not less than 45°. It should be extended about 5 yards beyond the outside targets and should be placed as close behind the targets as possible. The slopes should be sodded.

(4) *Hills as butts.*—A natural hill to form an effective butt should have a slope of not less than 45°; if originally more gradual, it should be cut into steps, the face of each step having that slope. As a temporary expedient, the face of the hill may be plowed perpendicularly to the range, but as the bullets soon cut down the furrows this measure must be frequently repeated to prevent the danger of ricochets.

(5) *Numbering of targets.*—Each target should be designated by a number. The numbers for ranges up to 600 yards should be at least 6 feet in height and should be painted black on a white background. Arabic numerals of the size suggested will always be quickly recognized. They should be placed on the butt behind each target or on the parapet in front, and not so far above or below as to prevent the firer seeing the number when aiming at the target.

(6) *Measuring the range.*—The range should be carefully measured and marked with stakes at the firing points in front of each target. These stakes should be about 12 inches above the ground and painted white. They should have in black



figures the number of the corresponding target and its distance. Particular care should be taken that each stake thus placed is parallel to the face of its own target.

(7) *Ranges parallel.*—The different ranges for the same distance should all be parallel, so that similar conditions with respect to wind and light may exist. It is not essential, however, that the ranges employed for long-distance shooting should be parallel to those used for the ordinary company practice.

(8) *Firing mounds.*—If it becomes necessary to raise a firing point on account of low ground, a low mound of earth no higher than absolutely required should be made. The mound should be level, sodded, and not less than 12 feet square. If the entire firing line is raised, the firing mound should be level, sodded, and not less than 12 feet wide on top.

(9) *Pit shed.*—A small house or shed should be built in or near the target pit, in which the marking disks and signal flags and spare parts of the target frames for making immediate repairs should be stored. It should be sufficiently large to afford a shelter for the markers in case of a sudden storm.

(10) *Danger signals.*—A socket for the staff of the danger signals should be placed on the markers' shelter in front of each target and so inclined that the flag will always fall clear of the staff and be readily seen. This flag will always be displayed when the target is in place and not in use. In addition to the danger signals at the targets, a scarlet streamer will be displayed from a prominent point on all ranges and at all times during firing to warn passers-by when firing is in progress. These signals will not be placed in such a position as to serve as streamers for judging wind on the range. They should be placed on the roads or on the crest of the hill, where they can be seen plainly by those passing.

(11) *Range house.*—On large ranges where competitive firing is held, a house containing a storeroom and several office rooms should be erected in some central place off the range but in its immediate vicinity. Such facilities as will enable visitors to witness the firing satisfactorily should also be provided.

(12) *Telephone service.*—Ranges should be equipped with a telephone system connecting the target pit with each firing

point, the range house, and the post. The number of telephones should not be less than one to each 10 targets.

(13) *Electric bells*.—On large ranges the installation for each five targets of an electric bell that can be controlled from a central point in the pit adds materially to the celerity and uniformity of target manipulation for rapid fire.

(14) *Covered ways between pits*.—Where the pits are in echelon, covered ways or tunnels should be provided between the various pits. This construction will allow the pit details to be shifted with safety without interrupting the firing.

(15) *1,000-inch range*.—An open 1,000-inch range requiring no danger area behind backstop must meet the following minimum requirements:

(a) Vertical bulletproof backstop and wing walls (natural or artificial) not less than 30 feet high. Wing walls must cover at least 15° on each flank. In case of artificial wing walls, they should be set at an angle of 15° with the backstop toward the firing points.

(b) Ricochet pit in front of firing points providing at least a 4° slope downward from the normal line of fire from a prone position and extending to within 30 feet of the backstop and wing walls. If a vertical cliff or wall over 40 feet high is available, no ricochet pit need be provided.

■ 43. RANGE PRECAUTIONS.—See AR 750-10.

## SECTION VI

### SMALL-BORE PRACTICE

■ 44. OBJECT.—The object of small-bore practice is to provide a form of marksmanship training with the caliber .22 rifle and ammunition which represents the application of the principles taught in the preparatory exercises. Small-bore practice provides an excellent means of improving the shooting of organizations and sustaining interest in marksmanship throughout the year. The firing of this course enables the company commander to visualize the state of training of his command and to concentrate his efforts on the training of those who are most deficient.

■ 45. VALUE.—The chief value of small-bore practice lies in the fact that it is convenient, interest sustaining, and economical. It does not have the full value of caliber .30 practice because of the absence of recoil, but on account of its convenience and saving in the cost of ammunition organization commanders will find that small-bore practice is a valuable step in marksmanship training.

■ 46. CONTINUOUS SMALL-BORE PRACTICE.—Small-bore practice may be carried on throughout the year, subject to such limitations as may be imposed by the allowance of ammunition. All persons who have never been properly instructed in shooting methods prescribed herein will be given a thorough course of preparatory instruction before being permitted to fire on the small-bore range. All small-bore practice will be properly organized and supervised in accordance with the methods of instruction as prescribed in this manual.

■ 47. COURSES.—*a.* When ammunition allowances, time, and facilities available permit, organizations may fire one of the small-bore courses outlined below.

(1) *Course E.—(a) Instruction practice.*

1. *Short range.*

TABLE I.—*Slow fire (to zero rifle)*

Range (feet)	Time	Shots	Targets	Position	Sling
50	No limit	5	SB-A-2	Prone or prone with sand-bag.	Loop.
50	do	5	SB-A-2	Sitting	Do.
50	do	5	SB-A-2	Kneeling	Do.
50	do	5	SB-A-2	Standing	Hasty.

TABLE II.—*Slow fire*

Range (feet)	Time	Shots	Targets	Position	Sling
50	No limit	10	SB-A-2	Standing	Hasty.
50	do	10	SB-A-3	5 kneeling; 5 sitting	Loop.
50	do	10	SB-B-5	Prone	Do.

TABLE III.—*Rapid fire*

Range (feet)	Time (seconds)	Shots	Targets	Position	Sling
50	60.....	10	SB-D-2.....	Standing to kneeling.....	Loop.
50	75.....	10	SB-D-3.....	Standing to prone.....	Do.

NOTE.—When desired, tables I, II, and III may be fired at 1,000 inches by substituting target A, 1,000-inch, for targets SB-A-2 and A-3; target B, 1,000-inch, for target SB-B-5; and target D, 1,000-inch, for targets SB-D-2 and D-3.

2. *Intermediate range.*TABLE IV.—*Slow fire*

Range (yards)	Time	Shots	Targets	Position	Sling
50.....	No limit.	10	SB-50 yards, A target.	Prone.....	Loop.
50.....	do.....	10	do.....	5 Kneeling; 5 sitting.....	Do.
50.....	do.....	10	SB-50 yards, D target.	Prone to kneeling, rush 25 yards.	Do.

TABLE V.—*Rapid fire*

Range (yards)	Time (seconds)	Shots	Targets	Position	Sling
50.....	75.....	10	SB-50 yards, D target.	Standing to prone.....	Loop.
50.....	75.....	10	do.....	Prone to prone, rush 25 yards.	Do.
50.....	75.....	10	do.....	Prone to kneeling, rush 25 yards.	Do.

NOTES.—The firing included in tables IV and V is optional. If no 50-yard range is available, tables IV and V will be fired at 100 yards on the SB-100 yards, D target. This note applies only to the E course.

When a distance of 25 yards is not available, a shorter distance may be used, reducing the time 2 seconds for each 5 yards.

## 3. Long range.

TABLE VI.—*Slow fire*

Range (yards)	Time	Shots	Targets	Position	Sling
100	No limit.	10	SB-100 yards, A target.	Prone.....	Loop.
100	do.....	10	do.....	5 Kneeling; 5 sitting.....	Do.
100	do.....	10	SB-100 yards, D target.	Prone.....	Do.
200	do.....	10	SB-200 yards, A target.	do.....	Do.

TABLE VII.—*Rapid fire*

Range (yards)	Time (seconds)	Shots	Targets	Position	Sling
100	80.....	10	SB-100 yards, D target.	Standing to prone.....	Loop.
100	100.....	10	do.....	Prone to prone, rush 25 yards.	Do.

(b) *Record practice.*TABLE VIII.—*Slow fire*

Range (yards)	Time	Shots	Targets	Position	Sling
100	No limit.	10	SB-100 yards, A target.	Kneeling.....	Loop.
200	do.....	10	SB-200 yards, A target.	Prone.....	Do.

TABLE IX.—*Rapid fire*

Range (yards)	Time (seconds)	Shots	Targets	Position	Sling
100	80.....	10	SB-100 yards, D target.	Standing to prone.....	Loop.
100	100.....	10	do.....	Prone to prone, rush 25 yards.	Do.

NOTE.—When a distance of 25 yards is not available, a shorter distance may be used, reducing the time 2 seconds for each 5 yards.

(2) *Course F.—(a) Instruction practice.*

1. *Short range.*—Fire tables I, II, III, IV, and V of course E.

2. *Long range.*

TABLE X.—*Slow fire*

Range (yards)	Time	Shots	Targets	Position	Sling
100	No limit.	10	SB-100 yards, A target.	Prone.....	Loop.
100	...do.....	10	SB-100 yards, D target.	...do.....	Do.

TABLE XI.—*Rapid fire*

Range (yards)	Time (seconds)	Shots	Targets	Position	Sling
100	80.....	10	SB-100 yards, D target.	Standing to prone.....	Loop.
100	100.....	10	...do.....	Prone to prone, rush 25 yards.	Do.

(b) *Record practice.*TABLE XII.—*Slow fire*

Range (yards)	Time	Shots	Targets	Position	Sling
50	No limit.	10	SB-50 yards, A target.	Kneeling.....	Loop.
100	...do.....	10	SB-100 yards, A target.	Prone.....	Do.

TABLE XIII.—*Rapid fire*

Range (yards)	Time (seconds)	Shots	Targets	Position	Sling
50	75.....	10	SB-50 yards, D target.	Prone to kneeling, rush 25 yards.	Loop.
100	100.....	10	SB-100 yards, D target.	Prone to prone, rush 25 yards.	Do.

NOTE.—When a distance of 25 yards is not available, a shorter distance may be used, reducing the time 2 seconds for each 5 yards.

(3) *Course G.—(a) Instruction practice.**Short range.—Fire tables I, II, and III of course E.*TABLE XIV.—*Rapid fire*

Range (feet)	Time (seconds)	Shots	Targets	Position	Sling
50	75.....	10	SB-D-3.....	Prone to kneeling, rush 25 yards.	Loop.
50	75.....	10	.....do.....	Prone to prone, rush 25 yards.	Do.

(b) *Record practice.*TABLE XV.—*Slow fire*

Range (feet)	Time	Shots	Targets	Position	Sling
50	No limit.	10	SB-A-3.....	Kneeling.....	Loop.
50	.....do.....	10	SB-B-5.....	Prone.....	Do.

TABLE XVI.—*Rapid fire*

Range (feet)	Time (seconds)	Shots	Targets	Position	Sling
50	75.....	10	SB-D-3.....	Prone to kneeling, rush 25 yards.	Loop.
50	75.....	10	.....do.....	Prone to prone, rush 25 yards.	Do.

NOTE.—When a distance of 25 yards is not available, a shorter distance may be used, reducing the time 2 seconds for each 5 yards.

b. The amount of ammunition for each course and the qualification scores are as follows:

Course	Ammunition	Possible score	Expert	Sharpshooter	Marksman	Unqualified
E.....	230	200	180	160	130	Less than 130.
F.....	210	200	180	160	130	Less than 130.
G.....	130	200	180	160	130	Less than 130.

## CHAPTER 3

### MARKSMANSHIP—MOVING GROUND TARGETS

	Paragraphs
SECTION I. General.....	48-49
II. Moving vehicles .....	50-52
III. Moving personnel.....	53-54
IV. Moving targets, ranges, and safety precautions .....	55-56

#### SECTION I

#### GENERAL

■ 48. SCOPE OF TRAINING.—Rifle units will be trained to fire at moving targets, such as tanks, armored vehicles, trucks, and personnel at appropriate ranges. Rifle fire may be employed to repulse or harass unarmored vehicles and motorized troops. Rifle units will be trained to meet a tank attack by taking cover, standing their ground, and delivering the maximum possible aimed fire with armor-piercing or ball ammunition at the enemy tanks and hostile foot troops which may accompany them. To this end they must be trained in the technique of such fire.

■ 49. BASIC PRINCIPLES.—The principles of shooting as presented in this chapter apply to firing at moving targets. In applying these principles the firer must adjust his aim and trigger squeeze to conform to the movement of the target.

*a. Effective range.*—While under ideal conditions moving targets may be engaged at ranges above 600 yards, effective results beyond that range are considered to be exceptional. For this reason training in the technique of fire is normally limited to ranges of 600 yards or less.

*b. Sights to be used.*—Moving targets are seldom exposed for long periods and can be expected to move at maximum speed during periods of exposure. Accurate correction of sight setting is often impracticable, therefore instruction in technique should favor the use of the battle sight. Corrections for range are made by adjustment of the aiming



point on the target. The peep sight is habitually set at 300 yards and is immediately available for use against moving targets at close range when appropriate.

*c. Leads.*—Targets which cross the line of sight at any angle are classified as crossing targets. In firing at such targets the firer must aim ahead of the target so that the paths of the target and bullet will meet. The distance ahead of the target is called the *lead*. Targets which approach directly toward the firer or recede directly from the firer will for all practical purposes require no lead.

## SECTION II

### MOVING VEHICLES

■ 50. DETERMINATION AND APPLICATION OF LEADS.—*a.* The lead necessary to hit a moving vehicle is dependent upon the speed of the target, the range to the target, and the direction of movement with respect to the line of sight. Moving at 10 miles an hour a vehicle moves approximately its own length of 5 yards in 1 second. A rifle bullet moves 400 yards in about  $\frac{1}{2}$  second and 600 yards in about 1 second. Therefore to hit a vehicle moving at 10 miles an hour at ranges of 400 yards and 600 yards, the leads should be  $2\frac{1}{2}$  yards and 5 yards, respectively. At a speed of 20 miles an hour the leads should be 5 yards and 10 yards, respectively.

*b.* Leads are applied by using the length of the target as it appears to the firer as the unit of measure. This eliminates the necessity for corrections due to the angle at which the target crosses the line of sight, because the more acute the angle the smaller the target appears and the less lateral speed it attains.

*c.* The following lead table is furnished as a guide:

TARGET LENGTHS

Miles per hour	400 yards or less	400-600 yards
10	$\frac{1}{2}$	1
20	1	2

■ 51. **TECHNIQUE OF FIRE.**—The following technique is suggested for firing at rapidly moving targets, using battle sight:

*a. Approaching or receding targets.*—The firer holds his aim on the center of such target and squeezes off his shot.

*b. Crossing targets.*—(1) *At ranges less than 600 yards.*—The firer alines his sights on the bottom of the target at its rearmost point, and swings straight across it to the estimated lead. The rifle is kept swinging and the shot squeezed off as the proper lead is reached.

(2) *At ranges of 600 or more yards.*—The firer proceeds as in (1) above except that he swings his point of aim across the top of the target.

*c.* Fire is executed as rapidly as proper aiming will permit.

■ 52. **PLACE IN TRAINING.**—The technique of firing at moving vehicles with service ammunition properly follows individual training in known-distance firing. When time and ammunition allowances permit, 1,000-inch and caliber .22 firing may be added as preliminary instruction.

### SECTION III

#### MOVING PERSONNEL

■ 53. **TECHNIQUE.**—*a. Sight to be used.*—Under field conditions, moving personnel presents a fleeting target, and one more difficult to hit than a moving vehicle. This fact makes the use of the peep sight desirable for greater accuracy. However, the use of battle sight may be necessary when targets appear suddenly, allowing no time for sight adjustment. It is therefore desirable that the individual rifleman be trained in the employment of both sights in this type of firing.

*b. Method of aiming.*—An elaborate system of calculating leads is neither necessary nor desirable. The following general rule forms the basis for estimating the proper leads. When firing at a man walking across or at right angles to the line of fire, the points of aiming at the various ranges are as follows:

(1) At 100 yards, aim at forward half of body.

(2) At 200 yards, aim at forward edge of body.

(3) At 300 yards, lead him one-half the width of his body.

(4) At 400 yards, lead him the width of his body.

Proficiency in this type of firing depends largely upon the amount of time devoted to it by the individual in the practice of aiming, squeezing the trigger, and leading with appropriate speed.

■ 54. PLACE IN TRAINING.—As in the case of practice in firing at moving vehicles, instruction in this type of firing should follow instruction in known-distance firing and should immediately precede the training of the squad in technique of fire (musketry) when practicable.

#### SECTION IV

### MOVING TARGETS, RANGES, AND SAFETY PRECAUTIONS

■ 55. GENERAL.—*a.* Instruction in firing at moving targets is an important phase of training in the technique of fire. Units should be given this instruction whenever time and facilities permit.

*b. Moving vehicles.*—A suggested target for representing a moving vehicle is shown in figure 27.

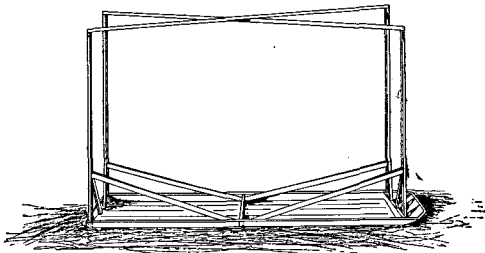
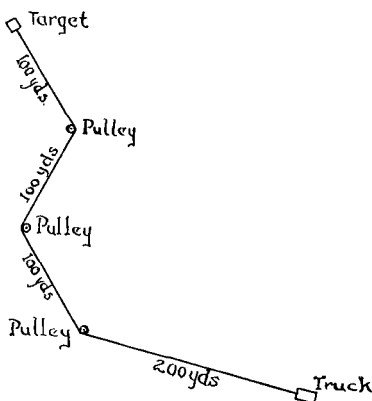

FIGURE 27.—Skeleton sled target.

This target has the advantage of a low center of gravity, which prevents upsetting on rough ground and in making changes of direction. It is simple to construct and suitable. The method of operating is shown in figure 28. Other types of targets may be improvised.

c. *Moving personnel.*—Any class A range is suitable for this type of instruction. E targets on sticks carried by men working in the pits are sufficient.



• GUN

FIGURE 28.—Set-up for towing a target.

■ 56. SAFETY PRECAUTIONS.—a. The safety precautions listed herein will be rigidly adhered to.

b. Firing at moving targets will not be permitted on any range until the safety angles have been carefully checked and markers have been placed so as to define clearly the right and left limits of fire.

c. Personnel of the towing trucks will operate at such distance from the line of fire as to afford protection not only from direct hits but from ricochets.

d. Trucks replacing targets on the course, or personnel effecting repairs on the course, will be equipped with red flags.

e. Target personnel will not leave the designated safety area until the signal or command to do so has been given.

f. The officer in charge of firing will be responsible that—

(1) Rifles are not pointed in such a direction that the target detail will be endangered.

(2) Rifles are not pointed in such a direction that the fire will extend outside the prescribed limits outlined on the range.

(3) Firing ceases immediately upon the command **CEASE FIRING**.

(4) Rifles are clear and bolts open before permitting the target detail to move on the range.

(5) The range is clear before giving the command **LOAD**.

(6) The general safety precautions listed in AR 750-10 are complied with.

## CHAPTER 4

### MARKSMANSHIP—AIR TARGETS

	Paragraphs
SECTION I. Nature of air targets for rifle.....	57-58
II. Technique of fire.....	59-63
III. Antiaircraft marksmanship.....	64-68
IV. Miniature range practice.....	69-72
V. Towed-target firing.....	73-77
VI. Ranges, targets, and equipment.....	78-83

#### SECTION I

##### NATURE OF AIR TARGETS FOR RIFLE

■ 57. AIR TARGETS SUITABLE FOR RIFLE FIRE.—Combat arms take the necessary measures for their own immediate protection against low-flying hostile aircraft. Therefore all infantry troops must be fully trained and imbued with the determination to protect themselves against hostile aerial attacks without reliance upon other arms. All low-flying hostile airplanes are suitable targets for rifle fire. These targets consist of aircraft on reconnoitering missions, maneuvering to take photographs, spotting for artillery, diving or hedge-hopping to attack ground troops, and installations.

■ 58. CLASSIFICATION OF AIR TARGETS.—From the point of view of the rifleman air targets may be classified as—

*a. Overhead*—those which pass over or nearly over the rifleman; or *nonoverhead*—those which do not pass over or nearly over the rifleman. Either of these types may be flying at a constant altitude or may be decreasing or gaining in altitude.

*b. Direct diving*—those which dive directly toward a rifleman; or *direct climbing*—those which climb directly away from a rifleman.

## SECTION II

## TECHNIQUE OF FIRE

■ 59. GENERAL.—Airplanes which are suitable targets for rifle fire present very fleeting targets. They must be engaged promptly by all available weapons. Riflemen must be taught a simple method of firing on hostile low-flying airplanes. This section on the technique of fire deals entirely with actual fire on hostile airplanes. Details of antiaircraft marksmanship training are contained in sections III, IV, and V of this chapter.

■ 60. LEADS.—*a. General.*—In order to hit a target, such as an airplane in flight, it is necessary to aim an appropriate distance ahead of it and on its projected path of flight so that the target and the bullet will meet. This distance ahead of the airplane is called "lead." A lead must be applied in all firing except when the target is at extremely close range (100 feet), when it is diving directly at the firer, or flying directly from him.

*b. Determination of leads.*—(1) The lead necessary to engage any target depends upon—

- (a) The speed of the target.
- (b) The range to the target.
- (c) The time of flight of the bullet.

(d) The direction of flight of the target with respect to the line of fire.

(2) When a target appears, it is impossible for riflemen or leaders of rifle units to consider all of the factors contained in (1) above and compute accurately the lead required for firing. Therefore leads are computed and placed in lead tables for use of leaders in training their units. (See par. 153 c.)

*c. Application of leads.*—Although leads are originally computed in feet or yards, they are given in lead tables as target lengths. It is very difficult for a rifleman to estimate, with any degree of accuracy, a lead such as 40 or 50 yards at ranges from 600 to 100 yards. Therefore, the length of the target as it appears to the firer is used as the unit of measure for applying leads. The rifleman is trained to apply the length of

the target, as it appears to him, along the projected path of the target to determine the aiming point for each shot. The number of times he applies this unit of measure will be announced in a fire order or as explained in paragraph 62.

■ 61. TARGET DESIGNATION.—*a.* Aerial target designation may be given as routine training in training areas long before the area of probable hostile air attack is reached. Aerial targets for a single unit will be clearly visible and few in number.

*b.* Attacking aviation will usually fly in a V-shaped formation of three airplanes each or will operate individually. Should all the fire of a rifle unit be directed at one airplane, the normal dispersion will result in effective interdiction of the remaining airplanes of the formation. Therefore the normal method of target designation is to assign each of the three airplanes to an element of the rifle platoon during the training period. For example, the first squad may be assigned the leading airplane, the second squad the right airplane, and the third squad the left airplane. In case less than three airplanes attack, the units not having a target assigned fire on the leading airplane. The assignment is not changed except under unusual circumstances.

*c.* The normal assignment of a target extends from its initial appearance until it passes beyond range. The unit leader, seeing a succession of groups of hostile airplanes will cause his unit to cease fire at one group in time to bring fire on the following groups as they approach within effective range.

■ 62. FIRE DISTRIBUTION.—*a.* The fire of rifle units must be distributed along the path of flight of the target as long as the target is within effective range. This is done as follows:

(1) For all targets except direct diving or direct climbing *aim and fire each shot with four target-length leads.*

(2) For all direct diving or direct climbing targets *aim and fire each shot at the target.*

*b.* This method of fire distribution is based upon the fact that as the target is approaching or receding the range and the leads are constantly changing. The lead used is the average of all leads necessary to engage a target between the extreme effective range of 600 yards and a minimum range of 0 yards.



c. The target considered in determining the lead of four target lengths is a 30-foot airplane. In using this method for towed-target firing the lead will have to be changed in accordance with the length of the sleeve target.

d. It is impracticable for men to estimate airplane speeds with any degree of accuracy; therefore the speed of present day attack airplanes, which is approximately 200 miles per hour, is used. For speeds considerably greater or less than 200 miles per hour the lead should be changed proportionately. The speed of the target may be slightly more or less than 200 miles an hour; however, the lead if computed on approximate data and the lead estimates of all riflemen are approximations at best. Experience has shown that this method of distribution gives results equal to or better than more accurate and more complicated methods.

■ 63. DELIVERY OF FIRE.—*a. Range.*—(1) The maximum effective range of rifle fire at air targets is approximately 600 yards. However, riflemen should take the firing position as soon as possible after receiving the warning of the approach of hostile airplanes and track the target until it comes within range.

(2) Training in estimating ranges of air targets is conducted by having individuals observe airplanes flying at known ranges. The individual bases his estimate on the appearance of the airplane at key ranges. The following ranges and parts of airplane visible at those ranges are based on an O-46 airplane.

	Range (yards)
General outline.....	1,000
Wheels, rudder, wing struts, tail skid.....	700
Antenna and small projections from fuselage....	500
Symbols, numbers, letters.....	200

*b. Rate.*—The rate of fire at aerial targets is about the same as the rapid-fire rate at ground targets. Everything must be done to increase the rate of fire without affecting its accuracy. Repeated tests have proved that rifle fire delivered faster than is consistent with proper aim and trigger squeeze results in waste of ammunition. Each shot must be aimed and squeezed. A well-trained rifleman can fire one shot in 3 or 4 seconds. A

faster rate is possible if the rifleman does not aim and squeeze the trigger. This should not be permitted.

*c. Sight used.*—Battle sight is used in all firing at aerial targets. It is impossible to use the peep sight and see the target, while aiming at the estimated lead.

*d. Accuracy.*—Firing in time of peace indicates that the antiaircraft fire of trained riflemen is effective and should cause substantial losses to hostile air units.

*e. Effect of caliber .30 fire on the airplane.*—(1) There are various degrees of possible damage to an airplane from rifle fire. Hits upon the cylinder walls and other important working parts are likely to stop an engine immediately. A hit through the metal propeller is also serious, since it throws the engine out of balance. Unless the bombs carried by the airplane are bulletproof, hits by armor-piercing small-arms bullets will detonate them. Of course the pilot is especially vulnerable.

(2) There are also many lesser ways in which infantry fire can damage an airplane. Holes through the crank case may cause the oil to drain out and the engine to "freeze" before the airplane returns to friendly territory. Hits of any kind, in fact, require varying degrees of repair, if they do not cause the destruction of the airplane.

### SECTION III

#### ANTI-AIRCRAFT MARKSMANSHIP

■ 64. GENERAL.—*a. Object of instruction.*—The object of antiaircraft marksmanship instruction is to train the rifleman in the technique of firing at rapidly moving aerial targets.

*b. Basis of instruction.*—(1) Prior to instruction in antiaircraft marksmanship the soldier should have completed a course of training in rifle marksmanship and thereby acquired the fundamentals of good shooting. To become a good antiaircraft marksman he must be able to apply the fundamentals of target practice to firing at rapidly moving targets and to perform the following operations with accuracy and precision:

(a) Apply the length of the target as a unit of measure in measuring the required lead.

(b) Aline the sights of the rifle on the required lead rapidly.

(c) Swing the rifle with a smooth, uniform motion so as to maintain the aim on the required lead while getting off the shot.

(d) Properly apply the trigger squeeze so as to fire in a minimum of time and without disturbing the aim.

(2) The correct performance of these four operations combined into one continuous smooth motion when firing in any direction at rapidly moving aerial targets is the basis for the course of training outlined herein.

*c. Sequence of training.*—Antiaircraft rifle marksmanship is divided into preparatory exercises, miniature range practice, and towed-target firing.

*d. Personnel to receive training.*—All personnel of units whose primary weapon is the rifle should receive antiaircraft marksmanship training consistent with the time available and ammunition allowances.

■ 65. PREPARATORY EXERCISES.—*a. General.*—(1) *Description.*—The preparatory exercises are designed to teach the soldier the correct method of performing each of the fundamentals of antiaircraft rifle marksmanship and to drill him therein until the correct procedure becomes a fixed habit. In addition to a brief explanation of the technique of antiaircraft rifle fire the preparatory exercises consist of the following three distinct steps which should be completed on each of the targets described hereafter prior to firing on those targets:

(a) Position exercise.

(b) Aiming and leading exercise.

(c) Trigger-squeeze exercise.

(2) *Methods.*—A conference by the instructor should precede each exercise. This conference should include an explanation of the necessity of the exercise, and demonstrations by the instructor and a qualified squad. In order to awaken interest and to stimulate the soldier's enthusiasm the preliminary instruction should be individual and

thorough. Each man should understand and be able to explain each point.

(3) *Coaching*.—During all preparatory exercises and miniature range firing when a man is in a firing position, he should have a coach whose duty it is to watch him and to point out errors. For this purpose the soldiers should be grouped in pairs and take turns in acting as coach and pupil. Unit leaders are the instructors and should supervise and prompt the coaches.

*b. Organization*.—With the targets and target ranges described hereinafter (pars. 78 to 83, incl.), a group of 32 men per target is the most economical training unit. For the preparatory exercises this will permit 16 men to per-



FIGURE 29.—Organization for training.

form the exercises on each type of target while the remaining 16 men act as coaches. (See fig. 29.) Each group should complete all preparatory training and instruction firing on its assigned target. Groups should then change places. The preparatory training and instruction firing should then be undertaken on the new type of target. This procedure should be followed until each man of each group has completed his instruction on each of the four types of targets.

■ 66. FIRST STEP—POSITION EXERCISES.—*a. General*.—The positions used in antiaircraft firing are those which can be assumed rapidly, afford the maximum flexibility to the body for the manipulation of the rifle, and do not require undue

exposure of the firer. These positions will usually be either kneeling or standing. The kneeling position best meets the requirements listed above, as it is less vulnerable than the standing position.

*b. Firing positions.*—(1) Antiaircraft firing positions differ from those used in ground target firing in that—

(a) The sling is not used.

(b) The arms are not supported but move freely in any direction with the body.

(c) The hands grasp the piece firmly, the left hand near the lower band.

(d) The butt of the rifle is pressed firmly against the shoulder with the right hand and the cheek is pressed against the stock.

(e) In the kneeling position the buttock does not rest on the heel, and the left foot is well advanced to the left front. The weight is slightly forward. (Fig. 30.)

(2) The positions must be such that the rifle, the body from the waist up, the arms, and the head are as one fixed unit.

(3) When leading a target the rifle must be swung with a smooth, uniform motion. This is accomplished by pivoting the body at the waist. There should be no independent movement of the arms, the shoulders, the head, or the rifle.

(4) The instructor explains and demonstrates the position, and points out that if the rifle is pulled or pushed in the desired direction by means of the left hand and arm, the rifle will move with a jerky motion, thereby increasing the possibility of jerking the trigger, or the front sight may be pulled or pushed out of alinement with the rear sight and the eye.

(5) Position exercises should be conducted so that the soldier will become proficient in rapidly assuming positions for firing at hostile aircraft moving in any direction.

■ 67. SECOND STEP—AIMING AND LEADING EXERCISES.—*a. General.*—(1) *Purpose.*—The purpose of the aiming and leading exercises is to teach the correct method of aiming and to develop skill in swinging the rifle with a smooth, uniform motion so as to maintain the aim on aerial targets.

(2) *Method.*—(a) In the case of the groups assigned to the nonoverhead targets, the pupils in the standing ready position



①



②

FIGURE 30.—Rifleman in antiaircraft kneeling position.

are placed in one line at about  $1\frac{1}{2}$  yards' interval, 500 inches from and facing the assigned target. The coaches take positions that enable them to observe the pupils. The commands for the exercise are: 1. AIMING AND LEADING EXERCISE, 2. ONE

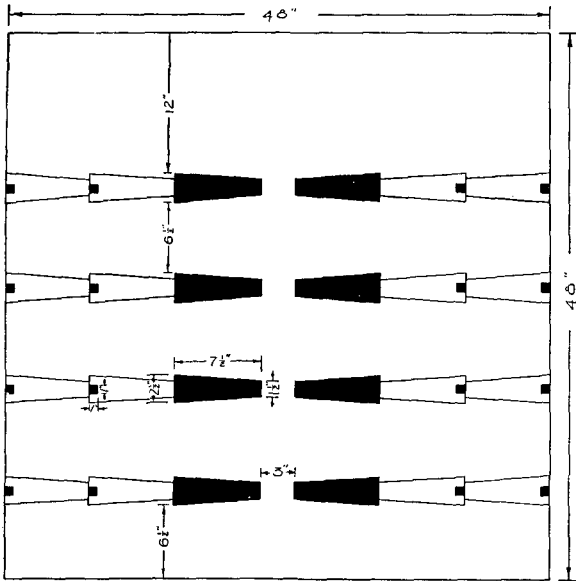

① Nonoverhead.

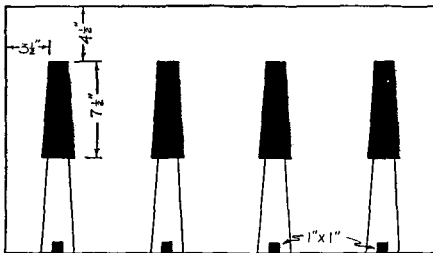

② Overhead.

FIGURE 31.—Aiming and leading targets.

(TWO OR THREE) TARGET-LENGTH LEADS, 3. TARGETS. At the command TARGETS, the targets are operated at a speed of from 15 to 20 feet per second; the pupils assume the kneeling firing position rapidly, aline the sights on the spotter indicating the proper lead, and take up the slack in the trigger; then swing the rifle with a smooth, uniform motion by pivoting the body at the waist, and maintain the aim on the proper lead during the travel of the target. The operation is repeated as the target is moved in the opposite direction. The exercise is continued until the target has been moved five times in each direction. The coach and pupil then change places and the exercise is continued until all men have acquired some skill in aiming and leading with one, two, and three target-length leads, both from right to left and left to right.

(b) In the case of the group assigned to the overhead target, the line is formed perpendicular to and facing the line of flight of the target. The procedure is the same except that one or two target-length leads only are used. (See fig. 31 for targets used.)

(3) *Importance of correct position.*—The importance of correct position and of swinging the rifle with a smooth, uniform motion by pivoting the body at the waist should be constantly emphasized.

*b. Duties of the coach.*—In the aiming and leading exercise the coach insures that the—

- (1) Proper position is taken.
- (2) Slack is taken up promptly and firmly.
- (3) Rifle is swung with a smooth motion.
- (4) Rifle is swung by pivoting the body at the waist.
- (5) Arms, shoulders, rifle, and head move as a unit with the rifle.

■ 68. THIRD STEP—TRIGGER-SQUEEZE EXERCISES.—*a. Importance.*—(1) Correct trigger squeeze is the most important operation to be performed in firing the rifle. The rifleman should be trained to squeeze the trigger exactly as when firing rapid fire at stationary targets except that the rifle is kept in motion during the trigger squeeze, the firing of the shot, and momentarily after the firing of the shot.

(2) In firing at a rapidly moving target the untrained man has a tendency to permit the rifle to come to rest momen-



tarily while applying the final squeeze. This results in the shot passing behind the target. Another fault of the untrained man is that of pulling the trigger quickly the instant the aim is on the required lead. This causes the firer to flinch because he knows when the cartridge will be discharged.

(3) Unless men are trained to apply pressure on the trigger so that they cannot know the exact instant the cartridge will be discharged, all other training will have been a waste of time.

(4) Due to the short period of time during which the usual aerial target will be within effective range, fire should be opened as soon as possible and delivered at as rapid a rate as possible consistent with accuracy. The trigger should therefore be squeezed aggressively and decisively. Once started, the squeeze should be continued until the cartridge is fired.

(5) Skill in squeezing the trigger properly when firing at rapidly moving targets is difficult to acquire. Although men will have had training in trigger squeeze during their course in stationary target marksmanship, firing at rapidly moving targets introduces certain additional elements which must be overcome before skill is acquired. The greater part of the time allotted to preparatory exercises should therefore be devoted to trigger-squeeze exercises.

*b. Object.*—The object of the trigger-squeeze exercises is to train the rifleman to apply pressure on the trigger while keeping the rifle in motion, to develop a decisive trigger squeeze so that fire can be opened in a minimum of time without loss of accuracy, and to train him to follow through with the shot.

*c. Method.*—(1) Trigger-squeeze exercises are conducted in a manner similar to the aiming and leading exercises. The targets used are also the same except that the spotters indicating the lead are removed. (See fig. 32.) If the spotters indicating the lead are left on the target they will cause an increased tendency of the pupil to pull the trigger quickly the instant the aim is on the spotter, thereby defeating the purpose of the exercises.

(2) The pupils in the standing ready position are placed in one line at about 1½ yards' interval, 500 inches from and facing the assigned nonoverhead target. The coaches take position so they can observe the pupil. The commands for the

exercise are: 1. SIMULATE LOAD, 2. TRIGGER-SQUEEZE EXERCISE, 3. ONE (TWO, OR THREE) TARGET-LENGTH LEADS, 4. TARGETS. At the command TARGETS, the targets are operated at the proper speed; the pupils rapidly assume the kneeling firing position,

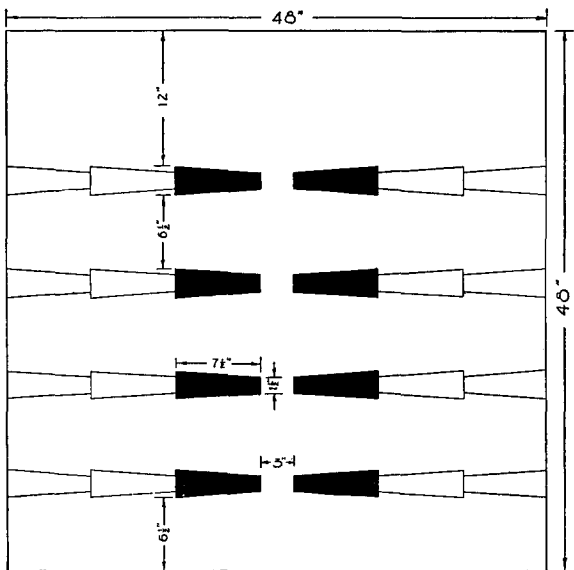

① Nonoverhead.

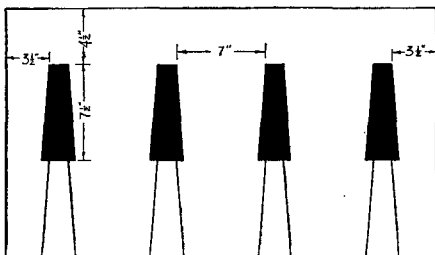

② Overhead.

FIGURE 32.—Instruction targets.

take up the slack in the trigger, mentally apply the target length as a unit of measure in measuring the lead announced in the order; direct the aim on that point and, by swinging the rifle in the manner taught and practiced in the aiming and leading exercise, maintain the aim at the proper lead, at the same time applying a constantly increasing pressure on the trigger until the striker is released. The aim and pressure on the trigger are maintained during the entire length of travel of the target regardless of the time of release of the striker. The importance of following through with the shot cannot be too strongly emphasized. It is only by this means that men will develop the habit of keeping their rifle in motion during the entire process of firing. All of these steps are performed as one continuous operation. The exercise consists of squeezing the trigger each time the target moves across the front. The exercise consists of five passages of the target in each direction. The coach and pupil then change places, and the work is continued until all men have become proficient in squeezing the trigger correctly using various target-length leads.

(3) The procedure for overhead trigger-squeeze exercise is the same except that the line is formed perpendicular to and facing the flight of the target and one or two target-length leads only are used.

*d. Duties of the coach.*—In the trigger-squeeze exercise the coach sees that the—

- (1) Proper position is taken.
- (2) Slack is taken up promptly and firmly.
- (3) Rifle is swung with a smooth, uniform motion.
- (4) Rifle is swung by pivoting the body at the waist.
- (5) Arms, shoulders, rifle, and head move as a unit as the rifle is swung.
- (6) Pressure on the trigger is applied promptly, decisively, and continuously.
- (7) Eye is kept open and does not blink at the instant the striker falls.
- (8) Muzzle does not jerk coincident with the release of the striker.
- (9) Pupil continues the aim and trigger pressure during the entire length of travel of the target.

## SECTION IV

## MINIATURE RANGE PRACTICE

■ 69. GENERAL.—*a.* Miniature range practice is divided into two parts—instruction firing and group firing. There is no record firing.

*b.* All firing is on moving targets on the 500-inch range. A suggested arrangement of the range is given in paragraph 79. Provision is made for simultaneous firing by separate groups on the horizontal, the diving, the climbing, and the overhead targets.

*c.* The course should first be fired with the caliber .22 rifle after which, if ammunition and danger area will permit, the caliber .30 rifle may be used.

*d.* All rifles should be zeroed before range practice starts.

■ 70. SAFETY PRECAUTIONS.—*a.* Bolts of rifles should be open at all times except when on the firing line, firing, or simulating firing.

*b.* Rifles should be loaded only at the command of the officer in charge of the firing on each target.

*c.* At the completion of the firing of a score all rifles should be unloaded and bolts opened.

*d.* If firers go forward to inspect their targets, rifles should be left on the firing line.

*e.* No one will be permitted in advance of the firing line except by permission of the officer in charge of that particular target. He will not give such permission until he has assured himself that all rifles have been unloaded and the bolts are open.

*f.* Target operators will remain behind the protective wall except when ordered to leave by the officer in charge of the target which they are operating.

*g.* Before permitting any firing, the officer in charge of each target will instruct all members of a group that while using the caliber .22 rifle the bolt will not be forced home if difficulty in feeding is experienced. Attempting to force the bolt home may result in igniting a cartridge before the cartridge is chambered.

■ 71. INSTRUCTION FIRING.—*a. General.*—(1) The purpose of instruction firing is to provide a means of applying the principles taught in the preparatory exercises to actual firing.

(2) During instruction firing the soldier works under the supervision of a coach.

(3) As a group completes the preparatory training on a target, instruction firing should be taken up on that target and completed before the group moves to another target.

(4) Instruction firing consists of that indicated in table I.

*b. Procedure.*—(1) As the instruction firing on each type of target follows immediately after the preparatory exercises on that target, the organization of the training unit for firing should be the same as that given in paragraph 65 *b*.

(2) The front rank of each group is formed on the firing line *in the kneeling firing position*. The rear rank acts as coaches.

(3) One-half of the front rank of the group fire while the remaining front rank men simulate firing.

(4) Silhouettes are assigned to each individual firer. For example, the four silhouettes on the right of the targets are assigned the first four men on the right of the line; the four silhouettes on the left of the targets are assigned the next four men. Silhouettes for the men simulating firing are assigned in the same manner, that is, the right four are assigned silhouettes on the right of the target and the left four are assigned silhouettes on the left of the target.

(5) The officer in charge of the target commands: 1. LOAD, 2. ONE (TWO-THREE) TARGET-LENGTH LEADS, 3. TARGETS. At the command TARGETS, the targets are operated at the proper speed. Men assigned silhouettes on the right half of the nonoverhead targets mentally apply the target length as a unit of measure in measuring the lead announced. They direct their aim on that point and while maintaining the aim squeeze the trigger until the shot is fired. They continue to maintain the aim during the entire length of travel of the target regardless of the time the shot was fired. They fire one shot each time the target crosses from their left to right. The men assigned silhouettes on the left half of the same targets aim and fire one shot in the

same manner as explained above each time the target crosses from their right to left.

(6) Men assigned silhouettes on the overhead target fire one round each time the target is run in the approaching direction in exactly the same manner as explained above.

(7) Five rounds constitute a score. After each string of five rounds, targets are scored and shot holes penciled.

(8) One point is awarded for each hit in the silhouette when using one target-length lead or in the proper scoring space when using more than one target-length lead.

(9) Half-groups alternate firing and simulating firing.

(10) When front rank men have fired two scores, one score as the target moved in each direction, they change places with the men in the rear rank. They coach the rear rank men who become the firers.

(11) This procedure is followed until all men of the group have performed the required firing at that target.

(12) Upon completion of the firing prescribed in table I for any one type of target, the group moves to another type target and continues until all have completed the instruction firing.

(13) Modifications of the foregoing method of firing to meet local conditions are authorized.

TABLE I.—*Instruction firing*

(Range 500 inches)

Target	1 lead, 10 rounds	2 leads, 10 rounds	3 leads, 10 rounds	Total
Horizontal	5 rds. R to L	5 rds. R to L	5 rds. R to L	} 30
	5 rds. L to R	5 rds. L to R	5 rds. L to R	
Climbing	5 rds. R to L	5 rds. R to L	5 rds. R to L	} 30
	5 rds. L to R	5 rds. L to R	5 rds. L to R	
Diving	5 rds. R to L	5 rds. R to L	5 rds. R to L	} 30
	5 rds. L to R	5 rds. L to R	5 rds. L to R	
Overhead	5 rds. approaching	5 rds. approaching	5 rds. approaching	} 20
	5 rds. receding	5 rds. receding	5 rds. receding	

Speed of all targets, 15 to 20 feet per second. Total rounds, 110.

■ 72. GROUP FIRING.—*a. General.*—(1) Group firing is the final phase of antiaircraft marksmanship training on the miniature range.

(2) It provides for competitions and illustrates the effectiveness of the combined fire of a number of riflemen.

(3) Group firing should not be undertaken until the preparatory training and instruction firing have been completed.

*b. Procedure.*—(1) Two silhouettes, one to be fired upon as the target moves from left to right and one to be fired upon as the target moves in the opposite direction, are assigned to each squad or similar group.

(2) Each man of the front rank, then each man in the rear rank, fires five rounds at each silhouette as the target moves in the appropriate direction.

(3) Targets are not scored until completion of the firing of the entire squad or group.

*c. Scoring.*—A value of 1 is given each hit on the silhouette.

## SECTION V

### TOWED-TARGET FIRING

■ 73. GENERAL.—*a.* Towed-target firing is the final phase of rifle antiaircraft marksmanship. It is conducted on the towed-target range described in paragraph 80.

*b.* It consists of firing with caliber .30 ball or tracer ammunition at a sleeve target at various ranges and on varied courses.

*c.* Towed-target courses prescribed herein are guides which may be modified. Safety measures and ammunition requirements restrict the length of the course. Safety measures also prevent the adoption of courses such as those on which the target, moving at a low altitude, is receding from or diving at the firing line.

*d.* Towed-target firing will follow miniature range instruction firing. If, due to lack of facilities, a unit is unable to conduct miniature range firing it may be permitted to conduct towed-target firing providing antiaircraft marksmanship preparatory training has been completed.

■ 74. COURSES TO BE FIRED.—Units authorized to fire will fire one or more of the courses enumerated in table II.

TABLE II.—*Courses to be fired*

Course No.	Type of flight	Altitude of target	Horizontal range of course (yards) <sup>1</sup>	Speed	Remarks
1	Nonoverhead—horizontal (parallel to firing line from left to right).	Minimum consistent with safety.	Minimum 100; maximum depends on width of danger area of range.	Maximum possible.	See fig. 44.
2	Nonoverhead—horizontal (parallel to firing line from right to left).	do	do	do	Do.
3	Overhead (perpendicular to firing line).	do	Minimum 100; maximum 450.	do	See fig. 45.
4	Combined courses 1, 2, and 3.	do	Same as for courses 1, 2, and 3.	do	See fig. 46.

<sup>1</sup> The horizontal distance from the firing point directly under the target.

The maximum slant range for all courses should not exceed 600 yards.

■ 75. SAFETY PRECAUTIONS.—*a.* Towed-target firing will be conducted with due regard for the safety of the pilot of the towing airplane, the personnel engaged in firing, and all spectators.

*b.* All firing must be controlled by suitable signals or commands. COMMENCE FIRING and CEASE FIRING must be given in such a manner as to be understood clearly and promptly by everyone engaged in firing.

*c.* The signals and commands for COMMENCE FIRING and CEASE FIRING will be given at such time as to prevent any bullets from falling outside the danger area.

*d.* For all overhead flights, the signal or command for COMMENCE FIRING will not be given until the towing airplane has reached a point 50 yards or less, measured horizontally on the ground from the firing line, and there is no danger of bullets striking the airplane. The signal or command for CEASE FIRING will be given before the sleeve target is 100 yards, measured horizontally, on the ground in advance of the firing line, so there is no danger of bullets dropping outside the firing area.

*e.* Whenever a towing cable breaks and the towing airplane is on a course which passes near the firing point, all



personnel in that vicinity will be warned to lie flat on the ground until danger from the loose cable and the release is passed.

*f.* No rifle will be pointed at or near the towing airplane. *All tracking will be on the towed target.* Muzzles will be depressed during loading.

*g.* At least two safety officers will be designated to assist the officer in charge of firing in carrying out safety precautions.

*h.* Firing will be permitted only when the smaller angle in space between the gun-target line and the tow line is greater than 45°.

*i.* An Air Corps officer should be at the firing point during an organization's initial practice for the season for the purpose of giving supplemental instruction and checking the safety measures taken.

*j.* Additional safety precautions are covered in AR 750-10.

■ 76. PROCEDURE OF FIRING.—*a.* The men to fire take the antiaircraft kneeling firing position on the firing line with at least 1½ yards between men.

*b.* The officer in charge of firing takes position in rear of the center of the firing line.

*c.* Safety officers take position at either flank of the firing line.

*d.* As the *towing airplane* approaches the left (right) side of the danger area, the officer in charge of firing gives the command: 1. (SO MANY) ROUNDS, LOAD, 2. SLEEVE TARGET APPROACHING FROM THE LEFT (RIGHT). Each rifleman loads and locks his piece.

*e.* As the *towed target* approaches the danger area, the officer in charge of firing commands: 3. — TARGET-LENGTH LEADS (using the necessary target-length leads). At this preparatory command, each rifleman unlocks his piece, aims by swinging through the sleeve to the announced lead, pivoting at the waist, and maintains his estimated lead.

*f.* In firing at crossing targets the safety officer stationed at the end of the firing line opposite to the target's approach signals or commands COMMENCE FIRING when the sleeve target has completely crossed the line marking the firing

area. The officer in charge of firing and such assistants as he desires repeat the command or signal to insure that all firers hear it. Each rifleman squeezes the trigger until the first shot is fired. He then continues to reload rapidly, re-aim, and fire until the command or signal **CEASE FIRING** is given. The safety officer at the end of the firing point opposite to the target's departure observes the flight of the sleeve target during the firing. When he observes that the sleeve is about to leave the danger area he signals or commands **CEASE FIRING**. The officer in charge of firing and his assistants repeat the command or signal to insure that all firers hear it.

*g.* In firing at overhead targets, the same procedure is followed except that the officer in charge of firing, from his position behind the center of the firing line, determines when firing commences and ceases. He gives the command or signal to **COMMENCE FIRING** when the towing airplane is 50 yards or less in advance of the firing line, and the command **CEASE FIRING** before the sleeve is 100 yards in advance of the firing line. (See par. 75.)

■ 77. **SCORING.**—*a.* The number of hits is found by dividing the number of holes in the target by two. An odd hole is counted as a hit.

*b.* The hit percentage is obtained by dividing the number of hits as obtained in *a* above by the total number of rounds fired at the target.

## SECTION VI

### RANGES, TARGETS, AND EQUIPMENT

■ 78. **RANGE OFFICER.**—A range officer is appointed well in advance of range practice. His chief duties are—

*a.* To make timely estimates for material and labor to place the range in proper condition for firing.

*b.* To supervise and direct the repairs and alterations to installations.

*c.* Where safety demands, to instruct and supervise range guards.

■ 79. MINIATURE RANGE.—*a.* The miniature range consists of—

- (1) One horizontal target. (Fig. 33.)

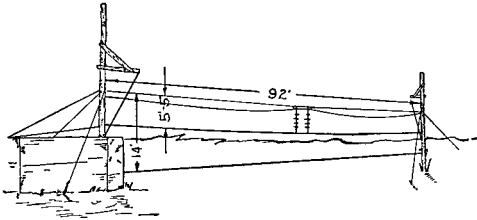

FIGURE 33.—Horizontal target

- (2) One double climbing and diving target. (Fig. 34.)

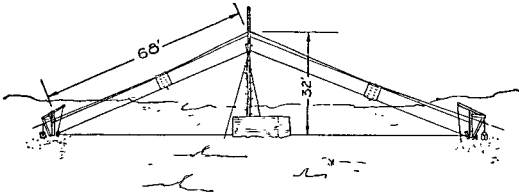

FIGURE 34.—Double climbing and diving target.

- (3) One overhead target. (Fig. 35.)

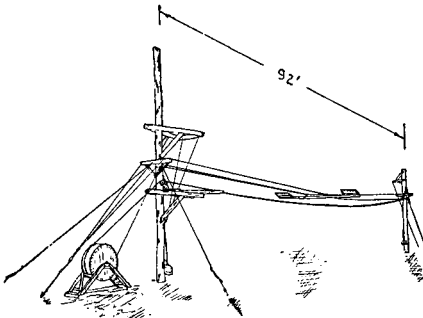

FIGURE 35.—Overhead target.

b. A suggested arrangement of the targets is shown in figure 36.

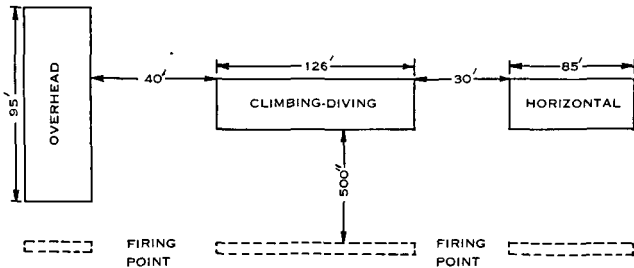

FIGURE 36.—Arrangement of targets.

c. For details of range apparatus see figures 38 to 43, inclusive.

d. *Danger area required.*—(1) The danger area required is dependent upon the type of ammunition. (See AR 750-10 for size and shape.)

(2) The miniature range may be laid out in the same manner as described in paragraph 80c. Care must be taken to insure that the firing line and targets are placed so that no fire will fall outside of the danger area.

e. *Equipment required.*—If the organization for training is as suggested in paragraph 65b, the following equipment is necessary:

64 caliber .22 rifles (if available).

4 aiming and leading targets (see fig. 31). (Each of these targets consists of a piece of beaverboard on which the silhouettes are pasted.)

6 instruction firing targets per range. (See fig. 32.) (These targets are the same as the aiming and leading targets except that the spotters are eliminated.)

1 score card per man as follows:

**INDIVIDUAL SCORE CARD**  
**ANTI-AIRCRAFT RIFLE MARKSMANSHIP**

Date\_\_\_\_\_ , 19\_\_\_\_\_

Name\_\_\_\_\_

Target	1 TL lead			2 TL lead			3 TL lead		
	Rounds fired	Hits	Per-cent	Rounds fired	Hits	Per-cent	Rounds fired	Hits	Per-cent
Horizontal.....									
Climbing.....									
Diving.....									
Overhead.....									
Total.....									

■ 80. TOWED-TARGET RANGE.—*a.* In selecting the location of a towed-target range the danger area is the chief consideration. (See AR 750-10.)

*b.* The firing point should accommodate at least 50 men in line with a 1½-yard interval between men. A level strip of ground, preferably on a hill, 75 yards long and 2 yards wide is suitable. A firing point similar to the firing point of a class A rifle range may be built.

*c.* (1) After the towed-target range has been selected, the firing point, limits of fire, and danger area should be plotted on a map or sketch of the area.

(2) From this map or sketch the range is then laid out on the ground. First, each end of the firing point is marked by a large stake. The right and left limits of fire are then each marked by a post. Each post is placed at the maximum distance at which it will be plainly visible from the firing point. When these distances have been determined, the posts are located in azimuth by the following method: To locate the post marking the left limit of fire, an aiming circle or other angle-measuring instrument is set up at the right end stake of the firing point. It is then oriented and laid on an azimuth

which, by reference to the map or sketch, is known to be the farthest to the left that the rifle at the right end of the firing point can safely be fired. The post marking the right limit of fire is similarly located with the instrument set up at the left end stake of the firing point. (See fig. 37.)

(3) Direction guides for the towing airplane to follow should, within the limits of fire, be distinctly marked on the ground for each course. White targets or strips of cloth placed flat on the ground about 30 feet apart are suitable.

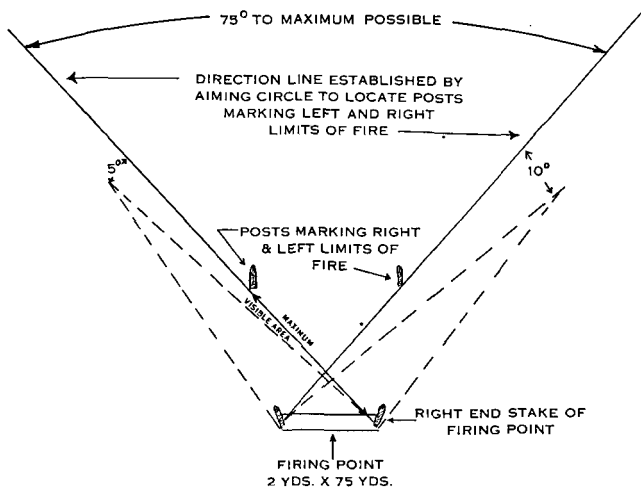

FIGURE 37.—Towed-target range showing firing point and limits of fire. Dotted lines show danger area.

■ 81. TOWED TARGETS.—*a. Type and source.*—The targets used in towed-target firing are sleeve targets furnished by the Air Corps unit assigned the towing mission. They are returned to the Air Corps unit after they have been scored.

*b. Towline.*—The towing line will be not less than 600 yards long.

■ 82. INSTRUCTIONS TO PILOTS FOR TOWING MISSIONS.—*a.* Towed-target firing requires the closest cooperation between the pilot of the towing airplane and the officer in charge of

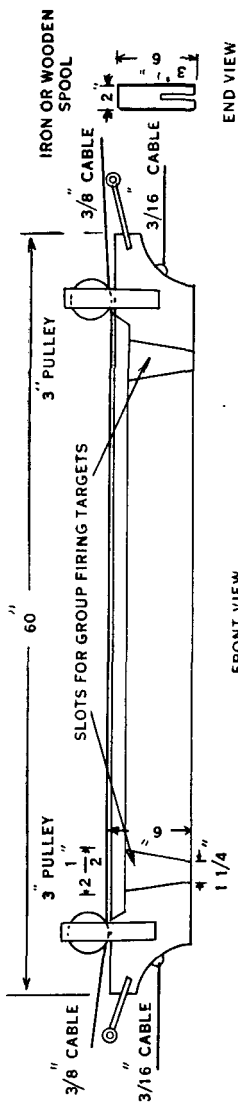

FIGURE 38.—Nonoverhead target carrier.

firing. Decisions affecting the safety of the airplane rest with Air Corps personnel.

b. The air mission for towed-target firing will be specifically stated. The commanding officer requesting airplanes for towed-target firing will furnish, in writing, to the Air Corps unit commander concerned the following information:

- (1) The place of firing.
- (2) The date and hour of firing.
- (3) The number of missions to be flown; altitude, course, speed, and number of runs for each.
- (4) The ground signals to be used.

(5) A map of the area with the firing line, angle of fire, danger area, the course of each mission, and the location of the grounds for dropping targets and messages, all plotted thereon. An alternate dropping ground will be designated when practicable, either or both dropping grounds being subject to approval by the pilot.

(6) The length of the towline, within limits established by the Air Corps, and subject to approval of the pilot.

(7) The number of sleeve targets required.

c. Whenever practicable to do so, the officer in charge of the firing will discuss with the pilot the detailed arrangements mentioned in *b* above. This discussion should take place on the

towed-target range where the various range features can be pointed out to the pilot. The courses over which the airplane is to be flown should be distinguished

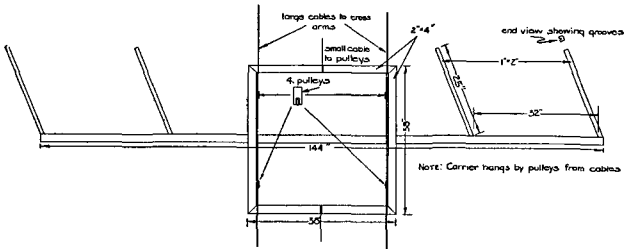

FIGURE 39.—Overhead target carrier.

on the ground (within the angle of fire). Machine-gun targets placed flat on the ground, about 30 feet apart, or strips of target cloth are practicable for this purpose on

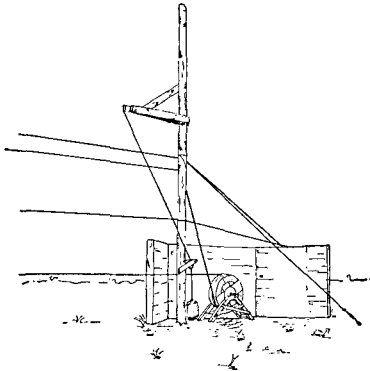

FIGURE 40.—Rear view of nonoverhead range butts, showing drum, guide wires, and bumper.

some courses. On others a terrain feature such as a black line may be used.

■ 83. SIGNALS.—*a.* Direct radio communication is the most effective means by which the officer in charge of towed-



target firing and the pilot of the towing airplane maintain contact with each other. Even though radio is being used, panels should be available in case radio communication fails.

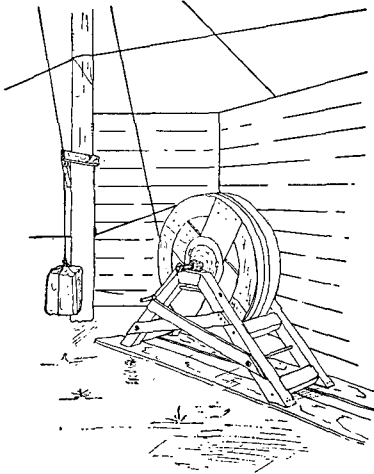

FIGURE 41.—Moving target drum. One complete turn moves target 15 feet.

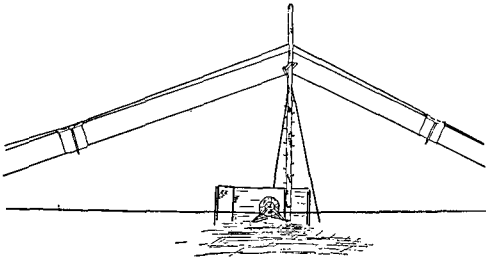

FIGURE 42.—Rear view of climbing and diving target.

b. For signaling from the ground to the pilot any method agreed upon by the officer in charge of firing and the pilot of the towing airplane may be used. The panel signals generally used are as follows:

Stand by.....	0 0 2
Ready fire.....	0 0 0
Repeat run No. 1.....	0 9 1
Repeat run No. 2.....	0 9 2
Repeat run No. 3.....	0 9 3
Repeat course.....	0 9 4
Mission complete.....	Pick up panels

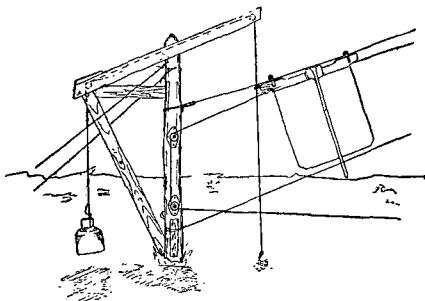

FIGURE 43.—Rear view of climbing and diving target and method of securing target to frame.

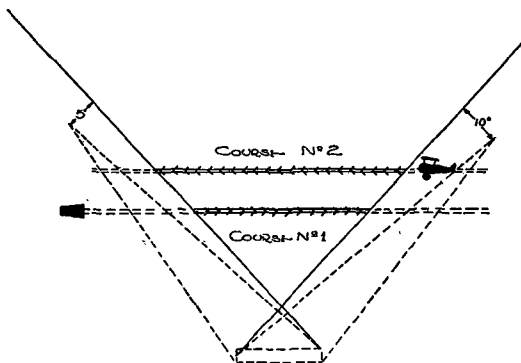

FIGURE 44.—Courses Nos. 1 and 2. Firing takes place when target is on shaded portion of course.

c. The pilot may also communicate with the officer in charge of firing by dropped messages or by rocking his wings.

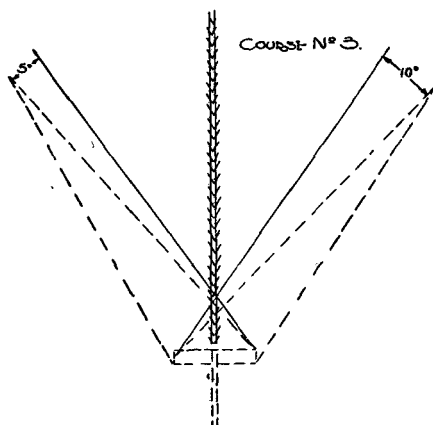

FIGURE 45.—Course No. 3. Firing takes place when target is on shaded portion. Fire is opened when towing airplane is 50 yards or less from firing point.

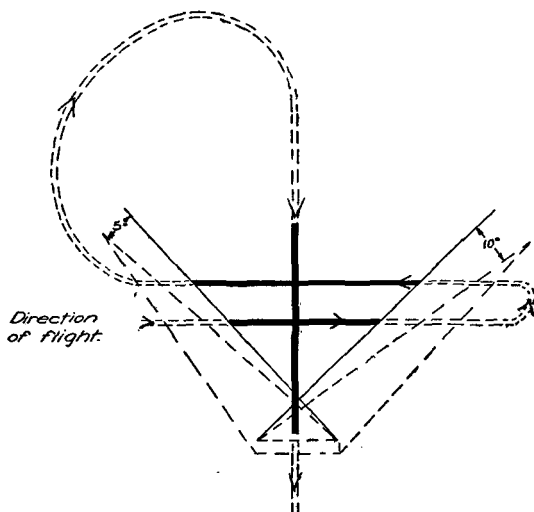

FIGURE 46.—Course No. 4. Heavy lines indicate when towed target is fired upon.

## CHAPTER 5

### TECHNIQUE OF RIFLE FIRE

	Paragraphs
SECTION I. General .....	84-86
II. Range estimation.....	87-91
III. Target designation.....	92-98
IV. Rifle fire and its effect.....	99-105
V. Application of fire.....	106-113
VI. Landscape-target firing.....	114-121
VII. Field-target firing.....	122-128
VIII. Fire exercises.....	129-131

#### SECTION I

#### GENERAL

■ 84. SCOPE.—*a.* The training of riflemen for combat is progressive in nature and includes three phases. The *first phase* is individual training and comprises such allied subjects as rifle marksmanship, extended order, signals, and certain elements of scouting and patrolling. The *second phase* is called "technique of fire" and is team training consisting of instruction in the application and control of the collective fire of rifle fire units. In the *third phase* the individual and team training learned in the first and second phases is combined with tactical training; this phase is called combat firing. This chapter deals with the second phase of training.

*b. Collective fire* is the combined fire of a group of individuals.

*c. A fire unit* is one whose fire in battle is under the immediate and effective control of its leader. The usual rifle fire unit is the squad.

■ 85. IMPORTANCE OF RIFLE FIRE.—Effective rifle fire is a characteristic of successful Infantry and is an element which may determine the issue of battle. Collective fire is most effective when it is the product of teamwork. Training in the technique of fire, as set forth in this chapter, is designed

to train rifle squads to act as efficient and dependable teams in the application and control of collective fire.

■ **86. PROGRESSIVE STEPS.**—*a.* This training is conducted without regard to tactical considerations. However the application of the training to tactical situations should be kept in mind. Instruction is progressive and is divided into six consecutive steps. Each step includes some, or all, of the technique learned in previous steps. The steps are as follows:

- (1) Range estimation.
- (2) Target designation.
- (3) Rifle fire and its effect.
- (4) Application of fire.
- (5) Landscape-target firing.
- (6) Field-target firing.

*b.* A 13-week training schedule for mobilization should include about 36 hours for this instruction.

*c.* It is not essential that perfection be reached in each step before proceeding to the next step; it is better that such a standard be attained by repetition, applying in the steps that follow, everything that has been learned. However, each step should be understood before proceeding to the next. The instructor explains each step in detail. He then makes plain its relation to the subject as a whole. This is followed by a demonstration which in turn is explained by the instructor. The troops then practice the principles and methods previously explained and demonstrated. Exercises pertaining to each step are hereinafter described in detail. They can be used for demonstrations and instructional practice. Some of them can be used to test fire units, thus introducing the desirable element of competition. These exercises may be changed to conform to local conditions.

## SECTION II

### RANGE ESTIMATION

■ **87. IMPORTANCE.**—In battle, ranges are seldom known in advance, so that the effectiveness of fire depends in large measure upon the accuracy of range estimation.

■ 88. METHODS.—Of the various methods of estimating ranges, only the following are considered in instruction in the technique of rifle fire:

- a. Use of tracer bullets.
- b. Observation of fire.
- c. Estimation by eye.

■ 89. USE OF TRACER BULLETS.—When the range to a target is being estimated by the use of tracer bullets, the scout or leader first estimates the range by eye, fires a tracer bullet, corrects the sight-setting according to the strike of the bullet, and continues to fire and correct the sight-setting until a tracer appears to strike the target. The estimator then announces the correct range after due consideration of the zero of his rifle.

■ 90. OBSERVATION OF FIRE.—This method can be used when the ground is dry and the strike of the bullets is indicated. The same procedure is followed as in determining the range by tracer bullets. The following points must be taken into consideration:

- a. Dust will appear slightly above the striking point of the bullet.
- b. If observing from the firing point, dust will appear on the side toward which the wind is blowing.
- c. If observing from a point on the flank, shots which pass over the objective will appear to strike on the side toward which the observer is posted; those which fall short, toward the opposite side.

■ 91. ESTIMATION BY EYE.—*a. Necessity for training.*—The usual method of estimating ranges in combat is estimation by eye. Untrained men make an average error of 15 percent of the range when estimating by eye. Hence a definite system of range estimation, coupled with frequent practice on varied terrain, is essential to success with this method.

*b. Unit-of-measure method.*—(1) Ranges less than 500 yards are measured by applying a mental unit of measure 100 yards long. Thorough familiarity with the 100-yard unit, and with its appearance on varied terrain and at different distances, is necessary if the soldier is to apply it accurately.

(2) Ranges greater than 500 yards are estimated by selecting a point halfway to the target, applying the unit of measure to this halfway point, and doubling the result.

(3) The average of a number of estimates by different men will generally be more accurate than a single estimate. This variation of the suggested method is used when time permits, by taking the average of the estimates of members of the squad or of specially qualified men.

*c. Appearance of objects.*—In some cases much of the ground between the observer and the target will be hidden from view, and the application of the unit of measure will be impossible. In such cases the range is estimated by the appearance of objects. Whenever the appearance of objects is used as a basis for range estimation, the observer must make allowance for the following effects:

(1) Objects seem nearer—

(a) When the object is in a bright light.

(b) When the color of the object contrasts sharply with the color of the background.

(c) When looking over water, snow, or a uniform surface like a wheat field.

(d) When looking downward from a height.

(e) In the clear atmosphere of high altitudes.

(f) When looking over a depression most of which is hidden.

(2) Objects seem more distant—

(a) When looking over a depression most of which is visible.

(b) When there is a poor light or fog.

(c) When only a small part of the object can be seen.

(d) When looking from low ground upward toward higher ground.

*d. Exercises.*—(1) *No. 1.*—(a). *Purpose.*—To familiarize the soldier with the unit of measure, 100 yards.

(b) *Method.*—The unit of measure, 100 yards, is previously staked out over varied ground, using markers that will be visible up to 500 yards. The men are required to become thoroughly familiar with the appearance of the unit of measure from the prone, kneeling, and standing positions at various ranges. They do this by moving away from and in prolongation of the lines staked out and by studying the

appearance of the unit from distances of 100, 200, 300, and 400 yards.

(2) No. 2.—(a) *Purpose*.—To illustrate the application of the unit of measure.

(b) *Method*.

1. Ranges up to 900 yards are measured accurately and marked at every 100 yards by large markers or target frames, each bearing a number to indicate its range. Men undergoing instruction are then placed about 25 yards to one side of the prolonged line of markers and directed to place a hat or other object before their eyes so as to exclude from view all of the markers. They are then directed to apply the unit of measure five times along a straight line parallel to the line of markers. When they have selected the final point the eye cover is removed, and the estimations of the successive 100-yard points and the final point are checked against the markers. Accuracy is gained by repeating the exercise.

2. Ranges greater than 500 yards are then considered. With the markers concealed from view men estimate the ranges to points which are obviously over 500 yards distant and a little to one side of the line of markers. As soon as they have announced each range they remove their eye covers and check the range to the target and to the halfway point by means of the markers. Prone, sitting, or kneeling, and standing positions are used during this exercise.

(3) No. 3.—(a) *Purpose*.—To give practice in range estimation.

(b) *Method*.—From a suitable point, ranges are previously measured to objects within 1,000 yards. The men are required to estimate the ranges to the various objects as they are pointed out by the instructor, writing their estimates upon paper previously issued. At least  $\frac{1}{2}$  of the estimates are made from the prone or sitting positions. Thirty seconds are allowed for each estimate. When all ranges have been estimated the papers are collected and the true ranges



announced to the class. To create interest, individual estimates and squad averages may be posted on bulletin boards.

### SECTION III

#### TARGET DESIGNATION

■ 92. **IMPORTANCE.**—Target designation is a vital element in technique of fire. Battlefield targets are generally so indistinct that leaders and troops must be able to designate their location and extent. Enemy troops will usually be so well-concealed that the location of most individuals of the hostile unit will not be visible. To cover such a target, squad leaders must be able to designate the area in which hostile troops are located, and members of the squad must be trained to place a heavy fire on the designated area even though no specific targets are visible.

■ 93. **INSTRUCTION.**—Prior to instruction in target designation, riflemen should understand the topographical terms normally employed in designating targets; for example, crest, military crest, hill, cut, ridge, bluff, ravine, crossroads, road junction, road center, road fork, skyline, etc.

■ 94. **METHODS.**—*a.* The following methods are used to designate targets:

- (1) Tracer bullets.
- (2) Pointing.
- (3) Oral descriptions.

(4) A combination of any or all of methods in (1), (2), and (3) above. The method used will depend on the position of members of the squad at the time the target appears. The principles governing selection of method are clarity and simplicity.

*b.* Troops should be trained in *all* the methods of target designation (pars. 95 to 97, incl.). The simplest form is the most effective.

■ 95. **TRACER BULLETS.**—*a.* The use of tracer bullets is a quick and sure method of designating an obscure battlefield target. Their use is invariable when scouts or other members of the squad are already under fire, when the squad

is deployed and separated, and out of voice range of the leader, or when cover is scarce, and pointing or other movement will expose personnel to hostile fire. Their use, however, has limitations, for they may disclose the position of the firer to the enemy; further, the effect of a sudden burst of fire is lessened by preceding it with tracers. Tracer bullets are also the most accurate method of indicating the flanks of an obscure target.

b. To designate a point target by this method, the scout or leader announces "Range 500, watch my tracer," and fires a tracer at the target. The flanks are indicated by firing tracer bullets at each flank, announcing each such shots as "Left flank, right flank." Any range correction obtained by tracer firing should be announced.

■ 96. POINTING.—Targets may be pointed out either with the arm or the rifle. Pointing may be supplemented by oral description. To use the rifle for this purpose, it is canted to the right and aimed at the target. The head is then straightened up without moving the rifle. A soldier standing behind looks through the sights and locates the target. If time permits, a bayonet can be stuck in the ground as a rest for a rifle aimed at the target. In pointing, the range is always announced. Usually some supplementary description will be necessary.

■ 97. ORAL DESCRIPTION.—*a. Use.*—Oral description is often used by leaders to designate targets to their units. Battlefield conditions will rarely permit the leader to designate a target direct to all members of his unit by this method. For this reason either pointing or tracers are frequently used in combination with oral description.

*b. Elements of oral target designation.*—The elements of oral target designation are—

- (1) Range.
- (2) Direction.
- (3) Description of target.

These elements are always given in the above sequence with a slight pause between each element. An exception to this rule occurs when the target is expected to be visible for a short time only. In this case the target is pointed out as

quickly as possible; for example, such an oral target designation might be "Those men." (Fig. 47.) When the range is announced, men immediately set their sights before looking for the target.

*c. Direction.*—The terms *front* (left front, right front, left flank, right flank) may be used to indicate the general direction of the target. When necessary, the direction is fixed more accurately by methods described hereafter.

*d. Simple description.*—When the target is plainly visible, or at an easily recognized point, as illustrated in figure 47, a simple description is used; for example (target at A):

Range: 425.

Left front.

Sniper at base of dead tree.

*e. Reference point.*—When the target is indistinct or invisible, and is not located at some prominent point, the direction of the target is indicated by the use of a reference point. This is an object, preferably a prominent one, by reference to which the location of other points may be determined. In selecting a reference point, care must be taken that another similar object is not mistaken for the one intended. A reference point on a line with the target and beyond it will give greater accuracy than one between the observer and the target. For brevity a reference point is called reference.

(1) *When reference point is on line with target.*—The description takes the following form (fig. 47, target at B).

Range: 450.

Reference: church spire.

Target: machine gun in edge of woods.

It will be noted that the range announced is that to the target and not to the reference point. When the word "reference" is used the word "target" is also used to differentiate between the two objects. Another example follows (fig. 47, target at C):

Range: 350.

Left front.

Reference: black stump.

Target: sniper on far side of road.

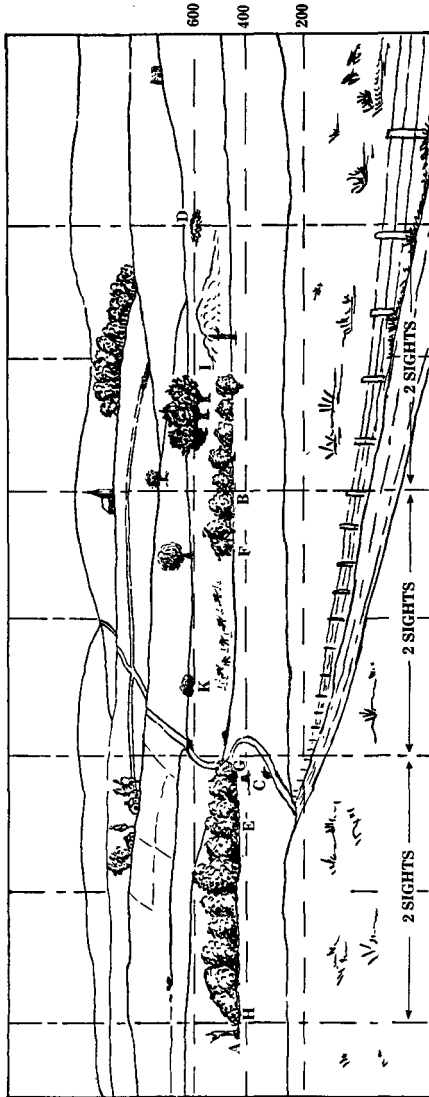

FIGURE 47.

(2) *When reference point is not on line with target.—(a)*

In this, it is necessary to indicate the distance to the right or left of the reference point at which the target is located. This distance is measured in units called sights (see par. 98b). Suppose that the rifle is pointed so that the left edge of the raised sight leaf is on line with the reference point and it is found that the right edge of the sight leaf is in line with the target, the target is then one sight width to the right of the reference point and it is announced as "Right, one sight." If the sight can be applied one and one-half times in the above manner, the target is "Right, one and one-half sights." The following examples illustrate this method (fig. 47):

(Target at D)—

Range: 600.

Reference: church spire. Right, two sights.

Target: group of enemy in shell hole near crest.

(Target at E)—

Range: 425.

Left front.

Reference: dead tree. Right one and one-half sights.

Target: sniper in edge of woods.

(Target at F)—

Range: 450.

Reference: church spire, left one-half sight.

Target: machine gun in corner of woods.

(b) The width or extent of targets is also measured in sights (fig. 47, target G to H):

Range: 425.

Reference: church spire; left two sights.

Target: enemy groups in edge of woods extending left two sights.

(3) Successive reference points may be used instead of sight measurements from one reference point (fig. 47, target at I):

Range: 500.

Reference: church spire; to the right and at a shorter range, group of three trees; to the right and at the same range.

Target: machine gun at left end of mound of earth.

(4) Combination of successive reference points and sights.—

Example (fig. 47, target at K):

Range: 600.

Reference: church spire; to the left and at a shorter range, lone tree; left one sight and at the same range.

Target: machine gun in clump of brush.

*f. Variations.*—If one end of a target is considerably nearer than the other, the average range is announced, since dispersion will cover the target. Battlefield conditions will impose many practical substitutions and combinations of methods in target designation. Frequently the squad leader will be able to designate the target to only one or two members of his squad. Therefore, each member of the squad must be taught to assist in designating the targets to other members of the squad team. At times the entire target designation will be furnished by the scouts to other members of the squad as they arrive in the vicinity. Formal, long winded oral target designation will often confuse more than help.

■ 98. EXERCISES.—*a. No. 1.*—(1) *Purpose.*—To afford practice in target designation by means of tracer bullets.

(2) *Method.*—(a) On a class A or class B range a concealed target representing a machine gun is placed near a pit or other bulletproof shelter. About 500 yards in front of the target a firing position suitable for a squad is selected. The location of the target will be visible from the firing position, but the target itself may be invisible due to its concealment. This concealment should have a natural appearance in order not to attract attention.

(b) The squad is deployed along the firing position and all except the scouts are then faced to the rear.

(c) The scouts take the prone position and are told that the waving of a red flag to their front will represent the firing and smoke from the machine gun.

(d) A man stationed in the pit waves a flag in front of the target for about 30 seconds and retires to the protection of the pit.

(e) The squad is faced to the front and men take the prone position. Rifles are loaded, the scouts using tracer ammunition and the remainder of the squad ball cartridges.

(f) The scouts point out the target by firing tracers and announce the range, which is passed orally from man to man.

(g) As soon as each man understands the location of the target he opens fire with the proper sight setting.

(h) The instructor causes firing to cease shortly after all the men are firing.

(i) Noncommissioned officers do not participate in the fire. Squad leaders move about freely behind their men and observe the firing. The second in command assists the squad leader.

(j) After firing ceases, sight settings are checked by the squad leader and the target is examined or the hits are signaled to the squad.

b. No. 2.—(1) *Purpose*.—To teach the use of sights and fingers for lateral measurement.

(2) *Method*.—(a) A number of short vertical lines 1 foot apart are plainly marked on a wall or other vertical surface. At a distance of 20 feet from the wall a testing line is drawn or marked out by stakes. The instructor explains that the vertical lines are one sight (50 mils) apart when measured from the testing line, so that the correct distance from the rifle sight leaf to the eye can be determined by pointing the rifle at the vertical lines and moving the eye along the stock until the raised sight leaf covers the space between one of the vertical lines and the next line to the right or left. The instructor demonstrates with a rifle while explaining.

(b) The men take positions on the testing line and each determines the proper distance of his eye from the sight as explained by the instructor. The position of the eye with reference to the stock is carefully noted or marked on the stock. (This will usually be about 14 inches from the eyes.)

(c) The instructor then explains and demonstrates the use of fingers in measuring sights. First he holds his hand, with palm to rear and fingers pointing upward, at such distance from his eye that each finger will measure one sight on the wall. Then he lowers his hand to his side without changing the angle of the wrist or elbow and notes the exact point at

which the hand strikes the body. Thereafter when measuring with the fingers he first places his hand at this point and raises his arm to the front without changing the angle of the wrist or elbow. His hand will then be in the correct position for measuring sights by fingers. The men determine the proper distance of fingers from the eye as explained by the instructor.

(d) Practice in lateral measurement is given, using convenient objects within view and using both sights and fingers.

*c. No. 3.—(1) Purpose.*—To afford practice in target designation by pointing with the rifle.

(2) *Method.*—(a) The squad is formed faced to the rear. The instructor then points out the target to the squad leader, who takes the kneeling or prone position, estimates the range, adjusts his sight, alines his sights on the target, and then calls "Ready."

(b) The members of the squad then move in turn to a position directly behind the squad leader and look through the sights until they have located the target. The range is given orally by the squad leader to each individual.

(c) As soon as each man has located the target he moves to the right or left of the squad leader, sets his sight, places his rifle on a bayonet rest or sandbag, and alines his sights on the target.

(d) The instructor, assisted by the squad leader, verifies the sight setting and the alinement of the sights of each rifle.

*d. No. 4.—(1) Purpose.*—To afford practice in target designation by oral description.

(2) *Method.*—(a) The squad is deployed faced to the rear. The squad leader is at the firing point, where sandbags or bayonet rests have been provided for each rifle.

(b) At a prearranged signal the target is indicated by the display of a flag. When the squad leader states that he understands the position of the target the flag is withdrawn.

(c) The squad is then brought to the firing point, placed in the prone position, and each man required to set his sight, use the sandbag or bayonet rest, and sight his rifle on the target according to the oral description of the squad leader. The squad leader gives his target designation from the prone position.



(d) The squad leader's designation is checked from the ground. The men are required to leave their rifles on the rests, properly pointed, until checked by the instructor or squad leader.

#### SECTION IV

#### RIFLE FIRE AND ITS EFFECT

■ 99. **TRAJECTORY.**—*a. Nature.*—The trajectory is the path followed by a bullet in its flight through the air. The bullet leaves the rifle at a speed of 2,700 feet per second. Because of this great speed the trajectory at short range is almost straight or flat.

*b. Danger space.*—The space between the rifle and the target in which the trajectory does not rise above a man of average height is called the danger space. The trajectory for a range of 700 yards does not rise above 68 inches. Therefore, it is said that the danger space for that range is continuous between the muzzle of the gun and the target. For ranges greater than 700 yards, the bullet rises above the height of a man standing, so that only parts of the space between the gun and the target are danger spaces. (Fig. 48.)

■ 100. **DISPERSION.**—Because of differences in ammunition, aiming, holding, and wind effects, a number of bullets fired from a rifle at a target are subject to slight dispersion. The trajectories of those bullets form an imaginary cone-shaped figure called the cone of dispersion.

■ 101. **SHOT GROUPS.**—When the cone of dispersion strikes a vertical target it forms a pattern called a vertical shot group. A shot group formed on a horizontal target is called a horizontal shot group. Due to the flatness of the trajectory, horizontal shot groups on level ground vary in length from 100 to 400 yards depending upon the range.

■ 102. **BEATEN ZONE.**—The beaten zone is the area on the ground struck by the bullets forming a cone of dispersion. When the ground is level, the beaten zone is also a horizontal shot group. The slope of the ground has great effect on the shape and size of the beaten zone. Rising ground shortens the beaten zone. Ground that slopes downward

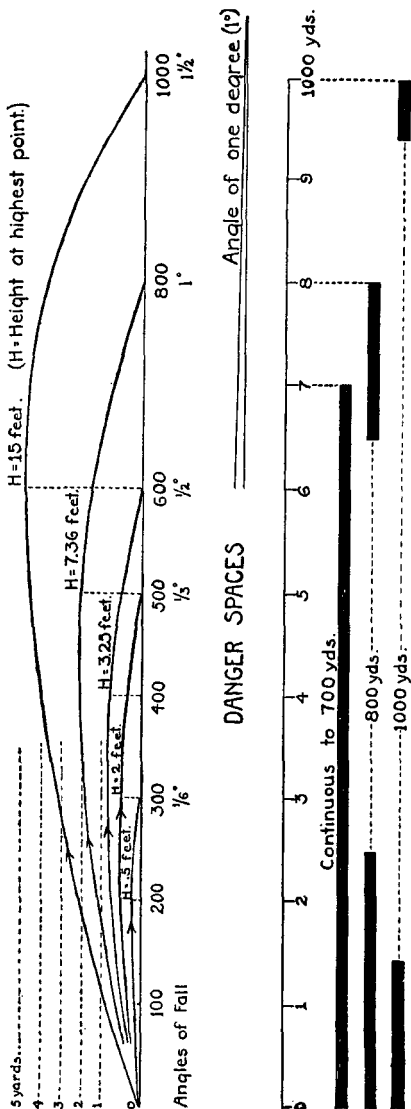

FIGURE 48.—Trajectory diagram (vertical scale is 20 times horizontal scale).

and in the approximate curve of the trajectories will greatly lengthen the beaten zone. Falling ground with greater slope than the trajectory will escape fire and is said to be in defilade.

■ 103. CLASSES OF FIRE.—*a.* Fire as regards direction is classified as follows:

(1) *Frontal*.—Fire delivered on the enemy from his front.

(2) *Flanking*.—Fire delivered on the enemy from his flank.

*b.* Fire, as regards trajectory is classified as follows:

(1) *Grazing*.—Fire approximately parallel to the ground and close enough thereto to strike an object of a given height. The average height of a man is usually taken as the determining factor.

(2) *Plunging*.—Plunging fire is fire in which the angle of fall of the bullets with reference to the slope of the ground is such that the danger space is practically confined to the beaten zone and the length of the beaten zone is materially lessened. Fires delivered from high ground on ground lying approximately at right angles to the cone of fire, or against ground rising abruptly to the front with respect to the position of the rifle, are examples of plunging fire. As the range increases, fire becomes increasingly plunging because the angle of fall of the bullets becomes greater.

(3) *Overhead*.—Fire delivered over the heads of friendly troops.

*c. Comparison*.—Flanking fire is more effective than frontal fire. Grazing fire is more effective than plunging fire because the beaten zone is much longer. Overhead fire with the rifle is unusual and may be employed only when the ground affords protection to the friendly troops.

■ 104. EFFECT OF FIRE.—By making use of cover and of the supporting fires of the artillery, mortars, and machine guns, rifle units will get as near the enemy as possible without opening fire. Normally this should be at ranges less than 600 yards. A ricochet is effective if it strikes a man soon after it leaves the ground. Rifle fire is effective and should be used against low-flying airplanes. The effect of fire on moving targets is covered in chapters 3 and 4. Even though hits can no longer be made, fire may be continued when the

moral effect is sufficient to keep the enemy under cover and render his fire ineffective. When opposing forces are entrenched and neither side is trying to advance, fire for moral effect alone is of no value.

■ 105. EXERCISE.—*a. Purpose.*—To show trajectories.

*b. Method.*—The unit under instruction watches the firing of a few tracer bullets at targets whose ranges are announced. Ranges of 300, 600, and 800 yards are suitable selections. The flatness of the trajectories is called to the attention of the men.

## SECTION V

### APPLICATION OF FIRE

■ 106. GENERAL.—*a.* Fire and movement are combined in the combat action of the rifle squad and larger rifle units. The application of fire by such units is essential to their success.

*b. Application of fire in the attack.*—In the attack the fire of a rifle unit is generally advanced by smaller groups or by individuals. Irregular formations are usually employed. The unit will apply its fire progressively as small groups or individuals advance or work their way forward to new firing positions covered by the fire of men in place. The squad and smaller groups must be trained to place a large volume of accurate fire upon probable enemy locations and indistinct or concealed targets such as enemy machine guns or small groups. The squad and smaller groups must be trained to apply such fire quickly upon the order or signal of its leader and in appropriate circumstances to apply it without such order. It must be further understood by all that after fire is opened by a small group it will be maintained and the attack continued by the action of leaders and by individual initiative.

*c. Application of fire in the defense.*—In defense the fire of a small rifle unit such as a squad is delivered by small groups and individuals from positions which they must hold. They are placed to secure good fields of fire and to take advantage of cover and concealment.

d. The conditions in *b* and *c* above should be considered in the preparation of all exercises and an endeavor made to portray, as nearly as possible, battlefield conditions.

e. Considering the foregoing in the occupation of a firing position, the location of squads in the platoon area should be made with due regard to the following requirements. When these requirements conflict, it is the duty of leaders to weigh the importance of each and make the best dispositions possible under the conditions.

(1) Good field of fire to the front.

(2) Use of cover and concealment.

(3) An indefinite and inconspicuous formation which will suit the terrain and be hard to see.

(4) Control of fire by unit leader.

■ 107. CONCENTRATED AND DISTRIBUTED FIRE.—The size and nature of the target presented may call for the firepower of the entire group or only certain parts. The fire of a group must necessarily be either concentrated or distributed fire.

a. *Concentrated fire*.—Concentrated fire is fire directed at a single point. This fire has great effect but only at a single point. Machine guns and other automatic weapons are examples of suitable targets for concentrated fire.

b. *Distributed fire*.—(1) Distributed fire is fire distributed in width for the purpose of keeping all parts of the target under effective fire. It is habitually used on targets having any considerable width.

(2) The method of fire distribution employed by a squad is given below:

Each rifleman fires his first shot on that portion of the target corresponding generally to his position in the squad. He then distributes his remaining shots to the right and left of his first shot, covering that part of the target on which he can deliver accurate fire without having to change position. The amount of target each rifleman can cover will depend upon the range and the position of the firer. In some cases each rifleman will be able to cover the entire target with accurate fire. Fire is not limited to points known to contain an enemy; on the contrary, riflemen space their shots so that no portion of the target remains unmolested. This method of fire distribution is employed

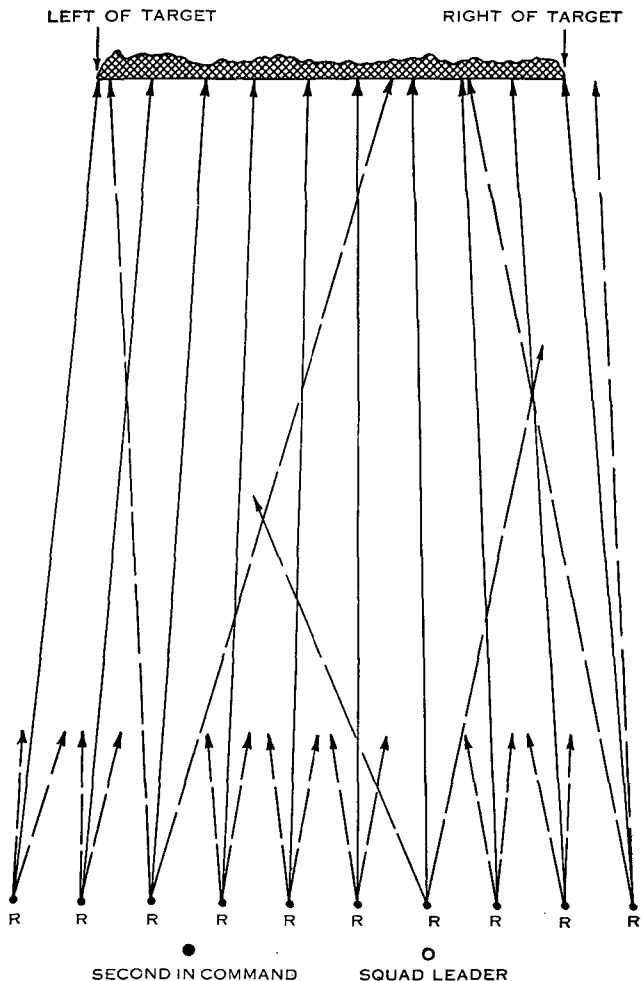

FIGURE 49.—Fire distribution of squad.

NOTE.—Each "R" in the figure represents a rifleman of the squad in position. Solid lines indicate direction of fire for first shot; broken lines illustrate sectors of fire.

without command. It enables squad leaders to distribute the fire of their units so as to cause the entire target to be kept under fire. (See fig. 49.)

(3) If a squad is employing this method of fire distribution and other targets appear, the squad leader announces such changes in the fire distribution as are necessary.

(4) If engaging the same target, all squads of the platoon distribute fire in the same manner.

■ 108. ASSAULT FIRE.—Assault fire is that fire delivered by the unit advancing at a walk. Riflemen halt individually and aim and fire standing. They go forward a few steps, halt, and fire again, keeping on a general line. They load while advancing. Bayonets are fixed before taking up the assault fire.

■ 109. RATE OF FIRE.—*a. General.*—The soldier fires at the rate of fire most effective under existing conditions. To exceed this rate is a waste of ammunition.

*b. Rifle.*—In rapid fire practice the soldier is trained to shoot from 7 to 10 shots per minute, depending upon the range. This rate is increased to from 10 to 15 shots per minute as the soldier gains experience.

■ 110. FIRE DISCIPLINE.—*a.* Fire discipline is a state of order, coolness, efficiency, and obedience existing among troops engaged in a fire fight. When fire discipline is good, men fight as they have been trained to fight and obey orders promptly and carefully; they resist and overcome the influence of danger, excitement, and confusion. Fire discipline is necessary for proper control by leaders and upon this control depend teamwork and effectiveness of the collective fire of the unit. The training necessary to insure good fire discipline cannot be completed during the brief period devoted to technique of fire. Training in fire discipline starts with the soldier's first drill and continues throughout his military training. Any drill or exercise which develops alertness and the habit of obedience or other soldierly qualities will aid in developing the character essential to fire discipline.

*b.* Fire discipline is maintained by leaders chiefly by their example of coolness and courage. Replacement of cas-

ualties is an element of fire discipline which keeps the unit working as a team in spite of losses. If any group of individuals find themselves without a leader, it is essential that one of them assume leadership of the group and carry out its mission or attach it to the nearest organized unit. An individual separated from his squad fights on his own initiative only when he has reason to believe that his single effort will accomplish some important result. Otherwise he reports to the nearest leader at once.

c. Fire discipline in the squad is the responsibility of the squad leader; he is assisted by the second-in-command. The position of the squad leader during the fire fight will be where he can best control his squad. The second-in-command will be where he can best assist the squad leader.

■ 111. FIRE CONTROL.—*a.* Fire control pertains to the squad or smaller group. Its application to the platoon as a whole will be exceptional. Fire control consists of the initiation and supervision of the fire of the squad or smaller group by its leader. By initiating such fire on order or signal the full effect of surprise can be secured. On the other hand the irregular formations adopted for an advance will often render such action impracticable. In such case fire must be opened and maintained on the initiative of individuals as circumstances require. In any case the leader of the squad or smaller group must supervise and seek to control the fire of his men so that it is directed and maintained at suitable targets. All must understand that controlled fire is always the most effective.

*b. How exercised.*—Squad leaders, assisted by their seconds-in-command, exercise fire control by means of orders, commands, and signals. The signals most frequently used are—

SIGNALS FOR RANGE.

COMMENCE FIRING.

FIRE FASTER.

FIRE SLOWER.

CEASE FIRING.

ARE YOU READY?

I AM READY.

FIX BAYONETS.



■ 112. FIRE ORDERS.—*a. Purpose.*—The leader of a rifle fire unit or group of riflemen having made a decision to fire on a target must give certain instructions as to how the target is to be engaged. The instructions by which the fire of a squad is directed and controlled form the fire order.

*b. Basic elements of a fire order.*—A fire order contains three basic elements which are announced or implied in every case. Only such elements or parts thereof will be included as are essential. The sequence is always as follows:

Target-designation element.

Fire-distribution element.

Fire-control element.

(1) *Target-designation element.*—The target may be designated by any one, or a combination, of the prescribed methods. (See pars. 92 to 98, incl.)

(2) *Fire-distribution element.*—The fire-distribution element is normally omitted from the fire order to fire units. The method of fire distribution described in paragraph 107 *b* is employed habitually in the absence of instructions to the contrary. When necessary, the fire-distribution element includes the subdivision of the target. For example—

(*a*) A squad leader desires to engage two machine-gun nests; the distribution element of his order might be as indicated by the italic words below:

Range: 500.

Front.

Machine gun at base of lone pine.

*Cooper, Emerson, Crane, Hines, Jones, your target.*

Range: 500.

Left flank.

Machine gun at base of haystack.

*Brown, Smith, Turner, Howard, Stone, your target.*

(*b*) The squad leader may engage two targets by placing half of the squad under the command of the assistant squad leader and directing him to engage one target, while he engages the other target with the other half of the squad.

(3) *Fire-control element.*—The fire-control element normally consists initially of merely the command or signal COMMENCE FIRING or FIRE AT WILL. It may include the number of rounds. Other fire-control elements are—

AT MY SIGNAL (followed by hand signal).

FIVE ROUNDS, FIRE AT WILL.

(4) Example of a complete fire order:

(a) *Target-designation element.*

(Range)

Range: 600.

(Direction)

Reference: right edge of lone building. Right one sight.

(Description of target) Target: group of enemy.

(b) *Fire-distribution element.*

(Implied)

(c) *Fire-control element.*—FIRE AT WILL.

■ 113. DUTIES OF LEADERS.—The following summary of duties of leaders relates only to their duties in the technique of fire.

*a. Squad leader.*—(1) Carries out orders of platoon leader.

(2) Selects firing positions for squad.

(3) Designates targets and issues fire orders.

(4) Controls fire of squad.

(5) Maintains fire discipline.

(6) Observes targets and effect of fire.

*b. Second-in-command.*—(1) Carries out orders of squad leader.

(2) Assists the squad leader to maintain fire discipline.

(3) Assumes command of squad in absence of squad leader.

(4) Participates in firing when the fire of his rifle is considered more important than other assistance to the squad leader.

## SECTION VI

### LANDSCAPE-TARGET FIRING

■ 114. SCOPE AND IMPORTANCE.—*a.* After satisfactory progress has been made in the preceding steps, the soldier may be given practice in the application of those lessons by firing at landscape targets.

*b.* The advantages of this training are as follows:

(1) Immediate supervision over all members of the firing unit is made possible by their close proximity. The instruction is therefore more individual than would be otherwise possible.

(2) The accessibility and nature of the targets permit the application and effect of the fire to be shown in a minimum of time.

(3) This form of instruction lends itself to indoor training when lack of facilities or weather conditions make it desirable.

c. In circumstances where there is a choice between landscape-target firing as covered in this section and field-target firing as covered in section VII the latter is to be preferred. Firing at landscape targets is therefore not required as a part of training.

■ 115. DESCRIPTION OF TARGET.—A landscape target is a panoramic picture of a landscape, and is of such size that all or nearly all of the salient features will be recognizable at a distance of 1,000 inches. The standard target is the series A target of five sheets in black and white.

■ 116. WEAPONS TO BE USED.—Firing at landscape targets should be with caliber .22 rifles, preferably the M1922M2 equipped with the Lyman receiver sight. When a sufficient number of those rifles are not available, the caliber .30 rifles may be used.

■ 117. PREPARATION OF TARGETS.—*a. Mounting.*—(1) The sheets are mounted on frames made of 1- by 2-inch dressed lumber, with knee braces at the corners. The frames for the target sheets are 24 by 60 inches. These frames are covered with target cloth which is tacked to the edges.

(2) The target sheets are mounted as follows: Dampen the cloth with a thin coat of flour paste and let it dry for about an hour; apply a coat of paste similarly to the back of the paper sheet and let it dry about an hour; apply a second coat of paste to the back of the paper and mount it on the cloth; smooth out wrinkles, using a wet brush or sponge, and work from the center to the edges. The frame must be placed on some surface which will prevent the cloth from sagging when the paper is pressed on it. A form for this purpose can easily be constructed. It must be of the same thickness as the lumber from which the frames are built and must have approximately the same dimensions as the aperture of the target frame.

*b. Target frames.*—Panels mounted as described above are set in a vertical frame consisting of posts (about 4 by 4 inches) of sufficient height, placed upright in the ground, 5 feet from center to center, with horizontal pieces of 2 by 4 inches to support the panels, braced to insure stability. The panels are supported by cleats and dowels in order to allow for easy removal.

*c. Range indicators.*—In order to make all elements of target designation complete, assumed ranges must be used on landscape targets. Small cards on which are painted appropriate numbers representing yards of range are tacked along one or both edges of a series of panels. The firers must be cautioned that the range announced in any target designation is for the sole purpose of designating the target, and that the sight setting necessary to zero their rifles must not be changed.

*d. Direction cards.*—In order to provide the direction element in oral target designation, small cards on which are painted Front, Right front, Left front, Right flank, Left flank are tacked above the appropriate panels of the landscape series.

*e. Scoring devices.*—(1) A squad may be brought up to the target and there view the results of its firing. Scoring the exercises will tend to create competition between squads and will enable the instructor to grade their relative proficiency. A scoring device conforming in size to the 50 and 75 percent shot groups to be expected of average shots firing at 1,000 inches, and at reduced ranges, can easily be made from wire, or a better one may be prepared by imprinting a scoring diagram on a sheet of transparent celluloid. The scoring space is outlined on the target in pencil before the target is shown to squad leaders. This procedure prevents any misunderstanding of squad leaders as to the limits of the designated target. Upon completion of firing, the entire squad is shown the target and the results of the firing.

(2) While shot groups are in the form of a vertical ellipse, the 50 and 75 percent zones should be shown by the devices as rectangles. This is for convenience in their preparation. For a distance of 1,000 inches the 50 percent zone is a rectangle 2½ inches high by 2 inches wide; the 75 percent rectangle is

5 inches high by 4 inches wide. For a distance of 50 feet the 50 percent zone is a rectangle  $1\frac{1}{2}$  inches high by 1.2 inches wide; the 75 percent rectangle is 3 inches high by 2.4 inches wide. The target is at the center of the inner rectangle or 50 percent zone.

(3) For a linear target, such as a small area over which the automatic-rifle man will distribute his fire, the 50 percent zone is formed by two parallel lines, drawn parallel to the longer axis of the target (area) and with the target midway between those lines. For a distance of 1,000 inches the lines should be  $2\frac{1}{2}$  inches apart; for a distance of 50 feet the lines should be  $1\frac{1}{2}$  inches apart. Two additional lines similarly drawn form the 75 percent zone. For a distance of 1,000 inches the lines should be 5 inches apart; for a distance of 50 feet the lines should be 3 inches apart. The width of the zones will vary according to the size of the target selected. For a distance of 1,000 inches the zones extend 1 inch beyond each end of the target; for a distance of 50 feet the zones extend 0.6 inch beyond each end of the target. The zones are then divided into a convenient number of equal parts, the number depending on the length (width) of the target and the number of men firing. This is done in order to give a score for distribution of shots fired on a linear target (see par. 120 b).

■ 118. ZEROING-IN OF RIFLES.—*a.* It will be necessary to zero-in the rifles used before firing exercises on the landscape target. A blank target with a row of ten 1-inch-square black pasters about 6 inches from and parallel with the bottom edge of the target should be prepared and used for this purpose. In all firing for zeroing-in, sandbag rests are used.

*b.* The procedure in detail is as follows:

(1) Sights of all rifles are blackened.

(2) The squad is deployed on the firing point; the squad leader takes the proper position in rear of the squad.

(3) The instructor causes each firer to set his sights at zero elevation and zero windage, or 100 yards and zero windage, and checks each rifle.

(4) Each man is assigned, as an aiming point, the particular small black paster which corresponds to his position in the squad.

(5) Rifles are loaded with three rounds only, at the command of the instructor.

(6) Each man fires three shots at his spotter at the command **THREE ROUNDS, FIRE AT WILL.**

(7) The instructor commands: **OPEN BOLTS.** The squad leader checks to see that this is done.

(8) The instructor and squad leader inspect the target and, based upon the location of the center of impact of the resultant shot group, give each man the necessary correction for his next shot as "Up 1 minute, right one-half point"; or for the service rifle "Up 25, left one point."

(9) The firing continues as outlined above until all rifles are zeroed in, that is, until each man has hit his aiming paster.

*c.* For the caliber .22 rifle with the Lyman receiver sight, at a distance of 1,000 inches, a change of 5 minutes in elevation will move the strike of the bullet about  $1\frac{1}{2}$  inches. A change of one point of windage moves the strike about  $1\frac{1}{4}$  inches. At a distance of 50 feet a change of 6 minutes in elevation will move the strike of the bullet about 1 inch, and a change of one point of windage, about  $\frac{3}{4}$  inch. For the caliber .30 rifle, at a distance of 1,000 inches, changes of 25 yards in elevation and one point of windage move the strike of the bullet about 1 inch in each direction. At a distance of 50 feet a change of 25 yards in elevation and one point of windage will move the strike of the bullet about  $\frac{3}{5}$  inch in each direction.

■ 119. **FIRING PROCEDURE.**—The sequence of events in conducting firing exercises is as follows:

*a.* All members of the squad, except the squad leader, face to the rear.

*b.* The instructor takes the squad leader to the panels and points out the target to him.

*c.* They return to the firing point; the squad leader takes charge of the squad and causes the men to resume their firing positions.

*d.* The squad leader gives the command **LOAD**, cautioning "— rounds per rifleman only."

*e.* The squad leader designates the target orally. Reference to panels to indicate direction should not be allowed

in the designation. To complete the fire order, the squad leader adds **FIRE AT WILL**.

*f.* When the squad has completed firing, the squad leader commands: **CEASE FIRING, OPEN BOLTS**. The squad then examines the target. The target panel is removed, scored, marked with the squad number, and replaced with a new panel.

*g.* The instructor holds a short critique after each exercise.

■ **120. SCORING.**—*a. Concentrated fire.*—In concentrated fire the sum of the value of the hits within the two zones is the score for the exercise. For convenience of scoring and comparison, 100 is fixed as the maximum score. Any method of scoring and of distribution of ammunition among members of the squad may be used. The following examples are given as suggested methods:

- (1) Number of rounds fired, 50.
- (2) Value of each hit in 50 percent zone, 2.
- (3) Value of each hit in 75 percent zone, 1.

*b. Distributed fire.*—A method of scoring for distributed fire, such as the fire of the squad on a target of width, is as follows:

- (1) Number of rounds fired, 50.
- (2) Value of each hit in 50 percent zone, 2.
- (3) Value of each hit in 75 percent zone, 1.
- (4) Value of each distribution space (if target is divided into 10 equal spaces), 10.
- (5) The score for distribution, plus the value of all hits, divided by two is the score for the exercise.

■ **121. EXERCISES.**—*a. No. 1.*—(1) *Purpose.*—To teach target designation and to show the effect of concentrated fire.

(2) *Method.*—The squad leader employs the fire of his squad at one point-target indicated to him by the instructor.

*b. No. 2.*—(1) *Purpose.*—To teach target designation and the division of the squad fire on three points of concentration.

(2) *Method.*—The instructor indicates three point-targets to the squad leader, giving the nature of each. The squad leader applies the fire of his squad on the three targets in the proportions directed by the instructor. The scoring

will be as for concentrated fire on each target, the several scores being combined in totals for the score of the exercise.

*c. No. 3.*—(1) *Purpose.*—To teach target designation and fire control in diverting part of the fire of the squad to a suddenly appearing target.

(2) *Method.*—The instructor indicates a point-target to the squad leader. After firing has commenced, the instructor indicates and gives the nature of a new target to a flank. The squad leader applies the fire of his squad to the first target. When the second target is indicated, he shifts the fire of the number of riflemen, as directed by the instructor, from the first to the second target.

*d. No. 4.*—(1) *Purpose.*—To teach the application of fire on an enemy group marching in formation, the fire control necessary to obtain fire for surprise effect, and to show the effect of fire on troops in formation.

(2) *Method.*—The instructor indicates to the squad leader a target that represents a small group of the enemy marching in approach march formation, formation for patrol, or the like; the enemy not being aware of the presence of the squad. The squad leader applies the fire of his squad; his instructions must result in the simultaneous opening of fire of all weapons and the distribution of fire over the entire target. The assignment of the five riflemen on the right to fire at the rear half of the target, and the remaining riflemen at the forward half, is a satisfactory method of distributing fire over such target.

*e.* The second-in-command of the squad will be given instruction and practice in the same type of exercises as outlined above.

## SECTION VII

### FIELD-TARGET FIRING

■ 122. *PURPOSE.*—The purpose of this phase of training is to instruct leaders further in the control of their units under simulated battle conditions, and the soldier in the performance of his duties as a member of a fighting team so as to secure the maximum fire efficiency.

■ 123. *SCOPE.*—The training in this phase is similar to that given the soldier in landscape-target firing, but with the



added features of the use of cover, range estimation, firing the rifle with ball ammunition at field targets at unknown ranges, and fire control under more difficult conditions. Training must be progressive with the soldier, an opportunity being afforded first to fire at more or less exposed targets, followed by fire at targets which are concealed from view but exposed to fire. Individuals should preferably receive this training in the squad or in smaller groups.

■ 124. **TERRAIN.**—*a.* The availability of ground and considerations for safety determine the selection of terrain for combat ranges. Where possible, varied ground suitable for the employment of all weapons of the rifle unit will be selected. It is a great advantage from the instructional standpoint to use ground that is unfamiliar to the unit to be trained.

*b.* In the absence of other facilities the known-distance ranges can be used by arranging the exercises so that they will begin off the range and require the delivery of fire on the range and in a safe direction.

■ 125. **TARGETS.**—*a.* Targets may be improvised from available material or they may be obtained from the Ordnance Department.

*b.* With the field targets furnished by the Ordnance Department a stationary target may be represented by E or F targets placed on staves and driven in the ground.

*c.* A surprise target that can appear and disappear may be made by using either E or F targets fastened to an I-beam and operated by a man in a pit.

*d.* A movable field target may be made by fastening E or F targets to a sled. (See fig. 50.)

*e.* In the field, targets should be placed in locations that would be used by an intelligent enemy. They should not be prominently exposed nor in a regular line. The exposure of targets kept out of sight at the beginning of an exercise may be indicated by the firing of blank ammunition or the operation of other noise or smoke-producing equipment in the vicinity of the target when it does appear. In platoon problems, targets may be placed so as to be visible with field glasses but entirely invisible to the naked eye, so that skill is necessary in designating the target and adjusting the fire.

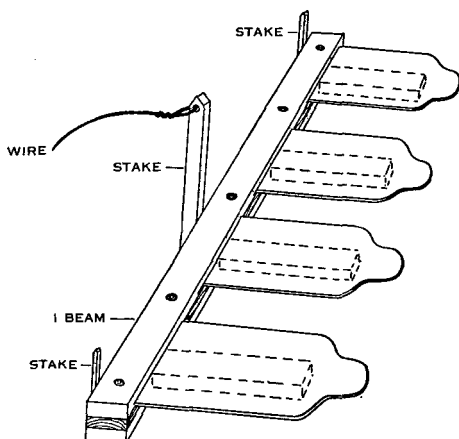
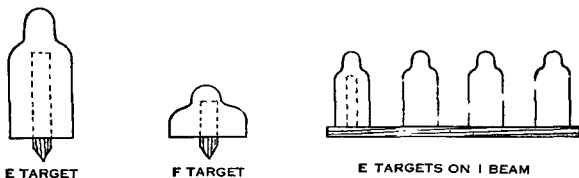

ARRANGEMENT FOR SURPRISE TARGET

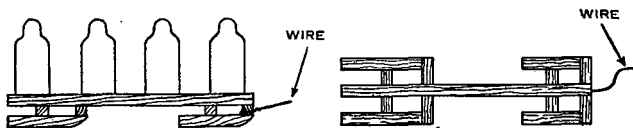

E TARGETS ON SLED

TOP VIEW OF SLED

FIGURE 50.—Field targets.

f. The appearance of the targets from the firing line will depend a great deal upon the direction of the sun, the background of the targets, and the angle at which the targets are placed. These factors should be taken into consideration when placing the targets for any particular exercise.

■ 126. SHELTER.—Ranges for combat firing exercises can be efficiently operated without an elaborate system of shelters and dugouts. Simple pits to accommodate the target operators are sufficient. Every effort should be made to avoid altering the natural appearance of the terrain when locating and constructing pits. When targets are placed in the rear of or to one side of the pits, the likelihood of ricochets falling into the pit is minimized.

■ 127. SAFETY.—a. In general the safety precautions used at known-distance ranges apply with equal force to instruction in firing at any field target (see AR 750-10). Safety of personnel is of primary importance in conducting exercises which require the firing of ball ammunition. To this end exercises should be drawn to conform to the state of training of the units concerned.

b. The officer in charge of an exercise is responsible for the safety of the firing; it is his duty to initiate and enforce such precautions as he deems necessary under existing conditions. No other officer can modify his instructions without assuming the responsibility for the safety of the firing.

c. While firing, no man should be permitted to be ahead of or in rear of the firing line a distance greater than one-half the interval between himself and the man next to him. For example, if the interval between skirmishers is ten paces, then no man should be more than five paces ahead of or behind the man next to him on either side.

d. Firing will not start until it has been ascertained that the range is clear, pit details are not exposed, and *all safety precautions complied with*. Once ammunition has been issued no man is permitted to move to another firing point. Upon completion of firing, the officer in charge will cause all rifles and belts to be unloaded and inspected, and all ammunition collected so that none remains in the possession of the men returning to camp or barracks.

e. During the firing of exercises, rifles will be pointed in the direction of the target at all times. Special vigilance is required to enforce this rule while men are using a cleaning rod to remove any obstruction from the chamber.

■ 128. GENERAL CONSIDERATIONS.—*a. Progressive training.*—The inclusion of the training in moving from an approach march formation or place of concealment to firing positions is, primarily, to teach the soldier the proper use of cover and selection of firing positions, and to combine the technique of applying and controlling collective fire with scouting and patrolling and other prerequisite allied subjects.

*b. Firing positions and representation of enemy.*—In battle, a unit is not deployed with individuals abreast and at regular intervals apart. The selection of individual and group positions is governed by the field of fire, cover or concealment while firing, cover of approach to those positions, fire control, and nature of target. The representation of the enemy will conform to irregular battle formations.

*c. Use of cover.*—(1) The use of available cover is important for two reasons. The man who neglects the use of cover will be seen and hit. His squad not only loses the fire effect of one rifle, but its position is unnecessarily disclosed and other casualties may follow.

(2) The individual use of cover and concealment is taught in scouting and patrolling. In training in firing at field targets the principles are the same.

(3) In seeking cover in a firing position men may move a few yards in any direction, but they must not be allowed to bunch together behind concealment which does not afford protection from fire. They avoid positions which will mask the fire of others or cause their own fire to be dangerous to other men of their unit.

*d. Marksmanship applied.*—(1) The principles of rifle marksmanship are followed in this training insofar as they fit the conditions.

(2) These principles should be applied to the technique of fire and to combat in a common-sense way. It should be appreciated that the conditions encountered in combat situations will differ from those found on the target range. On

the target range the soldier is expressly prohibited from resting his rifle against an unauthorized rest while firing. In this phase of training and in battle the soldier takes advantage of trees, rocks, or any other rest which will make his fire more accurate. The positions prescribed in rifle marksmanship are used whenever the ground will permit, but on rough ground it is often necessary to modify them in order to get a comfortable and steady position. The loop sling is preferable except—

(a) In the standing position.

(b) When the situation requires readiness for immediate use of the bayonet.

(c) In emergencies demanding immediate fire without time for adjustment of the loop sling.

*e. Use of the battle sight.*—The battle sight corresponds to a sight setting of 547 yards. It is less accurate than the peep sight and is used only when time is lacking for setting the peep sight or in firing at aircraft or other moving targets. By keeping the peep sight habitually set at 300 yards when not in use, the soldier has two sights ready for emergencies.

## SECTION VIII

### FIRE EXERCISES

■ 129. GENERAL.—*a.* Exercises for firing at field targets should be suitable to the actual terrain upon which they are conducted. These exercises will include one or more problems fired with the gas mask adjusted.

*b.* Each exercise should be initiated by a unit either—

(1) Already deployed in a firing position;

(2) Halted in approach march formation or in a place of concealment with scouts present in formation, the unit either acting alone or as part of a larger force; or

(3) Advancing in approach march formation, with scouts out.

*c.* (1) In the first case (*b* (1) above) each man should be in a selected firing position, special attention being paid to individual cover and concealment.

(2) In the second case (*b* (2) above) squad leaders conduct their squads forward by covered routes and send the

riflemen to their firing positions by individual directions. Occupation of the initial firing position of a unit is done with the minimum of exposure.

(3) In the third case (*b* (3) above) the scouts must be checked by an assumed enemy fire when they are at a suitable location for a firing position of the squad; otherwise, if they are permitted to advance beyond this position, they must be withdrawn from the exercise before firing is begun by the squad.

■ 130. CRITIQUE.—At the completion of the firing of any exercise the instructor should conduct a critique of that exercise with the firing unit. A suggested form for such a critique is as follows:

- a.* Purpose of the exercise.
- b.* Orders of squad leader.
- c.* Approach and occupation of the firing position (individual concealment and cover).
- d.* Action of individuals.
- e.* Rate of fire.
- f.* Fire control.
- g.* Effect of the fire (upon completion of firing, the range being clear, the targets are scored).
- h.* Performance of the unit—satisfactory or unsatisfactory.

■ 131. SUGGESTED EXERCISES.—*a. No. 1.*—(1) *Purpose.*—Practice in fire orders, application of the fire of a squad in position, fire control, proper individual concealment in the occupation of the firing position.

(2) *Method.*—Enemy represented by one group of targets exposed to fire but partially concealed from view, requiring a simple fire order. Squad leader is shown the targets (personnel with flag) and safety limits for firing position of the squad. When the squad leader fully understands the location and nature of the target and the instructor informs him that the range is clear, he will load ball ammunition, give the fire order, and fire the problem. The range should be estimated by eye and the target designated by oral description.

*b. No. 2.*—(1) *Purpose.*—Practice in fire orders, application of the fire of a rifle squad on a linear target, fire control,

proper deployment and individual concealment in the occupation of the firing position, engagement of a surprise target.

(2) *Method*.—Silhouette targets, representing an enemy squad deployed in a firing position, are partially concealed from view but exposed to fire. A screen behind the targets is marked with distribution spaces to give squad credit for the shots that did not hit the targets but which would have had an effect on an enemy. Squad is in rear of the firing position; squad leader (scouts) being shown the linear target (by flag) then conducts squad forward and disposes it in a concealed firing position. When squad leader is told the range is clear he will engage the target with surprise fire. A surprise target, well to the flank of the first target, representing an enemy machine gun, appears shortly after the squad has engaged the linear target. The squad leader is told the amount of fire to shift to the surprise target. In addition to the suggested form of critique in paragraph 130, proper distribution of the fire of a rifle squad on a linear target and the engagement of the surprise target should be discussed.

*c. No. 3.*—(1) *Purpose*.—Practice in target designation by scouts with tracer ammunition and in teaching how to approach and assume a firing position for a squad.

(2) *Method*.—The squad is marching in approach march formation with both scouts well in advance. When the scouts reach the firing position they observe the targets representing an enemy group about 400 yards to their front. They determine the range by firing on the target with tracer bullets. The squad leader conducts his squad forward, establishes the men in firing positions, and engages the targets with the proper class of fire, after the targets have been designated by the scouts by the use of tracers. Special attention is paid to the use of cover and concealment by all men while moving up and during the selection and occupation of positions.

*d. No. 4.*—(1) *Purpose*.—Practice in firing at moving targets.

(2) *Method*.—Riflemen fire individually at targets carried on long sticks by men in the pits of a class A range. The men in the pits are each assigned a space, the width of about

five regular range-target spaces, in which they walk continuously back and forth. By whistle signal, targets are exposed to the firing line for 5 seconds and then concealed for 5 seconds. Targets are exposed once for each shot to be fired. On the firing line one man is assigned to each target. Ranges of 200 or 300 yards are best suited for this class of firing.



## CHAPTER 6

### ADVICE TO INSTRUCTORS

	Paragraphs
SECTION I. General.....	132
II. Mechanical training.....	133
III. M a r k s m a n s h i p—known-distance targets.....	134-148
IV. Marksmanship—air targets.....	149-153
V. Technique of fire.....	154-160

#### SECTION I

##### GENERAL

■ 132. **PURPOSE.**—The provisions of this chapter are to be accepted as a guide and will not be considered as having the force of regulations. They are particularly applicable to emergency conditions when large bodies of troops are being trained under officers and noncommissioned officers who are not thoroughly familiar with approved training methods.

#### SECTION II

##### MECHANICAL TRAINING

■ 133. **CONDUCT OF TRAINING.**—*a.* As a general rule instruction is so conducted as to insure the uniform progress of the platoon and company.

*b.* The instructor briefly explains the subject to be taken up and demonstrates it himself or with a trained assistant.

*c.* The instructor then causes one man in each squad or subgroup to perform the step while he again explains it.

*d.* The instructor next causes all members of the squads or subgroups to perform the step, checked by their noncommissioned officers. This is continued until all men are proficient in the particular operation, or until those whose progress is slow have been placed under special instructors.

*e.* Subsequent steps are taken up in like manner during the instruction period.

## SECTION III

## MARKSMANSHIP—KNOWN-DISTANCE TARGETS

■ 134. GENERAL.—Training is preferably organized and conducted as outlined in paragraphs 23 and 24. Officers should generally be considered as the instructors of their units. As only one step is taken up at a time, and as each step begins with a lecture and a demonstration showing exactly what to do, the trainees, although not previously instructed, can carry on the work under the supervision of the instructor.

■ 135. PLACE OF ASSEMBLY FOR LECTURES.—Any small ravine or cup-shaped area makes a good amphitheater for giving the lecture in case no suitable building is available.

■ 136. ASSISTANT INSTRUCTORS.—*a.* It is advantageous to have all officers and as many noncommissioned officers as possible trained in advance in the prescribed methods of instruction. When units are undergoing marksmanship training for the first time, this is not always practicable nor is it absolutely necessary. A good instructor can give a clear idea of how to carry on the work in his lecture and demonstration preceding each step. In the supervision of the work following the demonstration, he can correct any mistaken ideas or misinterpretations.

*b.* When an officer in charge of rifle instruction (see par. 24 *d*) is conducting successive organizations through target practice, it is advisable to attach to the first organization taking the course officers and noncommissioned officers of the companies that are to follow for the period of preparatory work and for a few days of range firing. These act as assistant instructors when their own companies take up the work. Such assistants are particularly useful when one group is firing on the range and another is going through the preparatory exercises, both under the supervision of one instructor.

■ 137. EQUIPMENT.—The instructor should personally inspect the equipment for the preparatory exercises before the training begins. A set of model equipment should be prepared in advance by the instructor for the information and guidance of

the organization about to take up the preparatory work. The sighting bars must be made as described, and the hole representing the peep sight must be absolutely circular. If the sights are made of tin, the holes should be bored by a drill. Good rear sights can be made for the sighting bars by using cardboard and cutting the holes with a punch for cutting wads for 10-gage shotgun shells. Bull's-eyes painted on a white disk are not satisfactory. Bull's-eyes cut out of black paper with a shotgun-wad cutter and pasted on white paper make satisfactory aiming points either to paste on the face of the disk or to use in position and trigger-squeeze exercises, when small gallery targets are not available for this purpose.

■ 138. INSPECTION OF RIFLES.—No man is required to fire with an unserviceable or inaccurate rifle. All rifles should be carefully inspected far enough in advance of the period of training to permit organization commanders to replace all inaccurate or defective rifles. Rifles having badly pitted barrels are not accurate and should not be used.

■ 139. AMMUNITION.—The best ammunition available should be reserved for record firing and the men should have a chance to learn their sight settings with that ammunition before record practice begins. Ammunition of different makes and of different lots should not be used indiscriminately.

■ 140. ORGANIZATION OF THE WORK.—*a. In preparatory training.*—(1) The field upon which the preparatory work is to be given should be selected in advance and a section of it assigned to each organization. The equipment and apparatus for the work should be on the ground and in place before the morning lecture is given, so that each organization can move to its place and begin work immediately and without confusion.

(2) Each company should be organized in two lines, facing away from each other. In this way the company officers and other instructors, whose position is normally between the lines, have all of their squads under close supervision. In figure 51 the groups represented consist of 8 men each.

(3) The arrangement of the equipment is as follows:

(a) On each line are placed the sighting bars and rifle rests at sufficient intervals to permit efficient work.

(b) Fifty feet from each line is placed a line of small boxes with blank paper tacked on one side, one box and one small sighting disk to each rifle rest.

(c) Two hundred yards from each line is placed a line of frames suitable for 200-yard shot group exercises, one frame

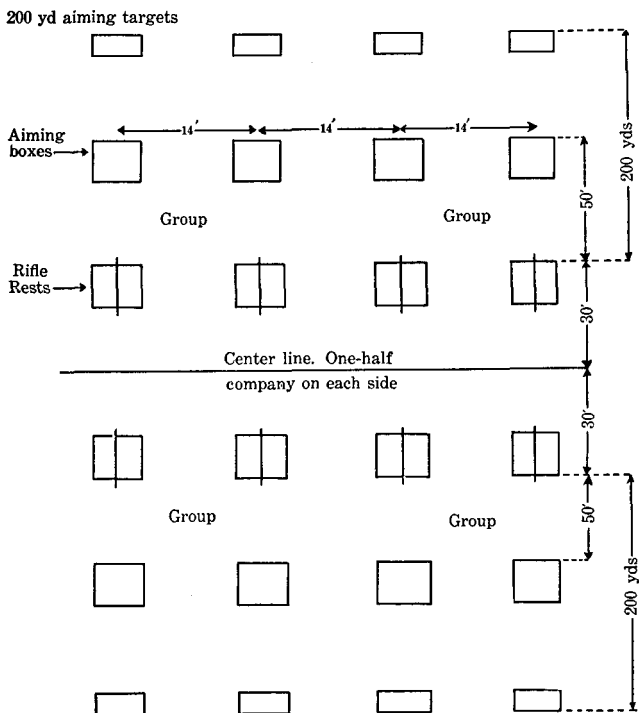

FIGURE 51.—Portion of field laid out for sighting and aiming exercises.

to each squad. These frames have blank paper tacked or pasted on the front. A 10-inch sighting disk is placed with each frame. Machine-gun targets make acceptable frames for this work.

(4) In position, trigger-squeeze, and rapid-fire exercises targets should be placed at 1,000 inches and 200 yards. The groups represented in figure 52 consist of 8 men each.

(5) When sufficient level ground is not available for the above arrangement the organizations will have to vary from it in some particulars. It will nearly always be found, however, that all of the work except the long-range shot group work can be carried on in two lines.

*b. In range practice.*—(1) The range work should be so organized that there is a minimum of lost time on the part of each man. Long periods of inactivity while awaiting a

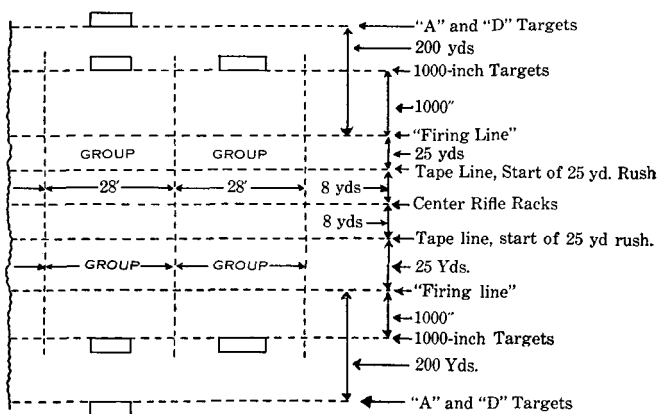

FIGURE 52.—Portion of field laid out for position, trigger-squeeze, and rapid-fire exercises.

turn on the firing line should be avoided. For this purpose no more men should be on the range at one time than the number of targets available can accommodate efficiently.

(2) As a general rule six men per target is about the maximum and four men per target the minimum for efficient handling.

(3) In rapid fire it is advisable to have on the line the order that is next to fire and to have them practice with dummy ammunition or simulated fire. When the size of the firing point makes this action impracticable, each order

should be given a score of simulated fire before firing with ball cartridges.

(4) Subject to ammunition allowances the following method of carrying on range practice has been found to produce uniformly excellent results when the full allowance of time is devoted to the training:

(a) Organizations camp on the range (if it is more than a mile from the post).

(b) Firing is begun by a group consisting of approximately half of each organization. This group is made up of those proved to be the best by the examination on preparatory work and those known to be good shots. Under ordinary circumstances an allowance of from four to six men per target would result. The men who are not included in this first group make up all the pit details and undergo additional preparatory training, particularly in rapid fire.

(c) After about 30 hours' instruction practice all of the first group, except those few who have not been shooting well, fire for record.

(d) The second group, made up of those who have not fired and those who were rejected from the first group, now begins firing. The men who have completed record firing perform all fatigue.

(e) After about 30 hours' instruction practice all of this second group, who have been shooting well and have a very good chance to qualify, fire for record.

(f) During the remainder of the allotted time the efforts of the officers and noncommissioned officers are concentrated on the men who were not ready to fire for record with the second group. This last group fires for record by the end of the allotted time for range practice.

(5) When range facilities are such that the entire organization can fire at one time without having more than four or at the most six men per target, the same general scheme as that outlined above may be applied as follows:

(a) Firing is begun with all of the men of the organization taking part.

(b) After about 30 hours' instruction practice, all except those who have not been shooting well, fire for record.

(c) The efforts of the instructors are concentrated on the remnant of the organization for the rest of the allotted time.

■ 141. MODEL SCHEDULES.—*a. Course A.*—The following schedule of preparatory exercises is suggested as a guide for a 3 weeks' course. The practice firing ((2) below) is based upon a maximum of six men per target.

(1) *Lecture and demonstration.*

	MONDAY	
	Hours	
	A. M.	P. M.
FIRST STEP.....	1	
First, second, and third sighting exercises.....	3	
Continuation of first three exercises, including long-range shot group exercise.....		2
Care and cleaning of the rifle; safety precautions..		1

TUESDAY		
SECOND STEP.....	1	
Position exercise in all positions.....	3	
THIRD STEP.....		1
Trigger-squeeze exercise using sandbag rest, fol- lowed by exercises in all positions.....		3

WEDNESDAY		
FOURTH STEP.....	1	
Bolt-operation exercise.....	2	1
Exercises in taking position rapidly.....	1	
Rapid-fire exercises.....		3

THURSDAY		
FIFTH STEP.....	1	
Score-book exercise.....	2	
Review trigger-squeeze exercise in all positions..	1	
Rapid-fire exercises.....		2
Final examination.....		2

(2) *Practice firing.*

FRIDAY		Hours
Table I (simulated).....		2
Table I.....		5

SATURDAY		<i>Hours</i>
Table II (simulated) .....		2
Table II .....		3
MONDAY		
Tables III and IV, 200 yards (simulated) .....		1
Tables III and IV, 200 yards .....		3
Tables III and IV, 300 yards (simulated) .....		1
Tables III and IV, 300 yards .....		3
TUESDAY		
Tables III and IV, 500 yards (simulated) .....		1
Tables III and IV, 500 yards .....		3
Table V (simulated) .....		1
Table V .....		3
WEDNESDAY		
Table VI, 200 yards (simulated) .....		1
Table VI, 200 yards .....		1
Table VI, 300 yards (simulated) .....		1
Table VI, 300 yards .....		1
THURSDAY		
Table VII, 200 yards (simulated) .....		1
Table VII, 200 yards .....		1
Table VII, 300 yards (simulated) .....		1
Table VII, 300 yards .....		1
Table VIII .....		4
FRIDAY		
Table IX .....		2
Table X .....		2

*b. Courses B, C, and D.*—The preparatory exercises and 1,000-inch firing are the same as course A. All other firing is conducted in a manner similar to course A reducing the time accordingly.

■ 142. LECTURES AND DEMONSTRATIONS.—*a.* The lectures at the beginning of each step are an important part of the instructional methods. The lectures may be given to the



assembled command or group undergoing preparatory rifle training up to and including a regiment or body of recruits of similar size. However, when a battalion takes up rifle training the talks and demonstrations as a rule are made by the captain or a lieutenant of each company. It is not necessary that they be expert shots.

b. The notes on lectures which follow are to be used merely as a guide. The points which experience has shown to be the ones which usually require elucidation and demonstration are placed in italic side headings. The notes which follow each heading are merely to assist the instructor in preparing his lecture. The lecturer should know in advance what he is going to say on the subject. Under no circumstances will he read over to a class the outlines for lectures contained herein nor will he read a lecture prepared by himself. During the lecture the subjects in italics serve as a guide as to the order in which they are to be discussed. If the instructor cannot talk interestingly and instructively on each subject without further reference to notes, he should not be giving the lectures at all.

c. The one important thing is to show the men undergoing instruction, by explanation and demonstration, just how to go through the exercises and to impress upon them why they are given.

■ 143. FIRST LECTURE: SIGHTING AND AIMING.—*a.* The class is assembled in a building or natural amphitheater in the open where all can hear the instructor and see the demonstrations.

*b.* The following equipment is necessary for the demonstrations:

- (1) One sighting bar.
- (2) One rifle rest.
- (3) One rifle.
- (4) One small sighting disk.
- (5) One 10-inch sighting disk.
- (6) One small box.
- (7) Material for blackening sights.

*c.* The following subjects are the ones usually discussed in the first lecture:

(1) *Value of knowing how to shoot.*—(a) The rifle is the principal weapon of the Infantry in war. Expertness in its use gives the individual confidence and a higher morale.

(b) Individual proficiency increases the efficiency of Infantry as a whole.

(c) Rifle firing is good sport.

(2) *Object of target practice.*—(a) To teach men how to shoot.

(b) To show them how to teach others.

(c) To train future instructors.

(3) *Training to shoot well.*—(a) Any man can be taught to shoot well. Shooting is a purely mechanical operation which can be taught to anyone physically fit to be a soldier.

(b) It requires no inborn talent such as to play a violin or paint a picture.

(c) There are only a few simple things to do to shoot well, but these things must be done in a manner exactly right. If they are done in a manner only approximately right, the results will be poor.

(4) *Method of instruction.*—(a) The method of instruction is the same as in teaching any mechanical operation.

(b) The instruction is divided into steps. The man is taught each step and practices it before going to the next step. When he has been taught all of the steps he is taken to the rifle range to apply what he has learned.

(c) If he has been properly taught the various preparatory steps, he will do good shooting from the very beginning of range practice.

(d) Explain coach-and-pupil method. Why used.

(5) *Reflecting attitude of instructor.*—If the instructor is interested, enthusiastic, and energetic, the men will be the same. If the instructor (squad, section, or platoon leader) is inattentive, careless, and bored, the men will be the same and the scores will be low.

(6) *Examination of men on preparatory work.*—Each man is examined in the preparatory work before going to the range. An outline of this examination is given in paragraph 31. The questions and answers in this paragraph are of material assistance while going through the exercises of each step.

(7) *Method of marking blank form.*—Explain blank form, paragraph 24 f (2). Explain marking system by the use of a blackboard, if available.

(8) *Five essentials to good shooting.*—(a) Correct sighting and aiming.

(b) Correct position.

(c) Correct trigger squeeze.

(d) Correct application of rapid-fire principles.

(e) Knowledge of proper sight adjustments.

(9) *Today's work.*—First step, sighting and aiming.

(10) *Demonstration of first sighting-and-aiming exercise.*—Have a squad on stage or platform and show just how this exercise is carried on.

(11) *Blackening the sights.*—Explain why and demonstrate how this is done.

(12) *Demonstration of second sighting-and-aiming exercise.*—Assume that some of the squad have qualified in the first exercise. Put these men through the second sighting-and-aiming exercise and show just how it is done.

(13) *Demonstration of third sighting-and-aiming exercise.*—(a) Assume that some of the squad have qualified in the second sighting-and-aiming exercise. Put these men through the third sighting-and-aiming exercise and show just how it is done.

(b) Show how the squad is organized by the coach-and-pupil method so as to keep each man busy all the time.

(14) *Long-range shot group work.*—Show the class the disk for 200-yard shot group work. Explain how this work is carried on and why. Show some simple system of signals that may be used.

(15) *Final word.*—(a) Start keeping your blank form today.

(b) Organize your work so that all men are busy at all times.

(16) Are there any questions?

(17) Next lecture will be tomorrow or----- (State hour and place.)

■ 144. SECOND LECTURE: POSITIONS.—a. The following equipment is necessary for the demonstrations in this lecture:

(1) One rifle with sling.

- (2) One sandbag.
- (3) One box with small aiming target.
- (4) One aiming device.

b. The following subjects are the ones usually discussed in the second lecture:

(1) *Importance of each step.*—(a) Each step includes all that has preceded.

(b) Each step must be thoroughly learned and practiced or the instruction will not be a success.

(2) *Necessity for correct positions.*—No excellent shot varies from the normal positions. Few men with poor positions are even fair shots. Few men with good positions are poor shots. Instruction in positions involves correct aiming.

(3) *Gun sling.*—Demonstrate both of the gun-sling adjustments and explain why they are used, and when each is used.

(4) *Taking up the slack.*—Show the class the slack on the trigger. Explain why it is taken up in the position exercises. (Cannot begin to squeeze the trigger until the slack has been taken up.)

(5) *Holding the breath.*—Explain the correct manner of holding the breath and have the class practice it a few times. Explain how the coach observes the pupils' breathing by watching their backs.

(6) *Aiming device.*—Show how it is placed on the rifle and how it is used.

(7) *Position of the thumb.*—May be either over the stock or along the side of the stock. Explain why.

(8) *Joint of the finger.*—Trigger may be pressed with first or second joint. Second joint preferable when it can be done conveniently.

(9) *Prone position.*—(a) Demonstrate correct prone position, calling attention to the elements which go to make up a correct prone position—gun sling properly adjusted, body at the correct angle, legs spread well apart, position of the butt on the shoulder, position of the hands on the rifle, position of cheek against the stock, position of elbows.

(b) Mention the usual faults which occur in prone position.

(c) Demonstrate the correct position again.

(10) *Sandbag rest position*.—(a) Demonstrate in the same manner as described above for prone position.

(b) Demonstrate coach adjusting sandbag to the pupil.

(11) *Sitting position*.—Demonstrate in the same manner as described above for the prone position.

(12) *Kneeling position*.—Demonstrate in the same manner as described above for the prone position.

(13) *Standing position*.—Demonstrate in the same manner as described above for the prone position.

(14) *Today's work; position exercises*.—(a) Demonstrate the duties of a coach in a position exercise, calling attention to each item.

(b) Demonstrate the position of the coach. Always placed so that he can watch the pupil's finger and eye.

(c) Place a squad on an elevated platform and show how the squad leader organizes it by employing the coach-and-pupil method, so as to keep every man occupied.

(d) Continue the long-range triangle work today.

(15) *Do not squeeze the trigger today*.—Take up the slack in these exercises but do not squeeze the trigger.

(16) *Keep the blank forms up to date*.—Examine each man in the squad at the end of the day's work and assign him a mark.

(17) Are there any questions?

(18) Next lecture will be tomorrow or ----- (State hour and place.)

■ 145. THIRD LECTURE: TRIGGER SQUEEZE.—a. The following equipment is necessary for the demonstrations:

(1) One rifle with sling.

(2) One aiming device.

(3) One sandbag.

(4) One box with small aiming target.

b. The following subjects are the ones usually discussed in the third lecture:

(1) *Trigger squeeze most important*.—Read paragraph 28.

(2) *Sandbag rest*.—Explain why it is used in trigger-squeeze exercise.

(3) *Machine rest example*.—Lay the rifle on the table, pointing down the room and toward an imaginary target;

assume that it is in a machine rest which runs on a track parallel to the line of targets; assume that you fire a shot which hits the left edge of a 36-inch bull's-eye 1,000 yards away; then move the rifle 36 inches to the right on the table as if it were sliding along the parallel track and assume that another shot is fired. Where does it hit? Answer: The right edge of the bull's-eye. Move the rifle backward and forward between these two positions and assume a shot is fired any time while it is moving. Where will it hit? Answer: In the bull's-eye. Now assume that you hold the butt of the rifle still and move the muzzle a fraction of an inch. Where will it hit? Answer: It will miss the whole target. It hits the target when the whole rifle moves, but misses it when only one end moves.

(4) *Pulsations of body.*—The natural movements of the body and its pulsations produce more or less parallel movement of the rifle. Very often men who are apparently very unsteady make good scores. You thus see that if you squeeze the trigger so as not to know when the rifle will go off, the shot is displaced only by the amount of the parallel movement and will be a good one. But if you give the trigger a sudden pull, or flinch, you deflect one end of the rifle, and the shot will be a poor one.

(5) *Aim and hold.*—If he is physically fit to be a soldier any man can easily learn to hold a good aim for quite a long time—15 to 20 seconds at least. Poor shots are the men who spoil this aim when they fire the rifles.

(6) *Coach squeezing the trigger.*—(a) The fact that when the coach squeezes the trigger for the firer the shot is almost invariably a good one proves that poor shooting is principally due to errors in the trigger squeeze.

(b) It is not necessary for the coach to watch the sights through the aiming device. By watching the firer's back he knows when the firer is aiming and then presses steadily on the trigger. Demonstrate how it is done.

(7) *Flinchers.*—Flinching is an instinctive and subconscious act which no man can control. Any man who gives the trigger a sudden pressure will flinch. Excellent shots are the men who avoid this flinching by pressing the trigger in such a way as not to know when the discharge will take place.

(8) *When the rifle goes off before the man is ready.*—Often a man who has been doing poor shooting will state upon firing a shot, "I cannot call that shot. It went off before I was ready." Almost invariably these shots are well placed. His poor shooting has been caused by *getting ready* for them.

(9) *Calling the shot.*—Explain calling the shot and why it is done.

(10) *Today's work; trigger-squeeze exercise.*—(a) Demonstrate the duties of a coach in a trigger-squeeze exercise by calling attention to each item.

(b) The work is carried on as in position exercises, with the squeezing of the trigger added.

(c) Practice in the prone position only this morning, first with, then without, the sandbag.

(d) Finish up the long-range shot group work today.

(11) *Keep the blank forms up to date.*—Examine each man in the squad at the end of the day's work and assign him a mark.

(12) *Final word.*—Do not let yourselves become bored with this work. It is easy to learn, but it takes a lot of practice to train the muscles and to get in the habit of doing the right thing without thinking.

(13) Are there any questions?

(14) Next lecture will be tomorrow or ----- (State hour and place.)

■ 146. FOURTH LECTURE: RAPID FIRE.—a. The following equipment is necessary for the demonstrations:

(1) One rifle with gun sling.

(2) Two clips of practice dummy cartridges.

(3) A short piece of cord.

b. The following subjects are the ones usually discussed in the fourth lecture:

(1) *Rapid fire true test of good shot.*—Superiority of fire in battle depends on the ability to deliver rapid and accurate fire.

(2) *Fire to be accurate.*—(a) Fire that is rapid without being accurate is of no value.

(b) Trigger squeezed the same as in slow fire.

(3) *Meaning of rapid fire.*—Rapid fire is merely continuous fire. The rapidity comes from working the bolt quickly, re-

loading the clips into the magazine smoothly, and keeping the eye on the target while operating the bolt.

(4) *Keeping the eye on the target.*—(a) Explain the advantages of this and how it gains time.

(b) Demonstrate the correct way to operate the bolt and the way a man does it who looks into the magazine each time.

(5) *Application in war.*—Explain the advantage of keeping the eye on the target in war.

(6) *Bolt-operation exercise.*—(a) Show how the trigger is tied back to the trigger guard and explain why.

(b) Demonstrate the exercise.

(7) *Operating the bolt in rapid fire.*—Show how it is done in the prone position and in the sitting positions, calling attention to the details in each case. (Trigger not tied in this demonstration.)

(8) *Necessity for great amount of rapid-fire practice.*—(a) A smooth and rapid bolt operation on the part of a soldier materially increases his rapid-fire scores and his efficiency in battle.

(b) Practice in loading clips of cartridges into the magazine also necessary.

(9) *Assuming positions rapidly.*—(a) The prone position can be assumed and an aimed shot fired more rapidly than from any other position.

(b) Application in war.

(c) Demonstrate, first by the numbers and then as one smooth movement.

(d) Even if it takes a few seconds longer, get into the correct position before starting to shoot.

(10) *Today's work; rapid-fire exercise.*—(a) Explain how exercises are to be carried on.

(b) Demonstrate the duties of a coach in a rapid-fire exercise, calling attention to each item.

(c) First period today will be devoted to the bolt-operation exercise and it will be repeated in short periods from time to time until each man qualifies.

(d) Practice will also be had in taking positions rapidly.



(11) *Keep the blank forms up to date.*—Examine each man in the squad at the end of the day's work and assign him a mark.

(12) Are there any questions?

(13) Next lecture will be tomorrow or ----- (State hour and place.)

■ 147. FIFTH LECTURE: EFFECT OF WIND AND LIGHT; SIGHT CHANGES; SCORE BOOK.—*a.* This part of the preparatory instruction can be given on any day in which the weather forces the work to be done indoors. If no bad weather occurs, this work should follow rapid-fire instruction.

*b.* The following equipment is necessary for the demonstrations:

(1) One A, B, and D target for each range at which each of these targets is to be used in range practice. These targets to be mounted on frames and marked with the proper windage and elevation lines.

(2) Ten spotters that can readily be stuck into the targets.

(3) Each man to have his rifle and a score book.

*c.* The following subjects are the ones usually discussed in the fifth lecture:

(1) *Targets.*—(*a*) Explain the divisions on the targets and give the dimensions of each.

(*b*) Call attention to windage and elevation lines. Have class compare them with diagram in the score book. Explain why lines are farther apart as the range increases.

(2) *Weather conditions.*—All weather conditions disregarded except wind.

(3) *Wind.*—(*a*) Explain how the direction of the wind is described.

(*b*) Explain how the velocity of the wind is estimated.

(*c*) Explain the effect of wind. Effect increases with distance from target.

(4) *Wind rule.*—State rule and explain it.

(5) *Wind-gage rule.*—State rule and explain it.

(6) *Elevation rule.*—State rule and explain it.

(7) *Light.*—Explain effect.

(8) *Mirage.*—Tell what it is and how it assists riflemen.

(9) *Shooting up or down hill.*—(*a*) Explain the effect on elevation.

(b) Remember this rule when shooting at hostile airplane.

(10) *Score book.*—(a) Explain the uses of score book on range.

(b) Have class open score books and explain items of keeping a score point by point.

(11) *Exercises.*—Give the class a number of small problems along the lines of the examples in paragraph 30*i* and *k* as a demonstration as to how the day's work is to be carried on.

(12) *Today's work.*—(a) Study and practice in sight setting, sight changing, and the use of score book. Squad leaders and other instructors will work up problems for their groups. Coach-and-pupil method is also used in which the coach states the conditions for the pupil.

(b) Additional practice in the exercises of the preceding days and rapid-fire exercises.

(13) Are there any questions?

(14) Next lecture will be tomorrow or ----- (State hour and place.)

■ 148. SIXTH LECTURE: RANGE PRACTICE.—This lecture and demonstration should immediately precede range firing. If the class is not too large, it should be given on a firing point of the rifle range.

*a.* The following equipment is necessary for the demonstrations:

(1) Material for blackening sight.

(2) One rifle with gun sling.

(3) One sandbag.

(4) One aiming device.

(5) Range dummy cartridges or practice dummy cartridges.

*b.* The following subjects are the ones usually discussed in the sixth lecture:

(1) *Preparatory work applied.*—Range practice is carried on practically the same as a trigger-squeeze exercise except that ball cartridges are used.

(2) *Coaching.*—Coach watches the man not the target. Coach does not keep the score for the pupil. Pupil must make his own entries in his score book. Coach sees that he does this.

(3) *Officers and noncommissioned officers.*—(a) Supervise and prompt the men acting as coaches.

(b) Personally coach pupils who are having difficulty in making good scores.

(4) *Spotters.*—(a) Use in both slow and rapid fire.

(b) If a spotter near the edge of the bull's-eye bothers the pupil in aiming, it may be removed before he fires again.

(5) *Sandbag rest.*—(a) Explain why it is used the first day or two of range firing.

(b) Demonstrate a coach adjusting the sandbag to a pupil.

(6) *Watching the eye.*—Explain how this indicates whether or not the pupil is squeezing the trigger properly.

(7) *Position of the coach.*—Demonstrate in each one of the positions.

(8) *Demonstration of coaching in slow fire.*—(a) Place a man on the firing point and show just what a coach does by calling attention to each item. See paragraph 38d (6).

(b) Demonstrate the use of the aiming device.

(c) Demonstrate the use of dummy cartridges in slow fire.

(d) Demonstrate coach squeezing the trigger for pupil.

(9) *Demonstration of coaching in rapid fire.*—Same procedure as in paragraph 38d (7).

(10) *Use of range dummy cartridges in rapid fire.*—(a) Show how dummy cartridges are mixed with service cartridges for rapid-fire training and explain why this is done.

(b) Coaches will be alert in this kind of practice in order to prevent pupil from looking into the chamber.

(11) *Read final precautions for slow fire.*—See paragraph 38.

#### SECTION IV

#### MARKSMANSHIP—AIR TARGETS

■ 149. *PRELIMINARY PREPARATION.*—a. The officer in charge of rifle antiaircraft training should be thoroughly familiar with the subject; should have detailed sufficient officers as assistant instructors; and should train the assistant instructors and a demonstration group before the first training period.

b. He should inspect the range and equipment in sufficient time prior to the first training period to permit correction of deficiencies.

■ 150. DESCRIPTION OF MINIATURE RANGE.—*a. Targets.*—(1) *Horizontal.*—This target is designed to represent a sleeve target towed by an airplane flying parallel to the firing point.

(2) *Double diving and climbing.*—This target is in two sections. The right section is designed to represent a sleeve target towed so as to pass obliquely across the front of the firing line in the manner of an airplane diving, if run from left to right, or climbing, if run from right to left. The left section is the same but represents an airplane diving from right to left and climbing from left to right.

(3) *Overhead.*—This target is designed to represent a sleeve target towed by an airplane which is approaching the firing line and will pass overhead, or when run in the opposite direction represents an airplane that has passed over the firing line.

*b. Size and speed of silhouette.*—The black silhouette is a representation at 500 inches of a 15-foot sleeve at a range of 330 yards. It is 7.5 inches long. The speed of the silhouette should be between 15 and 20 feet per second. This speed represents that of an airplane flying between 150 and 200 miles per hour at a range of 200 yards. The size and speed of the silhouette are based upon the time of flight of the caliber .22 bullet for 500 inches. This time of flight is approximately 0.04 second. When the target is moving at a speed of 15 feet or 180 inches per second it will move  $180 \times .04$  or 7.2 inches. Therefore in order to hit the silhouette the aim must be directed approximately one silhouette length in front of it. If two or three target-length (silhouette lengths) leads are used the shot will hit in the appropriate scoring spaces. This does not hold equally true on the overhead target. If the shot is fired when the range is less than 500 inches from the firer the lead necessary will be less than one target length.

■ 151. PREPARATORY EXERCISES.—*a.* A method of conducting the preparatory exercises is given in paragraph 65.

*b.* Each assistant instructor is assigned a target and conducts the preparatory training and firing of all groups on his target.

*c.* In preparatory training coach and pupil should change places frequently.

d. Forty-five minutes at each type of target should be sufficient to train each soldier in the preparatory exercises.

e. A detail of one noncommissioned officer and four or six men should be provided to operate each type of target.

■ 152. MINIATURE RANGE FIRING.—*a. Caliber .22 rifle.*—(1) The rifle should have the open sight.

(2) Two magazines for each caliber .22 rifle should be provided.

(3) Ammunition should be available immediately in rear of the firing line at each type of target.

(4) Coaches should load magazines as they become empty.

(5) Scorers should be detailed for each type of target. After each score is fired, they score the target. They call off the number of hits made on each silhouette and pencil the shot holes. The coaches enter the scores on the firer's score card.

(6) A platform permitting the scorer to score the target should be provided for each type of target.

(7) To stimulate interest, the instruction can be concluded with a competition between individuals, squads, or training groups.

(8) If available, targets as shown in figure 53 may be used on nonoverhead targets for group firing or competitions. Only one target-length lead may be used in firing on this target.

(9) Considerable supervision is required in order to maintain target operation at the proper speed. This speed is necessary because the lead is based upon a speed of from 15 to 20 feet per second.

(10) Safety precautions must be constantly observed.

*b. Caliber .30 rifle.*—If the size of the danger area permits, the caliber .30 rifle may be fired on the miniature range. Such firing may be conducted in the same manner as with the caliber .22 rifle with the following exceptions:

(1) The battle sight only is used.



FIGURE 53.

(2) The lead necessary to hit the black silhouette is approximately 2.5 inches. This is due to the difference in the time of flight of the caliber .30 and caliber .22 bullets for 500 inches. The time of flight of the caliber .30 bullet for 500 inches is 0.015 second. When the target is operated at the speed of 15 or 20 feet per second the silhouette will move approximately 2.5 inches during the time of flight of the bullet.

c. Using the battle sight the line of aim is lower than the trajectory of the bullet. Therefore it will be necessary to aim low in order to hit the silhouette. The aim should be directed at a point about 2 inches below the line of travel of the silhouette.

d. Men must be constantly cautioned to keep the weight of the body forward. This is to prevent them from being pushed over by the recoil of the weapon.

e. Preparatory exercises using the caliber .30 rifle should precede firing that weapon. These exercises are conducted as explained for the caliber .22 rifle.

f. The interval between individuals on the firing line should be increased. This may be accomplished by placing only one-half the group on the firing line at one time.

■ 153. TOWED-TARGET FIRING.—*a. Range organization.*—(1) Individual firing at a towed target being impracticable, all firing is done by a unit of such size that its fire can be readily controlled and directed. The platoon is the most convenient unit for such firing.

(2) An *ammunition line* should be established 10 yards in rear of the firing line. Small tables at the rate of one per 10 men in a firing group are desirable.

(3) Immediately in rear of the ammunition line the *ready line* should be established.

(4) The first platoon or similar group to fire is deployed along the ready line with each individual in rear of his place on the firing line. Other platoons or similar groups are similarly deployed in a series of lines in rear of the first unit to fire.

(5) Upon command of the officer in charge, the group on the ready line moves forward to the firing line securing ammunition en route; other groups close up.

(6) Upon completion of firing by one group it moves off the firing line passing around the flanks of the ready line so as not to interfere with the group moving forward.

(7) An ammunition detail sufficient to issue ammunition to groups as they move forward to the firing line and collect unfired ammunition from the group which just completed firing should be provided. These two operations should be performed simultaneously. Unfired ammunition is delivered to the statistical officer.

(8) The officer in charge should have at least 3 assistants—2 safety officers and 1 statistical officer.

*b. Ammunition.*—(1) Ball or tracer ammunition may be used. Tracer ammunition is of no assistance to the firer; it is useful to show the groups waiting to fire the size and density of the cone of fire delivered by the firing group.

(2) Tracer ammunition will assist the officer in charge in verifying the lead announced in the fire order. It also provides a means of checking the firer's estimate of the lead ordered.

*c. Fire distribution.*—(1) *Leads.*—(a) The maximum lead necessary to engage a sleeve target while it is within the firing area is required when it first enters the area and as it leaves the area. The minimum lead necessary is required when the sleeve is directly opposite the firing line. The lead used in the normal method of fire distribution is the average of these two extremes. For example: If the maximum slant range is 600 yards and the minimum slant range is 300 yards, the lead used would be that required for a slant range of 450 yards. All fire is delivered with the same lead.

(b) The lead table given below may be helpful. It is based upon a 15-foot sleeve towed at 200 miles per hour and M-2 ammunition.

<i>Slant range</i>	<i>Lead required</i>
100	2
200	5
300	8
400	11
500	14
600	18

The above leads were computed using the formula  $\frac{V \times T}{L}$  equals target-length leads required. This simple formula gives sufficiently accurate results for all practical purposes.  $V$  equals speed of target—200 m. p. h. or approximately 300 feet per second.  $T$  equals time of flight of bullet.  $L$  equals length of target—15 feet. For a slant range of 300 yards:  $\frac{300 \times .38}{15} = 7.6$  or 8 target-length leads. If the speed of the target is not 200 m. p. h. the lead to be used may be easily determined. For example: Speed of target is 140 miles per hour; 140 is seven-tenths of 200. Therefore at 300 yards slant range the lead necessary is  $0.7 \times 8 = 5.6 = 6$  target-length leads.

(2) The normal method of fire distribution is given in chapter 4. This method will be taught in towed-target range practice. If time and ammunition allowances permit, other methods may also be taught.

(3) *Variable lead method.*—(a) Using this method the individual rifleman fires each shot with a different lead. The maximum lead is used as the target enters and leaves the firing area. The minimum lead is used when the target is directly opposite the firing line. Example: Three rounds are to be fired as the sleeve target passes across the front of the firing line. The first round is fired shortly after the target enters the firing area; the second round is fired when the target is near the center of the firing area; the third shot is fired shortly before the sleeve leaves the firing area. The fire order given by the officer in charge is: 1. SLEEVE TARGET APPROACHING FROM THE LEFT (RIGHT), 2. 3 ROUNDS LOAD, 3. 14-8-14 TARGET-LENGTH LEADS, 4. COMMENCE FIRING. In this example it is expected that the three shots will be fired at slant ranges of approximately 500 yards, 300 yards, and 500 yards, respectively.

(b) This method has given good results but is more difficult to apply than the normal method.

(4) Safety precautions as given in paragraph 75 must be rigidly enforced. This requires constant supervision by the officer in charge.

(5) The results of all towed-target firing should be recorded and analyzed. The statistical officer should record the total



number of rounds fired and the hits obtained on each target. If the number of hits falls below the number expected the reason should be sought and explained to the men. On the other hand when results are satisfactory the men should be impressed with the value of rifle antiaircraft fire. The results of firing at sleeve targets moving at speeds of 130 to 150 miles per hour indicate that about one percent hits can be expected.

## SECTION V

### TECHNIQUE OF FIRE

■ 154. GENERAL.—The instructor should secure necessary equipment, inspect ranges, and detail and train necessary assistants, including demonstration units, prior to the first period of instruction. Instructors should use their initiative in arranging additional exercises in the application of the principles herein contained. It should be explained to trainees how the exercises used illustrate the principles in the technique of fire. Good work in the conduct of the exercises as well as errors should be called to the attention of all trainees.

■ 155. RANGE ESTIMATION.—*a.* A number of ranges to prominent points on the terrain should be measured so that a few minutes of each period can be devoted to range estimation.

*b.* Range cards as shown below will be of assistance in figuring percentage of errors.

RANGE ESTIMATION

Name -----

Company -----

Squad -----

Number	Estimate	Correct	Percent	Remarks	Number	Estimate	Correct	Percent	Remarks
1					21				
2					22				
3					23				
4					24				
5					25				
6					26				
7					27				
8					28				
9					29				
10					30				
11					31				
12					32				
13					33				
14					34				
15					35				
16					36				
17					37				
18					38				
19					39				
20					40				

(Front)

TABLE FOR COMPUTING ERRORS IN RANGE  
ESTIMATION

Range, in yards	Error, in yards										
	5	10	15	20	25	30	35	40	45	50	100
250.....	2	4	6	8	10	12	14	16	18	20	40
275.....	2	4	5	8	9	11	13	15	16	18	36
300.....	2	3	5	7	8	10	12	13	15	17	33
330.....	2	3	5	6	8	9	11	12	14	15	30
350.....	1	3	4	6	7	9	10	11	13	14	29
380.....	1	3	4	5	7	8	9	11	12	13	26
400.....	1	3	4	5	6	8	9	10	11	13	25
420.....	1	2	4	5	6	7	8	10	11	12	24
440.....	1	2	3	4	6	7	8	9	10	11	23
460.....	1	2	3	4	5	7	8	9	10	11	22
480.....	1	2	3	4	5	6	7	8	9	10	21
500.....	1	2	3	4	5	6	7	8	9	10	20
520.....	1	2	3	4	5	6	7	8	9	10	19
540.....	1	2	3	4	5	6	7	8	9	10	19
560.....	1	2	3	4	4	5	6	7	8	9	18
580.....	1	2	3	3	4	5	6	7	8	9	17
600.....	1	2	3	3	4	5	6	7	8	8	17
620.....	1	2	2	3	4	5	5	6	7	8	16
640.....	1	2	2	3	4	5	5	6	7	8	16
660.....	1	2	2	3	4	5	5	6	7	8	15
680.....	1	1	2	3	4	4	5	6	7	8	15
700.....	1	1	2	3	3	4	5	6	6	7	14
720.....	1	1	2	3	3	4	5	6	6	7	14
740.....	1	1	2	3	3	4	5	6	6	7	14
760.....	0	1	2	3	3	4	5	5	6	7	13
780.....	0	1	2	3	3	4	4	5	6	6	13
800.....	0	1	2	3	3	4	4	5	6	6	13
850.....	0	1	2	2	3	3	4	5	5	6	12
900.....	0	1	2	2	3	3	4	4	5	6	11
950.....	0	1	2	2	3	3	4	4	5	5	11
1,000.....	0	1	2	2	3	3	4	4	5	5	10

NOTE.—Example of the use of this table: Suppose the correct range to be 695 yards and the estimated range to be 635. The "error in estimate" is consequently 60 yards. Select two "errors in estimate" in the 700-yard space (the nearest to the correct range given in the table) whose sum is 60 yards, as 50 and 10. Add the percentages shown thereunder, and the result will be approximately your error. In this case:

$$7 \text{ plus } 1 = 8\%$$

(Rear)

■ 156. TARGET DESIGNATION.—a. The major portion of the time devoted to target designation should be spent on oral description. Simple designations should be required at first. This instruction should not be confined to the landscape panels.

b. An explanation should be made to the trainees as to why an angle of 50 mils will be subtended by 1 foot at 20 feet.

■ 157. RIFLE FIRE AND ITS EFFECT.—This step of instruction can best be covered by the use of a blackboard and several riflemen firing tracer bullets to demonstrate the trajectory, danger space, dispersion, classes of fire, etc.

■ 158. APPLICATION OF FIRE.—*a.* Sufficient time and explanation should be devoted to the method of fire distribution to insure that all men fully understand it and can explain it in their own words.

*b.* A demonstration squad simulating firing should suffice to show the technique employed in assault fire.

■ 159. LANDSCAPE-TARGET FIRING.—*a.* An explanation and demonstration will be necessary to show the technique and procedure of zeroing rifles and the firing of exercises on the landscape targets.

*b.* Units should be given practical work in writing fire orders for targets on the landscape panels prior to their firing of any exercises.

■ 160. FIRING AT FIELD TARGETS.—*a.* The most difficult factor in the preparation of problems for field firing is the selection of the terrain which complies with the safety regulations contained in AR 750-10. A drawing should be made on a map showing all safety angles, target positions, etc.

*b.* The appearance of the ordinary prone or kneeling silhouette depends a great deal upon the direction of the sun, the background of the targets, and the angle at which the targets are placed. The effect of solidity can be obtained by using two figures placed at right angles to one another. The effect of fire distribution on a linear target can be determined by using a screen of E targets nailed end to end; the screen should be located so as not to disclose the position of concealed targets.

*c.* Maximum use should be made of the available terrain to permit the firing of as many squads from one firing position at one time as is possible. This firing should be controlled from a central location. Telephone communication between the firing point and the pits will facilitate this instruction. During this type of training, individuals and units should approach and occupy their firing positions with due regard to

cover and concealment, after which men are rearranged on the firing position according to the requirements of safety.

*d.* When sufficient time and ammunition are available, platoon exercises should be conducted.

*e.* About 60 to 70 percent of the score allotted for the grading of units should be given for such parts of the exercise as the approach march and occupation of the firing position, fire orders, time required to open fire, rate of fire, and fire control. The remaining 30 or 40 percent should be given for the number of hits on the targets and the number of targets hit.

APPENDIX I  
AMMUNITION

---

■ 1. GENERAL.—The information in this appendix pertaining to the several types of cartridges authorized for use in the U. S. rifle, caliber .30, M1903, includes a description of the cartridges, means of identification, care, use, and ballistic data.

■ 2. CLASSIFICATION.—*a.* (1) Based upon use, the principal classification of ammunition for this rifle is—

(a) Ball, for use against personnel and light matériel targets.

(b) Tracer, for observation of fire and incendiary purposes.

(c) Armor-piercing, for use against armored vehicles, concrete shelters, and similar bullet-resisting targets.

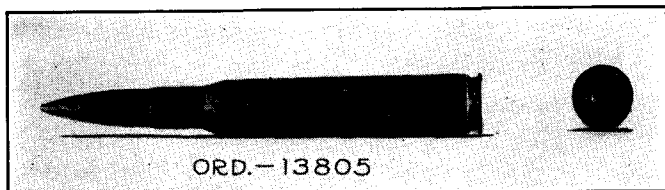

FIGURE 1.—Cartridge, ball, cal. .30, M2.

(2) The following types are similar to ball, except for the following:

(a) Armor-piercing is painted black for  $\frac{1}{4}$  inch from the point.

(b) Tracer is painted red for  $\frac{1}{4}$  inch from the point.

(c) Range dummy is identical with ball except for a short narrow slot cut in the side of the cartridge case near the base.

*b.* Other types, provided for special purposes are—

(1) Guard, for guard purposes.

(2) Blank, for simulated fire, signaling, and salutes.

(3) Dummy, for training (cartridges are inert).

(4) Range dummy.

APPENDIX I

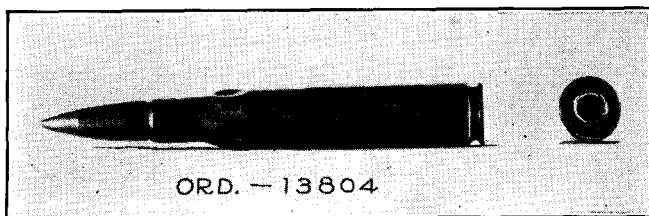

FIGURE 2.—Cartridge, guard, cal. .30, M1906. (Similar to ball, except the cartridge case has six short flutes or corrugations just below the neck.)

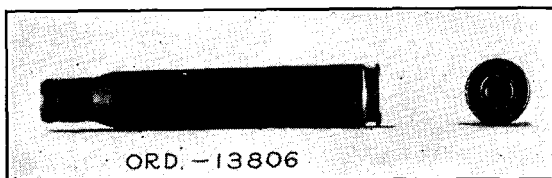

FIGURE 3.—Cartridge, blank, cal. .30, M1909.

■ 3. AMMUNITION LOT NUMBER.—When ammunition is manufactured, an ammunition lot number which becomes an essential part of the marking is assigned in accordance with pertinent specifications. This lot number is marked on all packing containers and on the identification card inclosed in each packing box. It is required for all purposes of record including grading and use, reports on condition, functioning, and accidents, in which the ammunition might be involved. Only those lots of grades appropriate for the weapon will be fired. Since it is impractical to mark the ammunition lot number on each individual cartridge, every effort will be made to maintain the ammunition lot number with the cartridges once the cartridges are removed from their original packing. Cartridges which have been removed from the original packing and for which the ammunition lot number has been lost are placed in grade 3. It is therefore obvious that when cartridges are removed from their original packings they should be so marked that the ammunition lot number is preserved.

## APPENDIX I

■ 4. **GRADE.**—Current grades of all existing lots of small arms ammunition are established by the Chief of Ordnance and are published in Ordnance Field Service Bulletin No. 3-5. No lot will be fired in any weapon other than that appropriate to the current grade of the lot involved. Color bands, painted on the sides and ends of the packing boxes, further identify the various types of ammunition. The following color bands are used:

Cartridge, armor-piercing.....	Blue on yellow.
Cartridge, ball.....	Red.
Cartridge, ball, and cartridge, tracer, in metallic link belts*.....	Composite band of yellow, red, and green stripes (yellow on left, red in center, green on right).
Cartridge, blank.....	Blue.
Cartridge, dummy.....	Green.
Cartridge, gallery practice.....	Brown.
Cartridge, guard.....	Orange.
Cartridge, tracer.....	Green on yellow.

\*Special packing for Air Corps, not for use in the M1903 rifle.

■ 5. **CARE, HANDLING, AND PRESERVATION.**—*a.* Small arms ammunition as compared with other types is not dangerous to handle. Care however must be observed to keep the boxes from becoming broken or damaged. All broken boxes must be immediately repaired and careful attention should be given that all markings are transferred to the new parts of the box. The metal liner should be air tested and sealed if equipment for this work is available.

*b.* Ammunition boxes should not be opened until the ammunition is required for use. Ammunition removed from the airtight container, particularly in damp climates, is apt to corrode, thereby causing the ammunition to become unserviceable.

*c.* Protect the ammunition carefully from mud, sand, dirt, and water. If it gets wet or dirty wipe it off at once. Light corrosion, if it forms on cartridges, should be wiped off. However, cartridges should not be polished to make them look better or brighter.

*d.* No caliber .30 ammunition (other than blanks) will be fired until it has been positively identified by ammunition lot number and grade as published in the latest revision or change to Ordnance Field Service Bulletin No. 3-5.



■ 6. CARTRIDGE, BALL, CALIBER .30, M2 AND M1.—The maximum range for M2 is approximately 3,450 and for M1, 5,500 yards. The M2 type is standard. The manufacture of M1 type has been discontinued.

■ 7. PRECAUTIONS IN FIRING BLANK AMMUNITION.—*a.* It is dangerous to fire rifles loaded with blank cartridges at personnel representing an enemy at distances of less than 20 yards as the wad or paper cup may fail to break up.

*b.* Misfires in which the primer explodes but fails to ignite the powder charge may prove dangerous when blank ammunition is being fired. In this type of misfire, some of the powder is blown into the bore of the weapon. A series of such rounds in which the powder fails to ignite due to moisture or other causes will result in an accumulation of powder sufficient to cause serious damage when ignited by a normal cartridge. When misfires are encountered in blank ammunition in excess of 5 percent, the firing of the lot will be suspended and reported to the Chief of Ordnance.

APPENDIX II

LIST OF REFERENCES

TR 1300-22A.  
TR 1300-30A.  
TR 1350-A.  
TR 1400-30A.  
SNL B-3.  
SNL B-21.



## INDEX

	Paragraph	Page
Advice to instructors, purpose.....	132	180
Aiming.....	26	23
Lecture for.....	143	188
Aiming and leading exercises.....	67	120
Air targets:		
Classification.....	58	113
Preparation for marksmanship.....	149	198
Suitable for rifle fire.....	57	113
	139	182
Ammunition.....	1-7	209-212
	(App. I)	
Antiaircraft marksmanship:		
Exercises:		
Aiming and leading.....	67	120
Position.....	66	119
Preparatory.....	65	118
Trigger squeeze.....	68	123
Instruction in.....	64	117
Application of fire.....	106, 159, 158	159, 207
Application of leads, moving targets.....	50, 60	108, 114
Assault fire.....	108	162
Assistant instructors.....	136	181
Basic principles of firing at moving targets.....	49	107
Beaten zone, rifle fire.....	102	156
Blackening sights.....	25	22
Care of rifle:		
After firing.....	10	9
In garrison.....	9	8
In the field.....	11	10
On the range.....	12	10
Classes of rifle fire.....	103	158
Classification of moving air targets.....	58	113
Cleaning of rifle:		
After firing.....	10	9
Disassembling.....	8	5
Importance.....	6	4
In garrison.....	9	8
Inspection.....	7	4
In the field.....	11	10
On the range.....	12	10
Commanders, duties and equipment.....	23	18
Concentrated fire.....	107	160
Continuous practice.....	21	18
Small-bore.....	46	102
Courses:		
For small-bore practice.....	47	102
For towed-target firing.....	74	130
Qualification.....	33-36	64-71
Critique for fire exercises.....	130	177

## INDEX

	Paragraph	Page
Delivery of fire.....	63	116
Demonstrations.....	142	187
Description of landscape target.....	115	166
Description of rifle.....	1	1
Determination of leads, moving targets.....	50,	108,
	60	114
Dimensions of rifle.....	2	1
Disassembling rifle for cleaning.....	8	5
Dispersion, rifle fire.....	100	156
Distributed fire.....	107	160
Duties of commanders and leaders.....	23,	18,
	113	165
Effect of rifle fire.....	104,	158,
	157	207
Equipment:		
For instructors.....	137	181
For marksmanship training.....	40	92
Of commanders and leaders.....	23	18
Estimation of range by eye.....	91	145
Examination before starting range practice.....	31	59
Exercises:		
Aiming and leading.....	67	120
Fire.....	129,	176,
	131	177
Landscape-target firing.....	121	170
Position.....	66	119
Preparatory.....	65	118
Air-target marksmanship.....	151	199
Rifle fire.....	105	159
Target designation.....	98	153
Trigger squeeze.....	68	123
Field glass, type EE.....	15	13
Field-target firing:		
General considerations.....	128	175
Purpose.....	122	171
Safety precautions.....	127	174
Scope.....	123	171
Field targets, firing at.....	160	207
Fire:		
Application.....	106,	159,
	158	207
Assault.....	108	162
Classes of.....	103	158
Concentrated and distributed.....	107	160
Control.....	111	163
Delivery.....	63	116
Discipline.....	110	162
Distribution.....	62	115
Effect.....	104,	158,
	157	207
Exercises.....	129,	176,
	131	177
Observation.....	90	145
Orders.....	112	164

INDEX

	Paragraph	Page
Fire—Continued.		
Rate of-----	4, 109	4, 162
Technique-----	51, 53, 59, 154	109, 114, 204
Firing:		
At field targets-----	160	207
Group-----	72	129
Instruction-----	71	128
Landscape-target-----	159	207
Procedure-----	119	169
Towed-target-----	73, 153	130, 201
Fundamentals of training-----	18	17
Group firing, miniature range practice-----	72	129
Importance of—		
Cleaning rifle-----	6	4
Landscape-target firing-----	114	165
Range estimation-----	87	144
Rifle fire-----	85	143
Target designation-----	92	148
Inspection of rifles-----	7, 138	4, 182
Instruction:		
Anti-aircraft marksmanship-----	64	117
Firing:		
Miniature range practice-----	71	128
Moving ground targets-----	55	110
Practice-----	38	73
Recruit-----	22	18
Instructions to pilots for towing targets-----	82	137
Instructors:		
Advice to-----	132	180
Assistant-----	136	181
Equipment for-----	137	181
Landscape target, description-----	115	166
Landscape-target firing-----	159	207
Exercises-----	121	170
Preparation of targets for-----	117	166
Procedure-----	119	169
Scope and importance-----	114	165
Scoring-----	120	170
Weapons to be used-----	116	166
Leaders, duties and equipment-----	23, 113	18, 165
Lectures-----	142	187
Effect of wind and light-----	147	196
Place of assembly for-----	135	181
Positions-----	144	190
Range practice-----	148	197
Rapid fire-----	146	194
Scorebook-----	147	196
Sight changes-----	147	196
Sighting and aiming-----	143	188
Trigger squeeze-----	145	192

## INDEX

	Paragraph	Page
<b>Marksmanship:</b>		
Instruction in antiaircraft.....	64	117
Preparatory training.....	24	19
Targets:		
Air, preparation for.....	149	198
Known-distance.....	41,	96,
	134	181
Mechanical training, conduct.....	133	180
Miniature range.....	79	134
Description of, air targets.....	150	199
Firing.....	152	200
Practice.....	69	127
Model schedules.....	141	186
<b>Moving targets:</b>		
Air:		
Classification.....	58	113
Delivery of fire at.....	63	116
Designation.....	61	115
Fire distribution.....	62	115
Leads at.....	60	114
Suitable for rifle fire.....	57	113
Technique of fire.....	59	114
Ground:		
Determination of leads.....	50	108
Safety precautions.....	56	111
Technique of fire.....	51, 53	109
Necessity for training.....	17	16
Nomenclature.....	5	4
Object of small-bore practice.....	44	101
Observation of fire.....	90	145
Operation of rifle.....	13	10
Oral description, target designation.....	97	149
Organization of work for training practice.....	140	182
Phases of training.....	19	17
Pointing targets.....	96	149
Position exercises, antiaircraft marksmanship.....	66	119
<b>Positions:</b>		
Instruction in.....	27	28
Lecture for.....	144	190
Practice, continuous.....	21	18
Practice seasons.....	20	17
Preparation of targets.....	117	166
<b>Preparatory exercises:</b>		
Antiaircraft marksmanship.....	65	118
Marksmanship, air targets.....	151	199
Preparatory training, marksmanship.....	24	19
Procedure of towed-target firing.....	76	132
Purpose of field-target firing.....	122	171
Purpose of marksmanship.....	16	16
<b>Qualification courses:</b>		
A.....	33	64
B.....	34	66
C.....	35	68
D.....	36	70

INDEX

	Paragraph	Page
Range -----	4	4
Miniature -----	79,	134,
Lecture for -----	150,	199,
Practice -----	152	200
Lecture for -----	69	127
Examination before starting -----	37	71
Lecture for -----	31	59
Towed target -----	148	197
Range estimation -----	80	136
Importance -----	155	204
Methods -----	87	144
Range officer -----	88, 91	145
Rapid fire:	78	133
Instruction in -----	29	41
Lecture for -----	146	194
Rate of fire -----	4, 109	4, 162
Rear sight -----	3	3
Record practice -----	39	79
Recruit instruction -----	22	18
References -----	5	4
Rifle fire:		
Effect -----	157	207
Importance -----	85	143
Scope of training -----	84	143
Steps in -----	86	144
Rifles:		
Inspection -----	7, 138	4, 182
Zeroing-in -----	118	168
Rules for safety precautions -----	14	12
Safety precautions:		
Field-target firing -----	127	174
Firing at moving targets -----	56	111
Miniature range practice -----	70	127
Rules -----	14	12
Towed-target firing -----	75	131
Schedules, model -----	141	186
Scope of—		
Field-target firing -----	123	171
Landscape-target firing -----	114	165
Marksmanship training -----	48	107
Rifle-fire technique -----	84	143
Score book:		
Lecture for -----	147	196
Use -----	30	50
Scoring:		
Landscape-target firing -----	120	170
Towed-target firing -----	77	133
Shelter for target operators -----	126	174
Shot groups, rifle fire -----	101	156
Sight changes -----	30	50
Lecture for -----	147	196
Sighting and aiming -----	26	23
Lecture for -----	143	188
Sights, blackening -----	25	22
Signals, towed-target firing -----	83	139



## INDEX

	Paragraph	Page
Small-bore practice:		
Continuous-----	46	102
Courses-----	47	102
Object-----	44	101
Value-----	45	102
Target designation-----	61, 156	115, 206
Exercises-----	98	153
Importance-----	92	148
Instruction-----	93	148
Methods-----	94	148
Oral description-----	97	149
Target ranges, known-distance-----	42	97
Targets-----	125	172
Field, firing at-----	160	207
For field-target firing-----	125	172
For landscape-target firing-----	117	166
Marksmanship-----	41	96
Moving:		
Air:		
Classification-----	58	113
Delivery of fire at-----	63	116
Designation-----	61	115
Fire distribution-----	62	115
Leads-----	60	114
Suitable for rifle fire-----	57	113
Technique of fire-----	59	114
Basic principles of firing at-----	49	107
Ground:		
Instruction in firing at-----	55	110
Safety precautions in firing at-----	56	111
Technique of fire-----	51, 53	109
Vehicles, leads at-----	50	108
Pointing-----	96	149
Preparation-----	117	166
Towed-----	81	137
Technique of fire-----	51, 53, 59, 154	109, 114, 204
Place in training-----	52, 54	109, 110
Terrain, selection-----	124	172
Towed-target firing-----	73, 153	130, 201
Towed-target range-----	80	136
Tracer bullets, use-----	89, 95	145, 148
Training:		
Fundamentals of-----	18	17
Mechanical, conduct-----	133	180
Necessity for-----	17	16
Phases-----	19	17
Preparatory marksmanship-----	24	19
Purpose-----	16	16
Scope of marksmanship-----	48	107
Trajectory, rifle fire-----	99	156

## INDEX

	Paragraph	Page
Trigger squeeze:		
Exercises, antiaircraft marksmanship-----	68	123
Instruction-----	28	39
Lecture for-----	145	192
Value of small-bore practice-----	45	102
Vehicles, moving, leads at-----	50	108
Weapons for landscape-target firing-----	116	166
Weight of rifle-----	2	1
Wind, effect-----	30	50
Lecture for-----	147	196
Zeroing-in of rifles-----	118	168



## BASIC FIELD MANUAL

## U. S. RIFLE, CALIBER .30, M1903

CHANGES }  
 No. 1 }

WAR DEPARTMENT,  
 WASHINGTON, September 10, 1940.

FM 23-10, January 2, 1940, is changed as follows, *effective October 1, 1940*:

■ 33. COURSE A.—*a. Instruction practice.*

TABLE I.—*Slow fire*

Range (inches)	Time	Shots	Target	Position	Sling
1,000	No limit..	5	A, 1,000-inch....	Prone. Sandbag optional.	Loop.
1,000	---do-----	5	---do-----	Prone.....	Do.
1,000	---do-----	5	---do-----	Sitting.....	Do.
1,000	---do-----	5	---do-----	Kneeling.....	Do.
1,000	---do-----	5	---do-----	Standing.....	Hasty.

TABLE II.—*Rapid fire*

Range (inches)	Time (seconds)	Shots	Target	Position	Sling
1,000	60.....	15	D, 1,000-inch....	Prone from standing.....	Loop.
1,000	60.....	15	---do-----	Sitting or kneeling from standing.	Do.

<sup>1</sup> See par. 38c(2).  
 257130°—40

U. S. RIFLE, CALIBER .30, M1903

TABLE V.—*Slow fire*

Range (yards)	Time	Shots	Target	Position	Sling
200	No limit	10	A.....	Sitting.....	Loop.
200	do.....	10	A.....	Kneeling.....	Do.
200	do.....	10	A.....	Standing.....	Hasty.

TABLE VI.—*Rapid fire*

Range (yards)	Time (seconds)	Shots	Target	Position	Sling
200	60.....	15	D.....	Sitting from standing.....	Loop.
200	60.....	15	D.....	Kneeling from standing.....	Do.
300	70.....	15	D.....	Prone from standing.....	Do.

<sup>1</sup> See par. 38c(2).

TABLE VII.—*Rapid fire*

Range (yards)	Time (seconds)	Shots	Target	Position	Sling
200	60.....	10	D.....	Sitting from standing.....	Loop.
200	60.....	10	D.....	Kneeling from standing.....	Do.
300	70.....	10	D.....	Prone from standing.....	Do.

b. *Record practice.*

TABLE VIII.—*Slow fire*

Range (yards)	Time	Shots	Target	Position	Sling
200	No limit	10	A.....	Standing.....	Hasty.
300	do.....	10	A.....	5 kneeling; 5 sitting.....	Loop.
500	do.....	10	B.....	Prone.....	Do.

U. S. RIFLE, CALIBER .30, M1903

TABLE IX.—*Rapid fire*

Range (yards)	Time (seconds)	Shots	Target	Position	Sling
200	60.....	10	D.....	Kneeling from standing...	Loop.
200	60.....	10	D.....	Sitting from standing....	Do.

TABLE X.—*Rapid fire*

Range (yards)	Time (seconds)	Shots	Target	Position	Sling
300	70.....	10	D.....	Prone from standing.....	Loop.

[A. G. 062.11 (6-20-40).] [C1, Sept. 10, 1940.]

■ 34. COURSE B.—*a. Instruction practice.*

TABLE I.—*Slow fire*

Range (inches)	Time	Shots	Target	Position	Sling
1,000	No limit..	5	A, 1,000-inch...	Prone. Sandbag optional.	Loop.
1,000	do.....	5	do.....	Prone.....	Do.
1,000	do.....	5	do.....	Sitting.....	Do.
1,000	do.....	5	do.....	Kneeling.....	Do.
1,000	do.....	5	do.....	Standing.....	Hasty.

TABLE II.—*Rapid fire*

Range (inches)	Time (seconds)	Shots	Target	Position	Sling
1,000	60	<sup>1</sup> 5	D, 1,000-inch...	Prone from standing.....	Loop.
1,000	60	<sup>1</sup> 5	do.....	Sitting or kneeling from standing.	Do.

<sup>1</sup> See par. 38c(2).

\* \* \* \* \*

U. S. RIFLE, CALIBER .30, M1903

TABLE IV.—*Slow fire*

Range (yards)	Time	Shots	Target	Position	Sling
200	No limit	10	A.....	Sitting.....	Loop.
200	do.....	10	A.....	Kneeling.....	Do.
200	do.....	10	A.....	Standing.....	Hasty.

TABLE V.—*Rapid fire*

Range (yards)	Time (seconds)	Shots	Target	Position	Sling
200	60	15	D.....	Sitting from standing.....	Loop.
200	60	15	D.....	Kneeling from standing.....	Do.
300	70	15	D.....	Prone from standing.....	Do.

<sup>1</sup> See par. 38c(2).

TABLE VI.—*Rapid fire*

Range (yards)	Time (seconds)	Shots	Target	Position	Sling
200	60.....	10	D.....	Kneeling from standing.....	Loop.
200	60.....	10	D.....	Sitting from standing.....	Do.
300	70.....	10	D.....	Prone from standing.....	Do.

*b. Record practice.*

TABLE VII.—*Slow fire*

Range (yards)	Time	Shots	Target	Position	Sling
200	No limit.....	10	A.....	Standing.....	Hasty.
300	do.....	10	A.....	5 kneeling; 5 sitting.....	Loop.

\* \* \* \* \*

U. S. RIFLE, CALIBER .30, M1903

TABLE IX.—*Rapid fire*

Range (yards)	Time (seconds)	Shots	Target	Position	Sling
200	60.....	10	D.....	Sitting from standing.....	Loop.
200	60.....	10	D.....	Kneeling from standing...	Do.

[A. G. 062.11 (6-20-40).] [C 1, Sept. 10, 1940.]

■ 35. COURSE C.—*a. Instruction practice.*

TABLE I.—*Slow fire*

Range (inches)	Time	Shots	Target	Position	Sling
1,000	No limit...	5	A, 1,000-inch...	Prone. Sandbag optional.	Loop.
1,000	do.....	5	do.....	Prone.....	Do.
1,000	do.....	5	do.....	Sitting.....	Do.
1,000	do.....	5	do.....	Kneeling.....	Do.
1,000	do.....	5	do.....	Standing.....	Hasty.

TABLE II.—*Rapid fire*

Range (inches)	Time (seconds)	Shots	Target	Position	Sling
1,000.....	60.....	15	D, 1,000 inch...	Prone from standing.....	Loop.
1,000.....	60.....	15	do.....	Sitting or kneeling from standing.	Do.

<sup>1</sup> See par. 38c(2).

TABLE III.—*Slow fire*

Range (yards)	Time	Shots	Target	Position	Sling
200.....	No limit...	5	A.....	Prone. Sandbag optional.	Loop.
200.....	do.....	5	A.....	Prone.....	Do.
200.....	do.....	5	A.....	Sitting.....	Do.
200.....	do.....	5	A.....	Kneeling.....	Do.
200.....	do.....	5	A.....	Standing.....	Hasty.

U. S. RIFLE, CALIBER .30, M1903

TABLE IV.—*Rapid fire*

Range (yards)	Time (seconds)	Shots	Target	Position	Sling
200.....	60.....	15	D.....	Sitting from standing.....	Loop.
200.....	60.....	15	D.....	Kneeling from standing....	Do.
200.....	60.....	15	D.....	Prone from standing.....	Do.

<sup>1</sup> See par. 38c(2).

*b. Record practice.*

TABLE V.—*Slow fire*

Range (yards)	Time	Shots	Target	Position	Sling
200.....	No limit...	10	A.....	5 sitting; 5 kneeling.....	Loop.
200.....	.....do.....	10	A.....	Standing.....	Hasty.

TABLE VI.—*Rapid fire*

Range (yards)	Time (seconds)	Shots	Target	Position	Sling
200.....	60.....	10	D.....	Kneeling from standing....	Loop.
200.....	60.....	10	D.....	Sitting from standing.....	Do.

[A. G. 082.11 (6-20-40).] [C 1, Sept. 10, 1940.]

■ 36. COURSE D.—*a. Instruction practice.*

TABLE I.—*Slow fire*

Range (inches)	Time	Shots	Target	Position	Sling
1,000...	No limit..	10	A, 1,000-inch...	Prone. Sandbag optional.	Loop.
1,000...	.....do.....	10	.....do.....	Prone.....	Do.
1,000...	.....do.....	10	.....do.....	Sitting.....	Do.
1,000...	.....do.....	10	.....do.....	Kneeling.....	Do.
1,000...	.....do.....	10	.....do.....	Standing.....	Hasty.



U. S. RIFLE, CALIBER .30, M1903

TABLE II.—*Rapid fire*

Range (inches)	Time (seconds)	Shots	Target	Position	Sling
1,000---	60-----	15	D, 1,000-inch--	Prone from standing-----	Loop.
1,000---	60-----	15	---do-----	Sitting from standing-----	Do.
1,000---	60-----	15	---do-----	Kneeling from standing--	Do.

<sup>1</sup> See par. 38c(2).

*b. Record practice.*

TABLE III.—*Slow fire*

Range (inches)	Time	Shots	Target	Position	Sling
1,000---	No limit---	10	A, 1,000-inch---	5 kneeling; 5 sitting-----	Loop.
1,000---	---do-----	10	---do-----	Standing-----	Hasty.

TABLE IV.—*Rapid fire*

Range (inches)	Time (seconds)	Shots	Target	Position	Sling
1,000---	60-----	10	D, 1,000-inch--	Kneeling from standing---	Loop.
1,000---	60-----	10	---do-----	Sitting from standing-----	Do.

[A. G. 062.11 (6-20-40).] [C1, Sept. 10, 1940.]

■ 47. COURSES.—*a.* \* \* \*

(1) *Course E.—(a) Instruction practice.*

1. *Short range.*

\* \* \* \* \*

U. S. RIFLE, CALIBER .30, M1903

TABLE III.—*Rapid fire*

Range (feet)	Time (seconds)	Shots	Targets	Position	Sling
50.....	60.....	10	SB-D-2.....	Standing to kneeling.....	Loop.
50.....	70.....	10	SB-D-3.....	Standing to prone.....	Do.

NOTE.—When desired, tables I, II, and III may be fired at 1,000 inches by substituting target A, 1,000-inch, for targets SB-A-2 and A-3; target B, 1,000-inch, for targets SB-B-5; and target D, 1,000-inch, for targets SB-D-2 and D-3.

2. *Intermediate range.*

TABLE IV.—*Slow fire*

Range (yards)	Time	Shots	Targets	Position	Sling
50.....	No limit..	10	SB-50 yards, A target.	Prone.....	Loop.
50.....	do.....	10	do.....	5 kneeling; 5 sitting.....	Do.

TABLE V.—*Rapid fire*

Range (yards)	Time (seconds)	Shots	Targets	Position	Sling
50.....	70.....	10	SB-50 yards, D target.	Prone from standing.....	Loop.
50.....	70.....	10	do.....	Sitting from standing....	Do.
50.....	75.....	10	do.....	Kneeling from standing...	Do.

NOTE.—The firing included in tables IV and V is optional. If no 50-yard range is available, tables IV and V will be fired at 100 yards on the SB-100 yards, D target. This applies only to the E course.

3. *Long range.*

U. S. RIFLE, CALIBER .30, M1903

TABLE VI.—*Slow fire*

Range (yards)	Time	Shots	Targets	Position	Sling
100	No limit..	10	SB-100 yards, A target.	Prone.....	Loop.
100	.....do.....	10	.....do.....	5 kneeling; 5 sitting.....	Do.
100	.....do.....	10	SB-100 yards, D target.	Prone.....	Do.

TABLE VII.—*Rapid fire*

Range (yards)	Time (seconds)	Shots	Targets	Position	Sling
100	80.....	10	SB-100 yards, D target.	Prone from standing.....	Loop.
100	80.....	10	.....do.....	Sitting from standing.....	Do.

(b) *Record practice.*

TABLE VIII.—*Slow fire*

Range (yards)	Time	Shots	Targets	Position	Sling
100	No limit..	10	SB-100 yards, A target.	5 kneeling; 5 sitting.....	Loop.
100	.....do.....	10	SB-100 yards, A target.	Prone.....	Do.

TABLE IX.—*Rapid fire*

Range (yards)	Time (seconds)	Shots	Targets	Position	Sling
100	80.....	10	SB-100 yards, D target.	Prone from standing.....	Loop.
100	80.....	10	.....do.....	Sitting from standing.....	Do.

\* \* \* \* \*

U. S. RIFLE, CALIBER .30, M1903

(3) *Course G.—(a) Instruction practice.*

*Short range.—Fire tables I, II, and III of course E.*

TABLE XIV.—*Rapid fire*

Range (feet)	Time (seconds)	Shots	Targets	Position	Sling
50	70.....	10	SB-D-3.....	Prone from standing, 25 yards. Sitting from standing.....	Loop.
50	70.....	10	.....do.....		Do.

(b) *Record practice.*

TABLE XV.—*Slow fire*

Range (feet)	Time	Shots	Targets	Position	Sling
50	No limit...	10	SB-A-3.....	5 kneeling; 5 sitting..... Prone.....	Loop.
50	.....do.....	10	SB-B-5.....		Do.

TABLE XVI.—*Rapid fire*

Range (feet)	Time (seconds)	Shots	Targets	Position	Sling
50	70.....	10	SB-D-3.....	Prone from standing..... Sitting from standing.....	Loop.
50	70.....	10	.....do.....		Do.

[A. G. O. 62.11 (6-20-40).] [C1, Sept. 10, 1940.]

■ 127. SAFETY.

*d.* Firing will not start until it has been ascertained that the range is clear, pit details are not exposed, and *all safety precautions complied with.* Upon completion of firing, the officer in charge will cause all rifles and belts to be unloaded

U. S. RIFLE, CALIBER .30, M1903

and inspected, and all ammunition collected so that none remains in the possession of the men returning to camp or barracks.

\* \* \* \* \*

[A. G. 062.11 (5-3-40).] [C1, Sept. 10, 1940.]

BY ORDER OF THE SECRETARY OF WAR:

G. C. MARSHALL,  
*Chief of Staff.*

OFFICIAL:

E. S. ADAMS,  
*Major General,*  
*The Adjutant General.*