

C-1 15 June 45
MHI
Copy 3

FM 4-10

WAR DEPARTMENT FIELD MANUAL

MARC
COPY

REGRADED UNCLASSIFIED BY USAR
AUTHORITY DOD DIR. 5200.1 R
BY BRK/als ON 8/23/83

COAST ARTILLERY

GUNNERY

MILITARY POLICE BOARD

RESTRICTED DISSEMINATION OF RESTRICTED MATTER.
The information contained in restricted documents and the essential characteristics of restricted material may be given to any person known to be in the service of the United States and to persons of undoubted loyalty and discretion who are cooperating in Government work, but will not be communicated to the public or to the press except by authorized military public relations agencies. (See also par. 23b, AR 380-5, 15 Mar 1944.)

U.S. Army Military History Institute

WAR DEPARTMENT • 20 MAY 1944

WAR DEPARTMENT FIELD MANUAL

**COAST ARTILLERY
GUNNERY**

CHANGES } WAR DEPARTMENT
No. 1 } WASHINGTON 25, D.C., 15 June 1945

FM 4-10, 20 May 1944, is changed as follows:

* * * * *

**20. CONDITIONS AFFECTING RANGE. a.
Height of site.**

* * * * *

(2) The height of tide * * * above or below the same datum. In **certain** fixed batteries, the range-elevation scale * * * upon the type of firing table being used.

* * * * *

d. Density. The density of the air * * * and vice versa. The ballistic density in percent of standard, **to the nearest 0.1 percent**, so corrected is then applied to the range correction board, which mechanically determines the proper range percentage correction. * * * on the range.

e. Air temperature.

* * * * *

(4) When the temperature is not standard (59° F.) * * * is necessary. The temperature is taken

from the meteorological message. **The meteorological message gives the ballistic temperature for each standard altitude zone in degrees Fahrenheit.** The temperature must be corrected, * * * the temperature increases $\frac{1}{5}^{\circ}$ F. **In the event a meteorological message is not available, or if the one that is available is unreliable because of subsequent changes in meteorological conditions, the thermometer reading at the battery may be taken as the temperature.** The temperature is applied on the range correction board. The mechanical correction * * * effect on the range.

* * * * *

22. PRECISION REQUIRED IN FIRING TABLE COMPUTATIONS.

* * * * *

c. Miscellaneous.

Density..... 0.1 percent

* * * * *

24. 6-INCH GUN BATTERY. (Superseded.) A 6-inch gun battery M1905A2 on carriage M1 is to fire, using shot, AP, Mk. XXXIII, fuze B.D. M60 (FT 6-E-2). With the following data assumed, compute the corrected quadrant elevation and corrected azimuth. (All page references in the problem refer to FT 6-E-2, 1943.)

Map range to target.....	9,400 yards
Azimuth of target.....	270° (S.) or 90° (N.)
Muzzle velocity (previous firings)....	2,740 f/s
Powder temperature.....	84° F.
Weight of projectile.....	107 pounds
Latitude of battery.....	34° N.
Height of site.....	200 feet
Height of tide.....	0 feet

The following meteorological message was furnished the battery:

M	F	M	0	4
0	0	7	1	0
1	0	7	1	1
2	0	8	1	2
3	0	9	1	2
4	0	9	1	3

0	9	3	0	4
9	8	1	8	6
9	8	0	8	6
9	7	9	8	8
9	7	9	9	1
9	8	0	9	1

From part 2, table A, page 18, column 8, the maximum ordinate of the trajectory at 9,400 yards is 752 feet. The proper line of the meteorological message to be used is thus line 2 (p. XIII).

a. Range effects. (1) *Height of site* (pt. 2, table B, p. 32).

Height of target (feet)	Target below gun Map range (yards)		
	9,000	9,400	9,500
-200	+569	+522	+510

Effect = +522 yards

(2) *Weight of projectile* (pt. 2, table D, p. 47).

107 - 105 = 2 pounds

Decrease in weight = 2 percent

Range	Variation in weight of projectile (percent)
	+2
9,000	-48
9,400	-47
10,000	-45

Effect = -47 yards

(3) *Muzzle velocity* (pt. 2, table Fb, p. 58).

Developed muzzle velocity (previous firings) at 70° F.....	2,740 f/s
Present powder temperature.....	84° F.
Effect in f/s of 84° F. (chart, p. 9).....	+10 f/s
Expected muzzle velocity (2,740 f/s + 10 f/s).....	2,750 f/s
Decrease in muzzle velocity from standard (2,800 f/s - 2,750 f/s).....	50 f/s

Range	Decrease in muzzle velocity (f/s)
	50
9,000	-273
9,400	-282
10,000	-295

Effect = -282 yards

(4) *Density* (pt. 2, table Ga, p. 60). If any difference in altitude exists between the m.d.p. and the battery served by the message, consideration must be given to correcting the density listed in the message in accordance with the following formula:

0.3 percent = *decrease* in air density for each 100-foot *increase* in altitude.

0.3 percent = *increase* in air density for each 100-foot *decrease* in altitude.

Ballistic density at m.d.p. (line 2, meteorological message).....	97.9 percent
Altitude of m.d.p. (first line of meteorological message).....	400 feet
Altitude of battery.....	200 feet
Difference in altitude.....	200 feet

Since the battery is 200 feet *below* the m.d.p., the density is increased by 0.6 percent. The correct density for this firing is thus 97.9 percent + 0.6 percent = 98.5 percent, or a decrease of 1½ percent from a standard of 100 percent.

Range	Decrease in air density (percent)		
	1	1.5	2
9,000	+30	-----	+60
9,400	+32	+49	+65
10,000	+36	-----	+72

Effect = +49 yards

(5) *Temperature* (pt. 2, table H, p. 64). Line 2 of the meteorological message lists the temperature as 88° F. However, the 200-foot difference in altitude between the m.d.p. and battery must be considered in accordance with the following formula:

$1/5^{\circ}$ F. = decrease in temperature for each 100-foot increase in altitude.

$1/5^{\circ}$ F. = increase in temperature for each 100-foot decrease in altitude.

$2 \times 1/5^{\circ}$ F. = $2/5^{\circ}$ F. which, being less than $1/2^{\circ}$ F., may be disregarded.

The temperature for this firing is thus 88° F.

Range	Air temperature (degrees F.)		
	80	88	90
9,000	-52	-----	-75
9,400	-56	-75	-80
10,000	-61	-----	-88

Effect = -75 yards

(6) *Wind.*

Wind azimuth (line 2)..... 800 mils

Target azimuth..... 90° (N.) or 1600 mils (N.)

To determine the chart direction of the wind, the azimuth of the plane of fire (target azimuth) must be subtracted from the wind azimuth, 6400 mils being added to the latter if necessary.

Wind azimuth.....	800 mils
	+6400 mils
Wind azimuth.....	7200 mils
Target azimuth.....	-1600 mils
Chart direction of wind.....	5600 mils

Pages 2 and 3 (FT 6-E-2) contain the wind component chart. Since the wind velocity from line 2 equals 12 mph, the lateral and range components for a 6-mph wind should be determined and multiplied by 2. Entering the wind velocity chart with 5600 mils, a 6-mph wind has a lateral or deflection component of 4.3 mph and a range component of 4.3 mph. The range wind component is thus $2 \times 4.3 \text{ mph} = 8.6$ or 9 mph. The chart indicates that in this quadrant the wind diminishes the range and carries the projectile to the right. The range and deflection components should thus be expressed:

Range.....	-9 mph
Deflection.....	R 9 mph

Part 2, table Ib, page 66, lists the effects on range of a head wind.

Range	Head wind (miles per hour)		
	5	9	10
9,000	-8	-16
9,400	-9	-16	-18
10,000	-11	-21

Effect = -16 yards

(7) *Rotation of the earth* (pt. 2, table E, pp. 51 and 52).

Map range to target.....	9,400 yards
Azimuth of target.....	90° (N.)
Latitude of battery.....	34° N.

Range	Azimuth	Latitude		
		30°	34°	40°
9,000	90°	+57	+51
9,400	90°	+58	+56	+52
10,000	90°	+59	+53

Effect = +56 yards

(8) *Summation.*

	Effects (yards)	
	Plus	Minus
Height of site.....	522
Weight of projectile.....		47
Muzzle velocity.....		282
Density.....	49
Temperature.....		75
Wind.....		16
Rotation of earth.....	56
Totals.....	627	420
Combined effect.....	207
Combined correction.....		207
Map range.....		9,400
Corrected range (9,193 yards).....		9,190
Q.E. for corrected range ¹ (to nearest mil).....		86 mils

¹ The quadrant elevation corresponding to 9,193 yards is found by interpolation (col. 2, p. 18).

Range	Q.E. (mils)
9,100.....	84.8
9,193.....	86.1
9,200.....	86.2

b. Direction effects. (1) *Wind* (pt. 2, table J, p. 67).

Corrected range (nearest 100 yards)..... 9,200 yards
 Lateral wind component (previously determined)..... R 9 mph

Range	Cross-wind effect (degrees) (mph)		
	0	9	10
9,000	0	R 0.10
9,200	0	R 0.09	R 0.10
10,000	0	R 0.12

Effect = R 0.09°

(2) *Drift* (pt. 2, table A, p. 19).

Range	Deflection due to drift
9,000	R 0.10°
9,200	R 0.10°
9,500	R 0.10°

Effect = R 0.10°

(3) *Rotation of the earth* (pt. 2, table K, pp. 71 and 72).

Range	Azimuth	Deflection effect in mils		
		Latitude		
		30° N.	34° N.	40° N.
9,000	90°	R 0.4	R 0.6
9,200	90°	R 0.4	R 0.5	R 0.6
10,000	90°	R 0.5	R 0.6

$$\text{Effect} = R 0.5 \text{ mil} = R 0.03^\circ$$

(4) *Summation.*

	Effects	
	Right	Left
Wind.....	0.09°
Drift.....	0.10°
Rotation of earth.....	0.03°
Combined effect = R 0.22°.....	R 0.22°
Combined correction = L 0.22°.....	L 0.22°
Uncorrected azimuth = 270.00°.....	270.00°
Corrected azimuth.....	269.78°

25. 155-MM GUN BATTERY. (Superseded.) A 155-mm gun battery is equipped with guns M1A1, firing shell HE M101 with fuze P.D. M51, normal charge. (FT 155-S-2.) Assuming the following data, determine the corrected quadrant elevation and azimuth. (Page references in the problem refer to FT 155-S-2, 1944.)

Map range.....	9,500 yards
Azimuth of target..... 225° (S.) =	45° (N.)
Height of site.....	300 feet
Height of tide.....	+15 feet
Muzzle velocity (previous firings).....	2,080 f/s

Powder temperature..... 66° F.
 Weight of projectile..... 5 sq.
 Latitude of battery..... 44° N.

The following meteorological message was furnished the battery:

M	F	T	0	5
0	2	0	1	7
1	1	8	1	5
2	1	6	1	4
3	1	6	1	2
4	1	4	1	4
5	1	2	1	4

0	8	0	0	4
0	3	7	7	5
0	3	6	7	5
0	3	4	7	7
0	3	4	8	0
0	3	5	8	0
0	3	7	8	6

From page 20, column 10, the proper line of the meteorological message is line 3.

a. Range effects. (1) *Height of site* (p. XV). Since the firing tables for 155-mm guns do not contain tables for *target above gun* or *target below gun*, the procedure for obtaining the height of site correction is different from that used in the preceding problem. The method used consists of determining the quadrant angle of site trigonometrically and adding the complementary angle of site. The complementary angle of site is obtained by multiplying the value obtained in table A, column 13 or 14, of the firing tables by the quadrant angle of site. This results in an angular correction which is added algebraically to the quadrant elevation corresponding to the range corrected for all nonstandard conditions except height of site. The difference in elevation between the target and the gun is equal to the altitude of the battery minus the height of tide.

Altitude of battery.....	300 feet
Height of tide.....	15 feet
	<u>285 feet or 95 yards</u>

The tangent of the angle of site is therefore 95/9500 or 0.0100. The angle of site is found by the following interpolation (table LV, TM 5-236).

<i>Mils</i>	<i>Tangent</i>
10	0.00980
10.2	0.01000
11	0.01080

Angle of site = -10.2 mils

Complementary angle of site for 1-mil angle of site at 9,500 yards.....	-0.02 mil
For -10.2 mils (10.2×-0.02).....	-0.2 mil (0.204 mil)
Angle of site.....	-10.2 mils
Complementary angle of site.....	<u>-0.2 mil</u>
Corrected angle of site.....	-10.4 mils

See (8) for manner of applying this correction.

(2) *Weight of projectile.*

Effect of increase of 1 sq. (p. 21, col. 15)....	-9 yards
Effect of weight of projectile.....	-9 yards
	<u>Effect = -9 yards</u>

(3) *Muzzle velocity.*

Developed muzzle velocity (previous firings) at 70° F.....	2,080 f/s
Present powder temperature.....	66° F.
(See pt. 2a, table B, p. 30.)	

Powder temperature	Change in velocity (f/s)
60	-7
66	-3
70	0

Expected muzzle velocity at 66° F. (2,080 f/s - 3 f/s).....	2,077 f/s
Change in muzzle velocity (decrease) (2,100 f/s - 2,077 f/s).....	23 f/s
Effect of +1 f/s at 9,500 yards (p. 21, col. 16).....	+6.7 yards
Effect of +23 f/s at 9,500 yards (6.7 × 23).....	+154.1 yards
Effect of 23 f/s decrease in muzzle velocity.....	-154 yards
	Effect = -154 yards

(4) *Density.*

Altitude of m.d.p.....	500 feet
Altitude of battery.....	300 feet
Altitude difference.....	200 feet
Density from meteorological mes- sage.....	103.4 percent
Correction for altitude difference (p. 10).....	+0.6 percent
Corrected density.....	104 percent
Effect of 1 percent increase of den- sity at 9,500 yards (p. 21, col. 19)..	-37 yards
Effect of 4 percent increase of den- sity (100 percent standard).....	-148 yards
	Effect = -148 yards

(5) *Temperature.*

Temperature from line 3 of the mete- orological message.....	80° F.
Correction for altitude difference +0.4° F. (p. 10) disregarded as it is less than +0.5° F.	
Effect of 1° F. increase in temperature (p. 21, col. 17).....	-1.9 yards
Effect of 21° F. increase in temperature..	-39.9 yards
	Effect = -40 yards

(6) *Wind.*

Wind azimuth.....	1600 mils
Target azimuth (N.).....	-800 mils
Chart direction of wind.....	<u>800 mils</u>

Range wind for a 1-mph wind with an 800-mil chart direction of wind = -0.71 mph (p. 9). For a 12-mph wind, 12×-0.71 mph = -8.52 mph or -9 mph (to the nearest mile).

Range effect of a rear wind of 1 mph = $+4.3$ yards (p. 21, col. 18); range effect for a head wind of 1 mph = -4.3 yards. Range effect for a head wind of 9 mph = -39 yards. Effect = -39 yards.

(7) *Rotation of the earth* (see pt. 2a, table D, pp. 36 and 37).

Map range to target.....	9,500 yards
Azimuth of target.....	45° (N.) = 800 mils (N.)
Latitude of battery.....	44° N.

Range	Azimuth	Latitude		
		40°	44°	50°
8,000	800	+21	+18
9,500	800	+22	+21	+19
10,000	800	+23	+19

Effect = $+21$ yards

(8) *Summation.* The following table includes summation of:

(a) All range effects except the effect for height of site.

(b) Angular correction for height of site.

	Effects (yards)	
	Plus	Minus
Weight of projectile.....		9
Muzzle velocity.....		154
Density.....		148
Temperature.....		40
Wind.....		39
Rotation of earth.....	21	
Totals.....	21	390
Combined effect.....		369
Combined correction.....	369	
Map range.....	9,500	
Corrected range (less height of site).....	9,869	
Corresponding quadrant elevation.....	203.7	
Height of site correction.....		10.4 mils
Quadrant elevation (to nearest mil).....	193 mils (193.3 mils)	

NOTE. The quadrant elevation corresponding to 9,870 yards is found by interpolation (col. 2, p. 20).

Range	Q.E. (mils)
9,800.....	201.2
9,870.....	203.7
9,900.....	204.8

b. Direction effects. (1) Wind.

Cross-wind component for 1 mph (chart direction of wind is 800 mils).....	L 0.71 mph
For 12 mph.....	L 9 mph (L 8.52)
Deflection effect of 1 mph at 9,500 yards (p. 20, col. 12)....	L 0.4 mil
Deflection effect of 9 mph.....	L 3.6 mils
	Effect = L 3.6 mils

(2) Drift (p. 20, col. 11).

Drift effect for 9,500 yards.....	R 3 mils
	Effect = R 3 mils

(3) Rotation of the earth (pt. 2a, table E, pp. 44 and 45).

Range	Azimuth	Deflection effect in mils		
		Latitude		
		40° N.	44° N.	50° N.
8,000	800	R 0.7	R 0.8
9,500	800	R 0.8	R 0.9	R 1.0
10,000	800	R 0.9	R 1.1

Effect = R 0.9 mil

(4) *Summation.*

	Effects	
	Right	Left
Wind.....		3.6
Drift.....	3	
Rotation of earth.....	0.9	
Total.....	3.9	3.6
Combined effect, mils.....	0.3	
Combined effect, degrees.....	0.02	
Combined correction.....		0.02
Uncorrected azimuth.....		225.00° (S.)
Corrected azimuth.....		224.98° (S.)

26. 16-INCH GUN BATTERY. (Superseded.) A 16-inch gun battery, Mk. II (Navy), is to fire, using projectile, AP, 2,240-lb., Mk. XI, full charge (FT 16-E-1). With the following data assumed, compute the quadrant elevation and the corrected azimuth. (Page references in the problem refer to pages in FT 16-E-1, 1942.)

Map range.....	22,000 yards
Azimuth of target.....	240° (S.)
Muzzle velocity (powder tag).....	2,645 f/s
Powder temperature.....	74° F.
Height of site.....	200 feet
Height of tide.....	+20 feet
Latitude of battery.....	44° N.

The following meteorological message was furnished the battery:

M	F	M	0	3
0	2	1	1	4
1	2	1	1	4
2	2	2	1	5
3	2	2	1	6
4	2	3	1	6
5	2	4	1	6
6	2	4	1	6
7	2	5	1	8

1	1	3	0	5
9	6	9	8	9
9	6	8	8	9
9	6	6	9	1
9	6	6	9	4
9	6	7	9	4
9	6	9	0	0
9	7	1	0	0
9	7	3	0	0

From page 84, column 8, the maximum ordinate at 22,000 yards is 4,154 feet. The proper line of the meteorological message to be used is therefore line 4 (p. XV).

a. Range effects. (1) *Height of site* (pt. 2b, table B, p. 102).

Altitude of battery.....	200 feet
Height of tide (subtract).....	20 feet
Gun above target.....	180 feet

Height of target (feet)	Target below gun Map range 22,000 (yards)
-180	+203

Effect = +203 yards

(2) *Weight of projectile* (table D, p. 115). Because of the small weight tolerance of ± 6.5 pounds for the 2,240-pound AP projectile Mk. XI, the projectile weight effect on range is negligible at all ranges.

(3) *Muzzle velocity* (pt. 2b, table Fa, p. 124).

Muzzle velocity (powder tag) at 70° F.....	2,645 f/s
Present powder temperature.....	74°
Effect in f/s of 74° F. (chart, p. 9).....	+7 f/s
Expected muzzle velocity (2,645 f/s + 7 f/s)	2,652 f/s
Increase in muzzle velocity over standard (2,652 f/s - 2,650 f/s).....	2 f/s

Range	Increase in muzzle velocity (f/s)		
	0	2	10
22,000	0	+28	+142

Effect = +28 yards

(4) *Density* (pt. 2b, table Ga, p. 132).

Altitude of m.d.p.....	300 feet
Altitude of battery.....	200 feet
Altitude difference.....	100 feet
Correction for altitude difference.....	+0.3 percent
Corrected density 96.7 percent (from meteorological message) + 0.3 per- cent = 97 percent.	
Effect of 3 percent (100 percent - 97 percent) decrease from standard at 22,000 yards.....	+174 yards

Effect = +174 yards

(5) *Temperature* (pt. 2b, table H, p. 140). The correction in temperature because of altitude difference between the meteorological datum plane and battery is less than 0.5° F. and may be disregarded.

Range	Air temperature		
	90°	94°	100°
22,000	-140	-157	-182

Effect = -157 yards

(6) *Wind.*

Ballistic wind azimuth.....	2300 mils
Ballistic wind velocity.....	16 mph
Target azimuth in degrees.....	240° (S.) or 60° (N.)
Target azimuth in mils (angular conversion table, p. 6).....	1100 mils (1067 mils)
Ballistic wind azimuth.....	2300 mils
Target azimuth.....	-1100 mils
Chart direction of wind.....	1200 mils

Entering the wind component chart on pages 2 and 3, find the range wind component for a 16-mph wind. The range wind component for an 8-mph wind is -3 mph; for a 16-mph wind it is 2×-3 mph = -6 mph. The effects in yards of range due to head wind are listed in part 2b, table Ib, page 144.

Range	Head wind (mph)		
	5	6	10
22,000	-20	-24	-40

Effect = -24 yards

(7) *Rotation of the earth* (pt. 2b, table E, pp. 120, 121).

Map range to target.....	22,000 yards
Azimuth of target.....	60° (N.)
Latitude of battery.....	44° N.

Range	Azimuth	Latitude		
		40°	44°	50°
22,000	60°	+109	+102	+92

Effect = +102 yards

(8) *Summation.*

	Effects (yards)	
	Plus	Minus
Height of site.....	203
Muzzle velocity.....	28
Density.....	174
Temperature.....	157
Wind.....	24
Rotation of earth.....	102
Totals.....	507	181
Combined effect.....	326
Combined correction.....	326
Map range.....	22,000
Corrected range (21,674 yards).....	21,670
Q.E. for corrected range (see below).....	214 mils

NOTE. *Q.E. for corrected range* (pt. 2b, table A, p. 84).

Range	Q.E. (mils)
21,600	212.6
21,670	213.6 (214.0)
21,700	214.0

b. Direction effects. (1) *Wind* (pt. 2b, table J, p. 146).

Chart direction of wind..... 1200 mils
 Deflection wind component for 16-mph
 wind (chart, pp. 2 and 3)..... L 15 mph

Range	Cross-wind (mph)		
	10	15	20
21,000	L 0.08°	L 0.16°
21,700	L 0.08°	L 0.13°	L 0.17°
22,000	L 0.08°	L 0.17°

Effect = L 0.13°

(2) *Drift* (pt. 2b, table A, p. 85).

Range	Deflection due to drift
21,500	R 0.45°
21,700	R 0.47°
22,000	R 0.50°

Effect = R 0.47°

(3) *Rotation of the earth* (pt. 2b, table K, pp. 152 and 153).

Corrected range to target..... 21,670 yards
 Azimuth of target..... 60° (N.)
 Latitude of battery..... 44° N.

Range	Azimuth	Deflection effects in mils		
		40° N.	44° N.	50° N.
20,000	60°	R 1.2	R 1.3	R 1.5
21,700	60°	-----	R 1.4	-----
22,000	60°	R 1.3	R 1.4	R 1.6

Effect = R 1.4 mils or R 0.08°

(4) *Summation.*

	Effects	
	Right	Left
Wind.....		0.13°
Drift.....	0.47°	
Rotation of earth.....	0.08°	
Totals.....	0.55°	0.13°
Combined effect.....	0.42°	
Combined correction.....		0.42°
Uncorrected azimuth.....		240.00° (S.)
Corrected azimuth.....		239.58° (S.)

* * * * *

52. GENERAL. a. Cant is the * * * angles of inclination less than 4° (**app. V**).

* * * * *

95. OBSERVATION OF FIRE. Observation of fire should be conducted * * * various systems used. Camera records carefully taken from a vessel near the target will be most reliable **where the target shifts less than 10 yards throughout a practice.** To

aid in the computation of camera records, the location of the target vessel at the instant of each splash is obtained by horizontal base or other position finding system (TM 4-235 discusses the computation of camera records). If a chronograph * * * must be taken into consideration.

* * * * *

97. EXAMPLE. (Superseded.) A battery of 155-mm guns M1A1, using shell H.E. M101 with fuze P.D. M51, Supercharge (F'T 155-S-2), is to be fired for calibration at a range of 12,000 yards. The best known muzzle velocities are 2,795; 2,788; 2,760; and 2,767 for guns Nos. 1, 2, 3, and 4 respectively. The target is anchored at a range of 12,000 yards and located in such a position in the field of fire that the ranges from the four guns to the target are approximately equal and no correction for range difference is necessary. The azimuth from the directing point midway between guns Nos. 1 and 2 is 160° . The following meteorological message was received just prior to the firing.

M	F	M	0	0
0	3	7	0	9
1	3	8	2	4
2	3	8	2	5
3	3	8	2	5
4	3	9	2	4
5	4	1	2	0
6	4	1	2	0

0	9	3	0	4
9	5	2	8	5
9	5	5	8	5
9	5	8	8	8
9	6	0	9	0
9	6	2	9	0
9	6	4	9	5
9	7	1	9	5

The following data are assumed:

Map range..... 12,000 yards
 Azimuth of target..... 160° (from south)— 340°
 (from north)

Height of site.....	20 feet
Tide.....	0
Muzzle velocities (from previous firings).....	No. 1 gun—2,795 f/s No. 2 gun—2,788 f/s No. 3 gun—2,760 f/s No. 4 gun—2,767 f/s
Powder temperature.....	50° F.
Average weight of pro- jectiles.....	5 sq.
Latitude.....	40° N.

a. Range corrected for a change in muzzle velocity due to temperature of powder.

	Gun No. 1	Gun No. 2	Gun No. 3	Gun No. 4
Assumed muzzle velocity (from previous firings) (f/s).....	2,795	2,788	2,760	2,767
Correction for powder temperature of 50° F. (f/s).....	-17	-17	-17	-17
Muzzle velocity corrected for powder temperature (f/s).....	2,778	2,771	2,743	2,750
Standard muzzle velocity (f/s).....	2,800	2,800	2,800	2,800
Difference in corrected muzzle velocity from standard (f/s).....	-22	-29	-57	-50
Muzzle velocity effect (yards).....	-125	-165	-325	-285
Muzzle velocity correc- tion (yards).....	+125	+165	+325	+285
Map range (yards).....	12,000	12,000	12,000	12,000
Range corrected for change in muzzle veloc- ity due to powder tem- perature (yards).....	12,125	12,165	12,325	12,285

b. Range correction due to meteorological conditions: Line 3 of meteorological message is used.

(1) Wind

Wind azimuth	= 3800 mils	= 10200 mils
Target azimuth	=	-6044 mils
Chart direction		4156 mils
of wind.		or 4200 mils

Range effects
(in yards)

	Plus	Minus
Range component for wind of 25 mph = 14 mph.....	70	
(2) Temperature (elasticity) for 90° F. = -89.9.....		90
(3) Air density.....	216	
(4) Weight of projectile.....		-1
(5) Rotation of earth.....		17
(6) Totals.....	286	108
(7) Combined effect.....	178	
(8) Combined correction.....		178

c. Range corrected for nonstandard ballistic conditions:

	Gun No. 1	Gun No. 2	Gun No. 3	Gun No. 4
Range corrected for change in muzzle velocity (yards).....	12,125	12,165	12,325	12,285
Meteorological correction (yards).....	-178	-178	-178	-178
Range corrected for change in muzzle velocity and meteorological conditions (yards).....	11,947 or 11,950	11,987 or 11,990	12,147 or 12,150	12,107 or 12,110
Corresponding elevation (mils).....	141.9	142.8	146.1	145.2
Height of site correction (mils).....	-.6	-.6	-.6	-.6
Elevation corrected for height of site (mils).....	141.3 or 141	142.2 or 142	145.5 or 146	144.6 or 145

TABLE A. *Splash Deviations (yards)*

Shot Number	Gun No. 1	Gun No. 2	Gun No. 3	Gun No. 4
1.....	+70			
2.....		+40		
3.....			-120	
4.....				+10
5.....	-80			
6.....		+20		
7.....			+20	
8.....				-30
9.....	+20			
10.....			+70	
11.....		-100		
12.....				-50
13.....		-40		
14.....	-20			
15.....			+90	
16.....				+10
17.....	+40			
18.....		-30		
19.....			+120	
20.....				+120
21.....			-40	
22.....				+20
23.....		+70		
24.....	+90			
25.....			-70	
26.....	0			
27.....		+60		
28.....				-10
29.....	-10			
30.....		0		
31.....			0	
32.....				+40
Total (algebraic sum).....	+110	+20	+70	+110
Mean of total deviation.....	+14	+3	+9	+14

d. Splash deviations. No means of obtaining camera records being available, the horizontal base position finding system of the battery is employed to determine splash deviations. As each shot is fired, simultaneous azimuth readings of the target are taken from the two base-end stations. These azimuths are set on the plotting board and the resultant target position located and plotted. The azimuths of the splashes are read from the base-end stations, set on the plotting board, and the resultant splashes located and plotted. By subtracting the range to the splash and the range to the target for each particular shot, the range deviation is determined. This deviation obtained from the plotting board is recorded in table A for each shot. As the target shifted position less than 10 yards throughout the practice, target range in this example remains the same for all shots.

e. New ballistic data. The muzzle velocity developed during the firing is determined from the stripped deviation of the centers of impact of each gun. During the firing, however, another meteorological message is determined, so that the ballistic data are different from those used for the firing. The meteorological message received at this time is as follows:

M	F	M	0	0
0	3	9	0	9
1	3	8	1	5
2	3	9	1	7
3	3	9	1	9
4	3	9	1	9
5	4	1	1	8
6	4	1	1	7

1	2	3	0	4
9	5	2	8	5
9	5	3	8	5
9	5	7	8	8
9	6	0	9	0
9	6	2	9	0
9	7	0	9	5
9	8	1	9	5

Aside from a change in ballistic data, the data are exactly the same as those used for calculating the previous effects. The difference in total ballistic effects due to the new ballistic conditions is calculated and stripped out of the deviations in order to determine the difference in muzzle velocity. The developed muzzle velocity is determined by applying the difference in muzzle velocity to the muzzle velocity originally assumed.

f. Range correction due to meteorological conditions: Line 3 of meteorological message is used.

(1) Wind

Wind azimuth	= 3900 mils	= 10300 mils
Target azimuth	=	<u>-6044 mils</u>
Chart direction		4256 mils
of wind.		or 4300 mils

Range effects
(in yards)

	Plus	Minus
Range component for wind of 19 mph = 9 mph.....	45
(2) Temperature (elasticity) for 90° F.....	90
(3) Air density.....	216
(4) Weight of projectile.....	1
(5) Rotation of earth.....	17
(6) Totals.....	261	108
(7) Combined effect.....	+153
(8) Combined correction.....	-153

g. Range corrected for nonstandard ballistic conditions:

	Gun No. 1	Gun No. 2	Gun No. 3	Gun No. 4
Range corrected for change in muzzle velocity (yards).....	12,125	12,165	12,325	12,285
Meteorological correction (yards).....	-153	-153	-153	-153
Range corrected for change in muzzle velocity and meteorological conditions (yards).....	11,972 or 11,970	12,012 or 12,010	12,172 or 12,170	12,132 or 12,130
Corresponding elevation (mils).....	142.3	143.2	146.5	145.7
Height of site correction (mil).....	-.6	-.6	-.6	-.6
Elevation corrected for height of site (mils).....	141.7 or 142	142.6 or 143	145.9 or 146	145.1 or 145

h. In the following table (table B), the stripped deviation and difference in muzzle velocity are determined, thereby deriving the developed muzzle velocity.

TABLE B. *Derivation of developed muzzle velocity*

Line	Item	Gun No. 1	Gun No. 2	Gun No. 3	Gun No. 4
1..	Uncorrected range (yards).....	12,000	12,000	12,000	12,000
2..	Total correction (difference between uncorrected range and range corrected for "met" message received during firing) (yards).....	-30	+10	+170	+130
3..	Corrected range (yards)...	11,970	12,010	12,170	12,130
4..	Corrected elevation (mils).....	142	143	146	145
5..	Elevation used for firing (mils).....	141	142	146	145
6..	Effect of difference in elevation at 12,000 (yards).....	+47	+47	0	0
7..	Mean deviation (yards)...	+14	+3	+9	+14
8..	Stripped deviation (6) + (7) (yards).....	+61	+50	+9	+14
9..	Muzzle velocity variation (f/s) corresponding to deviation in (8).....	+11	+9	+2	+2
10..	Assumed muzzle velocity (f/s) (from previous firings).....	2,795	2,788	2,760	2,767
11..	Developed muzzle velocity (f/s) (9) + (10)...	2,806	2,797	2,762	2,769

i. Application of calibration correction. The next problem is to determine how to apply a calibration correction. It is not practicable to send

separate data to each of four guns. However, it is practicable to send a separate set of data to each platoon of two guns. This latter procedure might necessitate regrouping the guns. In the problem under discussion, the muzzle velocities of registers Nos. 1 and 2, and registers Nos. 3 and 4, are nearly equal. These are consequently grouped as tactical numbers 1, 2, 3, and 4 respectively.

(1) To apply the correction, an additional pointer on the percentage corrector is chosen for the use of the second platoon. The average muzzle velocity for the first platoon is:

$$\frac{2,806 + 2,797}{2} = 2,802 \text{ f/s}$$

and for the second platoon it is:

$$\frac{2,762 + 2,769}{2} = 2,766 \text{ f/s}$$

(2) The first platoon was chosen as the reference platoon and the second as the test platoon. The difference in muzzle velocity for which a correction is necessary is 36 f/s. To determine the correct range percentage to apply, it is now necessary to tabulate for each 2,000 yards the correction necessary in yards and percent of range. The following tabulation (p. 33) and graph (fig. 39) show a comparison between the effects in yards of range for a decrease in muzzle velocity of 36 f/s, and the range effects in yards of corrections of 1.6 percent, 1.7 percent, and 1.8 percent on the percentage corrector. Figure 39 discloses that 1.6 percent of the range will give the least error throughout the entire range of the gun. A range correction of up 1.6 percent is then applied to the second platoon by attaching a second read pointer to the read pointer for the first platoon. The second pointer is offset by a distance equal to 316 on the correction scale.

Range	Range effects due to 36 f/s decrease in MV		Range effects in yards		
	Yds.	% Ra.	1.6%	1.7%	1.8%
2,000	47	2.35	32	34	36
4,000	94	2.35	64	68	72
6,000	130	2.17	96	102	108
8,000	158	1.98	128	136	144
10,000	184	1.84	160	170	180
12,000	205	1.71	192	204	216
14,000	230	1.64	224	238	252
16,000	252	1.58	256	272	288
18,000	274	1.52	288	306	324
20,000	299	1.50	320	340	360
22,000	317	1.44	352	374	396
24,000	335	1.40	384	408	432
25,000	349	1.40	400	425	450

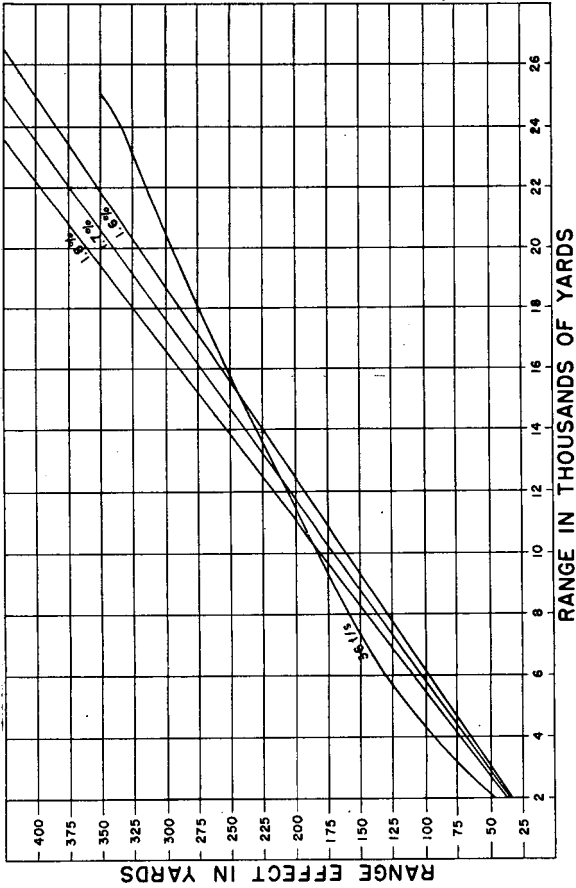

Figure 39. Comparison of range effects based on FT 155-S-2.

98. EXAMPLE. (Superseded.) In this problem, a sequel to the one preceding, it is assumed that several months have elapsed. A record, which included data on the calibration firing already shown, was kept by the battery during this time. The record reveals that the gun with register No. 2 was chosen as the reference piece and that muzzle velocity differences were computed. (Muzzle velocity difference is the variation from the reference piece of each of the other guns with no reference to normal muzzle velocity. The correction for the variation of the muzzle velocity of the reference piece from the normal muzzle velocity is made on the range correction board.)

a. Problem. *What mean velocity differences may be determined from these data?*

RECORD OF VELOCITY DIFFERENCES

Register No.	Range	No. 1		No. 2		No. 3		No. 4	
		Shots fired	Vel. diff.	Shots fired	Vel. diff.	Shots fired	Vel. diff.	Shots fired	Vel. diff.
<i>Calibration</i>									
15 July 1943.....	12,000	8	+9	8	0	8	-35	8	-28
<i>Target practice</i>									
10 Sept. 1943.....	11,200	8	+10	8	0	10	-34	10	-28
2 June 1944.....	13,100	10	+11	10	0	12	-32	12	-27
6 Feb. 1944.....	12,800	7	+7	7	0	8	-38	8	-21

b. Solution. As there can be no exact solution to this problem, the following is offered as one means of attaining a satisfactory solution. The first decision entailed a choice of the firings used in the computation. Since all the firings were at approximately the same range, it was decided that all should be used. Next came the matter of

weighting factors. The following facts were considered in making the decision: that whereas the rate of fire of this type of gun ordinarily makes pointing not as accurate as is desired for calibration purposes, the results of these target practices were excellent; that the shots were well grouped and close to the target, showing that the pointing was good enough to permit use of the data. Therefore, it was decided to give the calibration firing a weight of three, and each target practice a weight of one. Each practice was weighted according to the square root of the number of rounds fired. The calculation of the weighted means was made as follows:

Gun register No. 1—

$$\frac{(3 \times \sqrt{8} \times 9) + (\sqrt{8} \times 10) + (\sqrt{10} \times 11) + (\sqrt{7} \times 7)}{3 \times \sqrt{8} + \sqrt{8} + \sqrt{10} + \sqrt{7}} = \frac{158}{17} = 9 \text{ f/s}$$

Gun register No. 2—

Reference piece (no difference).

Gun register No. 3—

$$\frac{(3 \times \sqrt{8} \times -35) + (\sqrt{10} \times -34) + (\sqrt{12} \times -32) + (\sqrt{8} \times -38)}{3 \times \sqrt{8} + \sqrt{10} + \sqrt{12} + \sqrt{8}} = \frac{-623}{18} = -35 \text{ f/s}$$

Gun register No. 4—

$$\frac{(3 \times \sqrt{8} \times -28) + (\sqrt{10} \times -28) + (\sqrt{12} \times -27) + (\sqrt{8} \times -21)}{3 \times \sqrt{8} + \sqrt{10} + \sqrt{12} + \sqrt{8}} = \frac{-479}{18} = -27 \text{ f/s}$$

Guns with registers Nos. 1 and 2 were then grouped as the first platoon and guns with registers Nos. 3 and 4 were grouped as the second platoon. The first platoon had an average variation of muzzle velocity of $\frac{(+9) + (+0)}{2}$ or +5 f/s. The

second platoon had an average variation of $\frac{(-35) + (-27)}{2}$ or -31 f/s. The

second platoon developed an average of 36 f/s less muzzle velocity than the first platoon and a correction of -36 f/s was made for this.

* * * * *

107. THE M1910A1 AZIMUTH INSTRUMENT.

The M1910A1 azimuth instrument * * * a large splash occurs. **Axial spotting observers observe on the center of the splash; all other spotting observers observe on the edge of the splash nearest the battery.**

* * * * *

116. CLASSIFICATION OF FIRE.

* * * * *

c. Some batteries will be able * * * with the target in the hitting area. **Batteries opening at full rate will have trial-fire and fire-for-effect phases identical to those of batteries opening with deliberate fire** except that **in the former** there will be no delay for the application of corrections.

Example. (Added.) A 155-mm battery (4 guns) opens fire by salvo on a target at full rate and maintains full rate throughout. The PE is 0.5 percent. Two salvos fall between the determination of the correction and appearance of the correction in the sensings. Following is a tabulation showing the sensings obtained and corrections ordered:

<i>Salvo</i>	<i>Percentage corrector settings</i>	<i>Sensings</i>	<i>Correction ordered</i>
1.....	300.....	0000.....	280
2.....	300.....	0000.....	
3.....	300.....	0000.....	
4.....	280.....	0H00.....	275
5.....	280.....	00S0.....	
6.....	280.....	0000.....	
7.....	275.....	(Fire for effect starts at salvo 7. Start plotting on fire adjustment chart.)	

d. (Added.) Trial fire is usually conducted by firing at the target. However, in certain tactical situations trial fire may be directed at a fixed point in the water known as a trial shot point. This type of trial fire could be used where radar spot-

ting is employed, where more than one battery is to fire upon a single target, where difficulty in identifying splashes of individual batteries is likely, and where it is considered desirable to conduct trial fire before a target comes within range of a battery. A trial shot point for a battery should be visible from the battery spotting instrument(s) and, when possible, in a portion of the field of fire near an expected position of the target. All batteries using a trial shot point for trial fire should employ the trial-fire phase of the magnitude method of fire adjustment (par. 118). To accomplish this, the battery spotting system must be capable of furnishing the magnitudes of splashes.

* * * * *

123.1. FIRE ADJUSTMENT FOR AMTB BATTERIES. (Added.)

a. To meet the problem of range fire adjustment for AMTB batteries, a modified form of the bracketing method of fire adjustment is employed. As the speed required to determine and apply corrections in AMTB battery fire adjustment prohibits the use of a chart, the fire adjustment operator or range officer makes or orders corrections directly from the spotting sensings.

b. Lateral adjustment corrections are ordered by the lateral spotter.

NOTE. FM 4-15 discusses the determination and application of fire adjustment corrections for AMTB batteries.

* * * * *

[AG 300.7 (30 Mar 45)]

BY ORDER OF THE SECRETARY OF WAR:

OFFICIAL:

J. A. ULIO
Major General
The Adjutant General

G. C. MARSHALL
Chief of Staff

DISTRIBUTION:

AAF(2); AGF(40); ASF(2); T of Opns(5); Arm &
Sv Bd(1); Def Comd(5); Tech Sv(2) except 9(10);
HD(2); Sp Sv Sch(10); USMA(50); ROTC 4(1);
R 4(5); Bn 4(5); C 4(10).

For explanation of distribution formula, see
FM 21-6.

WAR DEPARTMENT FIELD MANUAL
FM 4-10

*This manual supersedes FM 4-10, 3 July 1940,
including C 1, 24 April 1942.*

COAST ARTILLERY

GUNNERY



WAR DEPARTMENT

20 MAY 1944

DISSEMINATION OF RESTRICTED MATTER.
The information contained in restricted documents and the essential characteristics of restricted material may be given to any person known to be in the service of the United States and to persons of undoubted loyalty and discretion who are cooperating in Government work, but will not be communicated to the public or to the press except by authorized military public relations agencies. (See also par. 23b, AR 380-5, 15 Mar 1944.)

*Army Field Printing Plant
The Coast Artillery School
Fort Monroe, Va.*

WAR DEPARTMENT,
WASHINGTON 25, D.C., 20 May 1944.

FM 4-10, Coast Artillery Field Manual, Gunnery,
is published for the information and guidance of
all concerned.

[A.G. 300.7 (29 Apr 44).]

BY ORDER OF THE SECRETARY OF WAR:

G. C. MARSHALL,
Chief of Staff.

OFFICIAL:

J. A. ULIO,
*Major General,
The Adjutant General.*

DISTRIBUTION:

As prescribed in paragraph 9a, FM 21-6:
Sv C (10); Dept (10); HD (1); Bn &
H 4 (5); C 4 (10); Technical Sv (2);
Arm & Sv Board (2); ROTC (1); Gen &
Sp Sv Sch (10) except CA ~~Sch (400)~~,
AAA Sch (200).

For explanation of symbols see FM 21-6.

CONTENTS

	Paragraphs	Page
CHAPTER 1. GENERAL	1-2	1
CHAPTER 2. FIRING TABLES.		
<i>Section I.</i> Ballistics	3-5	3
II. Trajectory and its elements	6-14	4
III. Explanation and use of firing tables	15-22	10
IV. Examples	23-26	23
CHAPTER 3. PROBLEMS RELATING TO POSITION.		
<i>Section I.</i> General	27-28	44
II. Minimum elevation	29-30	45
III. Minimum range	31-32	50
IV. Chart of field of fire....	33	61
CHAPTER 4. ACCURACY OF POSITION - FINDING METHODS.		
<i>Section I.</i> General	34-35	65
II. Horizontal base system.	36-37	69
III. Notes on accuracy of self - contained and vertical base systems.	38-40	71
IV. Accuracy of gun data computers and radar.	41-42	75
V. Observation with coincidence and stereoscopic range finders	43-45	76
VI. Observation with a depression position finder	46-48	80
VII. Plotting boards	49-51	85

CHAPTER 5. POINTING.	Paragraphs	Page
<i>Section I.</i> Cant	52-54	90
II. Compensating sight mounts	55-59	93
III. Selection of aiming points	60-65	104
 CHAPTER 6. ERRORS, PROBABILITY, AND DISPERSION.		
<i>Section I.</i> General	66	116
II. Definitions of errors....	67-68	116
III. Causes of errors.....	69-73	122
IV. Mathematics of proba- bility	74-77	128
V. Dispersion	78-79	130
VI. Curve of accidental errors	80-81	136
VII. Distribution of errors...	82-83	140
 CHAPTER 7. CALIBRATION.		
<i>Section I.</i> General	84-89	144
II. Application of correc- tions	90-92	146
III. Calibration fire	93-95	151
IV. Calculation of correc- tions	96-98	153
 CHAPTER 8. SPOTTING.		
<i>Section I.</i> General	99-100	166
II. Lateral spotting	101-102	167
III. Range spotting	103-105	167
IV. Accuracy of instruments	106-109	169
 CHAPTER 9. ADJUSTMENT OF FIRE.		
<i>Section I.</i> General	110-116	178
II. Magnitude method of range adjustment	117-120	184
III. Bracketing method of range adjustment	121-123	195
IV. Lateral adjustment	124-127	204
V. Adjustment of simulated fire	128-132	213

	Paragraphs	Page
<i>Appendix</i> I. Glossary		217
II. Effects of small errors when using horizontal base position - finding or two-station spotting system		219
III. Principles of vertical base position finding.....		227
IV. Effect of small errors when using self-con- tained range finder		239
V. Derivation of formula showing the effect of cant on pointing in direction		243
VI. Tables		246
VII. List of references		249
 INDEX		 250

CHAPTER 1

GENERAL

1. PURPOSE AND SCOPE. The purpose of this field manual is to present the basic principles of gunnery for seacoast artillery. It aims to acquaint Coast Artillery officers with the principles they must understand and apply in order to fire accurately at the enemy under unfavorable as well as favorable conditions. These basic principles are fixed, but their application varies with the instruments available, with the topography, and with the capabilities of the enemy. Discussed herein are firing tables and firing table problems, the manner in which errors and dispersion affect the accuracy of pointing and spotting, and the problem of adjustment of fire. This manual, however, does not aim to present an exhaustive study of ballistics.

2. MISSION OF SEACOAST ARTILLERY. a. Objective. The objective of seacoast artillery gunnery is to prevent hostile naval vessels from completing their mission. In most cases this requires the destruction or disabling of the vessels, but occasionally harassing fire forces the enemy to withdraw. The tactical employment of seacoast artillery is covered in FM 4-5 and will not be dealt with in this manual.

b. The problem. The problem confronting the

NOTE. For military terms not defined in this manual, see TM 20-205.

battery commander in the accomplishment of his share of the seacoast artillery mission involves—

(1) Determining the range, direction, and rate of travel of the target.

(2) Correcting this original data for atmospheric and other conditions that affect the flight of a projectile.

(3) Pointing and firing guns accurately.

(4) Determining the deviation or sense of the fall of shot.

(5) Adjusting the fire of the battery.

The importance of the accuracy of the first shots cannot be overemphasized. A premium, therefore, must be placed upon preparation for firing. Proper preparation includes the determination of the muzzle velocity to be expected from the combination of powder and projectile to be used.

c. Conditions to be expected. The battery commander must be prepared to engage hostile vessels under conditions favorable to the enemy, that is, during darkness and periods of poor visibility. He must also expect the enemy, when fired upon, to change course and vary speed. No battery can hope to destroy an obscured or maneuvering target without arduous hours of drill, painstaking attention to details, and an understanding of gunnery by the key men of the organization, officers and enlisted men alike.

CHAPTER 2

FIRING TABLES

Section I. BALLISTICS

3. GENERAL. Ballistics is the science of the motion of projectiles. It is the theoretical foundation on which must be based all improvements in the design of guns and ammunition leading to the increased power and efficiency of artillery. Ballistics is divided into two main branches: interior ballistics and exterior ballistics.

4. INTERIOR BALLISTICS. Interior ballistics is the study of the motion and the factors affecting the motion of a projectile while still in the bore of the gun. Its principal application is to determine how the weight of the projectile, the weight and rate of burning of the powder, and the dimensions of the gun affect the powder gas pressures and the velocity of the projectile at any point in the bore. Interior ballistics is of use principally in designing new weapons. To the practical artilleryman, those parts of the subject pertaining to muzzle velocity, maximum pressure, and factors governing erosion of the bore are of principal concern.

5. EXTERIOR BALLISTICS. Exterior ballistics is the study of the motion and the factors affecting the motion of a projectile after it has left the bore. It has practical application in the computing and compiling of firing tables and in the determining

of corrections to be applied to the firing data to offset the effect on the projectile of wind, air density, and other measurable factors.

Section II. TRAJECTORY AND ITS ELEMENTS

6. GENERAL. The trajectory is the path of the projectile from the muzzle of the gun to the first point of impact. The phrase, *elements of the trajectory*, is applied to the various features of the trajectory. (See fig. 1.) The elements most frequently referred to are defined in the following paragraphs.

7. INTRINSIC ELEMENTS. **a. Trajectory.** The curve described by the center of gravity of the projectile in flight.

b. Ascending branch. That portion of the trajectory described by the projectile while rising.

c. Descending branch. That portion of the trajectory described by the projectile while falling.

d. Origin. The center of the muzzle of the piece at the instant of departure.

e. Summit. The highest point on the trajectory.

f. Level point. The point on the descending branch of the trajectory at the same altitude as the origin.

g. Base of the trajectory. The straight line between the origin and the level point.

h. Maximum ordinate. Difference in altitude between the origin and the summit.

8. INITIAL ELEMENTS. **a. Line of elevation.** The prolongation of the axis of the bore when the piece is set.

b. Line of departure. The prolongation of the axis of the bore as the projectile leaves the muzzle of the gun. It is tangent to the trajectory at its origin.

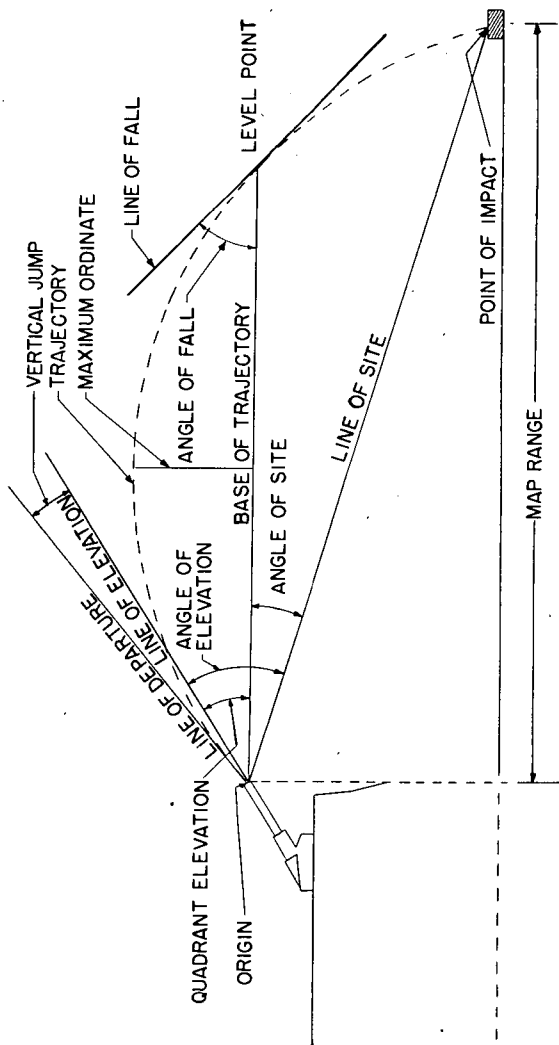

Figure 1. Elements of trajectory.

c. Line of site. The straight line between the origin of the trajectory and the target.

d. Plane of fire. The vertical plane containing the line of elevation.

e. Plane of departure. The vertical plane containing the line of departure.

f. Angle of elevation or elevation. The angle between the line of site and the line of elevation.

g. Angle of departure. The angle between the line of site and the line of departure.

h. Angle of site (ϵ). The angle between the line of site and the base of the trajectory.

i. Quadrant angle of elevation (ϕ) or quadrant elevation. The angle between the horizontal and the line of elevation.

j. Quadrant angle of departure (ϕ'). The angle between the horizontal and the line of departure.

k. Lateral jump. The horizontal angle between the plane of fire and the plane of departure.

l. Vertical jump. The difference between the angle of elevation and the angle of departure. It is positive if the angle of departure is greater than the angle of elevation.

9. TERMINAL ELEMENTS. **a. Point of impact.** The point where the projectile first strikes an object.

b. Line of fall. The line tangent to the trajectory at the level point.

c. Angle of fall (ω). The angle between the line of fall and the base of the trajectory.

10. OTHER ELEMENTS. **a. Muzzle velocity (MV or V).** Muzzle velocity or initial velocity is the velocity with which the projectile is assumed to leave the muzzle of the gun. It is the velocity of the projectile, measured at a distance from the muzzle, corrected for the theoretical loss in velocity during the travel from the origin of the

trajectory to the point of measurement, considering that during that travel the projectile has been acted upon only by air resistance and gravity.

b. Remaining velocity. The remaining velocity at any point of the trajectory is the actual velocity at that point.

c. Terminal velocity (V_ω). The remaining velocity at the level point.

d. Time of flight (t). The elapsed time from the instant the projectile leaves the muzzle to the instant of impact or to the instant of burst.

e. Range. The horizontal distance between two points, such as from the gun or directing point of a battery to the target.

f. Drift. The divergence of a projectile, due to its rotation and the resistance of air, from the plane of departure. It is usually expressed in angular units.

11. TRAJECTORY IN VACUO. One of the major forces acting on a projectile in flight is gravity. Assume that a projectile is fired in vacuo with a

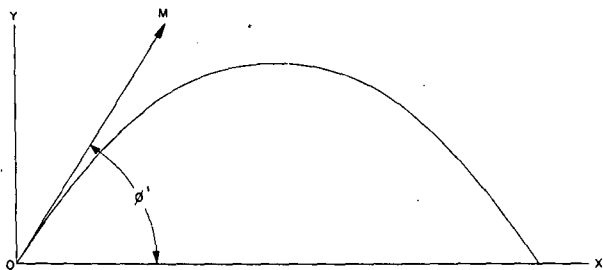

Figure 2. Trajectory in vacuo.

velocity at the muzzle of the gun of V feet per second in the direction OM , as shown in figure 2, and at a vertical angle (ϕ') from the horizontal.

Assume, in addition, that the force of gravity is constant and acts at right angles to the base of the trajectory throughout the flight of the projectile. During its flight the projectile is acted upon only by gravity and a study of the resultant trajectory reveals the following facts:

a. The trajectory is a parabola.

b. The trajectory is symmetrical in relation to the maximum ordinate; the ascending and descending branches are the same length and are traversed in the same time, and the angle of fall is the same as the quadrant angle of departure.

c. The trajectory depends on the initial velocity V and the quadrant angle of departure ϕ' only; the shape of the trajectory is independent of the shape and weight of the projectile.

d. Terminal velocity is the same as initial velocity.

e. Maximum range is attained at a quadrant angle of departure of 45° .

f. The trajectory lies in the plane of departure.

12. AIR RESISTANCE. It is obvious that for ballistic purposes the air resistance to a moving body is not, like gravity, a constant force, but that it increases with the speed of the body. Before the nature of the trajectory in air can be studied, it is necessary to determine by experiment the manner in which the resistance encountered by the projectile varies with the speed. There are many things that complicate the determination of the air resistance and its resulting reaction on a projectile. When a projectile is fired from a gun, it acquires a certain amount of kinetic energy. In overcoming air resistance, part of this energy is used up. This loss of energy may be mostly accounted for as follows:

a. Displacing a certain volume of air from the path of the projectile.

b. Overcoming the resistance to skin friction between the surface of the projectile and surrounding particles of air.

c. Formation of eddies around the projectile.

d. Formation of a partial vacuum in the rear of the projectile.

e. Setting up and overcoming a wave motion in the air.

f. Gyroscopic wobbling.

13. BALLISTIC COEFFICIENT C. The retardation formula in use at the present time for computing trajectories contains, among other factors, one called the *ballistic coefficient*, represented by the letter "C." This term represents a measure of the ability of the projectile to overcome air resistance and maintain its velocity. The ballistic coefficient is usually expressed as—

$$C = \frac{W}{id^2}$$

where W equals weight of the projectile in pounds, d equals diameter in inches, and i equals a coefficient dependent upon the shape of the projectile, location of rotating band, and observed characteristics of flight of the projectile. It has been found that these properties have considerable effect on the retardation.

14. TRAJECTORY IN AIR. Whereas the trajectory in vacuo depends only on the initial velocity and quadrant angle of departure (see par. 11), the equations of the trajectory in the air contain not only these factors but also factors based on the value of the ballistic coefficient, the rotation imparted to the projectile, and existing atmospheric conditions. As a result, there is considerable change in the characteristics of the trajectory, as may be seen from the following summary:

a. The trajectory is no longer a parabola.

b. The trajectory is no longer symmetrical: the descending branch is shorter, more curved, and takes longer to traverse than the ascending branch; and the angle of fall is larger than the quadrant angle of departure.

c. The trajectory no longer depends on the initial velocity and the quadrant angle of departure only; its shape is affected by the weight and shape of the projectile.

d. Terminal velocity is less than initial velocity.

e. Maximum range is not necessarily attained at a quadrant angle of departure of 45° .

f. The trajectory does not lie in the plane of departure because of drift. (See par. 21c.)

Section III. EXPLANATION AND USE OF FIRING TABLES

15. GENERAL. a. Some of the conditions under which firing takes place are constantly changing. The muzzle velocity, for example, varies according to the amount of wear of the bore, the powder lot, and the temperature of the powder; projectiles vary somewhat in weight and ballistic coefficient; and the continuously changing weather conditions produce variations in the density and wind structure of the atmosphere. Therefore, for each gun, two distinct types of data are required. One set shows the performance of the weapon when all conditions are normal; the second type of data gives the effects for certain definite variations from standard conditions. Firing tables present these data in a form convenient for use in computing firing data or in checking devices used in the calculation of firing data. The Ordnance Department computes and publishes these tables for each combination of gun and ammunition used

in the service. Standard Nomenclature List F-69 is the Ordnance Department's catalog listing the firing tables to be used with particular combinations of guns and ammunition.

b. In order to prepare firing tables, trajectories are computed for various quadrant elevations of a gun, and firings are conducted at the proving grounds with the gun at these elevations. Computed trajectories and results actually obtained in firings are compared, and computations are adjusted and tabulated. Data for other elevations are completed by interpolation. This tabulation sets forth the range-elevation relation for the gun and ammunition used in the firing and is the most exact of all the data included in the tables. Certain data desired cannot be obtained from measurements and consequently must be computed. In general, the principal elements now determined by measurements in proving ground tests are the muzzle velocity, quadrant angle of elevation, quadrant angle of departure, jump, range attained, and drift. The computed elements are the maximum ordinate, time of flight, angle of fall, and terminal velocity.

16. CONTENTS OF FIRING TABLES. The present standard firing tables are published in book form. The introduction contains general information about the gun, carriage, and ammunition; an explanation of the tables; an explanation of the meteorological message; an example of the use of firing tables in computing firing data. This introduction should be treated as a textbook and referred to freely to develop facility in using the tables. Part 1 contains data to be used with all combinations of projectile, fuze, and powder charge, and also data common to all firing tables such as wind component charts and conversion tables. Part 2 contains tables giving trajectory data and differential effects.

17. STANDARD BALLISTIC CONDITIONS. In order to compare the results of firings at different times and places and to take into account conditions that actually exist at the time and place of firing, range-elevation relations are constructed for certain assumed ballistic conditions called standard. Based on these assumed standard ballistic conditions, tables of differential effects are developed from which corrections may be determined to adapt the firing data to the non-standard conditions existing at the time of any firing. The most important of the standard ballistic conditions are based on the following assumptions:

- a. The earth is motionless.
- b. The gun and target are at the same altitude above sea level.
- c. Muzzle velocity for which the firing tables are constructed (that is, standard muzzle velocity) is actually developed.
- d. Powder temperature is 70° F.
- e. Weight of the projectile is as listed.
- f. There is no wind.
- g. Atmospheric temperature is 59° F. at the muzzle and varies with the altitude in a definite manner.
- h. Atmospheric density varies with the altitude according to certain fixed laws and is equal, at the gun, to that density obtaining when the temperature is 59° F., barometric pressure is 29.528 inches, and the air is 78 percent saturated with moisture.
- i. Drift (including lateral jump) is as determined by experimental firing.
- j. Vertical jump is as determined by experimental firing.

18. NECESSITY FOR CORRECTIONS DUE TO NONSTANDARD BALLISTIC CONDITIONS. Conditions at the gun position at the time of firing can never be exactly the same as the conditions assumed as standard. Thus the variations of exist-

ing conditions from standard must be determined and corrections applied to firing data. For this purpose, firing tables contain tables of differential effects which list the effects on range and direction of conditions departing from standard.

19. CORRECTIONS IN FIRING DATA. a. The calculation of firing data has as its purpose the determination of the corrected range and corrected azimuth (or deflection) from the guns to the target. As previously discussed, the procedure involves applying corrections in the uncorrected range and uncorrected azimuth (or deflection) for the nonstandard conditions existing at the time of firing. This process is accomplished by devices in the battery plotting room. However, in order to check the accuracy and performance of these devices, a thorough knowledge of how to calculate firing data by use of firing tables is necessary. By assuming typical conditions, firing data for a fixed target can be calculated deliberately by operation of the plotting room equipment and by use of the tables, and the two results compared. In order to avoid confusion, it must be remembered that the tables of differential effects are given with a plus or minus sign showing the *actual range effect* and that the *range correction* will always be opposite in sign from the effect. In some firing tables the lateral effects are given with a minus sign indicating an effect to the right, thus indicating a correction in the opposite direction. A failure to take effect in the proper direction because of confusion in signs will cause large errors in the computation of corrections. A knowledge of the conditions affecting range and direction is a prerequisite to intelligent use of the firing tables.

b. The conditions affecting range are—

- | | |
|---------------------------|----------------------|
| (1) Height of site. | (3) Muzzle velocity. |
| (2) Weight of projectile. | (4) Density. |

- (5) Temperature (elasticity).
 - (6) Wind.
 - (7) Rotation of the earth.
- c. The conditions affecting direction are—
- (1) Wind.
 - (2) Drift.
 - (3) Rotation of the earth.

20. CONDITIONS AFFECTING RANGE. a.

Height of site. (1) Height of site is the altitude of the gun above the assumed datum level. One of the conditions assumed as standard is that the gun and the target are at the same altitude. If this situation does not exist, a correction in the range must be considered.

Example: Assume that a target at a map range of 10,000 yards is below the guns a distance of 500 feet and that all other conditions are normal. If the gun is set to fire at a level point range of 10,000 yards, the projectile should attain this range while still 500 feet above the target. In descending this distance of 500 feet, it will continue to move forward and will therefore fall beyond the target.

(2) The height of tide at the time of firing must be taken into consideration in determining the actual height of gun above or below the target. The actual difference in elevation will be the elevation of the gun above datum level minus (algebraically) the height of tide above or below the same datum. In fixed batteries, the range-elevation scale or range drum is corrected for height of site above mean low water. In this case the effect of height of tide above mean low water can be determined from the *target above gun* table, even though the target may actually be below the gun. The procedure for determining the height of site correction depends upon the type of firing table being used.

(3) In tables such as FT 16-E-1 and FT 6-C-2, a table is included for the effects of target above

or below gun. Entering the proper table with the height of site to the nearest foot and the uncorrected range, the effect of height of site may be found. The sign of the effect is changed and applied as a range correction. The calculations mentioned in this paragraph are illustrated in the sample problems at the end of this chapter.

(4) Dealing with firing tables of the type used with 155-mm gun necessitates entirely different treatment than that of most tables. In these tables, the angle of site is determined trigonometrically. A correction known as the complementary angle of site, determined by means of column 13 or 14 in table A of the firing tables, is applied to the angle of site to give the corrected angle of site. The corrected angle of site is applied in the proper sense (plus or minus) to the quadrant elevation corresponding to the corrected range.

b. Weight of projectile. (1) Variations in the weight of the projectile have two effects which are contradictory. An increase in the weight will tend to cause a decrease in the range due to a decrease in muzzle velocity. At the same time it will tend to cause an increase in the range due to increase in the ballistic coefficient (see par. 13). The net effect is to decrease the range at shorter ranges and to increase the range at longer ranges. The value of the net effect and the point where the effect changes sign depend on the gun, projectile, and angle of elevation. In some cases, the range at which the effect would change sign is beyond the maximum range of the materiel. A decrease in the weight of the projectile has opposite effects.

(2) Firing tables contain the effects due to variations in the weight of the projectile. The effect in yards of range may be found by entering the tables with the range and weight (or the variation in weight) as arguments. In preparation for firing, the general procedure is to determine the mean weight of the projectile to be fired and apply a

range correction for the departure of the mean weight from the standard listed in the firing tables for that ammunition.

c. Muzzle velocity. (1) *General.* The muzzle velocity is one of the factors that influences the shape of the trajectory and therefore the range. A definite value of this velocity is assumed prior to computation of the trajectory and the firing tables. This value, called *standard muzzle velocity*, is listed in all firing tables. Each powder lot is proof-fired by the Ordnance Department upon receipt from the manufacturer, its actual velocity measured by chronograph, and the powder issued to the service if the measured velocity lies within certain allowable limits of the standard. A powder tag listing the lot number and the assumed velocity at standard temperature (70° F.) is tied to each charge.

(2) *Temperature of powder.* The temperature of powder affects the rate of burning of the charge. For a given powder charge, the higher the temperature, the higher is the expected velocity. Since the firing tables are constructed on the assumption that the powder temperature is a particular value, that is, 70° F., it is necessary to determine the temperature at the time of firing and correct for the variation from standard. In the concrete magazines of fixed emplacements, the temperature does not vary greatly from hour to hour and can be taken as the temperature of the powder that has been stored therein for at least 2 weeks. In the field, the temperature of the powder can be obtained from a thermometer which has been inserted in a powder container for 5 minutes. The temperature of one charge may be accepted as that of a group of charges stored together under like conditions. Muzzle velocity, always listed at standard temperature, must be corrected for the prevailing temperature of the powder. On the basis of its departure from the standard velocity

listed in the firing tables, a correction in range is determined. The effect of variations of temperature on the muzzle velocity may be obtained from a chart or table in the firing tables. The chart or table is entered with temperature to the nearest degree, and the percentage change taken to the nearest 0.1 percent or nearest f/s.

(3) *Erosion of the guns.* As the actual muzzle velocity developed by a battery will depend on the condition of the guns, it is important for a battery to know the muzzle velocity to be expected from its guns with the powder to be fired. The most reliable source of information in this connection is a record of previous firings with the same guns and ammunition. When a new lot of powder which has never been fired in the guns of the battery is to be used, the only available figures on muzzle velocity will be the powder tag velocity. If firings of the same guns with other powder lots having powder tag velocities approximately equal to the powder tag velocity of the new lot have indicated a consistent departure from powder tag velocities, the same departure can be expected with the new powder lot. A correction for this expected departure can be made before firing. However, the correction should be based on the firings of more than one other powder lot, since the results of firing only one will not indicate whether the difference in muzzle velocity is due to erosion in the guns or to the condition of the powder itself. As soon as the firing of the new lot has been completed, the actual muzzle velocity developed should be determined (see par. 97, for example). This muzzle velocity should then be used until succeeding firings indicate a change is needed.

d. Density. The density of the air measures the mass that must be displaced by the projectile. The greater this mass or density, the more energy will be absorbed in overcoming it, and the less will be the range attained. With other conditions nor-

mal, the projectile will fall short of the target when the density is greater than normal and beyond the target when density is below normal. The meteorological message gives for the maximum ordinate the ballistic density in percent of standard. The ballistic density is a fictitious constant density which would have the same total effect on the projectile during its flight as the varying densities actually encountered. This ballistic density is calculated with reference to the altitude of the meteorological datum plane and must be corrected for the difference in altitude between the datum plane and the battery. This can be done by means of the density formula appearing in part 1 of the firing tables, which states that for an increase of 100 feet in altitude the density decreases 0.3 percent and vice versa. The ballistic density in percent of standard so corrected is then applied to the range correction board, which mechanically determines the proper range percentage correction. To check the accuracy of the correction thus applied, part 2 of the firing tables may be entered with the ballistic density expressed as a percentage increase or decrease from normal to find the resulting effect on the range.

e. Air temperature. (1) The resistance offered to a moving projectile by the air is determined in part by the elasticity of the air. The elasticity of the air (which is a measure of the ability of the air to assume its former shape after being displaced) is in turn affected by the temperature of the air itself. The effect on range due to the temperature of the air is therefore spoken of as the elasticity effect. Because of the elasticity of the air, the projectile sets up a wave motion, the velocity of which depends on the elasticity of the air and is approximately equal to that of sound. The effect of this wave motion on the projectile is dependent on the relation between the velocity of the projectile and the velocity of the wave mo-

tion. As the velocity of the wave motion is influenced by the air temperature, the air resistance is influenced and consequently the range.

(2) With some guns the remaining velocity of the projectile never gets as low as the velocity of the wave motion, while with others it never gets as high as the velocity of the wave motion. With low velocities, the range effect for a decrease of temperature is usually positive, and for an increase of temperature it is usually negative. With higher velocities the converse applies.

(3) With some guns the remaining velocity of the projectile passes through the velocity of the wave motion. In this case the net range effect for a decrease in temperature may be either positive or negative, depending on the length of time that the velocity of the projectile is greater than the velocity of the wave motion and the time it is less. For a particular gun these times will depend on the shape of the trajectory, that is, on the elevation or range. Therefore, for some ranges (a particular gun being considered) the range effect for a decrease of temperature is positive and for other ranges, negative; the converse is true for an increase of temperature. The point where this change of sign occurs depends on the materiel. For some guns the ranges do not extend to the point where a change of sign occurs.

(4) When the temperature is not standard (59° F.), an elasticity correction is necessary. The temperature at the battery may be observed by a thermometer or it may be taken from the meteorological message. In the latter case the temperature must be corrected, if there is a difference in altitude between the meteorological datum plane and the battery, by using the thermometric formula in part 1 of the firing tables. The formula states that for every 100-foot increase in altitude, the temperature decreases $1/5^{\circ}$ F.; and for every 100-foot decrease, the temperature increases

1/5° F. The temperature at the battery is applied on the range correction board. The mechanical correction thus obtained may be checked by entering part 2 of the firing tables with arguments of range and temperature to find the corresponding effect on the range.

f. Wind. The effect of the wind on a projectile can be resolved for convenience into two component effects as follows: one perpendicular to the line of fire (affecting direction), and one parallel to the line of fire (affecting range). If the wind is parallel to the line of fire, the direction component is zero; and if the wind is perpendicular to the line of fire, the range component is zero. It is necessary, therefore, to determine the relationship between the azimuth of the plane of fire and the azimuth of the ballistic wind and then resolve the wind into its range and cross-wind components. By reference to the firing tables, the magnitude of the effect on range and deflection may be determined and the corrections applied. The procedure is as follows:

(1) Determine the proper line of the meteorological message to be used. (For a discussion of the meteorological message, see FM 4-15, or the introductions in the firing tables.)

(2) Subtract the azimuth of the target (in mils measured from north taken to the nearest 100 mils) from the azimuth of the ballistic wind obtained from the meteorological message. This gives the chart direction of the wind.

(3) Using the answer obtained in (2) above to the nearest 100 mils, enter the wind component chart or wind component table in part 1 of the firing tables. The chart provides a graphical means of transforming the polar coordinates of chart direction (vectorial angle) and wind velocity (radius vector) into rectangular coordinates of range component (ordinate) and deflection component (abscissa). The wind component table provides

a tabular means of doing the same thing but gives the components for a wind velocity of 1 mile per hour only. This may be converted to the proper value by multiplying by the wind velocity taken from the meteorological message. The wind effects may then be found by entering the firing tables with the uncorrected range and range wind component for the range effect, and with the corrected range and cross-wind component for the deflection effect. A deflection effect is calculated on the basis of *corrected range*.

g. Rotation of the earth. For all guns of 6-inch caliber and above (except 155-mm G.P.F.), the effects on range of rotation of the earth are considered in calculating firing data. A physical explanation of the effects of the earth's rotation on a projectile is entirely too complex to warrant discussion here. It suffices for the artilleryman to know that the magnitude of the effect is a function of the uncorrected range to the target, the latitude of the battery, and the target azimuth. These are used as arguments with which to enter the tables.

21. CONDITIONS AFFECTING DIRECTION. a.

General. Deflection effects are computed on the basis of *corrected range*. Because of the difference between corrected range and map range, with the accompanying difference in times of flight, the period during which the projectile is exposed to the conditions affecting deflection is altered. Thus it is the corrected range which must be used to obtain the most accurate effects of wind, drift, and rotation of the earth.

b. Wind. Wind will have an effect on the direction of a projectile unless the wind is blowing parallel to the plane of fire. To determine the cross-wind component of the wind, the same procedure is followed as in finding the range wind component. (See par. 20f.) The chart direction of the wind is calculated by subtracting the

azimuth of the target (in mils from north and taken to the nearest 100 mils) from the azimuth of the ballistic wind, and the wind component chart or table is entered with the chart direction to the nearest 100 mils. The cross-wind component is determined for the velocity of the wind, and the proper table in part 2 of the firing tables entered with the corrected range to determine the cross-wind effect in mils or degrees.

c. Drift. The rifling in the bore of a gun imparts a rotary motion to the projectile in flight. The resistance of the atmosphere to this movement of the projectile causes it to deviate from its original plane of direction. This deviation is called drift, and a correction therefor must be made to the azimuth or deflection. The corrected range is used to enter the firing tables and the drift effect is determined in angular units. Since the rifling in seacoast artillery guns is to the right, a left correction for drift must be made to azimuth or deflection. An exception is the 37-mm sub-caliber gun in which the rifling is to the left.

d. Rotation of the earth. Corrections for rotation of the earth are made for all guns of 6-inch caliber and above (except 155-mm G.P.F.). Whether or not the effects of rotation of the earth should be considered can be determined by reference to the firing tables concerned. The deflection effect of rotation of the earth depends upon the latitude of the battery, the corrected range, and the azimuth to the target. These arguments are used to enter the firing tables and the effect in mils determined.

22. PRECISION REQUIRED IN FIRING TABLE COMPUTATIONS. By using the firing tables and tables of logarithms, it is possible to determine the different ranges, azimuths, and effects of non-standard conditions to a great degree of refinement. But it would obviously be absurd to de-

termine the ranges to tenths of yards when the coordinates from which they have been determined may be in error by as much as 1 yard; or to correct for a fraction of a foot per second of muzzle velocity when the original determination may have been in error by 1 to 5 feet per second. There is rarely any justification for exceeding the following limits of accuracy in the deliberate computation of firing data:

a. Range.

Map range for differential effects.....	100 yards
Map range for angle of site (155-mm).....	10 yards
Range effects.....	1 yard
Firing range for firing elevation.....	10 yards
Firing elevation.....	0.01°, 1 mil, or 1 minute
Corrected range for lateral effects....	100 yards

b. Azimuth.

Target azimuth (for chart direction of wind).....	100 mils
Target azimuth (for effect of rotation).....	1°
Lateral effects.....	0.01° or 0.1 mil
Firing azimuth or deflection.....	0.01° or 1 mil

c. Miscellaneous.

Density.....	1 percent
Height of site, 16-inch tables.....	1 foot
Height of site, 155-mm tables:	
Map range for computing.....	10 yards
Height of site.....	1 yard
Angle of site.....	0.1 mil
Latitude of gun.....	1°
Muzzle velocity.....	1 foot/second
Temperature (air or powder).....	1° F.
Weight of projectile.....	1 percent
Wind:	
Chart direction.....	100 mils
Components.....	1 mph

Section IV. EXAMPLES

23. GENERAL. a. In order to familiarize the seacoast artillery officer with the use of firing tables, the following problems pertaining to types

of armament likely to be encountered are presented. Examples are given for the 6-inch and 16-inch guns as representative of medium range and long range guns, and for the 155-mm gun because of the special type of firing table furnished for that gun. These problems are presented to show the calculations usually necessary to obtain the corrected firing data needed to check the graphical solution obtained by plotting room equipment.

b. To arrive at the firing data, it is necessary, when using firing tables, to calculate the range and azimuth effects, to convert these effects into corrections by changing their signs, and to apply these corrections to the uncorrected range and azimuth.

24. 6-INCH GUN BATTERY. A 6-inch gun battery M1900 on barbette carriage M1900 is to fire, using 108-pound AP projectile, fuze B.D., Mk. V (FT 6-C-2). With the following data assumed, compute the corrected quadrant elevation and corrected azimuth. (All page numbers refer to FT 6-C-2, 1940.)

Map range to target.....	9,400 yards
Azimuth of target.....	270° (S.) or 90° (N.)
Muzzle velocity (previous firings)....	2,540 f/s
Powder temperature.....	84° F.
Weight of projectile.....	106 pounds
Latitude of battery.....	34° N.
Height of site.....	200 feet
Height of tide.....	0 feet

The following meteorological message was furnished the battery:

MOBMOB
 30488
 0071099 (line 0)
 1071199 (line 1)
 2081298 (line 2)
 3091297 (line 3)
 4091397 (line 4)

From part 2, table A, page 20, column 8, the maximum ordinate of the trajectory at 9,400 yards is 1,041 feet. The proper line of the meteorological message to be used is thus line 2. (See p. XII.)

a. Range effects. (1) *Height of site* (see pt. 2, table B, pp. 27, 28).

Height of target (feet)	Target below gun Map range (yards)		
	9,000	9,400	9,500
-200	+396	+362	+353

Effect = +362 yards

(2) *Weight of projectile* (see pt. 2, table D, p. 34).

108 - 106 = 2 pounds
Decrease in weight = 2 percent

Range	Variation in weight of projectile (percent)
	-2
9,000	+17
9,400	+14
10,000	+9

Effect = +14 yards

(3) *Muzzle velocity* (see pt. 2, table F b, p. 42).

Developed muzzle velocity (previous firings) at 70° F.....	2,540 f/s
Present powder temperature.....	84° F.
Effect in f/s of 84° F. (see chart, p. 9).....	+19 f/s
Expected muzzle velocity (2,540 f/s + 19 f/s).....	2,559 f/s
Decrease in muzzle velocity from standard (2,600 f/s - 2,559 f/s).....	41 f/s

Range	Decrease in muzzle velocity (f/s)		
	40	41	50
9,000	-193	-242
9,400	-198	-203	-248
10,000	-206	-258

Effect = -203 yards

(4) *Density* (see pt. 2, table G a, p. 44). If any difference in altitude exists between the m.d.p. and the battery served by the message, consideration must be given to correcting the density listed in the message in accordance with the following formula:

0.3 percent = *decrease* in air density for 100-foot *increase* in altitude.

0.3 percent = *increase* in air density for 100-foot *decrease* in altitude.

Ballistic density at m.d.p. (see line 2, meteorological message)..... 98 percent
 Altitude of m.d.p. (see five-digit group, meteorological message)..... 400 feet
 Altitude of battery..... 200 feet
 Difference in altitude..... 200 feet

Since the battery is 200 feet *below* the m.d.p., the density is increased by 0.6 percent or 1 percent. The density at the battery is thus 98 percent + 1 percent = 99 percent, or a decrease of 1 percent from a standard of 100 percent.

Range	Decrease in air density (percent)
	1
9,000	+34
9,400	+37
10,000	+41

Effect = +37 yards

(5). *Temperature* (see pt. 2, table H, p. 48). The meteorological message lists the m.d.p. temperature as 88° F. However, the 200-foot difference in altitude between the m.d.p. and battery necessitates a possible correction:

$1/5^\circ$ F. = *decrease* in temperature for 100-foot *increase* in altitude.

$1/5^\circ$ F. = *increase* in temperature for 100-foot *decrease* in altitude.

$2 \times 1/5^\circ$ F. = $2/5^\circ$ F., which, being less than $1/2^\circ$ F., may be disregarded.

The battery temperature is thus 88° F.

Range	Air temperature (degrees F.)		
	80	88	90
9,000	-25	-36
9,400	-26	-36	-38
10,000	-28	-41

Effect = -36 yards

(6) *Wind.*

Wind azimuth (line 2)..... 800 mils
Target azimuth..... 90° (N.) or 1600 mils (N.)

To determine the chart direction of the wind, the azimuth of the plane of fire (target azimuth) must be subtracted from the wind azimuth, 6400 mils being added to the latter if necessary.

Wind azimuth.....	800 mils
	<u>+6400 mils</u>
Wind azimuth.....	7200 mils
Target azimuth.....	<u>-1600 mils</u>
Chart direction of wind.....	5600 mils

Pages 2 and 3 (FT 6-C-2) contain the wind component chart. Since wind velocity from line 2 equals 12 mph, the lateral and range components for a 6-mph wind should be determined and multiplied by 2. Entering the wind velocity chart with 5600 mils, a 6-mph wind has a lateral or deflection component of 4.3 mph and a range component of 4.3 mph. The range wind component is thus $2 \times 4.3 \text{ mph} = 8.6$ or 9 mph. The chart indicates that in this quadrant the wind diminishes the range and carries the projectile to the right. The range and deflection components should thus be expressed:

Range.....	-9 mph
Deflection.....	R 9 mph

Part 2, table I, page 50, lists the effects on range of a rear wind. Effects of a head wind are obtained by changing the sign of the effect in accordance with the footnote.

Range	Head Wind (miles per hour)		
	5	9	10
9,000	-18	-36
9,400	-20	-36	-40
10,000	-23	-45

Effect = -36 yards

(7) *Rotation of the earth* (see pt. 2, table E, pp. 37 and 38).

Map range to target..... 9,400 yards
 Azimuth of target..... 90° (N.)
 Latitude of battery..... 34° N.

Range	Azimuth	Latitude		
		30°	34°	40°
8,000	90°	+44	+39
9,400	90°	+46	+44	+40
10,000	90°	+47	+41

Effect = +44 yards

(8) *Summation.*

	Effects (yards)	
	Plus	Minus
Height of site.....	362	
Weight of projectile.....	14	
Muzzle velocity.....		203
Density.....	37	
Temperature.....		36
Wind.....		36
Rotation of earth.....	44	
Totals.....	457	275
Combined effect.....	182	
Combined correction.....		182
Map range.....		9,400
Corrected range (9,218 yards).....		9,220
Q.E. for corrected range (see below).....		115 mils

NOTE. *Q.E. for corrected range* (see pt. 2, p. 59). To find the quadrant elevation, it is necessary to enter the range-elevation relationship in the firing tables. Interpolation is usually necessary.

Range	Q.E. (mils)
9,200	115.0
9,220	115.4
9,300	117.0

b. Direction effects. (1) *Wind* (see pt. 2, table J, p. 51).

Corrected range (nearest 100 yards)..... 9,200 yards
 Lateral wind component (previously determined)..... R 9 mph

Range	Cross-wind effect (degrees) (mph)		
	0	9	10
9,000	0	R 0.14
9,200	0	R 0.14	R 0.15
10,000	0	R 0.17

Effect = R 0.14°

(2) *Drift* (see pt. 2, table A, p. 21).

Range	Deflection due to drift
9,000	R 0.30°
9,200	R 0.32°
9,500	R 0.35°

Effect = R 0.32°

(3) *Rotation of the earth* (see pt. 2, table K, pp. 53 and 54).

Range	Azimuth	Deflection effect in mils Latitude		
		30° N.	34° N.	40° N.
8,000	90°	R 0.4	R 0.5
9,200	90°	R 0.5	R 0.5	R 0.6
10,000	90°	R 0.6	R 0.7

Effect = R 0.5 mil = R 0.03°

(4) *Summation.*

	Effects	
	Right	Left
Wind.....	0.14°	
Drift.....	0.32°	
Rotation of earth.....	0.03°	
Combined effect = R 0.49°.....	R 0.49°	
Combined correction = L 0.49°.....		L 0.49°
Uncorrected azimuth = 270.00°.....		270.00°
Corrected azimuth.....		269.51°

25. 155-MM GUN BATTERY. A 155-mm gun battery is equipped with guns M1917A1, firing shell HE M101 with fuze P.D. M51, normal charge. (FT 155-U-1.) Assuming the following data, determine the corrected quadrant elevation and deflection.

Map range.....	9,500 yards
Azimuth of target..... 225° (S.) =	45° (N.)
Height of site.....	300 feet
Height of tide.....	+15 feet
Muzzle velocity (previous firings).....	1,939 f/s
Powder temperature.....	64° F.
Weight of projectile.....	5 sq.

The following meteorological message was furnished the battery:

MFTMFT
30580
0201704
1181504
2161404
3161203
4141402
5121402

From page 20, column 10, the proper line of the meteorological message is line 3. (For general reference, see pt. 2a-1, table A, pp. 20 and 21.)

a. Range effects. (1) *Height of site.* Since the firing tables for 155-mm guns do not contain tables for *target above gun* or *target below gun*, the procedure for obtaining the height of site corrections is different from that used in the preceding problem. The method used consists of determining the quadrant angle of site trigonometrically and adding the complementary angle of site. The angle of site is obtained by multiplying the value obtained in table A, column 13 or 14, of the firing tables by the quadrant angle of site. This results in an angular correction which is added algebraically to the quadrant elevation corresponding to the range corrected for all nonstandard conditions except height of site. The difference in elevation between the target and the gun is equal to the altitude of the battery minus the height of tide.

Altitude of battery.....	300 feet
Height of tide.....	15 feet
	285 feet or 95 yards

The tangent of the angle of site is therefore 95/9500 or 0.0100. The angle of site is found by the following interpolation (table LV, TM 5-236).

<i>Mils</i>	<i>Tangent</i>
10	0.00980
10.2	0.01000
11	0.01080

Angle of site = -10.2 mils

Complementary angle of site for 1-mil	
angle of site at 9,500 yards.....	-0.06 mil
For -10.2 mils (10.2 × -0.06).....	-0.6 mil (0.612 mil)
Angle of site.....	-10.2 mils
Complementary angle of site....	- 0.6 mil
Corrected angle of site.....	-10.8 mils

See (7) for manner of applying this correction.

(2) *Weight of projectile.*

Effect of increase of 1 sq..... +5 yards
Effect of weight of projectile..... +5 yards
Effect = +5 yards

(3) *Muzzle velocity.*

Developed muzzle velocity (previous firings) at 70°..... 1,939 f/s
Present powder temperature..... 64° F.
(See pt. 2a-1, table B, p. 26.)

Powder temperature	Change in velocity (f/s)
60	-13
64	-8
70	0

Expected muzzle velocity at 64° F.
(1,939 f/s - 8 f/s)..... 1,931 f/s
Change in muzzle velocity (decrease)
(1,955 f/s - 1931 f/s)..... 24 f/s
Effect of +1 f/s at 9,500 yards (p. 21, col. 17)..... +6.2 yards
Effect of +24 f/s at 9,500 yards (6.2 × 24)..... +148.8 yards
Effect of 24 f/s. *decrease* in muzzle velocity..... -149 yards
Effect = -149 yards

(4) *Density.*

Altitude of m.d.p..... 500 feet
Altitude of battery..... 300 feet
Altitude difference..... 200 feet

Density from meteorological message.....	103 percent
Correction for altitude difference.....	+1 percent (+0.6 percent)
Corrected density.....	104 percent
Effect of 1 percent increase at 9,500 yards.....	-35 yards
Effect of 4 percent increase 100 percent (standard) + 4 percent ...	-140 yards
	Effect = -140 yards

(5) *Temperature.*

Temperature at m.d.p.....	80° F.
Correction for altitude difference	+0.4° F. disregarded as it is less than +0.5° F.
Effect of 1° F. increase.....	+0.4 yard
Effect of 21° F. increase.....	+8.4 yards
	Effect = +8 yards

(6) *Wind.*

Wind azimuth.....	1600 mils
Target azimuth (N.).....	<u>-800 mils</u>
Chart direction of wind.....	800 mils

Range wind for a 1-mph wind with an 800-mil chart direction of wind = -0.71 mph (see p. 9). For a 12-mph wind, $12 \times -0.71 \text{ mph} = -8.52 \text{ mph}$ or -9 mph (to the nearest mile).

Range effect of a rear wind of 1 mph = +6.0 yards; range effect for a head wind of 1 mph = -6.0 yards. Range effect for a head wind of 9 mph = -54 yards. Effect = -54 yards

(7) *Summation.* The following table includes a summation of:

(a) All range effects except the effect for height of site.

(b) Angular correction for height of site.

	Effects (yards)	
	Plus	Minus
Weight of projectile.....	5	
Muzzle velocity.....		149
Density.....		140
Temperature.....	8	
Wind.....		54
Totals.....	13	343
Combined effect.....		330
Combined correction.....	330	
Map range.....	9,500	
Corrected range (less height of site).....	9,830	
Corresponding quadrant elevation ¹	239.7 mils	
Height of site correction.....		10.8 mils
Quadrant elevation (to nearest mil).....	229 mils (228.9 mils)	

<i>Range</i>	<i>Q.E. (mils)</i>
9,800.....	238.4
9,830.....	239.7
9,900.....	242.6

¹ The quadrant elevation corresponding to 9,830 yards is found by interpolation (see col. 2, p. 20 of F.T. 155-U-1).

b. Direction effects. (1) Wind.

Cross-wind component for 1 mph (chart direction of wind is 800 mils)..... L 0.71 mph
 For 12 mph..... L 9.0 mph (L 8.52)
 Deflection effect of 1 mph at 9,500 yards..... L 0.4 mil
 Deflection effect of 9 mph..... L 3.6 mils or L 0.20°
 Effect = L 0.20°

(2) Drift (see p. 20, col. 11).

Drift effect for 9,500 yards..... R 5 mils or R 0.28°
 Effect = R 0.28°

(3) Summation.

	Effects	
	Right	Left
Wind.....		0.20°
Drift.....	0.28°	
Combined effect.....	0.08°	
Combined correction.....		0.08°
Uncorrected azimuth.....		45.00°
Corrected azimuth.....		44.92°

26. 16-INCH GUN BATTERY. A 16-inch gun battery, Mk. II (Navy), is to fire, using projectile, AP, 2,240-lb., Mk. XI, full charge (FT 16-E-1). With the following data assumed, compute the quadrant elevation and the corrected azimuth. (Page references in the problem refer to pages in the firing table.)

Map range..... 22,000 yards
 Azimuth of target..... 240° (S.)
 Muzzle velocity (powder tag)..... 2,645 f/s
 Powder temperature..... 74° F.
 Height of site..... 200 feet
 Height of tide..... +20 feet
 Latitude of battery..... 44° N.

The following meteorological message was furnished the battery:

MFMMFM
 30394
 0211499
 1211498
 2221598
 3221697
 4231697
 5241696
 6241696
 7251894

From page 84, column 8, the maximum ordinate at 22,000 yards is 4,154 feet. The maximum ordinate is then 4,154 — 100 or 4,054 feet above m.d.p. The proper line of the meteorological message to be used is therefore zone 4 (see p. XV).

a. Range effects. (1) *Height of site* (see pt. 2b, table B, p. 102).

Altitude of battery.....	200 feet
Height of tide (subtract).....	20 feet
Gun above target.....	180 feet

Height of target (feet)	Target below gun Map range 22,000
-180	+203 yards

Effect = +203 yards

(2) *Weight of projectile* (see table D, p. 115). Because of the small weight tolerance of ± 6.5 pounds for the 2,240-pound AP projectile Mk. XI, the projectile weight effect on range is negligible at all ranges.

(3) *Muzzle velocity* (see pt. 2b, table F a, p. 124).

Muzzle velocity (powder tag) at 70° F.....	2,645 f/s
Present powder temperature.....	74°
Effect in f/s of 74° F. (See chart, p. 9.)....	+7 f/s
Expected muzzle velocity (2,645 f/s + 7 f/s)	2,652 f/s
Increase in muzzle velocity over standard (2,652 f/s — 2,650 f/s).....	2 f/s

Range	Increase in muzzle velocity (f/s)		
	0	2	10
22,000	0	+28	+142

Effect = +28 yards

(4) *Density* (see pt. 2b, table G a, p. 132).

Altitude of m.d.p.....	300 feet
Altitude of battery.....	200 feet
Altitude difference.....	100 feet
Correction for altitude difference	+0.3 percent disregarded as it is less than 0.5 percent.
Density	97 percent
Effect of 3 percent (100 percent - 97 percent) decrease from standard at 22,000 yards.....	+174 yards

Effect = +174 yards

(5) *Temperature* (see pt. 2b, table H, p. 140).
The correction in temperature because of altitude difference between the meteorological datum plane and battery is less than 0.5° F. and may be disregarded.

Range	Air temperature		
	90°	94°	100°
22,000	-140	-157	-182

Effect = -157 yards

(6) *Wind*.

Ballistic wind azimuth.....	2300 mils
Ballistic wind velocity.....	16 mph
Target azimuth in degrees.....	240° (S.) or 60° (N.)
Target azimuth in mils (angular conversion table, p. 6).....	1100 mils (1067 mils)
Ballistic wind azimuth.....	2300 mils
Target azimuth.....	-1100 mils
Chart direction of wind.....	1200 mils

Entering the wind component chart on pages 2 and 3, find the range wind component for a 16-mph wind. The range wind component for a -8-mph wind is -3 mph; for a 16-mph wind it is 2×-3 mph = -6 mph. The effects in yards of range due to head wind are listed in part 2b, table I b, page 144.

Range	Head wind (mph)		
	5	6	10
22,000	-20	-24	-40

Effect = -24 yards

(7) *Rotation of the earth* (see pt. 2b, table E, pp. 120, 121).

Map range to target..... 22,000 yards
 Azimuth of target..... 60° (N.)
 Latitude of battery..... 44° N.

Range	Azimuth	Latitude		
		40°	44°	50°
22,000	60°	+109	+102	+92

Effect = +102 yards

(8) *Summation.*

	Effects (yards)	
	Plus	Minus
Height of site.....	203	
Muzzle velocity.....	28	
Density.....	174	
Temperature.....		157
Wind.....		24
Rotation of earth.....	102	
Totals.....	507	181
Combined effect.....	326	
Combined correction.....		326
Map range.....		22,000
Corrected range (21,674 yards).....		21,670
Q.E. for corrected range (see below).....		214 mils

NOTE. *Q.E. for corrected range* (see pt. 2b, table A, p. 84).

Range	Q.E. (mils)
21,600	212.6
21,670	213.6 (214.0)
21,700	214.0

b. Direction effects. (1) *Wind* (see pt. 2b, table J, p. 146).

Chart direction of wind..... 1200 mils
 Deflection wind component for 16-mph
 wind (see chart, pp. 2 and 3) L 15 mph

Range	Cross-wind (mph)		
	10	15	20
21,000	L 0.08°	L 0.16°
21,700	L 0.08°	L 0.13°	L 0.17°
22,000	L 0.08°	L 0.17°

Effect = L 0.13°

(2) *Drift* (see pt. 2b, table A, p. 85).

Range	Deflection due to drift
21,500	R 0.45°
21,700	R 0.47°
22,000	R 0.50°

Effect = R 0.47°

(3) *Rotation of the earth* (see pt. 2b, table K, pp. 152 and 153).

Corrected range to target..... 21,670 yards
 Azimuth of target..... 60° (N.)
 Latitude of battery..... 44° N.

Range	Azimuth	Deflection effects in mils Latitude		
		40° N.	44° N.	50° N.
20,000	60°	R 1.2	R 1.3	R 1.5
21,700	60°	R 1.4
22,000	60°	R 1.3	R 1.4	R 1.6

Effect = R 1.4 mils or R 0.08°

(4) *Summation.*

	Effects	
	Right	Left
Wind.....		0.13°
Drift.....	0.47°	
Rotation of earth.....	0.08°	
Totals.....	0.55°	0.13°
Combined effect.....	0.42°	
Combined correction.....		0.42°
Uncorrected azimuth.....		240.00°(S.)
Corrected azimuth.....		239.58°(S.)

CHAPTER 3

PROBLEMS RELATING TO POSITION

Section I. GENERAL

27. DEFINITIONS. **a. Mask.** Any natural or artificial feature of or on the terrain which affords shelter from view.

b. Defilade. The vertical distance by which a position is concealed from enemy observation. If the smoke and flash of firing are also concealed, the battery is said to have smoke and flash defilade.

c. Dead areas. Areas that cannot be reached by fire. These may be caused by masks in front of the battery as well as by obstructions in the descending path of the projectile and by limits of traverse and elevation of the gun.

d. Probable error. Error which is as likely as not to be exceeded. Value which will in long run be exceeded half the time and not exceeded half the time.

e. Fork. Difference in range or elevation or in direction required to change center of impact by four probable errors.

28. LIMITATIONS OF FIRE DUE TO POSITION.

a. Factors controlling minimum range. The minimum map range at which a gun can fire depends on—

(1) The minimum quadrant elevation at which the gun can be fired as fixed by the design of the carriage.

(2) The difference in elevation between the gun and the target.

(3) The interference caused by intervening terrain features.

b. Height of site and limitation of carriage. For most fixed or mobile guns, there is a definite quadrant elevation below which it is either unsafe or impossible to fire the gun. If such a gun is placed at a considerable elevation above sea level, there will be a minimum range corresponding to this minimum quadrant elevation.

c. Masks. Local topography, both in the vicinity of the firing position and in the vicinity of the target, materially affects the possibilities of fire. Where there is a hill or other form of mask between the gun and the desired field of fire, the minimum range in the sector of the field of fire beyond the mask may be controlled by the quadrant elevation necessary to clear the mask. This elevation is also considered as a minimum elevation but must not be confused with minimum elevation due to the construction of the carriage.

Section II. MINIMUM ELEVATION

29. GENERAL. Figure 3 shows a gun G emplaced behind a mask H at a distance d from the gun. If the gun is given an elevation to hit the crest of the mask, dispersion will cause half of the shots to clear the mask and the other half not to clear it. For standard ballistic conditions, this elevation results in a minimum of dead area behind the mask. If it is desired that all except wild shots clear the mask, one fork at the range d to the mask must be added to the elevation required to hit the crest. If friendly troops or installations occupy the crest, an additional fork is added as a

safety factor. The lowest quadrant elevation that will give the desired clearance of the mask is called the minimum elevation.

30. DETERMINATION. a. For all seacoast artillery guns except the 155-mm gun, there are two methods of calculating the elevation required to hit the crest of the mask, the choice depending on the distance from the gun to the mask. In calculating minimum elevation, the powder charge developing the lowest muzzle velocity should be used in order to reduce the dead area to a minimum.

(1) *Distant mask.* If the mask is at such a range from the battery that the effect for target above gun may be found in the firing tables, the point *H* is treated as a target and the map range is corrected for height of site. (See par. 20a.) The firing tables are then entered to determine the corresponding quadrant elevation. This elevation, with or without the addition of one or two forks at range *d*, is the minimum elevation.

(a) *Example.* A battery of 6-inch guns M1900 on barbette carriage M1900 is emplaced at an elevation of 90 feet above mean low water. In a certain sector of the field of fire is an island, the crest of which has an elevation of 530 feet and a map range of 8,000 yards. Friendly installations occupy the crest. Using the 108-pound AP projectile with B.D. fuze Mk. V (FT 6-C-2), *what is the minimum elevation at which the guns can be fired with assurance of clearing the island?*

(b) *Solution.* (All page numbers refer to FT 6-C-2.)

Map range to crest.....	8,000 yards
Target above gun (530 feet - 90 feet = 440 feet.)	
Correction for target above gun (p. 31)..	<u>1,007 yards</u>
Corrected range.....	9,007 yards
Corrected elevation (enter table at 9,010 yards) (p. 59).....	111.2 mils

1 range P.E. at 8,000 yards (p. 19).....	48 yards
2 forks (8 P.E.) = 8×48 yards.....	384 yards
Change in elevation for a 100-yard change in range (p. 18).....	1.8 mils
2-fork elevation = $\frac{384}{100} \times 1.8$ mils.....	6.9 mils
Minimum elevation to clear mask =	
111.2 + 6.9 =	118.1 mils
(For the sake of safety, round off the minimum elevation to the next higher value.)	

Answer: 119 mils

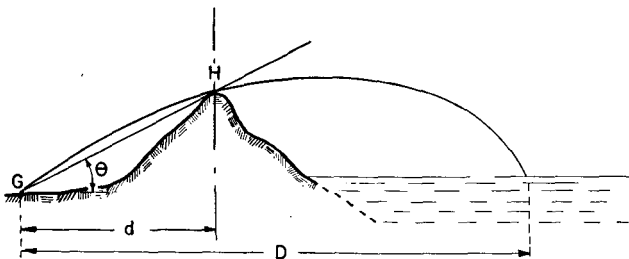

Figure 3. Determination of minimum elevation.

(2) *Near mask.* If the mask is too close to obtain the correction for target above gun from the firing tables, the angle of site (ϵ) is determined. (See fig. 3.) This angle is added to the quadrant elevation for range d to obtain the elevation required to hit the crest. One or two forks may be added if the situation requires. (See par. 8 for definitions of angle of site and quadrant elevation.)

(a) *Example.* In another sector of the field of fire of the battery mentioned in a (1) (a) above, there is, in front of the battery, a sand dune whose crest is 120 feet (40 yards) above the battery and 500 yards away from it. It is desired to hold the dead area to a minimum and still not have an excessive waste of ammunition. *What is the minimum elevation to fire over this mask if there are no friendly troops on the dune?*

(b) *Solution.* If the minimum elevation is taken to hit the top of the dune, 50 percent of the shots can be expected to hit the dune and 50 percent will clear the dune. This will result in a minimum dead area but will cause excessive waste of ammunition. If this elevation is increased by one probable error, 75 percent of the shots will clear the mask. The minimum dead area will accordingly be increased by one range probable error. However, the difference between the two minimum dead areas will be more than compensated for, because by dispersion one-third of the shots clearing the mask can be expected to fall in the space between the two minimum dead areas, and also the waste of ammunition is reduced by one-half.

Tangent of angle of site =	
$\frac{\text{height of crest above battery}}{\text{range from battery to crest}} = \frac{40}{500}$.08000
Angle of site (ϵ).....	81.3 mils
Q.E. to fire 500 yards (p. 58).....	4.4 mils
Minimum elevation to hit top of mask...	85.7 mils
P.E. at this elevation.....	0.8 mil
Minimum elevation for 75 percent of shots to clear mask.....	86.5 mils

Answer: 87 mils

The probable error in mils is obtained as follows: at an elevation of 85.7 mils, the probable error is given as 45 yards (p. 19, col. 16). The change in elevation for a 100-yard change in range at this same elevation is given as 1.7 mils (p. 18, col. 4). The proportionate change in elevation for 45 yards is $\frac{45}{100} \times 1.7 = 0.8$ mil.

b. Since the firing tables for 155-mm guns do not contain effects of height of site, problems of minimum elevation to clear both near and distant masks must be solved by the method in paragraph 25. The complementary angle of site should be included in the calculations. (See par. 20a (4).)

(1) *Example.* A battery of 155-mm guns M1918M1 is emplaced on an island at a height of site of 30 feet. Friendly troops occupy a neighboring island over which this battery must shoot. The crest of the masking island is 240 feet high and 3,500 yards from the guns. *What is the minimum elevation to clear the mask when firing HE shell M101, fuze M51, normal charge? (FT 155-U-1.)*

(2) *Solution.* (Page numbers refer to FT 155-U-1.)

Minimum elevation = angle of site	
+ complementary angle of site	
+ Q.E. to fire 3,500 yards	
+ 2 forks at 3,500 yards	
Tangent of angle of site = $\frac{70}{3500}$02000
Angle of site (ϵ).....	20.4 mils
Complementary angle of site for each mil of angle of site (p. 17).....	0.01 mil
Complementary angle of site ($20.4 \times .01$)	0.2 mil
Q.E. to fire 3,500 yards (p. 16).....	54.4 mils
1 P.E. at 3,500 yards (p. 16).....	14.0 yards
2 forks (8 P.E.) = 8×14 yards.....	112.0 yards
Change in elevation for a 100-yard change in range at 3,500 yards (p. 16).....	1.8 mils
2-fork elevation = $\frac{112}{100} \times 1.8$	2.0 mils
Minimum elevation	
(20.4 + 0.2 + 54.4 + 2.0)	

Answer: 77.0 mils

c. If the height of the mask is not known, the method in paragraph 30b may be used for all guns. The angle of site is determined by boresighting the gun on the crest and then reading the angle of site from the elevation scale or a gunner's quadrant. The range to the mask may be determined on the plotting board or by surveying (if maps of sufficient accuracy are not available).

Section III. MINIMUM RANGE

31. GENERAL. Frequently it is of importance to know the minimum range at which a gun can fire. From figure 3 it is obvious that the minimum range is mostly dependent on the minimum elevation at which the gun can be set. However, minimum elevation fixes only the range to the level point. That range must be corrected for height of site to give the minimum range. Even when there is no mask in front of a battery to limit its elevation, the battery will usually have a minimum range inside of which it cannot fire. This is due entirely to height of site and the fact that the gun is limited to a minimum elevation by the construction of the carriage.

32. DETERMINATION. a. Range-elevation tape.

(1) *Fixed batteries.* Most fixed batteries are equipped with percentage corrector range-elevation tapes corrected for height of site. When the minimum elevation to clear a mask is known, the minimum range is simply that range which appears on the range-elevation tape opposite the known minimum elevation. If a fixed battery is not supplied with a range-elevation tape, the range-elevation relation (corrected for height of site) can be obtained from the emplacement book.

(2) *Mobile batteries.* (a) The procedure is somewhat different for mobile batteries, inasmuch as the Coast Artillery Board supplies them with percentage corrector tapes corrected for height of site to the nearest 100 feet. Additional corrections must be made on the range correction board.

(b) *Example.*

1. A battery of 155-mm guns M1917 is situated 145 feet above sea level. It is located behind a hill which requires a minimum elevation of 54 mils for

all shots to clear the mask. The range-elevation tape on the percentage corrector has been computed for a height of site of 100 feet. *What is the minimum range of the battery when it fires normal charge using shell M101 with P.D. fuze M51? (FT 155-U-1.)*

2. *Solution.*

- (a) Position the proper chart on the range correction board at the range appearing opposite 54 mils of elevation on the percentage corrector tape. This is found to be 3,940 yards.
- (b) After zeroing the range correction board, apply a height of site correction for *target below gun* of 45 feet ($145 - 100$), and read the correction in reference numbers (249).
- (c) Move the ballistic pointer on the percentage corrector to 249 on the ballistic scale.
- (d) Turn the range-elevation tape on the percentage corrector until a range of 3,940 yards, corresponding to 54 mils, appears under the ballistic pointer.
- (e) Read the minimum range, 4,150 yards, under the index line.

3. *Discussion.* In this case the correction was made for *target below gun*, since the tape on the percentage corrector is constructed to take care of a difference of only 100 feet and an additional correction of 45 feet is needed. If the battery had been at an elevation of 55 feet, it would be 45 feet below the elevation for which the tape was constructed, and the correction

of 45 feet would be made for *target above gun*. The reason for this will be apparent if it is assumed that the construction of the percentage corrector tape places the *target* at the elevation for which the tape is constructed. This is a reasonable assumption, since the construction of the range-elevation tape includes the height of site correction for the elevation for which the tape is constructed. It will be noticed that in getting the correction from the range correction board, the range used to enter the chart was not the map range. This is a source of error. If greater precision is desired, the problem can be repeated using the minimum range obtained, 4,150 yards, to get a new ballistic correction from the range correction board in order to work out a new minimum range of about 4,130 yards.

b. Graphical solution. Percentage corrector tapes and range-correction board charts are not computed for ranges of less than 2,000 yards. Thus a minimum map range of less than 2,000 yards cannot be determined on the instruments. Moreover, a minimum range which is due to height of site alone cannot be found by the use of tapes and charts. However, a graphical method of solution of the minimum range problem may be used under any circumstances. It is an accurate, simple, and rapid method, provided a large enough scale is used on the graph to enable accurate readings. The method consists of plotting a graph of the range-elevation relation corrected for height of site. Map ranges are plotted against elevation. Opposite any minimum elevation, the minimum range can be read.

(1) *Example.* A battery of 155-mm guns M1918M1 is emplaced 480 feet above mean low water. Due to a mask, the minimum elevation in one sector of the field of fire is 48 mils. If the battery is firing HE shell M101, fuze P.D. M51, and using normal charge, *what is the minimum range which the battery can attain when engaging water targets in this sector?* (FT 155-U-1).

(2) *Solution.* From page 16 of the firing tables, the level point range corresponding to an elevation of 48 mils is found to be about 3,100 yards. For a series of ranges starting at 3,000 yards and differing by 500 yards, *determine the elevation corrected for height of site.* (See par. 20a (4).) In this particular problem, the height of site correction is added to the quadrant elevation corresponding to the uncorrected map range, neglecting other nonstandard conditions. The following tabulation shows the steps in the solution.

Map range (yards)	Quadrant elevation (mils)	Tan. angle of site $\frac{160}{R}$	Angle of site (mils)	Comp. angle of site for each mil of site (mils)	Comp. angle of site (mils)	Corrected elevation (mils)
3,000	45.4	.05333	54.3	.01	0.5	-9.4
3,500	54.4	.04571	46.5	.01	0.5	+7.4
4,000	64.0	.04000	40.7	.02	0.8	+22.5
4,500	74.2	.03555	36.2	.02	0.7	+37.3
5,000	85.2	.03200	32.6	.03	1.0	+51.6

Sufficient points must be chosen so that a corrected elevation on either side of the minimum elevation of 48 mils can be determined. Plot the corrected elevations against ranges to any convenient scale and connect the points with a smooth curve. (See

fig. 4.) On this curve, locate the point corresponding to the minimum elevation of 48 mils (point A). Read the range corresponding to this point. This is found to be 4,875 yards and is the minimum range of the battery when firing in this direction. From this curve it is also possible to determine the range which will be obtained at a minimum permissible firing elevation providing there is no intervening mask. (See (3) below.)

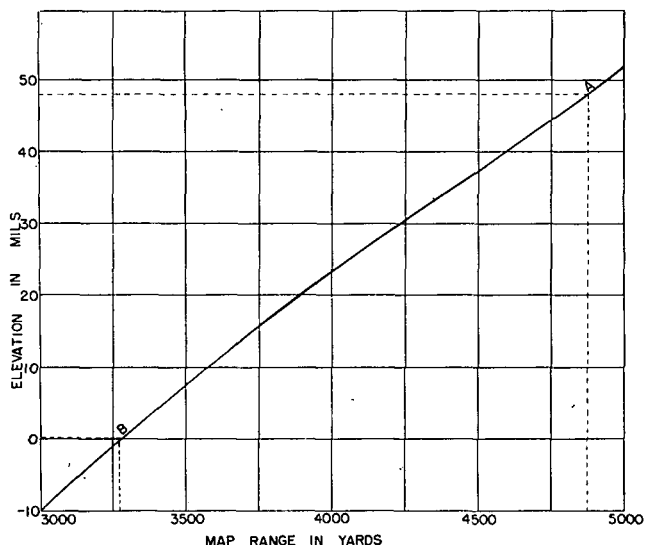

Figure 4. Range-elevation relation example [par. 32b (1) and (2)].

(3) *Example.* In another sector of the field of fire of the battery in the example in b (1) above there is no mask, but the minimum elevation is limited by construction of the carriage to zero mils. What is the minimum range in this sector?

(4) *Solution.* Using the same graph as that used in the solution in (2) above, it is found that opposite zero mils of elevation (point *B*) the minimum map range is 3,280 yards.

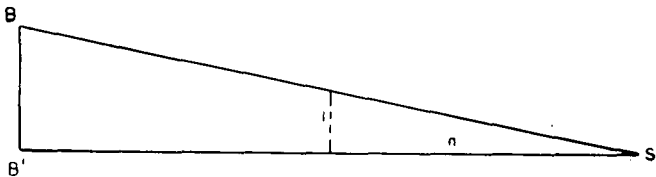

Figure 5. Minimum range by approximate solution.

c. Approximate solution. Using the minimum elevation as determined by one of the methods above, extract from table *A* of the firing tables the corresponding slope of fall which is given in the general form $1/n$. This determines the slope of the line *BS* (which is the line of fall) in figures 5 and 6. Then, by simple proportion, $BB'/B'S = 1/n$ and $B'S = n \times BB'$. The approximate range to the splash *S* may then be computed by the formula: *Expected range* = $GB + B'S = GB + (n \times BB')$. *BB'* must be expressed in yards. Since this method is based on the assumption that the trajectory is a straight line beyond the level point, the approximation will be close only at medium or long ranges, where the angle of fall is large. Note that this approximate method will not solve the problem of minimum range due entirely to height of site.

(1) *Example.* A battery of 6-inch guns M1900 on barbette carriage M1900 is emplaced at a height of site of 90 feet above mean low water. At a range of 10,000 yards, there is a point of land across which the battery may fire at water-borne targets. This land averages 120 feet above mean low water. It is desired that all except wild shots clear the point. There are no friendly troops located there.

What is the minimum range of the battery across this point when it fires the 108-pound AP projectile? (FT 6-C-2.)

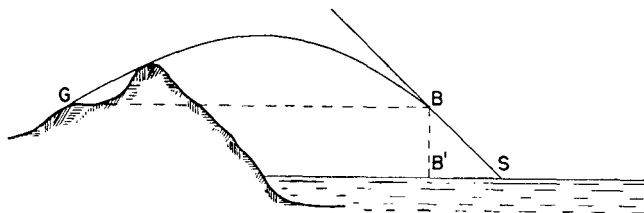

Figure 6. Illustration of example, paragraph 32c (1).

(2) Solution.

Map range to crest.....	10,000 yards
Target above gun (120 feet - 90 feet = 30 feet.)	
Correction for target above gun.....	45 yards
	10,045 yards
Elevation to hit crest (p. 59).....	133.1 mils
1 range P.E. at 10,000 yards (p. 21)....	63 yards
1 fork (4 P.E.) = 4 × 63 yards.....	252 yards
Change in elevation for a 100-yard change in range (p. 20).....	2.3 mils
1-fork elevation = $\frac{252}{100} \times 2.3$	5.8 mils
Minimum elevation (to nearest mil) 133.1 + 5.8 = 138.9 mils.....	139 mils
Minimum level point range (p. 59).....	10,300 yards
Slope of fall at 10,300 yards (p. 21).....	1/4.3
Minimum map range (to nearest 10 yards) $10,300 + \left(4.3 \times \frac{90}{3}\right) = 10,429$ yards	

Answer: 10,430 yards

d. Landward areas. (1) *Approximate solution.* Batteries in a position to fire landward should determine the areas which cannot be reached because of interfering masks. If the land is level, the problem is the same as that explained in the preceding paragraphs, and any of the methods may be

used providing the difference in elevation between the gun and the target area is known. If the land is not level, certain modifications must be made in the methods used to determine the dead areas. A map, showing 10-foot contours, drawn to a scale of from 1 to 3 inches per mile will usually be satisfactory. Draw rays from the battery position through the critical points and plot the profile along each ray to any convenient scale. Determine the minimum elevations to clear masks. On each profile, plot the minimum level point range and draw at this point the slope of fall given in the firing tables. In constructing the slope of fall, it is important to use the same horizontal and vertical scales used in constructing the profile. The intersection of the slope of fall and the profile will give the minimum map range corresponding to the minimum elevation to clear the mask. The area between the point of minimum range and the mask will be the dead area.

(a) *Example.* A battery of 6-inch guns M1908M1, on barbette carriage and firing 108-lb. AP projectiles (FT 6-C-2), is located as shown on the map in figure 7. Two thousand yards from the battery is a hill requiring a minimum elevation of 31.8 mils to clear the mask. *Determine the minimum range and dead area when firing along the ray GA.*

(b) *Solution.* Draw the profile of the line GA as shown in figure 8. From the firing table, determine the level point range, 3,560 yards, corresponding to the given minimum elevation, 31.8 mils, to clear the mask. On the profile, locate the level point (*L*) at this range. Through this point, draw the line of fall to correspond to the slope of fall which is given in the firing tables as 1 on 27. Notice the difference in size between the horizontal and vertical units. Extend this line of fall to intersect the profile. The range to the point

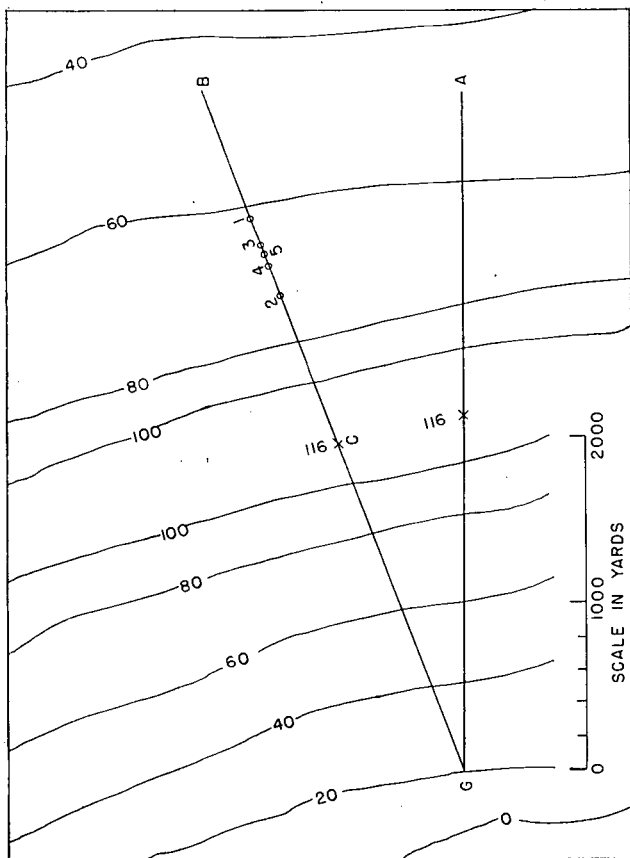

Figure 7. Map for use with examples in paragraph 32d.

of intersection (*I*) is the minimum range and the area between this point and the mask is the dead area.

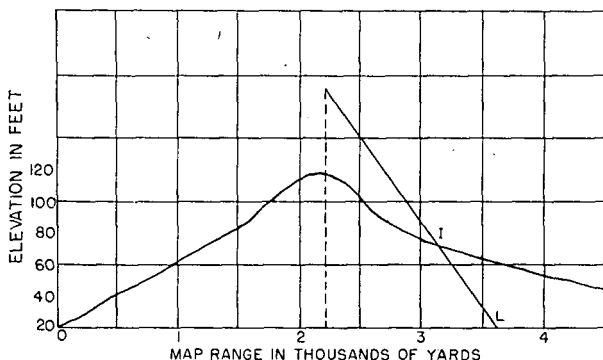

Figure 8. Profile of line *GA* in figure 7.

(c) *Discussion.* This method is only approximate as it is assumed that the trajectory is a straight line at the point of fall which is obviously untrue. If the difference in elevation between the gun and the actual point of impact is small, the error caused by using this method will be negligible. For great differences in elevation, however, the error will be too large to be neglected, in which case the method outlined in the following example will prove more accurate.

(2) *Accurate solution.* If an accuracy is desired greater than that obtainable by the method employed in the example in (a) and (b) above, a solution by trial and error can be used. In this method, usable for either near or distant masks, the rays are drawn as before and the minimum elevation to clear the mask is determined by any convenient method. It will be helpful, but not essential, to draw a profile of the ray under consideration. The level point range corresponding

to the minimum elevation should be determined, and the point on the ray corresponding to this range (to the nearest 500 yards) should be located. The difference in altitude between the battery and this point is determined from the contours or profile and the corrected range for this point is obtained. If this corrected range is less than the minimum level point range, a new trial point is selected at a range greater than the first point, and the difference in altitude and the corresponding corrected range are again determined. This process is repeated until two map ranges are found that differ by 100 yards and give corrected ranges (or elevations) lying on either side of the minimum level point range (or elevation). The minimum map range corresponding to the minimum level point range can then be determined by interpolation.

(a) *Example.* With the same battery given in the example in (1) (a) above, it is desired to locate the dead area along the line *GB* (see fig. 7) if the minimum level point range determined by the masking ridge at point *C* is 3,750 yards.

(b) *Solution.* The problem is to find a map range for which the corrected range will be 3,750 yards. For the sake of convenience in using the firing tables, the first range should be an even 500 yards. In this case, a trial is made at 3,500 yards. The contour map shows that the altitude at 3,500 yards is 42 feet above the gun. The corrected range from the firing tables is 3,880 yards. Since this corrected range is more than the minimum range, a new trial map range of 3,000 yards is taken for which the contour map shows an altitude of 54 feet above gun. The corrected range for this second point is found to be 3,600 yards. Since this latter corrected range is less than the minimum range, a trial map range between 3,500 and 3,000 yards is taken. In this case, 3,300 yards, with a difference in height of site of 46 feet, is

taken and the corrected range is found to be 3,760 yards. This is within 10 yards of the minimum range and if this is considered close enough, the map range of 3,300 yards can be taken as the minimum map range. If greater precision is desired, a new trial range of 3,200 yards with an altitude difference of 49 feet, can be taken and the corrected range of 3,710 yards computed. We now have two map ranges for which the corrected ranges lie on either side of the minimum level point range, and by interpolation between these two map ranges the minimum map range is found to be 3,280 yards. The computations are summarized in the following table:

Minimum firing range = 3,750 yards			
Point No.	Map ranges (yards)	Altitude difference (feet)	Corrected range (yards)
1	3,500	42	3,880
2	3,000	54	3,600
3	3,300	46	3,760
4	3,200	49	3,710
5	3,280 (by interpolation between 3 and 4)		3,750

Section IV. CHART OF FIELD OF FIRE

33. GENERAL. a. A chart of the field of fire of a battery is normally an essential item of equipment. This chart should show distinctly all dead areas, that is, those areas that cannot be reached by fire because of masks, or limitations in the traverse of the guns, or limitations due to the height

of guns above the target. If all dead areas are plotted on the chart, the possibilities of fire may be studied therefrom. The chart should also show enough of the hydrography of the area to indicate the possible routes of enemy approach and maneuver. This information appearing graphically on the plotting board should be of great assistance to the plotter in predicting the future course of an enemy vessel. Furthermore, all distinctive features of the water area, such as lights, buoys, and small islands, should be shown in their proper location.

b. An overlay (carrying the above graphical information) can be drawn to the scale of the plotting board. Each time a fresh piece of plotting paper is put on the plotting board, the overlay can be put down and the features traced upon the plotting paper. Then, when the predicted course of the target enters an area shown as a dead area, the plotter can cease calling out ranges until the target is again in a position which can be fired on. This method is especially applicable to fixed batteries with M3 or M4 plotting boards. However, in batteries having Cloke, M1, or 110° plotting boards, where it may be necessary or desirable to quickly change the orientation of the board, fresh plotting paper showing a different portion of the field of fire must be used each time the board's orientation is changed.

c. A chart of the field of fire (see fig. 9) is ordinarily constructed by drawing rays from the battery at convenient intervals and determining the portions of each ray which cannot be reached by fire from the battery. The ends of these portions are then connected by lines which inclose the various dead areas included in the field of fire. To determine the dead areas on each ray, first construct the range-elevation curve corrected for the particular height of site of the battery from zero range out to the maximum, plotting each 1,000

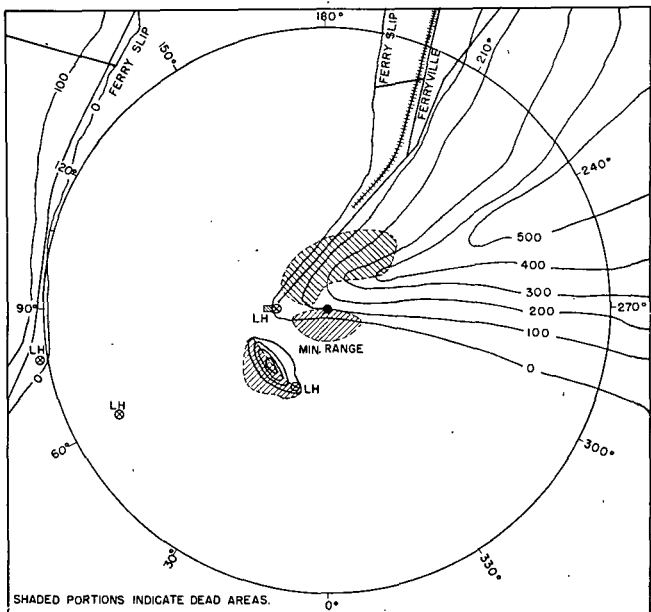

Figure 9. Chart of the field of fire.

yards of range. Determine the minimum elevation along each ray by one of the methods shown in paragraph 30. From the graph, determine minimum ranges corresponding to the minimum elevations. Water areas between the masking obstruction and the corresponding minimum range are dead areas.

d. For batteries prepared to fire to the landward as well as seaward, the chart of the field of fire should include dead areas to the landward. In order to calculate such dead areas, it is necessary to have a map showing contours. Having drawn rays upon it as for water areas, the minimum elevation due to each mask and the resulting mini-

mum map range are calculated by one of the methods explained in paragraph 32. The land between the top of the mask and the computed minimum map range is dead area. The need for including a safety factor of one or two forks in the construction of these charts must be determined for each situation. Where high-angle fire is possible, the dead area may be reduced in some cases by firing at angles of elevation above 45° . This, however, will be an exceptional condition in sea-coast artillery.

CHAPTER 4

ACCURACY OF POSITION-FINDING METHODS

Section I. GENERAL

34. GENERAL. It is important that a battery officer be able to make an analysis of the personnel and materiel elements of the position-finding systems which his battery uses or may be required to use. To do this, he should have a knowledge of—

- a. The capabilities and limitations of all position-finding systems he may be called upon to use.
- b. The possible sources of error.
- c. The measures to be taken to reduce errors to a minimum.

35. CURVATURE AND REFRACTION. a. A knowledge of curvature and refraction is essential to a thorough understanding of the vertical base position-finding system as well as to the solution of problems involving the relation between the height of site of an observer and the maximum range at which he can observe. Because the atmosphere is not completely homogeneous, light rays passing through it are bent very slightly. This bending, called atmospheric refraction, occurs in a vertical plane, the light rays being bent downward. Atmospheric refraction is variable, night refraction being approximately 30 percent greater than day refraction. (See app. III.)

b. Assume that object *T* (fig. 10) is located on the surface of the earth and that, for the moment,

there is no atmospheric refraction. Suppose that an observer located on the line AB wishes to view T from the lowest height possible. Light rays leave T in all directions. The lowest ray leaving T in the

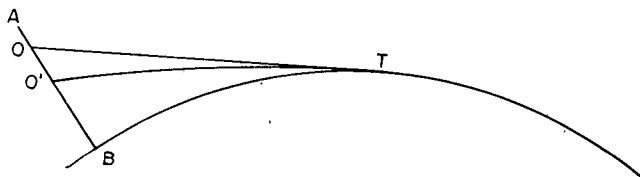

Figure 10. Combined vertical effect of curvature and refraction.

direction of AB is TO , the ray tangent to the surface of the earth at T . Therefore, the lowest point on AB at which the observer can view T is O , and the required height of site, neglecting refraction, is BO . By definition BO is the vertical effect of curvature for the range BT .

c. As refraction causes a downward bending of the light rays, the light ray leaving T tangent to the surface of the earth at T actually follows the path TO' and not the path TO . Since TO' intersects AB at O' , an observer needs only the height of site BO' to see T ; OO' , the difference between the refracted and the unrefracted ray, is called the vertical effect of refraction for the range BT . The difference between the vertical effect of curvature and the vertical effect of refraction is $BO - OO' = BO'$, which is called the combined vertical effect of curvature and refraction for the range BT . The combined vertical effect of curvature and refraction for a given range is therefore the minimum height of site which an observer must have in order to be able to see an object at that range. Moreover, an object at the given range will appear just on the observer's horizon if his height

of site exactly equals the combined effect of curvature and refraction. The combined effect of curvature and average daytime refraction is denoted in this manual by the letter h , and its value for various ranges is given in table I of appendix VI. The average *daytime* refraction is used to determine h , but this value of h is assumed to be true for all conditions. This is satisfactory for all practical purposes. In the absence of a table, the approximate value of h in feet may be determined by the equation:

$$h = .18 R^2$$

where R is the range expressed in thousands of yards.

d. Consider now the solution of a problem involving the height of an observation station necessary to see a target at a given range. If the point to be observed on the target is above the waterline, it may be observed beyond the horizon and the height of this point must be considered.

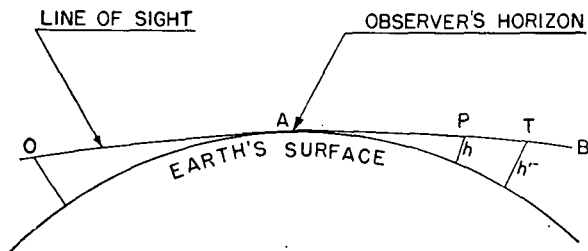

Figure 11. Observation beyond the horizon.

For example, in figure 11, the line of sight to the horizon A of an observer at O may pass beyond A along the path OAB . The height of site of any point P on this line of sight at a range AP beyond the horizon is equal to h for the range AP . Therefore, the range beyond the horizon at which any

target T with a height h' may be seen is AT , the range for which the combined effect of curvature and refraction is h' .

e. Problem. It is desired to determine the height of instrument necessary to track targets at a range of 30,000 yards from the observation station, assuming that the height of the point to be observed on the target is 55 feet above the water. It is desired that the line of sight, at all points, be 5 feet above the water. (See fig. 12.)

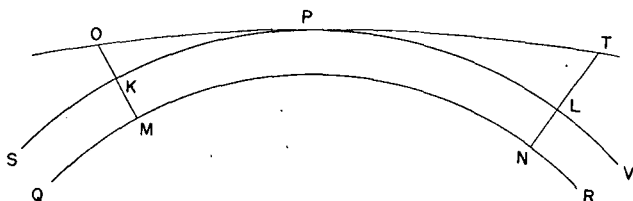

Figure 12. Maximum range of observation.

In figure 12, QR is the surface of the earth, O the observer, and T the observed point of the target. TN is therefore 55 feet. Since it is desired that the line of sight clear the surface of the earth by 5 feet, assume an imaginary sphere SV concentric to QR but 5 feet above it. If SV is considered to be the surface of the earth in solving the problem, a 5-foot clearance of the true surface QR will be assured. At the maximum range of observation, the line of sight TO is tangent to SV at P , and P may be considered to be the horizon. Since SV is 5 feet above QR , LT , the height of T above SV , can be found as follows:

$$\begin{aligned} LT &= NT - NL \\ &= 55 - 5 \\ &= 50 \text{ feet} \end{aligned}$$

Since LT is h for the range PL , PT can be found from table I, appendix VI, as 16,400 yards. The

range OP is therefore 30,000 — 16,400 or 13,600 yards. As KO is h for this range, KO can be determined from table I, appendix VI, as 34 feet. Therefore, the height of site required is KO plus KM , or 34 feet plus 5 feet or 39 feet.

Section II. HORIZONTAL BASE SYSTEM

36. BASE LINES. a. The horizontal base system affords a means of determining the range and azimuth of the target by intersection of the lines of sight from the two ends of a base line of known length and azimuth. These intersecting lines of sight and the base line form a triangle, two angles and one side of which are known. This triangle can then be solved either mathematically or graphically. Since the position of the target is obtained from the solution of a triangle, one of whose sides is the base line of the observation system, it is essential that the length and azimuth of this line and the position of the directing point with respect to this line be determined to within the smallest limits capable of being set on the instruments used in position finding. The orientation data given in the emplacement books, having been computed from measurements made with care and deliberation, are usually listed to the nearest tenth of a yard and the nearest thousandth of a degree. However, the accuracy of position-finding instruments does not warrant such precise calculations. Results to the nearest yard and the nearest hundredth of a degree are sufficiently accurate for position-finding purposes in both fixed and mobile batteries. In these computations, the use of five-place logarithmic tables or of five-place natural function tables will allow this degree of accuracy. It should be remembered that small errors in the determination of the length

and azimuth of a base line may cause errors of considerably greater magnitude in the determination of the position of a target.

b. Accuracy of ranges obtained by the horizontal base system is affected by the magnitude of the angle formed at the target by the lines of site from the two base-end stations. To satisfy the geometrical considerations and to insure the most satisfactory operating conditions of plotting boards and gun data computers, this angle should be not less than 15° or greater than 165° . Proper selection of base lines, of from one-fourth to one-third of the maximum range of the battery in length, will aid greatly in keeping the angle within these limits.

37. OBSERVATION. a. In the horizontal base position-finding system, azimuths of the target from the base-end stations are obtained by the use of azimuth instruments or depression position finders. Accuracy of this determination of azimuths depends on the skill of the observer, his physical condition, the size of the observed point, visibility, and the mechanical accuracy of the instrument. The observer is the greatest source of inaccuracy. He may cause errors by his failure to remove parallax entirely from his instrument, his failure to orient the instrument accurately, or his inability to keep the vertical cross hair precisely on the target at the instant he is making a reading. Thorough training of an observer will reduce these errors to a minimum.

b. A check on the general accuracy of an observer may be obtained by examining a record of his readings on a target moving at constant speed on a straight line. Over short periods of time, the angular travel of the target will be nearly uniform. Therefore, the successive differences between successive readings should not vary greatly.

c. The effect of small errors in the measurement of the azimuths of the target from the base-end stations may be determined mathematically by the equations given in appendix II. However, the effect of these errors on the range and azimuth obtained may also be determined on the plotting board. The position of the target is first plotted with, and then without, these errors in the azimuths to which the arms are set. The differences between the ranges and azimuths to these two positions of the target are then the errors in position finding caused by the small errors in the measured azimuths.

Section III. NOTES ON ACCURACY OF SELF-CONTAINED AND VERTICAL BASE SYSTEMS

38. THE RANGE-FINDING TRIANGLE. In the self-contained and the vertical base position-finding systems, the range (R) to the target is determined by the solution of a right triangle, one leg of which is the base line (b) of the position-finding system. (See fig. 13.) The data for the solution of this triangle are obtained by knowing the length of the base line and by measuring the acute angle (a) between the perpendicular to the base line and the line of sight to the target. Because the base line is extremely short in comparison with the other sides of the triangle (making the angle at the target very small), a small error in the measurement of a will cause a large error in the determination of the range.

39. ERRORS IN OBSERVED RANGES. a. It will be found in actual practice that it is impossible to measure the angle a without error and that, as a

result, the ranges obtained will contain errors corresponding to the errors made in measuring the angle. For example, if an observer makes 10 readings on a fixed datum point at a range suitable for the instrument and these readings are tabulated, it will be found that the readings vary, and that the mean of the 10 readings may be different from the known range to the datum point. Such results indicate the presence of two kinds of errors: systematic errors and accidental errors. (See ch. 6.)

(1) The systematic error is one that is present in all the readings due to faulty adjustment of the instrument or to a constant error on the part of the observer. It will be the difference between the known range to the datum point and the mean of a series of readings. In this instance, the mean of 10 readings is taken. The systematic error can be substantially eliminated by making the prescribed range adjustments in the case of a self-contained range finder, or by proper height of site and refraction adjustments in the case of a depression position finder.

(2) The accidental error is that error present in an individual reading only and is equal to the difference between the individual reading and the mean of all readings. It is caused primarily by the inability of the human eye to distinguish between two objects separated by a very small angular amount. To the eye of even a trained observer, two objects separated by an angular distance of less than 40 seconds of arc appear coincident. Therefore, accidental errors of as much as 40 seconds of arc may be made in gaining coincidence or stereoscopic contact, or in waterlining, even though the adjustment appears perfect to the observer. There will be corresponding range errors for these angular errors. It should be noted that 40 seconds of arc is the maximum error that can be expected from a trained

observer. The mean angular error that may be expected will be considerably less. (See par. 44c.) Accidental errors cannot be eliminated entirely, but may be reduced by proper training of the observer.

b. The effect of magnification is to make smaller angles distinguishable. Theoretically, the smallest distinguishable angle varies inversely as the power of the optical system. In making comparative analyses of angular errors, this theoretical effect of magnification can be assumed to be true. Thus the error of any individual setting of the instrument is taken as the angular error of the observer's eye divided by the magnifying power. A magnification of about 30 power has been found to be the maximum that can be used. Greater magnification causes dullness of the target image and increases the effect of poor atmospheric conditions and vibrations. Except under conditions of excellent visibility, good definition will not be obtained with a 30-power magnification, and it will be necessary to use one of a lower power. As a rule, the better the visibility, the greater is the power of the magnification which may be used advantageously.

c. A mean angular accidental error of 12 seconds of arc is considered the smallest value that can be established by a well-trained observer under perfect conditions of visibility with a stationary target. The maximum error a trained observer is expected to make is 40 seconds. Observers of less ability, under poorer conditions of visibility and with a moving target, may make accidental errors of 60 seconds or more.

40. ACCURACY INDEX OF AN OBSERVER. a. General. Since there is a great difference in the inherent capabilities of observers, it is found of great convenience to establish what is known as the accuracy index of an observer. Represented

by the symbol $\Delta\alpha'$, it is the mean angular accidental error, in seconds of arc, made by the observer in a series of readings referred to a magnification of one (the naked eye). The United States Navy and the Antiaircraft Artillery Command use the U.O.E. (unit of error) as an angular unit of measure for analysis of this type. The U.O.E. is defined as equal to 12 seconds of arc. By calculating the accuracy index of several observers, a comparison of their abilities can be made regardless of variations in length of base or in magnifying power, and to some extent without regard to variations in range, provided the tests made to establish the indexes are conducted under the same conditions of visibility. It should be remembered that although the effect of visibility is cumulative with range and tends to increase errors as the range increases, this fact cannot be taken into account in computing accuracy indexes. Therefore, a comparison of observers by their accuracy indexes obtained at different ranges is not strictly reliable.

b. Computation. An observer's angular accidental errors cannot be observed directly but must be computed from his linear errors which can be determined directly. Hence, in computing an observer's accuracy index (his mean angular accidental error at a magnification of one), it is first necessary to compute his mean linear accidental error at the power of his instrument, and then to convert this to his accuracy index by the equation which relates linear and angular errors for the type of instrument being used. Equation (1) in paragraph 43 is such an equation for an instrument of the self-contained base type. The mean linear accidental error is substituted for ΔR . Under these conditions the resulting value of $\Delta\alpha'$ is termed the accuracy index.

Section IV. ACCURACY OF GUN DATA COMPUTERS AND RADAR

41. GUN DATA COMPUTERS. A gun data computer, when used, replaces the plotting board and ballistic correction devices. It may be employed in a system using a horizontal base, a vertical base, or a radar unit. All data computers used by seacoast artillery are designed to calculate and transmit firing data continuously and instantaneously, thus eliminating dead time. The input data to the computer must also be continuously and instantaneously transmitted. When a horizontal base line system is used, the azimuths from the base-end stations are determined by azimuth instruments or depression position finders equipped with aided tracking devices. The aided tracking device is an attachment which, when fitted to the azimuth instrument M1910A1, or the depression position finder M1, enables the operator to keep the vertical hair on the target by traversing the instrument with a variable speed electric motor. The azimuth at which the instrument is pointed is transmitted instantaneously to the gun data computer by means of an electrical input data transmission system. When radar is used, both the range and the azimuth are transmitted electrically to the gun data computer. When a D.P.F. is used in a single-station system, the azimuth is transmitted continuously but the range is transmitted by voice at regular intervals. The operator at the computer sets a range rate into the instrument to conform as closely as possible to the ranges telephoned from the base-end stations. (See FM 4-15.) When using a horizontal base system, the error in maintaining the vertical hair of the instrument on the target will affect the determination of range in the same manner as when a plotting board is used. (See app. II.) Mechanical errors in the computer are

determined by operational checks outlined in the appropriate technical manuals for the instrument being used and will not be dealt with in this manual.

42. RADAR. The radar sets with which battery officers are concerned are those used for fire control and position finding. (See FM 4-15 for a brief discussion of principles.) These sets, the latest development in position finding, are now supplementing and in time may supplant the older fire-control and position-finding methods. Ordinarily such sets will be used to determine present position data (range and azimuth) for transmission to a plotting board or data computer. The accuracy with which radar equipment can be directed on the target depends on the type of equipment as well as on the skill of the operator. Instruction manuals furnished with equipment should be consulted for detailed information on operational checks. [See also FM 4-95, 4-96, and 4-97 (when published).]

Section V. OBSERVATION WITH COINCIDENCE AND STEREOSCOPIC RANGE FINDERS

43. GENERAL. In effect, the coincidence or stereoscopic range finder determines the range to a target by solving the equation $R = b/\tan a$. From figure 13, it is evident that $\tan a = b/R$, and since a is a small angle, $\tan a$ may be assumed to be equal to angle a expressed in radians, or $a = b/R$. The relationship between the range error (denoted by ΔR) and the observer's corresponding angular error (denoted by $\Delta a'$) in measuring the angle is given by the following equations:

$$\Delta a' = \frac{\Delta R \times b \times M \times 206,000}{R^2} \quad (1)$$

$$\Delta R = \frac{\Delta\alpha' \times R^2}{b \times M \times 206,000} \quad (2)$$

(See app. IV for the derivation of these equations.)

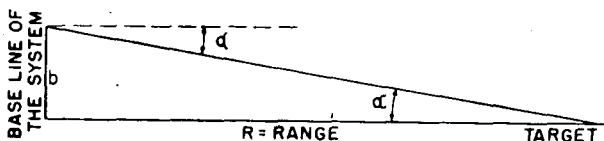

Figure 13. Self-contained base range-finder triangle.

44. FACTORS AFFECTING ACCURACY. a. The accuracy of self-contained range finders, regardless of type, depends principally upon three factors: the virtual base of the instrument; the ability of the observer to determine coincidence or stereoscopic contact; and visibility.

b. The product of the length of the base of an instrument and the power of its magnification is known as the virtual base of the instrument and is used in comparing the accuracy of different types of instruments. It will be noted in equation (2), (par. 43), that the virtual base is in the denominator of the right-hand member, and therefore that the range error caused by a given angular error is inversely proportional to the virtual base of the instrument. Other things being equal, a 30-foot range finder should determine ranges with errors one-half the size of those of a 15-foot instrument of the same magnification. Theoretically, the same principle is true with magnifying power, but in actual practice it is possible to use only such magnification as will allow sharp definition of the image.

c. The ability of an observer to determine coincidence or make stereoscopic contact precisely depends primarily on his eyesight and on his training; but illness, fatigue, or nervousness will cause

variations in his accuracy. The ability of an apt observer may be developed by concentrated effort and training; to maintain a high state of efficiency, the observer must have at least 1 hour of training 3 or 4 days per week. With such training, the average accuracy index should be between 12 and 17 seconds of arc with a stationary target under conditions of excellent visibility. For a moving target, errors of approximately twice these values are to be expected.

d. Visibility plays an important part in range finding by self-contained instruments. When the air is "boiling," the irregular refraction makes observation very difficult. When observing at night with stereoscopic range finders, it will be found that the difference in the intensity of illumination of the target and of the reticle symbols increases the difficulty of accurate observation.

45. COMPUTATION OF ACCURACY INDEX. a. Paragraph b below is an example showing the computation of the accuracy index of an observer using a self-contained base-type of instrument. In the example, the readings were taken on a fixed target, but it should be remembered that the test may also be made using a moving target and that the procedure in using a moving target is different only in the method of calculating the observer's mean linear accidental error.

b. **Example.** Observations were taken with a 15-foot coincidence range finder of 28-power magnification on a fixed point. From the results tabulated below, determine the observer's accuracy index.

Reading No.	Actual range	Observed range	Range error	Systematic* error	Accidental error
1	<i>Yards</i> 9,760	<i>Yards</i> 9,660	<i>Yards</i> -100	<i>Yards</i> -250	<i>Yards</i> 150
2	9,760	9,600	-160	-250	90
3	9,760	9,520	-240	-250	10
4	9,760	9,450	-310	-250	60
5	9,760	9,550	-210	-250	40
6	9,760	9,400	-360	-250	110
7	9,760	9,530	-230	-250	20
8	9,760	9,540	-220	-250	30
9	9,760	9,430	-330	-250	80
10	9,760	9,420	-340	-250	90
Mean	9,760	9,510	-250	68

*The systematic error is found by taking the algebraic mean of the actual errors. The algebraic mean is the sum of the individual range errors divided by the number of readings. In this case, the systematic error is: $-2,500 \div 10 = -250$.

This indicates a mean linear accidental error of 68 yards. Equation (1), (par. 43), is used to convert this to the corresponding angular error at a magnification of one:

$$\Delta\alpha' = \frac{\Delta R \times b \times M \times 206,000}{R^2}$$

$$\Delta R = 68 \text{ yards}$$

$$b = 5 \text{ yards}$$

$$M = 28$$

$$R = 9,510 \text{ yards (the mean observed range)}$$

Therefore: $\Delta\alpha' = 22''$ (expressed to the nearest second). The accuracy index can be computed with sufficient accuracy by substituting the mean actual range for R and this procedure is used in some manuals.

Section VI. OBSERVATION WITH DEPRESSION POSITION FINDER

46. **EFFECTIVE HEIGHT.** a. When observing with a depression position finder, the target in changing range appears to move along the apparent surface of the earth rather than along a line perpendicular to the true base of the instrument. Therefore, the ratio between a small change in range and the corresponding small change in the depression angle is a function of the perpendicular distance AY (see fig. 14) from the instrument to the line YT' drawn tangent to the apparent surface of the earth at the target.

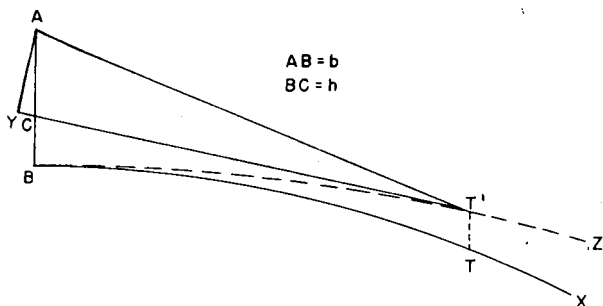

Figure 14. Effective height of instrument.

This is illustrated in figure 14, in which XTB is the earth's surface; $ZT'B$ is the apparent surface of the earth, or the surface as it would appear, due to refraction, to an observer with an instrument at A ; T represents a target; T' is the apparent position of the target; and the line $T'Y$ is tangent to the apparent surface of the earth at T' . Any change in the range of the target will be along line $BT'Z$, which, if the change is small, is equivalent to movement along the tangent $T'Y$. The change in the depression angle for a given small change in range is approximately the same as it would be if

the triangle involved were AYT' or if the height of the instrument were AY . (The angle $AT'Y$ should not be confused with the depression angle.) AC , which, for practical purposes, is equal to AY , is therefore considered to be the effective height of the instrument. Since the apparent horizon of an observer at C would be at T' , BC is the combined vertical effect of curvature and refraction. The effective height of the instrument is therefore equal to the height of the instrument above sea level minus the combined vertical effect of curvature and refraction, or $(b - h)$, where b is the height of the instrument above sea level.

b. From figure 14 it is obvious that as the range increases and the effective height of the instrument decreases, the accuracy of range finding decreases rapidly. This fact is illustrated mathematically in the following equation in which ΔR is the range error in yards caused by an observer's angular error of $\Delta\alpha'$ seconds of arc in waterlining the target. R is the range in yards, M the magnification, and $(b - h)$ is the *effective height in yards*. (See app. III for complete derivation of the formula.)

$$\Delta R = \frac{R^2 \times \Delta\alpha'}{(b - h) \times M \times 206,000} \quad (1)$$

It should be noted that, as in the case of the self-contained base position-finding system, the observer's error in range finding for any given angular error is directly proportional to the square of the range and inversely proportional to the magnification. This equation is the same as equation (2), paragraph 43, except that $(b - h)$ replaces b . It should be noted that effective height applies only to problems involving accuracy.

c. The error in range reading caused by a small change in the effective height in any instrument is considerable. (See app. III.) Since the effective height is constantly changing due to varying tide and refraction, it becomes imperative that

an observer make frequent test readings on known datum points and readjust the height setting of his instrument. At least two datum points, one near maximum range and one at a short range, should be available. These datum points should be objects on which the waterline is clearly defined. The best position for the datum point at short range is not at the minimum range graduation on the range scale of the instrument but at approximately one-third the maximum range. The datum points may be water-borne objects, such as fixed buoys or fixed objects on which the water always registers.

47. FACTORS AFFECTING ACCURACY OF OBSERVATION.

a. The greater the magnification of the telescope, provided the waterline is well-defined, the greater the accuracy that can be obtained. However, since good definition is very important, the highest power eyepiece that may be used will depend on atmospheric conditions.

b. The roughness of the sea has a considerable effect on accuracy, causing a continual variation in the location of the waterline on a target. An endeavor should be made to lay the horizontal wire midway between the highest and lowest position of the waterline.

c. The thickness of the cross wire may cause a considerable error in waterlining. Therefore, the upper edge of the horizontal wire should be used when adjusting the instrument on a datum point and following a target. To accomplish this, the cross wire should be brought to the waterline by a movement in elevation.

d. If the target image is not precisely in the plane of the cross wire, that is, if parallax is not removed by correctly focusing the instrument, large errors in range readings will result.

48. TEST OF ACCURACY OF AN OBSERVER. a.

Previous discussion of the limitations of an observer's eye applies to observers using a depression position finder as well as to those using self-contained range finders. The selection of observers may well be based upon the accuracy index exhibited by each observer in taking long series of readings on either fixed or moving targets. Having determined the observer's mean linear accidental error, the accuracy index may be calculated by the use of equation (2) in b below. In the case of a moving target, the true range must be determined by making a horizontal base plot of the course of the target, and by measuring the range from the observation station to the position of the target at the time each observed range was taken.

b. Example. Observations were taken, using a 25-power D.P.F. with a height of instrument of 120 feet, on a moving target. A tabulation of the results follows on page 84. (See ch. 6, sec. II, for definitions of errors.) This tabulation indicates a mean linear accidental error of 34 yards. Equation (1), paragraph 46b, rearranged, is used to find the corresponding angular error at a magnification of one:

$$\Delta\alpha' = \frac{\Delta R \times (b - h) \times M \times 206,000}{R^2} \quad (2)$$

$$\Delta R = 34 \text{ yards}$$

$$b = 40 \text{ yards}$$

$$h = 6 \text{ yards (from table I, app. VI, entering table with a range of 10,038 yards to the nearest 100 yards)}$$

$$M = 25$$

$$R = 10,038 \text{ yards (the mean observed range)}$$

Therefore: $\Delta\alpha' = 59''$ (expressed to the nearest second). The accuracy index can be computed

with sufficient accuracy by substituting the mean actual range for R and this procedure is used in some manuals. Since the linear range error corresponding to a definite angular error varies nearly in proportion to the square of the range, in cases where the range to the target changes rapidly the readings should be grouped into sets, each covering only a moderate change in range. The angular error of each set is then calculated and the mean is accepted as the observer's accuracy index.

Reading No.	Actual range (by horizontal base)	Observed range	Range error D.P.F.	Systematic* error	Accidental error
1	Yards 10,570	Yards 10,610	Yards +40	Yards +18	Yards 22
2	10,430	10,500	+70	+18	52
3	10,300	10,330	+30	+18	12
4	10,180	10,160	-20	+18	38
5	10,060	10,030	-30	+18	48
6	9,940	9,950	+10	+18	8
7	9,830	9,880	+50	+18	32
8	9,730	9,730	0	+18	18
9	9,630	9,590	-40	+18	58
10	9,530	9,600	+70	+18	52
Sum	100,200	100,380	+180	340
Mean	10,020	10,038	+18	34

*The systematic error is found by taking the algebraic mean of the actual errors. The algebraic mean is the sum of the individual range errors divided by the number of readings. In this case the systematic error is $+180 \div 10 = +18$.

Section VII. PLOTTING BOARDS

49. GENERAL. The plotting board is used to solve graphically a triangulation problem in order that observed positions of the target may be re-located with reference to the directing point of the battery. Proper orientation and accurate mechanical operation of the plotting board are essential to the accurate solution of this problem.

50. CHECK POINTS. a. A check point is an arbitrarily chosen point on the plotting board for which the ranges and azimuths from the base-end stations and the range and azimuth from the directing point are known. The orientation and the mechanical accuracy of a plotting board may be checked by the use of such imaginary datum points. Check points should be located so that they provide a check of each sector of the field of fire at normal range. For example, a 16-inch gun battery with a field of fire of 150° should have a minimum of three check points, one each in the right, center, and left sectors of the field of fire at a range of about 25,000 yards.

b. To check the plotting board by means of a check point, the station arms are set to the azimuths from the base-end stations to the check point and its position is plotted on the plotting board. A comparison of the range and azimuth from the directing point to the plotted position of the check point with the known values will reveal errors in the functioning of the plotting board.

c. Essentially, check points are used to detect large errors in the orientation of a plotting board, and secondly, to reduce the size of errors that may be present due to mechanical faults of the board itself. In checking the orientation of a board, check points are set on the board as stationary targets and the errors tabulated. On boards that

so allow, readjustment of the orientation is accomplished to reduce the errors to a minimum in conformance with uniformity. It should be borne in mind that it is better to have a small but uniform error throughout most of the area covered by the board than to have no error at one spot and a large error at another.

d. The procedure for computing the data for check points is given in the following paragraph.

51. COMPUTATION OF CHECK POINTS. When the coordinates of check points, directing point, and observation stations are known, the range and azimuth between any two of these points may be easily calculated. The following equations may be used:

$$\tan \beta = \frac{\Delta X}{\Delta Y}$$

where β is the bearing angle (the acute angle which a line connecting two points makes with the Y-axis), and ΔX and ΔY are the differences between the respective X and Y coordinates of the two points in question. The azimuth may therefore be determined since it is a function of the bearing angle depending on the quadrant.

$$R = \frac{\Delta X}{\sin \beta} = \frac{\Delta Y}{\cos \beta}$$

where R is the range. It should be remembered that when military grid coordinates are used, ΔY must be corrected for magnification of scale. If local plane coordinates are used, no correction is made. If coordinates of the elements of a battery are unknown, coordinates of an origin may be assumed and the coordinates of the elements computed.

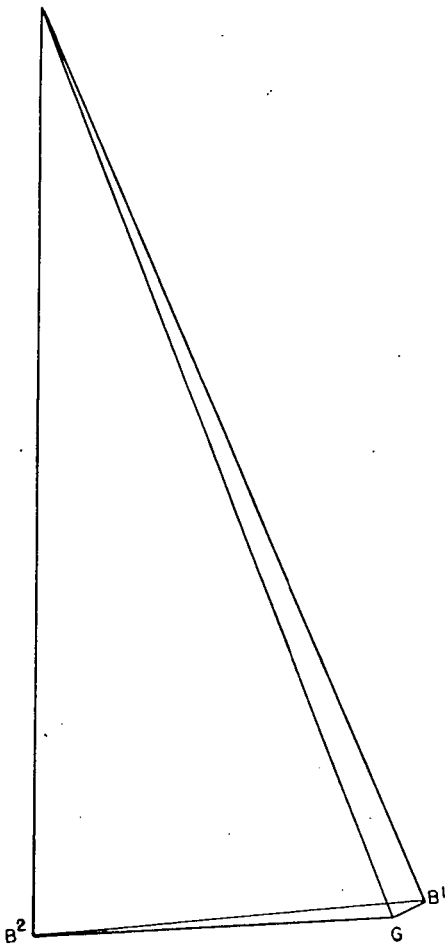

Figure 15. Sketch for problem (par. 51a).

a. Example. Given the following local plane coordinates:

<i>Point</i>	<i>X Yards</i>	<i>Y Yards</i>
B^1	79,622.0	82,905.0
B^2	72,134.9	84,273.0
G	78,979.8	82,898.0
T	76,632.0	102,408.0

Compute the range and azimuth from the observation stations and the directing point G to the check point T . The azimuth reference line is grid south.

b. Solution. (See fig. 15.)

	<i>X Yards</i>		<i>Y Yards</i>
B^1	79,622.0		82,905.0
T	<u>76,632.0</u>		<u>102,408.0</u>
ΔX	2,990.0	ΔY	19,503.0
B^2	72,134.9		84,273.0
T	<u>76,632.0</u>		<u>102,408.0</u>
ΔX	4,497.1	ΔY	18,135.0
G	78,979.8		82,898.0
T	<u>76,632.0</u>		<u>102,408.0</u>
ΔX	2,347.8	ΔY	19,510.0

$$\begin{aligned} \tan \text{ bearing } B^1T &= \frac{2,990.0}{19,503.0} \\ \log 2,990.0 &= 3.47567 \\ \log 19,503.0 &= 4.29010 \\ \log \tan \text{ bearing} &= \overline{9.18557} - 10 \\ \text{bearing } B^1T &= \text{N } 8.72^\circ \text{ W.} \\ \text{azimuth } B^1T &= 180.00^\circ - 8.72^\circ \\ &= 171.28^\circ \end{aligned}$$

$$\begin{aligned} \tan \text{ bearing } B^2T &= \frac{4,497.1}{18,135.0} \\ \log 4,497.1 &= 3.65293 \\ \log 18,135.0 &= 4.25852 \\ \log \tan \text{ bearing} &= \frac{9.39441}{-10} \\ \text{bearing } B^2T &= \text{N } 13.93^\circ \text{ E.} \\ \text{azimuth } B^2T &= 180.00^\circ + 13.93^\circ \\ &= 193.93^\circ \end{aligned}$$

$$\begin{aligned} \tan \text{ bearing } GT &= \frac{2,347.8}{19,510.0} \\ \log 2,347.8 &= 3.37066 \\ \log 19,510.0 &= 4.29026 \\ \log \tan \text{ bearing} &= \frac{9.08040}{-10} \\ \text{bearing } GT &= \text{N } 6.86^\circ \text{ W.} \\ GT &= 180.00^\circ - 6.86^\circ \\ \text{azimuth} &= 173.14^\circ \end{aligned}$$

$$\begin{aligned} \text{range } B^1T &= \frac{2,990.0}{\sin 8.72^\circ} \\ \log 2,990.0 &= 3.47567 \\ \log \sin 8.72^\circ &= \frac{9.18072}{-10} \\ \log \text{ range} &= \frac{4.29495}{-10} \\ \text{range } B^1T &= 19,721.8 \text{ yards} \end{aligned}$$

$$\begin{aligned} \text{range } B^2T &= \frac{4,497.1}{\sin 13.93^\circ} \\ \log 4,497.1 &= 3.65293 \\ \log \sin 13.93^\circ &= \frac{9.38154}{-10} \\ \log \text{ range} &= \frac{4.27139}{-10} \\ \text{range } B^2T &= 18,680.4 \text{ yards} \end{aligned}$$

$$\begin{aligned} \text{range } GT &= \frac{2,347.8}{\sin 6.86^\circ} \\ \log 2,347.8 &= 3.37066 \\ \log \sin 6.86^\circ &= \frac{9.07716}{-10} \\ \log \text{ range} &= \frac{4.29350}{-10} \\ \text{range } GT &= 19,656.4 \text{ yards} \end{aligned}$$

CHAPTER 5

POINTING

Section I. CANT

52. GENERAL. a. Cant is the inclination from the horizontal of the trunnions about which a gun is rotated for pointing in elevation. If these trunnions are not level, the axis of the bore will not remain in a vertical plane as the gun is elevated. This will change the azimuth at which the gun is pointing, the change being toward the low end of the trunnions. At the same time, it will cause an error in the quadrant elevation if the angle through which the gun has been elevated was not measured in a vertical plane. This latter error is, however, negligible for angles of inclination less than 4° . (See par. 122.)

b. The magnitude of the effect of cant depends on the inclination of the axis of the trunnions and the quadrant angle of elevation. If the inclination is denoted by I , the quadrant elevation by ϕ , the angular error of pointing in direction by d_1 , then:

$$\tan d_1 = \sin I \tan \phi$$

Due to the small size of the angles d_1 and I , this formula can be simplified to:

$$d_1 = I \tan \phi$$

The latter formula is the one generally used. (See app. V for the derivation of these two formulas.)

(1) *Example.* The trunnions of a 155-mm gun are canted 45 minutes (0.75°) when the gun is

pointed at the center of the field of fire. The maximum quadrant elevation is 35° . Is the cant going to cause an error in direction which will be too large to disregard?

(2) *Solution.* By the true formula:

$$\begin{aligned} \tan d_1 &= \sin I \tan \phi \\ \tan d_1 &= \sin 0.75^\circ \tan 35^\circ = 0.00917 \\ d_1 &= 0.525^\circ \text{ or } 0.53^\circ \end{aligned}$$

By the simplified formula:

$$\begin{aligned} d_1 &= I \tan \phi \\ d_1 &= 0.75^\circ \tan 35^\circ = 0.525^\circ \text{ or } 0.53^\circ \end{aligned}$$

This error is too large, and a correction is necessary.

(3) *Example.* The base ring of a 16-inch gun on a barbette carriage has settled so that the trunnions are canted 3 minutes (0.05°) when firing at an azimuth of 270° . The right trunnion is higher than the left. The maximum value of ϕ is 47° . Is a deflection correction for cant necessary?

(4) *Solution.*

$$\begin{aligned} d_1 &= I \tan \phi \\ d_1 &= 0.05^\circ \times \tan 47^\circ = 0.05^\circ \times 1.07 = 0.05^\circ \end{aligned}$$

A correction is necessary.

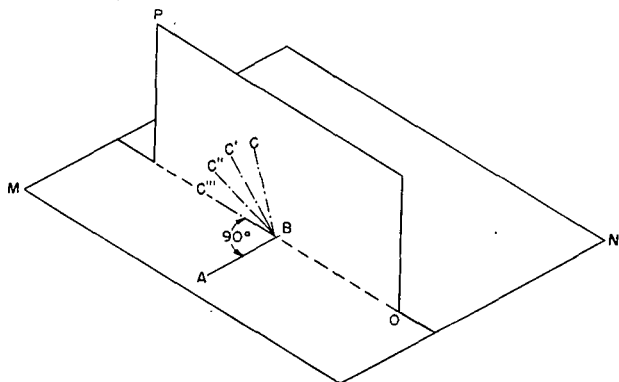

Figure 16. Illustration for paragraph 53.

53. ANALOGY. If one side AB of a right angle ABC (see fig. 16) lies in a given plane MN , the other side BC of the angle will lie in a plane OP passing through B and perpendicular to the plane MN and to the line AB . This is true for all positions of the line BC with respect to the given plane. As BC rotates about AB , the projection of BC (BC'') on the plane MN will be perpendicular to AB . To apply this to artillery, the plane MN under discussion is the horizontal plane in which the azimuths of pointing are measured. The line AB which lies in the plane MN represents the axis of the trunnions. The line BC represents the axis of the bore,* which is free to rotate around the trunnions. From this, it will be seen that the projection of the bore on the plane MN containing the trunnions will always be 90° from the trunnions. When this plane is horizontal, the projection will not change direction as the gun is elevated. This can be illustrated by placing a 30, 60-degree draftsman's triangle flat on a table next to a vertical wall in such a position that the long side of the triangle is in contact with the wall. In this position, the short side will be perpendicular to the wall. If the triangle is now rotated around the short side, the long side will stay in contact with the wall. In this case, the short side represents the trunnions, the long side the bore, and the wall the plane of fire. If a small object such as a pencil is placed under the end of the short side nearer the wall, and the triangle is again rotated around the short side in its inclined position, it will be seen that the long side of the triangle no longer follows the wall but moves away from it as the triangle is elevated. This illustrates the effect of cant of the trunnions.

*To simplify the discussion in this chapter, the axis of the bore will henceforth be called the bore and the axis of the trunnions will be called the trunnions.

54. CORRECTIVE MEASURES. As fixed sea-coast guns are mounted on permanent platforms, the carriages, and consequently the trunnions, are level or nearly level. The sight mount for a fixed sea-coast gun is rigidly attached to the carriage. Upon assembly to the carriage, the mount is so adjusted that the sight which it supports will read horizontal angles and, if required, vertical angles. If a deflection is set on the sight and the gun traversed until the line of sight includes the target, the trunnions are given a definite direction. The projection of a right angle upon a horizontal plane is a right angle, provided one side of the right angle is horizontal. (See par. 53.) Since the bore is always perpendicular to the trunnions, the bore will always point in an azimuth differing by 90° from the trunnions if the trunnions are level. The bore, therefore, will have a fixed direction with respect to the line of sight regardless of the angle of elevation. Since mobile guns are seldom mounted on level platforms, the sight mounts for this materiel include means for establishing a horizontal line perpendicular to the bore and for giving that line a definite direction. These instruments are called compensating sight mounts.

Section II. COMPENSATING SIGHT MOUNTS

55. CONSTRUCTION. a. There are several types of compensating sight mounts issued for use with mobile guns. They differ somewhat in the details of construction but are all similar in one respect, that is, in the use of a cross (see fig. 17). For purposes of identification, the arms of this cross are called the long axis and the short axis. The sight mount is attached to the gun or carriage so that the long axis is maintained parallel to the bore. This is accomplished either by attachment

through a bracket to a gun trunnion or by means of a linkage between the long axis and the trunnion. In constructing the cross, the short axis is made perpendicular to the long axis. Unless the cross is damaged the short axis will always be perpendicular to the long axis. The sight shank is mounted on, and perpendicular to, the short axis in such a manner that it can be revolved around the short axis. The sight in turn is mounted on the shank in such a position that the vertical axis of the sight is always perpendicular to the short axis. Two levels are attached to the sight shank, one parallel to the short axis and the other perpendicular to it. The levels are perpendicular to each other and to the axis of the sight shank. By means of these levels, the short axis may be maintained horizontal and the sight shank vertical. The short axis is leveled by rotating the cross around the long axis, regardless of the angle of elevation of the bore, until the level bubble parallel to the short axis is centered. The shank is made vertical by rotating it about the short axis until the other level bubble is centered. Thus we have a means for establishing a horizontal line (short axis) perpendicular to the long axis (and therefore perpendicular to the axis of the bore) regardless of the angle of elevation of that axis, and a means for giving this line a definite direction.

b. If the gun is elevated when the trunnions are canted, the long axis of the cross will likewise be elevated and pulled away from its original azimuth. The short axis will be rotated through a horizontal angle equal to that swept through by the long axis of the cross and the axis of the bore. Since the sight shank is mounted on the short axis in such a manner that it may be maintained vertical, the line of sight will be traversed through the same horizontal angle as the short

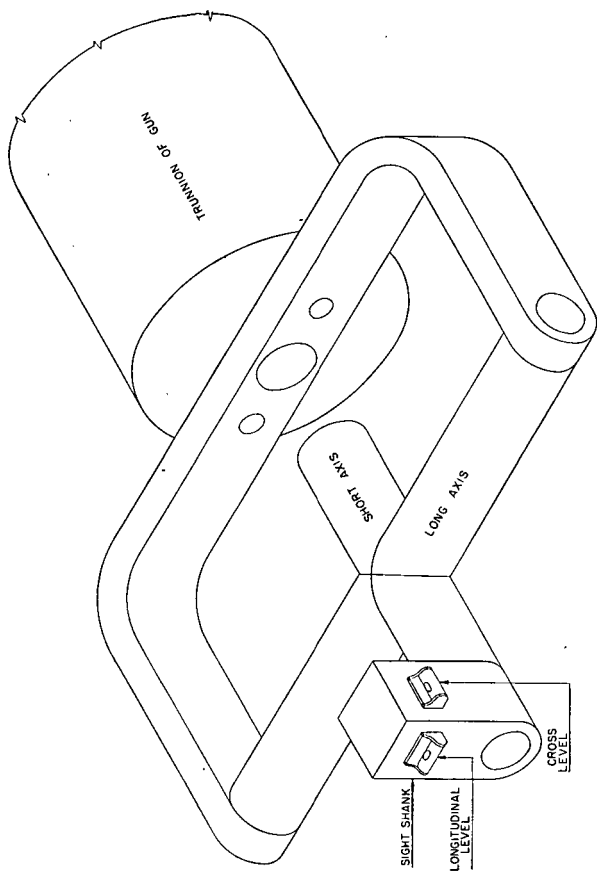

Figure 17. Cross in compensating sight, schematic sketch.

axis. Then by traversing the gun until the line of sight is back on the aiming point, the gun is brought back to its original azimuth. This can be explained geometrically by means of figure 18. (See c below.)

c. In figure 18, OB represents the inclined trunnions of the gun while OE represents the bore in the horizontal position. JH represents the long axis of the cross, and JK represents the short axis of the cross when the gun is horizontal. As the gun is elevated, the bore will move in the plane $OECF$ to a position such as OC . The horizontal projection of the bore in the elevated position is OF , showing that the gun has moved to the right by an amount equal to the angle EOF . Since the long axis of the cross is always parallel to the bore, it will also have to move to the right and be elevated to a position JI . If the short axis is made to stay in the horizontal plane $KOEL$, it will move to a new position JM . The angle KJM will be equal to the angle HJG , and both will be equal to the angle EOF . If the gun is now traversed to the left so that it lies in the vertical plane $OEDA$, the long arm of the cross will be rotated through the angle HJG to lie in the vertical plane $JHNQ$; and the short axis of the cross, if kept level, will be moved back to its original position JK . If the panoramic sight is pointed at the aiming point when the short axis lies along JK , the panoramic sight will point to the right of the aiming point when the short axis lies along JM , and the angular difference will be equal to the angle MJK , which it was noted is equal to EOF . If the gun is to be traversed so that the sight is brought back on the aiming point, it will be necessary to move the gun to the left enough to bring the short axis back onto the line JK and therefore enough to bring the bore into the vertical plane $OEDA$, thus correcting for the error due to cant.

56. SOURCES OF ERROR. It is obvious that in a properly adjusted sight mount of the compensating type, the leveling mechanisms perform two important functions. When the bubbles are centered, they establish a horizontal plane parallel to the axes of the levels. This results in making the short axis horizontal and in making the sight

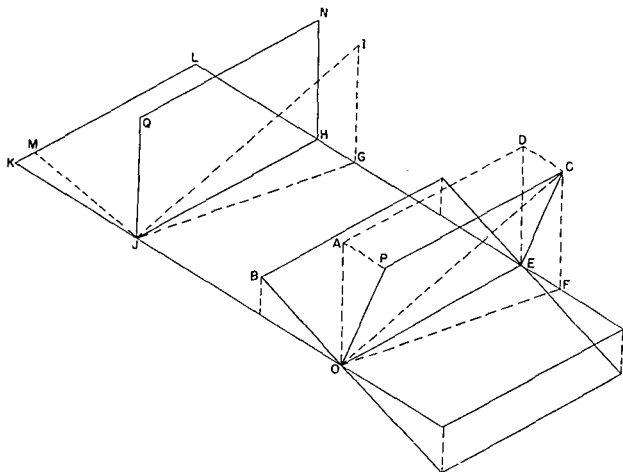

Figure 18. Correction for cant by compensating sight.

shank vertical. The first function compensates for cant and is by far the more important. The second function merely assures the measurement of horizontal angles on which small errors in the verticality of the sight will have little effect unless the aiming point is at a considerable angle above or below the sight. Some of the maladjustments of the sight mounting which may cause errors are:

- a. Levels out of adjustment (the most likely source of error).
- b. Sight shank loose or bent.

c. Sight bracket distorted or improperly assembled.

d. Members of the cross not perpendicular to each other.

57. CROSS LEVEL OUT OF ADJUSTMENT. a. The effect of the cross level being out of adjustment is to introduce a cant into the cross of the compensating sight. The analysis of this error is given in figure 19 and in the following discussion. If the cross-level bubble is in correct adjustment, the short axis will be horizontal when the bubble is centered. If the bubble is not in adjustment, the short axis will be inclined at a constant angle to the horizontal plane when the bubble is centered. The error in pointing due to the cross level being out of adjustment is shown in figure 19. In this case, the gun is assumed to be emplaced so the trunnions are level, and the long axis is assumed to be always parallel to the bore of the gun. In the figure, OA represents the position of the long axis when the bore is in the horizontal position. OC is the position of the short axis when the bore is in the horizontal position. It can be seen that owing to the maladjustment of the cross level, the short axis is inclined away from the horizontal an amount equal to the angle COE . If the gun is elevated, the long axis will be elevated also in the vertical plane and will assume a new position such as OB . At the same time the short axis will move rearward to a new position, such as OD . If, during this movement, the cross-level bubble is kept centered, the short axis will maintain a uniform inclination in relation to the horizontal plane. This inclination will be equal to the angle COE . Because of this movement the short axis will have moved along the surface of a cone, the axis of which is OF and one element of which is OC . However, for very small movement of the short axis along this cone, it will be sufficiently

accurate to assume that the new position of the short axis will be in the inclined plane $GAIH$ and will take the position OD . It will be seen that if the sight is on the aiming point when the short axis is in the position OC , it will move away from the aiming point when the short axis moves to OD . The line of sight will move in the same direction as the short axis. In this case the left end of the short axis is high, and the short axis has moved in a counterclockwise direction from the position OC . Therefore, the line of sight will also move counterclockwise and fall to the left of the aiming point. When the left end of the short axis is high, the line of sight moves to the left of the aiming point when the gun is elevated. Bringing the line of sight back onto the aiming point causes the gun to be moved to the right. From this, it can be seen that when the right end of the short axis is low, the error in pointing the gun is to the right. When the right end of the short axis is high, the line of sight will move to the right and, therefore, the error in pointing the gun will be to the left. The movement of the short axis as the gun is elevated may be demonstrated by taking a right

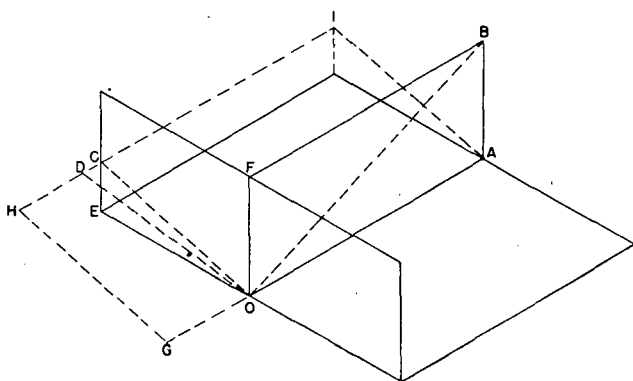

Figure 19. Effect of cross level out of adjustment.

angle (draftsman's triangle) and elevating one side of the right angle through a vertical plane (by sliding along a vertical wall) while the other side of the right angle is *not* horizontal.

b. If the bore is not parallel to the long axis, the entire principle of the compensating sight mount is violated and the center line of the bore at any angle of elevation will be parallel to an element of a cone whose axis coincides with the short axis of the cross. The magnitude of the resulting error in pointing (see note) depends on the quadrant elevation and the amount of divergence between the axis of the bore and the long axis of the cross. If the lack of parallelism is appreciable, it will become apparent when trying to readjust the cross-level bubble. (See pertinent Technical Manuals.) If this condition is found, it will be necessary to refer the matter to Ordnance for repair.

NOTE. If d_L denotes the angular error of pointing due to lack of parallelism, then:

$$d_L = L \operatorname{exsec} \phi$$

in which L is the angular value of the lack of parallelism in degrees and ϕ is the quadrant elevation. If tables of external secants are not at hand, $\operatorname{exsec} \phi$ may be expressed as $\frac{1}{\cos \phi} - 1$.

58. METHOD OF CHECKING ADJUSTMENT OF CROSS-LEVEL BUBBLE.

a. The Ordnance Department has a very accurate method of checking the cross-level bubble of the sight mount by actually leveling the trunnions of the gun and thus making the bore follow a vertical plane and remain at the same azimuth while being elevated.

b. Satisfactory results can be obtained in the field by causing a vertical cross hair on the muzzle of the gun to follow a plumb line as the gun is elevated. The operation of checking the cross-level bubble using this system is as follows:

(1) Place a cross hair on the vertical center line of the muzzle.

(2) Establish a plumb line in front of the muzzle. The plumb line should be shielded from wind and the plumb bob should hang in a bucket of oil to dampen the swaying caused by wind.

(3) With the bore approximately horizontal, boresight the gun on the plumb line.

(4) Center both the longitudinal level and the cross level on the sight mount.

(5) Move the sight head, placing the line of sight on a distant aiming point.

(6) Elevate the gun as high as possible to magnify any error that may be present and again boresight on the plumb line, traversing the gun if necessary. It may then be observed that the short axis rotates in the direction of the *high* end of the short axis. If the gun is now traversed to bring the line of sight back on the aiming point, it will introduce an error in azimuth. As the long axis of a compensating sight mount is assumed to be parallel to the bore, the error in pointing in direction due to failure to level the short axis is the same as for a corresponding inclination of the trunnions, that is (by the simplified formula):

$$d_1 = I \tan \phi$$

(7) Check level of sight, releveled if the bubbles are not centered.

(8) Check position of the line of sight. If it is on the aiming point, this is an indication that the level bubble is properly adjusted. If it is not on the aiming point, the cross-level bubble is out of adjustment and must be readjusted. (In exceptional cases, it may be that the sight mount in some way has been damaged.) If the left end of the short axis is low, the line of sight is to the right of the aiming point; and if the right end of the short axis is low, the line of sight is to the left

of the aiming point. It follows, therefore, that in normal operation of the sight, if the gun is fired with the left end of the short axis low, the error in pointing is to the left; if the right end is low, the error in pointing is to the right.

c. An alternate method, which is fundamentally the same as the plumb line system, is the transit system. The procedure for this method is as follows:

(1) Place cross hairs on the horizontal and vertical center lines of the muzzle.

(2) Set up a transit (which must be in good adjustment) about a hundred feet in front of the gun so that the transit telescope is at approximately the same level as the axis of the bore at zero elevation; then carefully level the transit.

(3) Boresight the gun on the transit, making the final adjustment by sighting through the transit telescope.

(4) Center both longitudinal and cross levels on the sight mount.

(5) Move the sight head and place the line of sight on a distant aiming point.

(6) Elevate the gun to maximum elevation to magnify as much as possible any error which may be present. Elevate the transit telescope and have the gun traversed until the intersection of the muzzle threads coincides with the vertical cross hair in the transit.

(7) Check level of sight, releveling if the bubbles are not centered.

(8) Check position of line of sight. The results of this method will be the same as those mentioned in the plumb line system.

59. EXAMPLES. a. **Example 1.** (1) The cross level on the sight mount of an 8-inch railway gun is out of adjustment. When the bubble is centered, the short axis of the sight mounting is 20 minutes (0.33°) out of level, the right end being low. The

sight mounting is otherwise correctly adjusted. *What will be the lateral effect on a shot fired at an elevation of 450 mils?*

(2) *Solution.*

$$d_1 = I \tan \phi$$

Upon substitution of the given values:

$$d_1 = 0.33^\circ \times \tan 450 \text{ mils} = 0.33^\circ \times 0.473 = 0.16^\circ$$

Since the right end of the short axis is low, the effect will be 0.16° to the right.

b. Example 2. (1) The cross level on the sight mount of a 155-mm gun is out of adjustment. When the bubble is centered, the short axis is 25 minutes out of level, the left end being low. The trunnions are also canted 35 minutes, the right end being low. *What will be the lateral error of a shot fired at an elevation of 550 mils?*

(2) *Solution.* The compensating sight mount will correct for the cant of the trunnions. All that need be considered is the error of the inclination of the short axis.

$$d_1 = I \tan \phi$$

Substituting the values given:

$$\begin{aligned} d_1 &= 25 \tan 550 \text{ mils} = 25 \times 0.599 \\ &= 15 \text{ min. or } 0.25^\circ \end{aligned}$$

Since the left end of the short axis is low, the effect will be 0.25° to the left.

c. Example 3. (1) In checking a compensating sight mount by the plumb line system, it was found that when the gun was elevated from 0 mil to 600 mils the line of sight moved 0.20° to the left of the aiming point. The level bubbles were centered properly during the test. *What is the magnitude of the inclination of the short axis? Which end is low?*

(2) *Solution.*

$$d_1 = I \tan \phi$$

$$I = \frac{d_1}{\tan \phi}$$

Substituting the given values:

$$I = \frac{0.20^\circ}{\tan 600 \text{ mils}} = \frac{0.20^\circ}{0.668} = 0.30^\circ$$

Since the line of sight moved to the left of the aiming point, the right end of the short axis is low. (See par. 57.)

Section III. SELECTION OF AIMING POINTS

60. GENERAL. Guns in fixed emplacements which are to be fired by case III methods are equipped with fixed azimuth circles. In mobile artillery, however, an oriented azimuth circle is usually not available for pointing the gun in direction. To provide a means of pointing a mobile gun in direction, a reference line is established and the gun is pointed by turning off an angle from that reference line. The reference line is marked on the ground by a distant structure or natural object, such as a tree, lighthouse, pole, or stake, which is called the aiming point. This is discussed in greater detail in FM 4-15.

61. ERRORS ARISING FROM USE OF AIMING POINT. **a. General.** If the panoramic sight were mounted directly above the pintle center of the gun, there would be no error in pointing caused by the use of the aiming point; but since the sight is always displaced an appreciable distance from the pintle center, consideration must be given to the error that arises under certain conditions. In orienting, the bore of the gun is pointed at a known azimuth, the sight is turned to the aiming point, and the azimuth scale of the sight is slipped to read the azimuth of the bore. This is known as the orienting position. The line joining the sight and the aiming point is the only reference line for the setting of azimuths and will be called the base

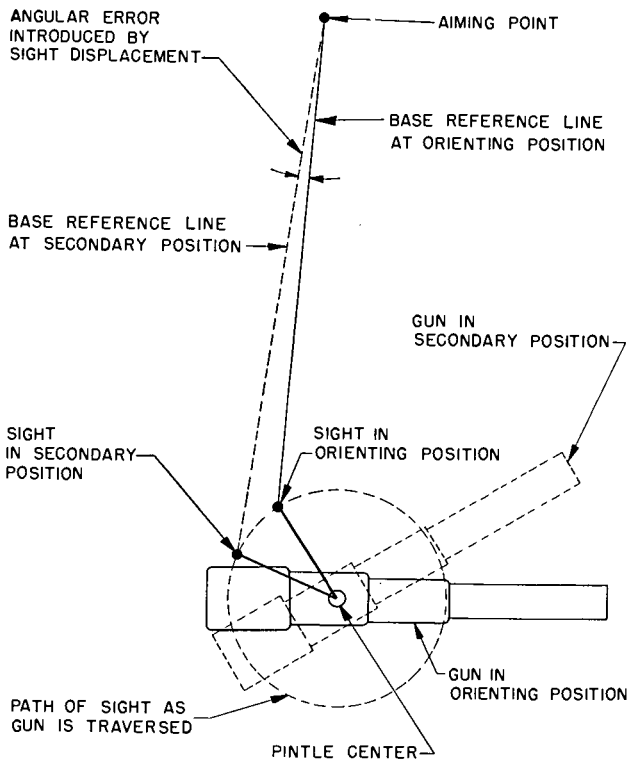

Figure 20. Aiming point error.

reference line hereafter. It should be noted that this is not the north-south line to which azimuths are referred.

b. Causes of error. The error caused by the use of an aiming point is due to the following factors:

(1) All azimuths are referred to the base reference line.

(2) As the gun is traversed, the sight and sight mount will revolve around the pintle center of the gun thus causing an angular shift in the base reference line.

(3) The error in pointing is caused by and is equal in amount and direction to the angular shift of the base reference line away from its position when the sight was oriented.

(4) *Example.* A certain azimuth is set on an oriented sight. The gun is then traversed until the sight is centered on the aiming point. The base reference line, as viewed from the aiming point, has shifted direction to the left 0.03° from its orienting position. Therefore the bore of the gun will be pointed 0.03° to the left of the azimuth set on the sight.

c. Factors determining maximum error. The factors affecting the maximum error to be expected with any given gun are:

(1) The relation between the orienting azimuth, the azimuth to the aiming point, and the angle muzzle-pintle center-sight.

(2) The relation of the boundary azimuths of the field of fire to the orienting azimuth.

(3) The distance to the aiming point (an aiming point at an infinite distance would give no error whatsoever).

62. DETERMINATION OF AMOUNT OF AIMING POINT ERROR. a. To determine (quantitatively) the sight displacement error at any azimuth of the gun for an aiming point of given

azimuth and distance, apply the following procedure:

(1) *Step 1.* Draw a schematic sketch of the gun, sight, and aiming point showing the sight in the orienting position (at which position there is no error) and the sight in the secondary position for which the error is to be computed. (See fig. 21.)

(2) *Step 2.* Compute the effective sight displacement for each position of the sight. The effective sight displacement (ESD) is the perpendicular distance from the sight to the line pintle center-aiming point. In order to evaluate the effective sight displacement, it is necessary to know the sizes of angles A_1 and A_2 . Knowing the azimuths of the bore of the gun and the constant angle sight-pintle center-muzzle, the azimuths of the lines from the pintle center to the two positions of the sight are obtained. Since the azimuth from the pintle center to the aiming point is given, the sizes of the A angles are readily computed. By multiplying the amount of actual sight displacement (distance from the pintle center to the sight) by the sine of each angle A , the effective sight displacement for each position of the sight is obtained.

(3) *Step 3.* To compute the value of the error caused by sight displacement, the two effective sight displacements just found must be combined by either addition or subtraction, according to the following rule: If the secondary position of the sight is on the same side of the line pintle center-aiming point as the orienting position of the sight, take the difference between the effective sight displacements; if the secondary position of the sight is on the opposite side of the line pintle center-aiming point, take the sum of the effective sight displacements.

(4) The result of the third step is the length of the chord subtending the angle of error at the

aiming point. Knowing the distance to the aiming point, we can solve for the error by using the mil rule, or its equivalent for degrees. Thus:

$$\text{Error in mils} = \frac{ESD_1 \pm ESD_2 \times 1,000}{d}$$

$$\text{Error in degrees} = \frac{ESD_1 \pm ESD_2 \times 57}{d}$$

where ESD_1 and ESD_2 are the effective sight displacements explained in step (3), and d is the distance to the aiming point.

(5) As already mentioned, the direction of the error, whether right or left, may be determined by

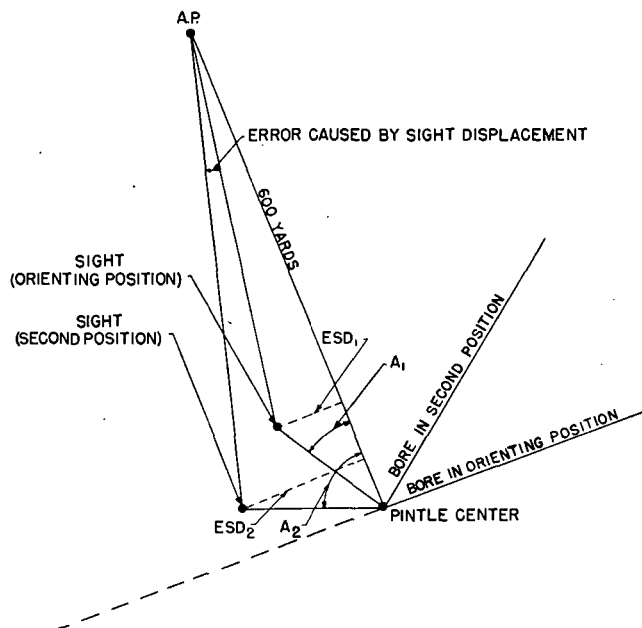

Figure 21. Computation of aiming point error.

inspecting the shift of the base reference line as the sight swings away from the orienting position.

(6) If it is desired to compute a minimum distance to an aiming point at a particular azimuth, solve for the effective sight displacement as before, substitute the maximum error allowable (never more than 0.03°) in the formulas above, and determine d .

b. Example. A 155-mm gun G.P.F. is oriented by boresighting at 180° azimuth and turning the sight on an aiming point at 600 yards whose azimuth is 90° . The angle muzzle-pintle center-sight is 118° and the actual displacement of the sight from the pintle center is 24 inches or 0.67 yard. *What is the error in pointing caused by sight displacement when the gun is pointed by setting the sight at 140° and traversing the gun until the line of sight is on the aiming point?*

c. Solution.

(1) For sketch, see figure 21.

(2) Following are the steps in the solution of the effective sight displacement in the orienting position and the second position:

(a) In the orienting position:

Azimuth of bore.....	180°
Angle muzzle-pintle center-sight.....	<u>118°</u>
Azimuth of line pintle center-sight.....	62°
Azimuth of aiming point.....	90°
Azimuth of line pintle center-sight.....	<u>62°</u>
Angle A_1 (difference).....	28°

$$\text{E.S.D.} = \text{actual sight displacement} \times \sin A_1$$

$$\text{Actual sight displacement} \dots\dots\dots 0.67 \text{ yard}$$

$$\text{Sin } 28^\circ \dots\dots\dots 0.469$$

$$\text{E.S.D.}_1 = 0.67 \times 0.469 = 0.31 \text{ yard}$$

(b) In the second position:

Azimuth of bore*.....	140°
Angle muzzle-pintle center-sight.....	118°
Azimuth of line pintle center-sight.....	22°
Azimuth of aiming point.....	90°
Azimuth of line pintle center-sight.....	22°
Angle A_2 (difference).....	68°
Actual sight displacement.....	0.67 yard
Sin 68°.....	0.927
E.S.D. ₂ = 0.67 × 0.927 = 0.62 yard	

*This azimuth is only approximate. For the purpose of computing effective sight displacement, the aiming point error has been ignored.

(3) Since the two positions of the sight are on the same side of the line pintle center-aiming point, take the difference between the effective sight displacements for substitution in the formula.

(4) The error in degrees is:

$$\frac{(0.62 - 0.31) \times 57}{600} = 0.0295 \text{ or } 0.03^\circ$$

(5) That the error is to the right may be judged by inspection of the shift of the base reference line.

(6) If it were desired to determine the distance to an aiming point at the same azimuth of 90° which would give an error of only 0.01° for the same position of the bore, then the substitution in the formula would be:

$$0.01^\circ = \frac{(0.62 - 0.31) \times 57}{d}$$

and the distance (d) would be 1,767 yards. In any case the maximum error should not exceed 0.03° as pointed out in subparagraph a preceding.

63. SELECTION OF AIMING POINT. The selection of aiming points is an important part of the preparation for fire of mobile coast artillery units

using case III pointing and not equipped with aiming rules. The principal factors influencing the battery officer in selection of aiming points are visibility and the permissible pointing error.

a. Visibility. Aiming points must be visible from the guns. The factors affecting visibility are terrain; climatic conditions, such as fog and haze; smoke; dust produced in firing; and definition of the aiming point at the range at which it is to be used. The effect of terrain can best be determined by on-the-spot reconnaissance. Naturally, an aiming point concealed by a hill or by trees would be of no value. In many cases, due to climatic conditions, fog can be expected to obscure an otherwise desirable aiming point. In such situations, firing data might be available from radar sets or from nearby batteries not blanketed by fog. Therefore, additional aiming points should be established at such distances and directions that the error will be as small as possible even though it exceeds the permissible pointing error mentioned in the following paragraphs. Consideration should be given to the possibility of illumination of the aiming point during the hours of darkness. The definition of the aiming point must also be considered. A good aiming point should have a clearly defined shape, should be free from confusing lines or figures, and should stand out sharply against the background in order that the gun pointer may locate it quickly.

b. Permissible pointing error. Generally speaking, the accuracy desired in pointing seacoast guns should be such that the angular error due to sight displacement does not exceed 0.03° and that the lateral error resulting therefrom does not exceed 10 yards. For any particular situation, the minimum range to the aiming point which will not cause the permissible pointing error to be exceeded can be determined by substituting the

permissible angular error in the equation shown in paragraph 62 and solving for the range.

64. ALTERNATE AIMING POINTS. Since there is always a possibility that an aiming point will be destroyed by enemy action, alternate aiming points should be provided and provision made for changing from one aiming point to another during an action. A method for doing this is given in FM 4-15.

65. PROCEDURES FOR AIMING POINT SELECTION. It has been found that certain procedures may, if followed, make unnecessary a great deal of computation on the part of the battery officer. The following procedures for locating aiming points for the mobile guns will be of value if properly applied.

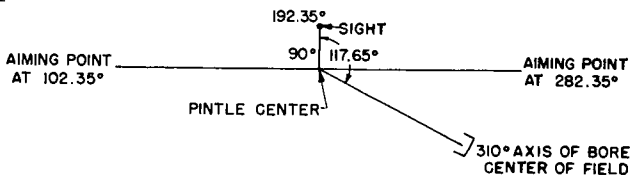

Figure 22. Illustration for paragraph 65a.

a. Aiming point selection and orientation (155-mm gun G.P.F. with M8 telescope; 60° traverse, 24-inch displacement of sight from pintle center).

(1) The aiming point may be placed as close as 100 yards if the two following ideal conditions exist:

(a) The direction to the aiming point is perpendicular to the line pintle center-sight when the gun is in the middle of its traverse. (See fig. 22.)

(b) The orienting position of the gun is between 7° and 11° from either limit of traverse.

(2) The aiming point should not be closer than 180 yards if the two following conditions exist:

(a) The azimuth of the aiming point is as described in (1) (a) above.

(b) The orienting position of the gun is other than specified in (1) (b) above.

(3) If the condition in (1) (a) above regarding the ideal azimuth of the aiming point is not to be observed (that is, if it is proposed to use a structure or natural object as an aiming point which is not at right angles to the line pintle center-sight), the following procedure is recommended:

(a) Set up an M1910A1 azimuth instrument at or very close to the proposed aiming point.

(b) With the gun at its orienting position, center the 300 or normal line of the splash scale on the gun sight. A pencil held on the gun sight and in its vertical axis may aid in sighting.

(c) Have the gun traversed to its limits and observe the maximum lateral movement of the sight.

(d) Read the amount of movement directly off the splash scale without traversing the azimuth instrument. If the lateral movement exceeds the limit of 0.03° , the aiming point is too close. Try another position.

(4) *Example (ideal conditions)*. A certain gun has a traverse from 280° to 340° . The center of the field of fire is 310° . Figure 22 shows the ideal direction for the aiming point to be either 102.35° or 282.35° . The rearward direction is probably better in that an aiming point located to the rear is less likely to be obscured by dust. The most favorable azimuths at which to orient the gun would be 287° to 291° or 329° to 333° .

b. Aiming point selection (any gun with a traverse of 360°). For a gun with a traverse of 360° , the rules for selecting aiming points are distinctly different from guns with a limited traverse. For example, the following rules will aid the officer of an 8-inch railway battery:

(1) The gun may be oriented at any convenient azimuth.

(2) The aiming point should be in prolongation of the line pintle center-sight when the gun is in its orienting position.

(3) If condition in (2) above is fulfilled, the minimum distance to the aiming point is equal to the actual sight displacement of the carriage (in yards) multiplied by 1,900. The effective sight displacement can be any value between zero and the actual displacement. If the maximum error is taken as 0.03° and the above values substituted in the second formula in paragraph 62a (4), this formula becomes:

$$0.03 = \frac{(\text{actual displacement} - 0) \times 57}{d}$$

and
$$d = \frac{57}{0.03} (\text{actual displacement})$$
$$= 1,900 \times \text{actual displacement}$$

(4) If condition in (2) above is not fulfilled, proceed as for the 155-mm gun (measure the maximum sight displacement error and select the proper aiming point).

c. Problems relating to the Panama mount for 155-mm gun G.P.F. When the 155-mm gun G.P.F. is mounted on the Panama mount to increase its traverse to 360° , the actual sight displacement is not the distance from the pintle center of the gun to the sight but the distance from the center of rotation of the carriage to the sight. The center of rotation of the carriage is considered to be 23 inches ahead of the pintle center. Thus the actual sight displacement is a variable, depending upon the position of the cradle with respect to the carriage. The sight displacement may reach a maximum of 45 inches. Two approaches may be made to the problem:

(1) If it is allowable to reorient the sight each time the trails are moved, the problem resolves itself into a series of 155-mm gun problems, each

of which can be solved in the ordinary manner. (A new problem arises each time the trails are moved.)

(2) If, to save time, the sight is not reoriented after the movement of the trails, then the aiming point, under the least favorable conditions of orienting azimuth and aiming point azimuth, must be 4,800 yards away. If care is taken in choosing the most favorable aiming point azimuth, this distance may be reduced by one-half or 2,400 yards. In many cases these distances are impracticable. Perhaps the most practical solution is the use of an aiming rule. This rule should be long enough to allow for any possible position of the sight and so set up that no interference with the line of sight can be expected from either gun tube or gun personnel. (See FM 4-15 for description and use of aiming rule.)

CHAPTER 6

ERRORS, PROBABILITY, AND DISPERSION

Section I. GENERAL

66. GENERAL. Individual shots in artillery fire rarely fall on the spot calculated, even though great skill and care are used in firing the guns. An artilleryman with a knowledge of the factors causing this deviation from the intended point of impact can reduce the deviation and increase the effectiveness of fire. To explain the fall of shot and the chances of a shot hitting the intended point, the last part of this chapter deals with probability and dispersion.

Section II. DEFINITIONS OF ERRORS

67. DEVIATIONS. a. The deviation of a shot is the distance by which a shot misses the target. The absolute deviation is this distance measured along a straight line from the point of impact to the target (see fig. 23). The absolute deviation is seldom used as such; it is generally broken into its two components, the range deviation and the lateral deviation. The range deviation is measured along a line parallel to the gun-target line; the lateral deviation is measured at right angles to the gun-target line.

b. The center of impact, also called the mean point of impact, is the mean or average position of the several points of impact of a series of shots.

The range (lateral) deviation of the center of impact is the algebraic mean of the range (lateral) deviations of the separate shots.

c. It is convenient to refer deviations and the center of impact to a set of rectangular axes in the horizontal plane containing the target. The intersection of the axes is located at the target, the Y-axis being placed along the gun-target line and the X-axis perpendicular to it. The range deviation of a point of impact is then the Y-coordinate of that point, and the lateral deviation is its X-coordinate. The Y-coordinate of the center of impact is the algebraic mean of all the Y-coordinates of the points of impact. The X-coordinate of the center of impact is the algebraic mean of the several X-coordinates. Deviations that are over or to the right are considered *plus*; those that are short or to the left are considered *minus*.

d. For example, four shots are fired with the same pointing and fall as indicated in the table following. These points of impact are plotted in figure 24.

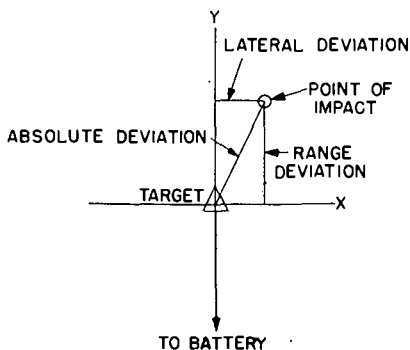

Figure 23. Deviations.

Shot No.	Range deviation (yards)	Lateral deviation (yards)
1	Over 180	Left 42
2	Short 60	Left 18
3	Short 45	Right 24
4	Over 73	Left 22

The Y-coordinate of the center of impact is $(180 - 60 - 45 + 73)/4 = +148/4 = +37$ yards. The X-coordinate of the center of impact is $(-42 - 18 + 24 - 22)/4 = -58/4 = -14.5$ yards. It is therefore 37 yards beyond the target and 14.5 yards to the left.

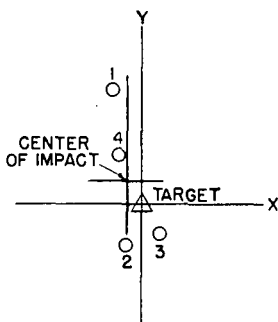

Figure 24. Center of impact.

e. The center of impact must be distinguished from the center of dispersion. The center of impact is the mean point of impact of shots that have already fallen; the center of dispersion is a theoretical point, the center of a group that would have been formed if an infinitely large number of shots had been fired. Obviously, an artilleryman can never locate the center of dispersion and, for all practical purposes in any operation or discussion,

he must consider the center of impact only, treating it as though it were actually the center of dispersion.

68. ERROR. An error is the difference between the observed or calculated value and the true value of a quantity. Different kinds of errors have been given special names. A knowledge of these errors is necessary.

a. Personnel errors. These are small errors made by the personnel in the operation of fire-control instruments. Some small, unavoidable personnel errors can be reduced to a minimum by training. Large personnel errors, generally called mistakes, can be avoided by proper care and training. Personnel errors may be either systematic or accidental.

b. Systematic errors. Systematic errors are constant errors affecting all readings in a series alike. In artillery firing, the divergence of the center of impact of a large number of shots from the target is caused by a systematic error (such as an error in the assumed muzzle velocity). In the study of precision measurements, the divergence of the average of several readings from the true value of the quantity measured is called a systematic error (see d below).

c. Accidental error. These are unpredictable variations from normal that cannot be entirely eliminated and are irregular in their effect on consecutive trials. In a series of trials, it is found that the accidental errors are more likely to be small than large, just as likely to be plus as minus, and by experiment a maximum limit can be determined which no error should exceed. In gunnery, the divergence of the individual impacts from the center of impact is the result of accidental errors.

d. Example. The difference between systematic and accidental errors can be shown by taking an

example of the simple measurement of the distance between two points. Two men using a 100-foot tape are to measure the distance between two points approximately 90 feet apart. Their tape had been broken and, when repaired, had been made .050 of a foot too long between the 50 and 51 marks. Unaware of the error in the tape, the men measure the distance between the points three times with the following results: 91.741, 91.736, 91.728 feet. They take the mean of these three measurements, 91.735 feet, as the measurement of the length of the line. It is apparent that all the measurements are in error by the amount of the error in the tape, .050 of a foot. Therefore this error is a *systematic* error, and the true measurement should be considered as 91.785 feet. The *accidental* error in each of these measurements is the difference between each measurement and the mean. In this case, the first measurement was .006 of a foot more than the mean, the second measurement .001 of a foot more, and the third .007 less. Therefore the accidental error in the first measurement is $+0.006$ of a foot, the second measurement $+0.001$ of a foot, and the last -0.007 . In any type of work involving precise measurement, errors are to be expected due to the limitations of the equipment used in making the measurements. The effect of the systematic error in this distance could have been eliminated by a careful examination of the tape. The amount of the accidental errors could have been reduced by careful training of the men making the measurement. However, the complete elimination of accidental errors is never accomplished.

e. Probable error. The probable error is that accidental error which is as likely as not to be exceeded on any one trial. In gunnery, the probable error is that distance which is as likely as not to be exceeded by the deviation of the point of impact of any one shot from the center of impact of

a large number of shots. In the ideal dispersion group, one-half of the shots lies more than one probable error and the other half lies less than one probable error from the center of impact.

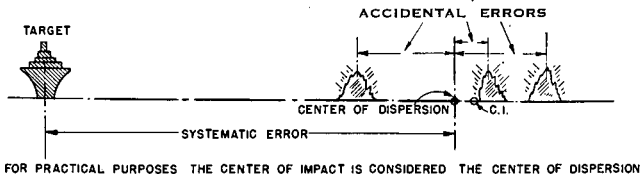

Figure 25. Systematic and accidental errors.

Since those lying more than one probable error from the center of impact are much more scattered than those lying closer, the average error, or mean error, is greater than the probable error. In the so-called "normal" distribution, the ratio between the two is fixed, and the probable error is equal to the mean error multiplied by 0.845.

f. Armament error. This is a special type of accidental error. It is the divergence, stripped of all measurable personnel errors and adjustment corrections, of a shot from the center of impact of a series of shots similarly stripped.

g. Developed armament probable error. In the analysis of a firing, the mean armament error (arithmetical mean of the stripped deviation; that is, disregarding all algebraic signs) is multiplied by 0.845 to obtain what is known as the developed armament probable error (DAPE). For example, take a series of four shots whose range deviations are +180, -60, -45, and +73 yards respectively. The center of impact is found to lie 37 yards beyond the target (systematic error). The accidental errors of these shots are then as follows:

Shot	Range accidental error
1	+180 -37 = +143 yards
2	-60 -37 = -97 yards
3	-45 -37 = -82 yards
4	+73 -37 = +36 yards

If it is assumed that all personnel errors and adjustment corrections have been stripped out, then these are also the armament errors of the shots. The mean armament error (arithmetical mean) is then $(143 + 97 + 82 + 36)/4 = 358/4 = 89.5$ yards. The developed armament probable error is equal to $89.5 \times 0.845 = 75.6$ yards.

Section III. CAUSES OF ERRORS

69. GENERAL. As a great number of factors affects artillery fire, the elimination of all errors is impossible. In the calculation of firing data, errors are introduced by the inaccuracies of instruments, and by mistakes, ignorance, and carelessness of personnel. These errors may be classified as both accidental and systematic errors and are reduced to a minimum by training and care. Other sources of error fall into one of three general groups: conditions in the carriage, conditions in the bore, and conditions during flight.

70. CONDITIONS IN THE CARRIAGE. Variations in the accuracy of setting and nonuniformity of reaction to firing stresses cause accidental errors. Variations in accuracy of setting may be caused by physical limitations in the accuracy of setting scales and by play in the gearing. Non-uniformity of reaction to firing stress may be due,

in mobile guns, to differences in footing of spades and outriggers. The factors causing such accidental errors cannot be eliminated entirely but they can be reduced by the following measures: the final motion in setting the gun should be made in the same direction each time; materiel should be maintained in excellent condition; and, in the case of mobile guns, the spades and outriggers should be carefully and solidly emplaced.

71. CONDITIONS IN THE BORE. Variations in conditions inside the bore while firing create accidental and systematic errors of great magnitude. Variations in temperature, composition, and ignition of powder, weight of projectile, erosion, and density of loading have a direct effect on muzzle velocity and consequently on the range.

a. As discussed in chapter 2 (par. 20c (2)), the temperature of the powder charge as the gun is fired determines to a great extent the muzzle velocity to be expected. If it is different from the temperature assumed in the calculation of firing data, a *systematic* error will result. Variation in the temperature of individual powder charges may be caused by differences in the length of time the powder charges remain out of the powder magazine. Also slight variations in powder temperature may be caused by differences in the time the charges remain in the bore before firing, and by differences in the temperature of the bore. Such variations cause small changes in the developed muzzle velocity and consequent *accidental* errors, the size of which may be reduced by uniform handling of powder charges.

b. The composition of the powder is subject to change during storage due to the change in moisture content and the loss of volatiles. This will produce a change in muzzle velocity which will cause a systematic error. The powder may, after

a long period of time, begin to break down, and as a result excessive pressures will be developed when it is used. The Ordnance Department usually makes surveillance tests each year on powder lots stored in the field. The test is made by opening several powder containers at random and inserting in each container a piece of blue litmus paper. It is left in the container about 10 days to see if the litmus changes color. If so, the powder is breaking down and is accordingly withdrawn from service. If the litmus does not change color, the containers are carefully resealed. The battery commander can help to prevent powder from deteriorating by seeing that powder containers are handled carefully to prevent breakage of the airtight seal. If there is any doubt about a lot of powder, it should be tested. Variation in muzzle velocity can be expected between different lots of powder. Therefore, in any particular firing, it is advisable to use powder from the same lot and to store powder from the same lot under similar conditions. Wherever possible, the muzzle velocity expected from each powder lot should be determined.

c. Nonuniform ignition of the propelling charge causes variations in muzzle velocity and consequent accidental errors. Igniting charges are fastened to the powder charges to aid uniform ignition. To reduce the size of accidental errors, the battery commander should make certain that the igniters are properly fastened to the powder charge. In addition, the powder charge should be pushed into the powder chamber by the breechblock during the final stage of its forward motion. This is to insure that the igniter pad will be against the mushroom head to obtain the full effect of the primer flame.

d. The weight of the projectile, as discussed in chapter 2 (par. 20b), has an effect on the muzzle velocity and on the ballistic coefficient of the

projectile. These effects are contradictory in their influence on the range obtained, and their resultant magnitude changes with different ranges. Variations in the weight may cause systematic errors and accidental errors. If the weight of the projectile assumed in the calculation of firing data differs from the mean weight of the projectiles fired, a *systematic* error is introduced. Variations in weight of individual projectiles contribute *accidental* errors. To reduce these errors to a minimum, projectiles should be segregated into groups by lot and weight, and firings should be executed with projectiles from the same group. Correction is then made in the firing data for the variation from standard weight. Unequal ballistic coefficients of different lots may cause a large systematic error between lots.

e. Erosion is the wearing of the interior of a gun tube due to the action of the projectile, metal fouling, powder grains, and powder gases. It causes a loss of muzzle velocity and results mostly in a systematic error. The amount of erosion in a gun is determined by star gaging. In this test, the diameter of the bore between lands and also between grooves is measured at various intervals throughout the length of the bore. The advance of the forcing cone is also measured. Ordinarily a new gun may be expected to fire a definite number of rounds before its accuracy is impaired. This number of rounds is known as the estimated accuracy life of the gun. In certain cases, the gun may be in good condition at the end of its estimated accuracy life, making it possible to continue using the gun. The gun is tested after 10 percent and 90 percent of its estimated accuracy life, and after 90 percent at each 10 percent thereafter while continued in service. For example, a certain gun might have an estimated accuracy life of 2,000 rounds. It should therefore be tested after 200 rounds have been fired and after 1,800 rounds

have been fired. The results of the last test will show whether the gun should be continued in service beyond its estimated accuracy life. If continued in service, tests should be made after each 200 rounds until the gun is found unfit for service. The battery commander can keep the erosion of his guns approximately the same by keeping the number of rounds fired from each gun the same. Where more than one size of powder charge is used, allowance must be made for the fact that the greater powder charge will cause more erosion than the smaller. For example, in the 155-mm G.P.F. the supercharge will cause four times as much erosion as the normal charge. In this case, if the supercharge round is taken as the unit round, the normal charge round can be considered as one-fourth of a round when balancing erosion. The data on the number of rounds fired, star-gaging tests, and equivalent rounds are kept in the emplacement or gun book. From the results of the star-gaging tests, the battery commander knows which guns are eroded most. However, it is still not possible to keep all guns eroded exactly the same. Since this is the case, the unequal loss of muzzle velocity may make it necessary to apply corrections to individual guns to make all the guns shoot together.

f. One of the factors on which the developed powder pressure, and therefore the muzzle velocity, depends is the density of loading. Density of loading is the ratio of the weight of the powder charge to the weight of the volume of distilled water at 39.3° F. that would be required to fill the powder chamber. Obviously two elements that will cause variations in the density of loading are nonuniformity of weight of powder charges and differences in the seating of the projectiles (their positions in the bore just before firing). Either of these two elements will cause changes in muzzle velocity and corresponding accidental errors.

Hence, it is necessary to seat the projectiles as uniformly as possible. This is best accomplished by requiring the ramming detail to always use a uniform force in ramming. This force must also be sufficient to seat the projectile properly in order to prevent the projectile from slipping back onto the powder charge when the gun is elevated. If the projectile were to slip back into the powder chamber, the volume of the powder chamber would be reduced and the density of loading would be increased. The resultant powder pressure might become so high as to damage the gun.

72. CONDITIONS DURING FLIGHT. During the time the projectile is in the air, it is affected by many conditions that may cause errors. Some of these are the ballistic properties of the projectile, the angle at which it leaves the bore of the gun, and the atmospheric conditions it encounters. Of these, the last is probably of most importance. Rarely, if ever, will two shots from the same gun pass through identical conditions of wind in their trajectories. Therefore, accidental errors take place. Again, it is quite likely that differences exist between the actual effective conditions at the time of a firing and those described by the meteorological message. This situation presents a systematic error in the firing data. Since it is impossible to determine the magnitude of these errors, the only solution is to use meteorological data that are as recent as possible.

73. SEGREGATION OF ERRORS BY ANALYSIS. In preparation for firing, a study should be made to determine sources of errors and the necessary steps taken to reduce the errors to a minimum. An analysis of drill of the range section should be made to determine errors made in transmission of data between operators of instruments and also errors made in operation of instruments. (See

TM 4-235.) Errors caused by conditions in the carriage, conditions in the bore, and conditions during flight should be reduced as much as possible. Those errors not eliminated will appear during actual firing and, if proper records are kept, an analysis of the results can be made. In analyzing a firing (see TM 4-235), personnel errors, accidental errors, and systematic errors are determined. The accidental errors stripped of personnel errors and adjustment corrections are armament errors. The mean of the armament errors multiplied by 0.845 is the developed armament probable error of the battery. The systematic error of the firing stripped of all known errors is considered to be caused by one factor, an erroneous assumption of muzzle velocity. The range error is converted into a muzzle velocity effect and this is applied as a correction to the assumed muzzle velocity with which the firing was conducted. In order to determine the muzzle velocity developed for each gun, the shots must be staggered and the systematic error found for each gun. The velocity thus determined is that one which theoretically would have brought the center of impact on the target if it had been used in the calculation of firing data. An average of determined DAPE's and a weighted average of developed muzzle velocities should be used in future firings.

Section IV. MATHEMATICS OF PROBABILITY

74. GENERAL. Probability is the branch of mathematics that deals with the likelihood of the occurrence of an event concerning which information is not complete. It may deal with the occurrence or nonoccurrence of an event, past, present, or future; and with the truth or falsity of a statement or a conclusion. It furnishes a guide to sound reasoning when chance takes the place of certainty.

75. NUMBERS USED. When the occurrence of an event is certain, the probability of the event is represented by 1 (unity); when the occurrence is impossible, the probability is represented by 0 (zero); and when the occurrence is neither certain nor impossible, the probability is represented by a number between these limits. If an event is as likely as not to occur, its probability is one-half. As the likelihood increases, the probability approaches unity. As the likelihood decreases, the probability approaches zero. If the odds in favor of an event are three to one, its chances are three out of four, or its probability is three-fourths. If an event has one chance in ten of happening, its probability is one-tenth.

76. RULE FOR ADDITION. a. Two events are mutually exclusive when the occurrence of the first precludes the occurrence of the second, and the occurrence of the second precludes the occurrence of the first. If the probability of the first event happening is P and the probability of the second event happening is Q , and the two events are mutually exclusive, then the probability of either the first or the second happening is $P + Q$. This is the rule for the addition of probabilities and may be extended to include any number of mutually exclusive events or conclusions.

b. Example. (1) The probability that a shot will hit the side of a ship is 0.08, and the probability that it will hit the deck is 0.13. *What is the probability that it will hit either the side or the deck?*

(2) *Solution.* A shot cannot hit both the side and the deck, so the two events are mutually exclusive. The rule for addition may therefore be applied, and the required probability is the sum of 0.08 and $0.13 = 0.21$.

77. RULE FOR MULTIPLICATION. a. Suppose the occurrence of event A consists of the joint oc-

currence of event *B* and event *C*. If the occurrence or nonoccurrence of *B* has no effect upon the occurrence or nonoccurrence of *C*, then the probability of *A* is equal to the probability of *B* times the probability of *C*. This is the rule for the multiplication of probabilities and may be extended to include any number of contributing events.

b. Example. The probability that a shot will be a hit in range is 0.26 and that it will be a hit in direction is 0.68. Then the probability that the shot will be a hit in both range and direction is equal to $0.26 \times 0.68 = 0.1768$ or 18 percent.

Section V. DISPERSION

78. GENERAL. **a.** If several shots are fired from a gun set each time at the same azimuth and elevation, these shots will not fall at the same spot. They will be scattered, both in range and in direction, by unavoidable changes in pointing, muzzle velocity, wind, and all the other conditions that determine the shape of the trajectory. This scattering is called dispersion.

b. The area over which shots are scattered by dispersion is called the dispersion zone. The distribution of shots within the dispersion zone is a matter of importance in drawing up rules for adjusting fire, estimating fire effect, and calculating ammunition requirements.

c. If a great many shots are fired with the same pointing, it is probable that a plot of the points of impact will show the same general characteristics as the group plotted in figure 26. The concentration is densest near the center of the group and becomes gradually less toward the outer edges. There are approximately as many shots short of the center of the group as there are beyond it, and as many to the right as to the left.

Range dispersion is almost always greater than lateral dispersion, so that the longer axis of the group is along the gun-target line.

d. The smallest rectangle that can be constructed (see fig. 26) to include all or practically all of the shots is called the 100-percent rectangle. If the 100-percent rectangle is divided into eight equal parts by lines drawn perpendicular to the line of fire, as in figure 27, the percentage of shots to be expected in each part is that indicated in the figure. This figure is called a dispersion ladder. The dispersion ladder may be expanded or contracted to fit various conditions of dispersion, but it always consists of eight equal divisions and the percentages do not change. In figure 27, the dispersion ladder has been constructed to show range dispersion, and may be called the dispersion ladder for range. Figure 28 shows the construction of a dispersion ladder for direction, the dividing lines being drawn parallel to the line of fire.

e. The two strips lying nearest the center of the dispersion ladder are expected to contain one-half of all shots fired. Together they make up the 50-percent zone. There is a 50-percent zone for range and a 50-percent zone for direction. In some cases, it is necessary to specify which of the two is intended.

f. The distance equal to one-half the length (or width) of the 50-percent zone is the probable error. The range probable error is one-eighth of the length, and the lateral probable error is one-eighth of the width of the 100-percent rectangle.

g. When the dispersion ladder for range is superimposed upon that for direction, the result is the assemblage of small rectangles, shown in figure 29, called the dispersion diagram. The percentage of shots to be expected in any particular small rectangle is derived from the percentages expected in the two strips, range and lateral,

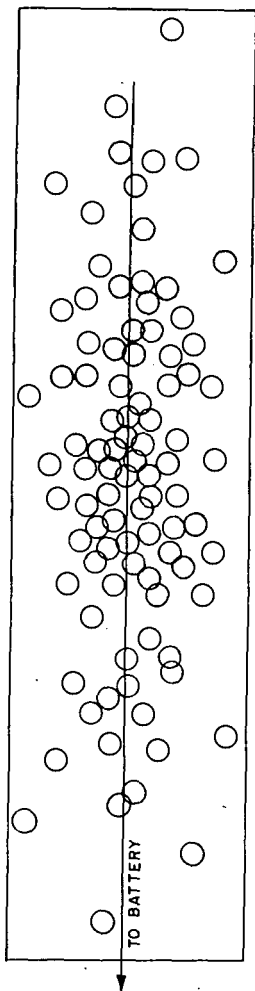

Figure 26. The 100-percent rectangle.

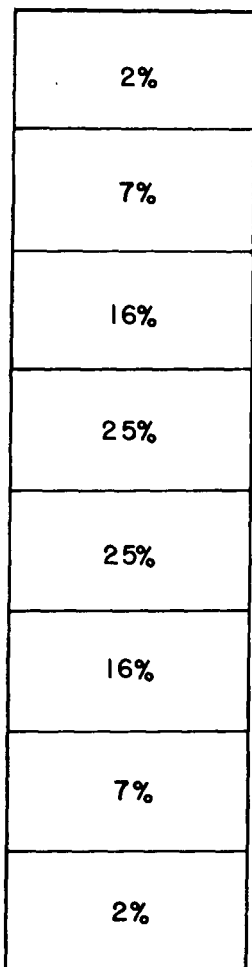

Figure 27. Dispersion ladder for range.

2%
7%
16%
25%
25%
16%
7%
2%

Figure 28. Dispersion ladder for direction.

2% x 2% = .04%	7% x 2% = .14%	16% x 2% = .32%	25% x 2% = .50%	25% x 2% = .50%	16% x 2% = .32%	7% x 2% = .14%	2% x 2% = .04%
2% x 7% = .14%	7% x 7% = .49%	16% x 7% = 1.12%	25% x 7% = 1.75%	25% x 7% = 1.75%	16% x 7% = 1.12%	7% x 7% = .49%	2% x 7% = .14%
2% x 16% = .32%	7% x 16% = 1.12%	16% x 16% = 2.56%	25% x 16% = 4.00%	25% x 16% = 4.00%	16% x 16% = 2.56%	7% x 16% = 1.12%	2% x 16% = .32%
2% x 25% = .50%	7% x 25% = 1.75%	16% x 25% = 4.00%	25% x 25% = 6.25%	25% x 25% = 6.25%	16% x 25% = 4.00%	7% x 25% = 1.75%	2% x 25% = .50%
2% x 25% = .50%	7% x 25% = 1.75%	16% x 25% = 4.00%	25% x 25% = 6.25%	25% x 25% = 6.25%	16% x 25% = 4.00%	7% x 25% = 1.75%	2% x 25% = .50%
2% x 16% = .32%	7% x 16% = 1.12%	16% x 16% = 2.56%	25% x 16% = 4.00%	25% x 16% = 4.00%	16% x 16% = 2.56%	7% x 16% = 1.12%	2% x 16% = .32%
2% x 7% = .14%	7% x 7% = .49%	16% x 7% = 1.12%	25% x 7% = 1.75%	25% x 7% = 1.75%	16% x 7% = 1.12%	7% x 7% = .49%	2% x 7% = .14%
2% x 2% = .04%	7% x 2% = .14%	16% x 2% = .32%	25% x 2% = .50%	25% x 2% = .50%	16% x 2% = .32%	7% x 2% = .14%	2% x 2% = .04%

Figure 29. Dispersion diagram.

whose intersection forms the rectangle. For example, a rectangle lying in one of the 7-percent strips of the dispersion ladder for range and also in one of the 16-percent strips of the dispersion ladder for direction would be expected to include 16 percent of 7 percent of the shots, or about 1 percent (rule of multiplication $0.16 \times 0.07 = 0.0112$).

h. When a shot is erratic or wild, it is disregarded in the calculation of the center of impact, probable error, adjustment correction, or any similar data. The rules for determining whether or not a shot is wild are based on the general proposition that if it falls outside the 100-percent rectangle, or more than four developed armament probable errors from the center of dispersion, it should be disregarded.

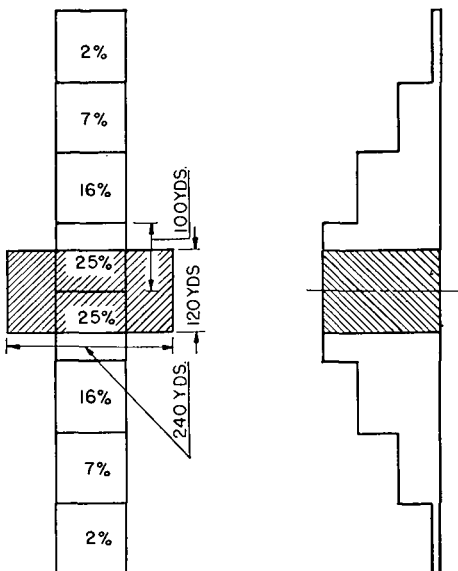

Figure 30. Center of dispersion on center of target.

79. USE OF DISPERSION LADDER IN COMPUTATION OF PROBABILITY OF HITTING.

a. Center of dispersion on center of target. (1)

Example. The center of dispersion is placed on the center of a target as shown in figure 30. The dimension of this target in the direction of the gun-target line is 120 yards, and its lateral dimension is so great that no shots will be expected to miss it in direction. The probable error in range is 100 yards. Compute the probability of hitting with a single shot.

(2) *Solution.* The 50-percent zone is twice the probable error or 200 yards. The target occupies 120/200, or 60 percent, of the 50-percent zone. It will therefore be expected to contain 60 percent of 50 percent of the shots, or 30 percent. The probability of hitting is then 30 percent.

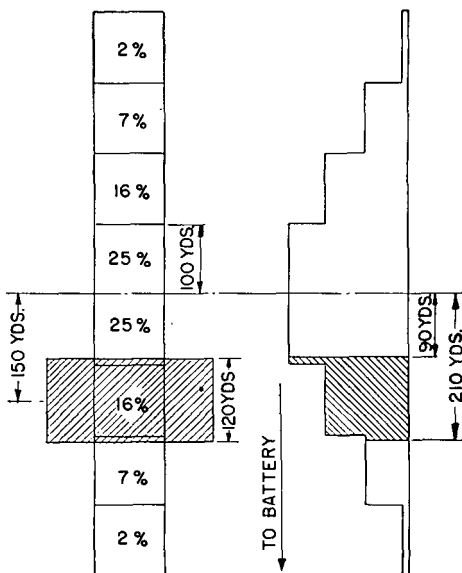

Figure 31. Center of dispersion not on center of target.

b. Center of dispersion not on center of target.

(1) *Example.* The conditions are the same as in the example under *a* above except that the center of dispersion is 150 yards over the center of the target. The situation will then be shown in figure 31. Find the probability of hitting with a single shot.

(2) *Solution.* The two edges of the target will be 90 yards and 210 yards respectively from the center of dispersion. The target occupies 10/100 of the 25-percent zone, 100/100 of the 16-percent zone, and 10/100 of the 7-percent zone. The probability of hitting then equals $0.025 + 0.160 + 0.007 = 0.192$ or 19 percent.

Section VI. CURVE OF ACCIDENTAL ERRORS

80. GENERAL. a. For most practical purposes, the rough ideas of dispersion conveyed by the dispersion ladder are good enough, but calculations are made easier and more refined by the use of the representative curve of accidental errors. (See fig. 32.) This curve is plotted with X-coordinates, representing size of errors, and Y-coordinates, the corresponding frequency of occurrence. To show the relation between the curve and the ladder, a part of the horizontal axis has been divided into eight equal parts, and at each point of division a perpendicular has been erected. This divides

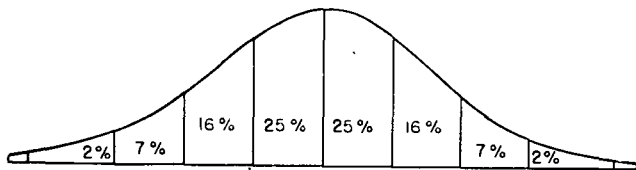

Figure 32. Curve of accidental errors.

the major part of the area included between the curve and the axis into parts whose areas are very nearly proportional to the numbers 2, 7, 16, 25, etc., of the dispersion ladder.

b. The division of the area included between the curve and the horizontal axis may be carried further. The whole of this area is made equal to unity, and then the part of the area included between any two perpendiculars is equal to the probability that a shot will fall between the two points in the field of fire represented by the two points at which the perpendiculars are erected. To determine the area under the curve and included between two perpendiculars and the axis, table II A (app. VI) is used.

c. When two perpendiculars are erected at equal distances from the center of dispersion, as at *A* and *B* in figure 33, the area included between them will depend upon the ratio of the distance *OB* to the distance *OP* (the probable error), or, what is the same thing, the ratio of the distance *AB* to the distance *P'P* (the 50-percent zone). When this ratio is fixed, the area is fully determined. This

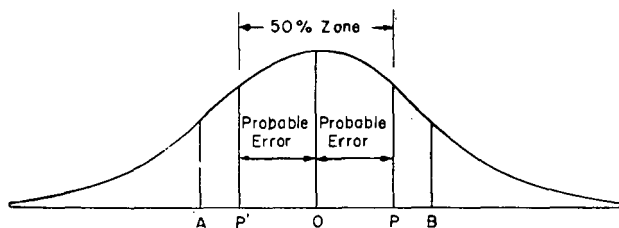

Figure 33. The factor.

ratio is called the factor. In table II A (app. VI), values of the area are listed under the heading, "Probability," opposite the corresponding values of the factor. In table II B (app. VI), values of the factor, or ratio, are listed opposite corresponding

values of the probability or area. There is no essential difference between the two tables; the two arrangements are for greater convenience in making interpolations.

81. USE OF CURVE IN COMPUTATION OF PROBABILITY OF HITTING.

a. Center of dispersion on center of target. (1) *Example.* The center of dispersion is placed on the center of a target as shown in figure 30. The dimension of this target in the direction of the gun-target line is 120 yards, and its lateral dimension is so great that no shots will be expected to miss it in direction. The probable error in range is 100 yards. *Compute the probability of hitting with a single shot.* Use table II A (app. VI) and compare results with those in paragraph 79a.

(2) *Solution.* The factor is equal to $120/200$ (or $60/100$) = 0.60. According to the table, the probability corresponding to this factor is 0.314 or 31.4 percent.

(3) *Comparison of results.* The two results do not check exactly. The use of the probability table is equivalent to finding the area under a part of a smooth curve, as in the upper part of figure 34, while the use of the dispersion ladder corresponds to finding the area under a broken line as in the lower part of figure 34.

b. Center of dispersion not on center of target.

(1) When it is required to find the probability of hitting between two points which are not symmetrical with respect to the center of dispersion, as between the points *C* and *D* in figure 35, it will be necessary to use the table twice. The area of the shaded portion *ABCD* is required. The ratio of the distance *CO* to the probable error will give, through the use of the table, the area of the figure *ABEFHC*. The ratio of the distance *DO* to the probable error will give, by the table, the area of *BEGD*. If the smaller area is subtracted from

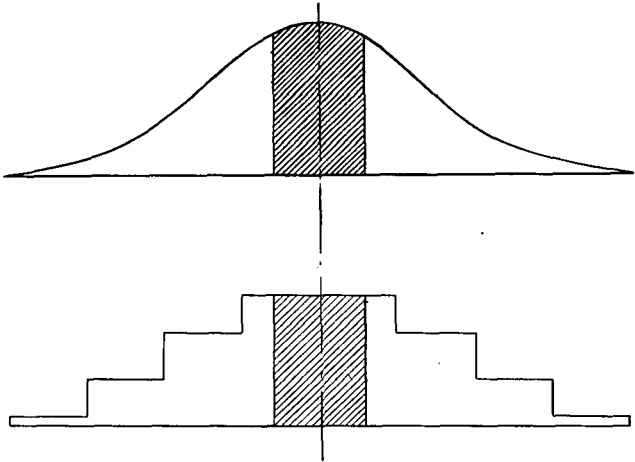

Figure 34. Dispersion ladder and curve of accidental errors.

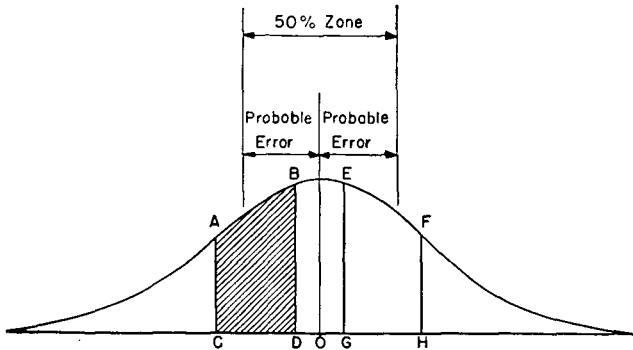

Figure 35. Center of dispersion off the target.

the larger and the remainder divided by two, the result will be the required area which is equal to the required probability.

(2) *Example.* All conditions are the same as in the example under a above, except that the center of dispersion is 150 yards over the center of the target. The situation will then be as shown in figure 36. *Find the probability of hitting.*

(3) *Solution.* The two edges of the target will be 90 yards and 210 yards, respectively, from the center of dispersion. The first factor is: $F_1 = 210/100 = 2.10$. The corresponding probability is: $P_1 = 0.843$. The second factor is: $F_2 = 90/100 = 0.90$. The corresponding probability is: $P_2 = 0.456$. The probability of hitting is equal to: $P = \frac{1}{2}(P_1 - P_2) = \frac{1}{2}(0.843 - 0.456) = 0.193$ or 19.3 percent.

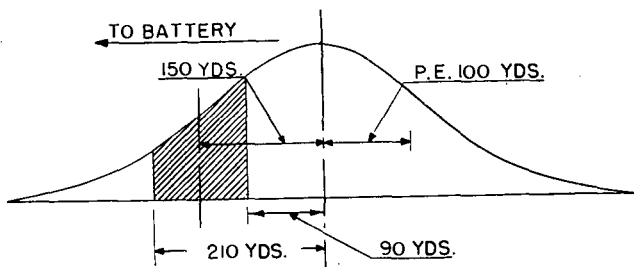

Figure 36. Illustration for example, paragraph 81b.

Section VII. DISTRIBUTION OF ERRORS

82. DISPERSION OF CENTERS OF IMPACT. a. If a large number of shots were fired in several short series, the centers of impact of the several series would be scattered in a manner similar to the scattering of the individual shots, but over a smaller area. The curve showing the dispersion

of centers of impact would be higher at the peak and its main part would cover less horizontal distance than the curve showing the dispersion of single shots. In figure 37 curve A shows the

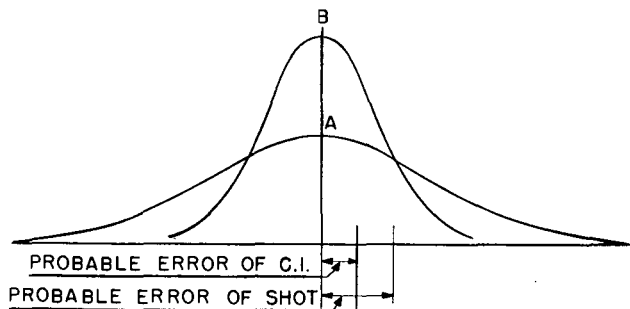

Figure 37. Distribution of centers of impact.

dispersion of separate points of impact and B shows the distribution of centers of impact of groups containing four shots each. It can be shown that the probable error of the center of impact of a group containing n shots is equal to the gun probable error divided by the square root of n , that is:

$$r_c = \frac{r_g}{\sqrt{n}}$$

where r_c is the probable error of the center of impact, r_g is the gun probable error, and n is the number of shots in the group. For example, the gun probable error is 72 yards. The probable error for the center of impact of a group of nine shots would then be: $72/\sqrt{9} = 72/3 = 24$ yards. This means that the center of impact of any one group of nine shots is as likely as not to be more than 24 yards from the center of dispersion.

b. The difference between the deviations of two successive shots is a quantity whose distribution may be determined if the distribution of shots is known or assumed. If the shots are normally distributed, that is, distributed according to the representative curve, the differences between successive deviations will also be normally distributed. If r_g denotes the gun probable error used to measure the dispersion of individual shots, then the probable error that measures the distribution of these differences will be equal to $r_g\sqrt{2}$. In the same way, differences between the range deviations of successive salvo centers of impact are normally distributed, the corresponding probable error being equal to the probable error of the salvo center multiplied by the square root of 2. For example, the distance between the centers of impact of two successive salvos in paragraph a above that is as likely as not to be exceeded is $24\sqrt{2} = 33.6$ yards.

83. COMPOUND ERRORS. a. A compound error is the result of two or more independent errors acting jointly. Thus, errors in position-finding instruments, personnel errors, and armament errors together determine the point of impact. Dispersion and the spotting error together determine the spotted deviation. If each contributing error is distributed normally, that is, according to a curve like that in figure 32; if the contributing errors are independent of one another; and if their values are added algebraically to determine the value of the resultant error; then the resultant error is normally distributed and its probable error is equal to the square root of the sum of the squares of the probable errors of the contributing errors.

b. The spotting error is not independent of the magnitude of the deviation, so that in compounding it with other errors the second of the conditions listed in the rule above is not fulfilled. It is

permissible to assume that it is independent simply for the purpose of making an approximate calculation. After the further assumption that spotting errors are normally distributed, the distribution of spotted points of impact as distinguished from actual points of impact may be calculated by this rule. The distribution of spotted points of impact is normal and its probable error is equal to:

$$r_s = \sqrt{r_g^2 + r_o^2}$$

In this equation, r_s is the probable error showing the distribution of the spotted points of impact, r_g is the probable error of gun dispersion, and r_o is the probable error of observation.

CHAPTER 7

CALIBRATION

Section I. GENERAL

84. DEFINITION. Calibration is the determining, from actual firings, of the necessary elevation and azimuth corrections to be applied to each gun to cause the guns of a battery to shoot together in both range and direction. When it has been observed that the centers of impact of shots from individual guns of a battery do not fall close together, a calibration correction is needed. Range calibration alone will be discussed in this chapter. Calibration corrections for direction are applied as angular corrections.

85. GENERAL. Calibration firings for newly constructed fixed batteries, or newly constituted mobile batteries, for which adequate records are not available, should be conducted as soon as possible after proof firing of the fixed batteries and emplacement of the mobile batteries. The occupation of new positions by mobile batteries is not considered in itself a reason for conducting calibration firings. If calibration data already are available for such batteries, the data should be applicable to one position as well as another.

86. THE PROBLEM IN BRIEF. It seems reasonable to ascribe the cause of unequal ranges attained by guns using the same ammunition prin-

cially to erosion and to treat the effects as differences in developed muzzle velocity. Although it is quite probable that the differences in range are not due entirely to differences in the developed muzzle velocity, the problem is considered as one of determining the velocity differences of the individual guns and applying corrections that will eliminate or at least reduce the effects.

87. THE SOLUTION IN BRIEF. Velocity differences are obtained from actual firings. The deviations of all shots are determined and are stripped of all known errors and corrections other than ballistic corrections. The center of impact for each gun is calculated. Any wild shot, as defined in TM 4-235, is disregarded. The deviation of the center of impact of each gun from the target is converted into muzzle velocity deviations from normal by reference to firing tables. One gun of the battery is then selected as standard with which to compare other guns. This gun is called the "reference piece" and will have no calibration correction. The other guns are called "test pieces." The gun selected as the reference piece should be the one which will cause the resulting corrections to be of a minimum number and magnitude.

88. WEIGHTING FACTORS. The centers of impact are subject to accidental variations. Therefore, the accuracy with which muzzle velocity is determined increases with the number of rounds fired or the number of determinations made. Target practices are a source of information and should not be disregarded. Since target practices are not fired as deliberately as calibration firings, the weight given to calibration firings should be up to four times greater than that given a target practice of an equal number of rounds. If the number of shots in each determination is not the same, the

mean of the several determinations should be a weighted mean; that is, all else being equal, the weight given to any determination should be proportional to the square root of the number of shots considered in that determination.

89. WARMING UP EFFECT. Some guns may be affected by a "warming up" or "clean gun" effect. In other words, the first one or two shots fired may be erratic where the remainder of the shots fall together. If such is the case, these shots must be disregarded and more rounds fired to have a sufficient number on which to base a correction. This may apply particularly with 3-inch, 90-mm, 6-inch, or 8-inch guns.

Section II. APPLICATION OF CORRECTIONS

90. MINIMUM CORRECTION. The question arises as to the minimum correction to make. In general, the recommendations of the minimum correction in adjustment of fire will apply. Fire will be effective if the centers of impacts of the guns are within one probable error of each other. In no case should a correction be based on a deviation of the center of impact of a gun from the reference piece of less than one-half probable error. Once a correction has been decided upon, it should be applied to the nearest foot-second muzzle velocity.

91. METHODS OF APPLICATION. After the velocity differences have been determined, they must be transformed into calibration corrections applicable to the guns. Several methods are given so that a battery commander can become familiar with the different procedures available for incorporating calibration corrections in the fire control system, and with the relative merits and

limitations of each procedure. One of the following methods may be employed:

- a. Range percentage correction.
- b. Percentage corrector tape with elevations for each platoon.
- c. Variable elevation correction.
- d. Constant elevation or range correction.

92. COMPARISON OF METHODS. a. **Range percentage correction.** The following tabulation and figure 38 show a tabular and graphical comparison between the effects in yards of range for an increase in muzzle velocity of +10 f/s, a correction of +0.5 percent of range, and a +2-mil correction in elevation. The tabulation shows the error (difference from +10 f/s muzzle velocity correction) in yards of range for the mil and the percentage range correction and, in the last column, the range probable error. The figure shows curves plotted one probable error on either side of the muzzle velocity correction curve.

*Comparison of range effects, based on
Firing Tables 155-W-1, projectile AP M112,
fuze BD M60, MV 2,360 f/s*

Range	Range effect				Error		PE
	+10 f/s		+2 mils	+0.5% Rn.	mils - f/s	% - f/s	
	(yds.)	(% Rn.)	(yds.)	(yds.)	(yds.)	(yds.)	(yds.)
2,000	14	.70	188	10	+174	-4	18
4,000	28	.70	152	20	+124	-8	20
6,000	40	.67	118	30	+78	-10	23
8,000	50	.63	90	40	+40	-10	26
10,000	58	.58	70	50	+12	-8	29
12,000	64	.53	56	60	-8	-4	33
14,000	70	.50	46	70	-24	0	37
16,000	77	.48	38	80	-39	+3	41
18,000	85	.47	28	90	-57	+5	46
19,000	89	.47	20	95	-69	+6	49

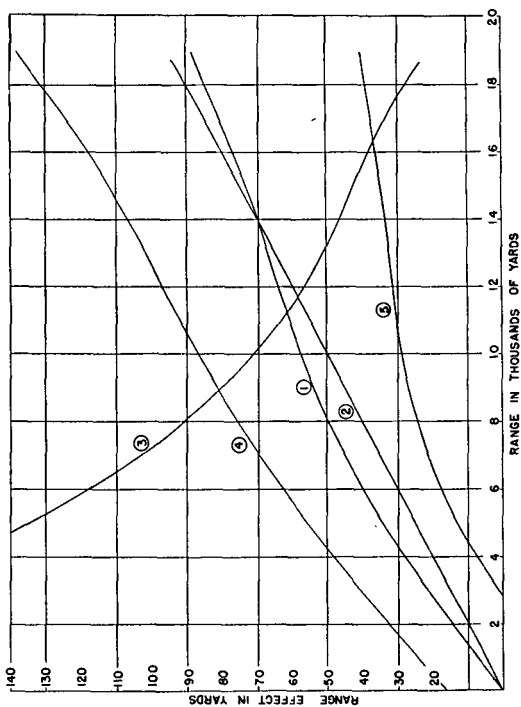

Figure 38. Comparison of range effects based on FT 155-W-1.

- (1) + 10 f/s muzzle velocity correction. (3) + 2 mils elevation correction.
 (2) + 0.5 percent range correction. (4) + 10 f/s correction plus 1 PE.
 (5) + 10 f/s correction minus 1 PE.

From the preceding comparison it may be seen that the correction as a percentage change of range will approximate the correction for a change in muzzle velocity. It will be necessary to use a percentage corrector for each individual gun, or some means of sending separate ranges to individual guns. When using two guns, a second "read" pointer may be used on the percentage corrector. This pointer is offset from the read pointer of the reference piece by the percentage range difference, and the range is read to the test piece. When using four guns, the problem becomes more complex. Applying the correction on the percentage corrector is practicable only when the four guns can be considered as two groups, in which case only two sets of firing data need be sent to the guns. However, sending two sets of firing data to the guns is not considered practical when the interpolator is used.

b. Percentage corrector tape with elevations for each platoon. Another method is to construct a special percentage corrector tape, with elevation scales for each gun, for use on the percentage corrector. The difference in elevation for the muzzle velocity difference is figured for each 100 yards. A tape is then constructed with the elevations for the "reference piece" and the "test piece" plotted opposite the logarithmic scale of ranges from minimum to maximum range. This procedure eliminates the multiplicity of pointers on the percentage corrector and gives true elevations to each gun. If subsequent firings indicate that new calibration corrections are justified, a new tape must be constructed. When using four guns, the problem becomes more complex. Applying the correction on the percentage corrector is practicable only when the four guns can be considered as two groups, in which case only two sets of firing data need be sent to the guns. However, sending two

sets of firing data to the guns is not considered practical when the interpolator is used.

c. Variable elevation correction. The muzzle velocity correction may be determined as an angle of elevation varying with the range, and it may be applied in one of several ways. On guns using the M5 data transmission system, a variable correction in mils of elevation could be taken from a chart and applied on the differential of the transmitting unit in the plotting room, but on guns having an angle of site adjustment on the sight, a variable correction could be applied to the angle of site. A more accurate method is to apply the corrections by means of an elevation conversion tape at each gun. The effect of the difference in muzzle velocity is converted into mils of elevation for every 100 yards of range. The correction in mils for the test piece is then applied to the standard elevation. A tape is constructed with normal elevations plotted on one line and corresponding corrected elevations plotted on the line above. One such tape is constructed for each of the test pieces. The elevation for the reference piece is sent from the plotting room to all guns. The elevation setter at the test piece sets the elevation on the normal scale under the index of the box and reads the corrected elevation for his gun on the scale above.

d. Flat elevation correction. The muzzle velocity correction may be converted into range differences at mean range and applied as a flat elevation correction; that is, by displacing the range disk or the elevation quadrant. This method will hold only within close proximity of the range chosen. When a target is engaged at different ranges, the error introduced will increase rapidly. (See fig. 38 for comparison.) This method is the least complicated, but it is not a satisfactory method of applying muzzle velocity corrections.

e. Gun data computer method. The ideal situation would be one in which the exact calibration would be automatically included by some device on the gun or in the gun data computing system. Such a system will be included in electrical gun data computers as a muzzle velocity difference dial.

f. Regrouping. When wide differences in muzzle velocity exist, mobile guns of the same caliber should be regrouped, within geographical limitations, on a basis of equally developed muzzle velocities.

Section III. CALIBRATION FIRE

93. PREPARATION FOR FIRE. In general, the preparation of a battery for calibration firing should be the same as that made before any other firing. The adjustment of range disks and quadrants should be given special attention and the pointing in elevation should be checked for every shot. Observation instruments should be carefully adjusted and oriented. Opportunity should be taken during calibration firing to check thoroughly the functioning of materiel and equipment. The ammunition used should be ballistically the same as the type comprising the major portion of the battle allowance of the firing battery. Full charge or supercharge should be fired (as applicable). Target practice ammunition should be used if the firing tables for the target practice ammunition are also applicable to the service ammunition. When target practice ammunition of the proper characteristics is not available, service ammunition should be used. If the service ammunition on hand is not of the type which will ultimately constitute the major portion of the battle allowance, a calibration firing should be conducted with a type of ammunition ballistically

the same as that comprising the interim battle allowance, and another calibration firing should be conducted with ammunition ballistically the same as the new type battle allowance ammunition when this is received. A minimum of eight rounds per gun should be fired.

94. CONDUCT OF FIRE. Calibration firing should be conducted at about mid-range of the battery. The target may be material or hypothetical. When an anchored material target is used, its position must be checked by replotting prior to each shot. Recorded data should include:

Orientation data for plotting board.

Meteorological conditions before, during, and after firing.

Ballistic data used.

Ballistic corrections used.

Assumed muzzle velocity for each gun.

Azimuth of target from base-end stations for each shot.

Azimuth of target boat from base-end stations for each shot.

Range (elevation) and deflection (azimuth) set on gun for each shot.

Azimuth of splash from base-end stations.

Deviations of splash as measured from base-end stations.

Order of firing guns.

Time of firing.

Ammunition used: type, lot, and weight of powder, projectile, and fuze.

Length of recoil for each shot.

Depth of seating for each shot.

Powder pressure developed in each gun.

Camera records.

The shots should preferably be fired when meteorological conditions are as nearly normal and stable as practicable. The wind especially should be

steady and of low velocity, and the guns should be fired in rotation, so that slow changes in ballistic conditions will affect all alike. The rate of fire should be as rapid as is consistent with accuracy, so that conditions will have less time to change. Adjustment of fire during calibration firing will be exceptional, but it should be made when it will improve the accuracy of spotting.

95. OBSERVATION OF FIRE. Observation of fire should be conducted with all means available. The observations should be made by as many plotting and spotting systems as can be used, and the result accepted as true should be a weighted mean of all determinations, the weights being assigned according to the relative reliabilities of the various systems used. Camera records carefully taken from a vessel near the target will be most reliable. If a chronograph is available, it should be used and its record considered in making the analysis of firing. When computing the developed muzzle velocity, the range to the target at the time of splash must be used to take into account any drift of the target. This range must be corrected and any difference between this corrected range (elevation) and the firing range (elevation) must be taken into consideration.

Section IV. CALCULATION OF CORRECTIONS

96. GENERAL. After firing is completed, compute the developed muzzle velocity for each gun. After the developed muzzle velocities are obtained, compute the calibration corrections necessary. This can best be shown by the example which follows.

97. EXAMPLE. A battery of 155-mm guns M1918M1, using projectile AP, M112, fuze BD,

M60 (FT 155-W-1), is to be fired for calibration at a range of 12,000 yards. The best known muzzle velocities are 2,355, 2,348, 2,320, and 2,327 for guns Nos. 1, 2, 3, and 4 respectively. The target is anchored at a range of 12,000 yards and located in such a position in the field of fire that the ranges from the four guns to the target are approximately equal and no correction for range difference is necessary. The azimuth from the directing point midway between guns Nos. 1 and 2 is 160°. The following meteorological message was received just prior to the firing.

MFMMFM
30090
0370995
1382495
2382595
3382596
4392496
5412096
6412097

The following data are assumed:

Map range.....	12,000 yards
Azimuth of target.....	160° (from south)—340° (from north)
Height of site.....	20 feet
Muzzle velocities (from previous firings).	No. 1 gun—2,355 f/s No. 2 gun—2,348 f/s No. 3 gun—2,320 f/s No. 4 gun—2,327 f/s
Powder temperature.....	55° F.
Average weight of pro- jectiles.	102 pounds

a. Range corrected for a change in muzzle velocity due to temperature of powder.

	Gun No. 1	Gun No. 2	Gun No. 3	Gun No. 4
Assumed muzzle velocity (from previous firings) (f/s).....	2,355	2,348	2,320	2,327
Correction for powder temperature of 55° F. (f/s).....	-14	-14	-14	-14
Muzzle velocity corrected for powder temperature (f/s).....	2,341	2,334	2,306	2,313
Standard muzzle velocity (f/s).....	2,360	2,360	2,360	2,360
Difference in corrected muzzle velocity from standard (f/s).....	-19	-26	-54	-47
Muzzle velocity effect (yards).....	-122	-166	-346	-301
Muzzle velocity correction (yards).....	+122	+166	+346	+301
Map range (yards).....	12,000	12,000	12,000	12,000
Range corrected for change in muzzle velocity due to powder temperature (yards).....	12,122	12,166	12,346	12,301

b. Range correction due to meteorological conditions: Line 3 of meteorological message is used.

(1) Wind

$$\begin{array}{rcl}
 \text{Wind azimuth} & = & 3800 \text{ mils} \\
 \text{Target azimuth} & = & 10200 \text{ mils} \\
 & & \underline{-6044 \text{ mils}} \\
 \text{Chart direction} & & 4156 \text{ mils} \\
 \text{of wind.} & & \text{or } 4200 \text{ mils}
 \end{array}$$

	Range effects (in yards)	
	PLUS	MINUS
Range component for wind of 25 mph = 14 mph.....	105	
(2) Temperature (elasticity) for 90° F. = -58.9 yards.....		59
(3) Air density.....	224	
(4) Weight of projectile.....	18	
(5) Totals.....	347	59
(6) Combined effect.....	+288	
(7) Combined correction.....		-288

c. Range corrected for nonstandard ballistic conditions:

	Gun No. 1	Gun No. 2	Gun No. 3	Gun No. 4
Range corrected for change in muzzle velocity (yards).....	12,122	12,166	12,346	12,301
Meteorological correction (yards).....	-288	-288	-288	-288
Range corrected for change in muzzle velocity and meteorological conditions (yards).....	11,834 or 11,830	11,878 or 11,880	12,058 or 12,060	12,013 or 12,010
Corresponding elevation (mils).....	220.1	221.9	228.2	226.4
Height of site correction (mils).....	-.6	-.6	-.6	-.6
Elevation corrected for height of site (mils).....	219.5 or 220	221.3 or 221	227.6 or 228	225.8 or 226

TABLE A. *Splash Deviations (yards)*

Shot Number	Gun No. 1	Gun No. 2	Gun No. 3	Gun No. 4
1	+66			
2		+44		
3			-118	
4				+7
5	-80			
6		+25		
7			+20	
8				-32
9	+20			
10			+70	
11		-95		
12				-55
13		-41		
14	-23			
15			+90	
16				+7
17	+39			
18		-30		
19			+118	
20				+123
21			-42	
22				+14
23		+72		
24	+92			
25			-72	
26	+3			
27		+65		
28				-6
29	-10			
30		-2		
31			+2	
32				+40
Total (algebraic sum)	+107	+38	+68	+98
Mean of total deviation	+13	+5	+9	+12

d. Splash deviations. The battery locates the splashes by azimuths from the base-end stations. These azimuths are set on the plotting board to determine the range to the splash. By subtracting the range to the splash and the range to the target, the range deviation is determined. The deviation obtained from the plotting board is recorded in table A for each shot.

e. New ballistic data. The muzzle velocity developed during the firing is determined from the stripped deviation of the centers of impact of each gun. During the firing, however, another meteorological message is determined, so that the ballistic data are different from that used for the firing. The meteorological message received at this time is as follows:

MFMMFM
 30089
 0390995
 1381595
 2391795
 3391996
 4391996
 5411897
 6411798

Aside from a change in ballistic data, the data are exactly the same as those used for calculating the previous effects. The difference in total ballistic effects due to the new ballistic conditions is calculated and stripped out of the deviations in order to determine the difference in muzzle velocity. The developed muzzle velocity is determined by applying the difference in muzzle velocity to the muzzle velocity originally assumed.

f. Range correction due to meteorological conditions: Line 3 of meteorological message is used.

(1) Wind

Wind azimuth	= 3900 mils	= 10300 mils
Target azimuth	=	-6044 mils
Chart direction		4256 mils
of wind.		or 4300 mils

Range effects
(in yards)

	PLUS (+)	MINUS (-)
Range component for wind of 19 mph = 8.9 mph.....	67	
(2) Temperature (elasticity) for 89° F.		57
(3) Air density.....	224	
(4) Weight of projectile.....	18	
(5) Totals.....	309	57
(6) Combined effect.....	+252	
(7) Combined correction.....		-252

g. Range corrected for nonstandard ballistic conditions:

	Gun No. 1	Gun No. 2	Gun No. 3	Gun No. 4
Range corrected for change in muzzle velocity (yards).....	12,122	12,166	12,346	12,301
Meteorological cor- rection (yards).....	-252	-252	-252	-252
Range corrected for change in muzzle velocity and mete- orological condi- tions (yards).....	11,870	11,914 or 11,910	12,094 or 12,090	12,049 or 12,050
Corresponding eleva- tion (mils).....	221.5	222.9	229.2	227.8
Height of site correc- tion (mil)	- .6	- .6	- .6	- .6
Elevation corrected for height of site (mils).....	220.9 or 221	222.3 or 222	228.6 or 229	227.2 or 227

h. In the following table (table B), the stripped deviation and difference in muzzle velocity are determined, thereby deriving the developed muzzle velocity.

TABLE B. *Derivation of developed muzzle velocity*

Line	Item	Gun No. 1	Gun No. 2	Gun No. 3	Gun No. 4
1..	Uncorrected range (yards).....	12,000	12,000	12,000	12,000
2..	Total correction (difference between uncorrected range and range corrected for "met" message received during firing) (yards).....	-130	-90	+90	+50
3..	Corrected range (yards)	11,870	11,910	12,090	12,050
4..	Corrected elevation (mils).....	221	222	229	227
5..	Elevation used for firing (mils).....	220	221	228	226
6..	Effect of difference in elevation at 12,000 (yards).....	+28	+28	+28	+28
7..	Mean deviation (yards)	+13	+5	+9	+12
8..	Stripped deviation (6) + (7) (yards).....	+41	+33	+37	+40
9..	Muzzle velocity variation (f/s) corresponding to deviation in (8).....	+6	+5	+6	+6
10..	Assumed muzzle velocity (f/s) (from previous firings).....	2,355	2,348	2,320	2,327
11..	Developed muzzle velocity (f/s) (9) + (10).....	2,361	2,353	2,326	2,333

i. Application of calibration correction. The next problem is to determine how to apply a calibration correction. It is not practicable to send separate data to each of four guns. However, it is practicable to send a separate set of data to each platoon of two guns. This latter procedure might necessitate regrouping the guns. In the problem under discussion, the muzzle velocities of registers Nos. 1 and 2, and registers Nos. 3 and 4, are nearly equal. These are consequently grouped as tactical numbers 1, 2, 3, and 4, respectively.

(1) To apply the correction, an additional pointer on the percentage corrector is chosen for the use of the second platoon. The average muzzle velocity for the first platoon is:

$$\frac{2,361 + 2,353}{2} = 2,357 \text{ f/s}$$

and for the second platoon it is:

$$\frac{2,326 + 2,333}{2} = 2,330 \text{ f/s}$$

(2) The first platoon was chosen as the reference platoon and the second as the test platoon. The difference in muzzle velocity for which a correction is necessary is -27 f/s. To determine the correct range percentage to apply, it is now necessary to tabulate for each 2,000 yards the correction necessary in yards and percent of range. The following tabulation (p. 163) and graph (fig. 39) show a comparison between the effects in yards of range for a decrease in muzzle velocity of 27 f/s, and the range effects in yards of corrections of 1.3 percent, 1.4 percent, and 1.5 percent on the percentage corrector. Figure 39 discloses that 1.4 percent of the range will give the least error throughout the entire range of the gun. A range correction of up 1.4 percent is then applied to the second platoon by attaching a second read pointer

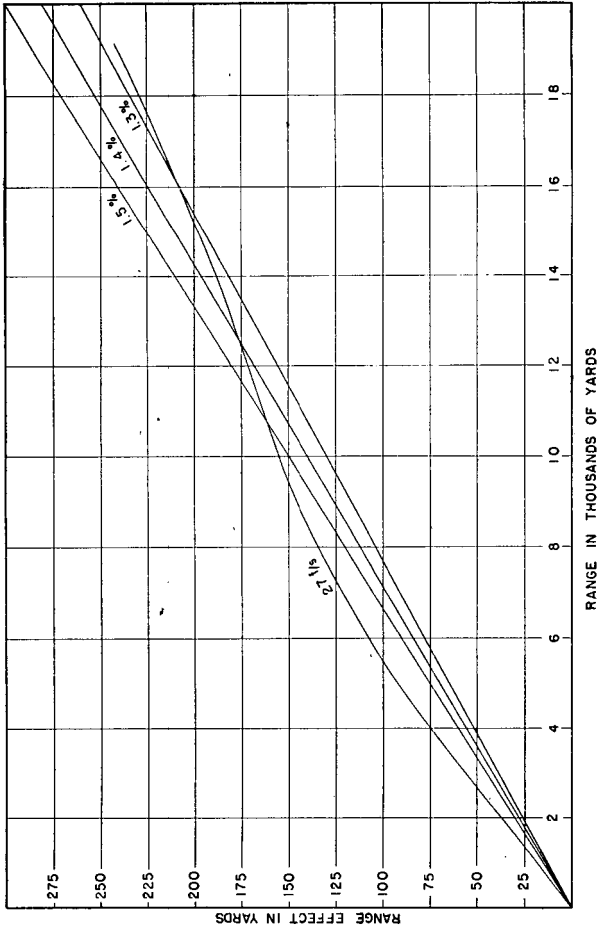

Figure 39. Comparison of range effects based on FT 155-W-1.

to the read pointer for the first platoon. The second pointer is offset by a distance equal to 314 on the correction scale.

Range	Range effects due to 27 f/s decrease in M.V.		Range effects in yards		
	Yards	% Rn.	1.3% Rn.	1.4% Rn.	1.5% Rn.
2,000	-38	1.90	26	28	30
4,000	-76	1.90	52	56	60
6,000	-108	1.80	78	84	90
8,000	-135	1.69	104	112	120
10,000	-157	1.57	130	140	150
12,000	-173	1.44	156	168	180
14,000	-189	1.35	182	196	210
16,000	-208	1.30	208	224	240
18,000	-230	1.28	234	252	270
19,000	-240	1.26	247	266	285

98. EXAMPLE. In this problem, a sequel to the one preceding, it is assumed that several months have elapsed. A record, which included data on the calibration firing already shown, was kept by the battery during this time. The record reveals that the gun with register No. 2 was chosen as the reference piece and that muzzle velocity differences were computed. (Muzzle velocity difference is the variation from the reference piece of each of the other guns with no reference to normal muzzle velocity. The correction for the variation of the muzzle velocity of the reference piece from the normal muzzle velocity is made on the range correction board.)

a. Problem. What mean velocity differences may be determined from these data?

RECORD OF VELOCITY DIFFERENCES

Register No.	Range	No. 1		No. 2		No. 3		No. 4	
Date		Shots fired	Vel. diff.	Shots fired	Vel. diff.	Shots fired	Vel. diff.	Shots fired	Vel. diff.
<i>Calibration</i>									
15 Jan. 1943....	12,000	8	+8	8	0	8	-27	8	-20
<i>Target practice</i>									
6 Feb. 1943....	11,200	8	+10	8	0	10	-24	10	-18
2 June 1943....	13,100	10	+11	10	0	12	-22	12	-17
10 Sept. 1943....	12,800	7	+7	7	0	8	-28	8	-21

b. Solution. As there can be no exact solution to this problem, the following is offered as one means of attaining a satisfactory solution. The first decision entailed a choice of the firings used in the computation. Since all the firings were at approximately the same range, it was decided that all should be used. Next came the matter of weighting factors. The following facts were considered in making the decision: that whereas the rate of fire of this type of gun ordinarily makes pointing not as accurate as is desired for calibration purposes, the results of these target practices were excellent; that the shots were well grouped and close to the target, showing that the pointing was good enough to permit use of the data. Therefore, it was decided to give the calibration firing a weight of three, and each target practice a weight of one. Each practice was weighted according to the square root of the number of rounds fired. The calculation of the weighted means was made as follows (see next page):

Gun register No. 1—

$$\frac{(3 \times \sqrt{8} \times 8) + (\sqrt{8} \times 10) + (\sqrt{10} \times 11) + (\sqrt{7} \times 7)}{3 \times \sqrt{8} + \sqrt{8} + \sqrt{10} + \sqrt{7}} = \frac{150}{17} = 9 \text{ f/s}$$

Gun register No. 2—

Reference piece (no difference).

Gun register No. 3—

$$\frac{(3 \times \sqrt{8} \times -27) + (\sqrt{10} \times -24) + (\sqrt{12} \times -22) + (\sqrt{8} \times -28)}{3 \times \sqrt{8} + \sqrt{10} + \sqrt{12} + \sqrt{8}} = \frac{-460}{13} = -26 \text{ f/s}$$

Gun register No. 4—

$$\frac{(3 \times \sqrt{8} \times -20) + (\sqrt{10} \times -18) + (\sqrt{12} \times -17) + (\sqrt{8} \times -21)}{3 \times \sqrt{8} + \sqrt{10} + \sqrt{12} + \sqrt{8}} = \frac{-345}{18} = -19 \text{ f/s}$$

Guns with registers Nos. 1 and 2 were then grouped as the first platoon and guns with registers Nos. 3 and 4 were grouped as the second platoon. The first platoon had an average variation of muzzle velocity of $\frac{(+9) + (+0)}{2}$ or +5 f/s. The second platoon had an average variation of $\frac{(-26) + (-19)}{2}$ or -23 f/s. The second platoon developed an average of 28 f/s less muzzle velocity than the first platoon and a correction of -28 f/s was made for this.

CHAPTER 8

SPOTTING

Section I. GENERAL

99. PURPOSE. The purpose of spotting is to obtain the deviation of the splash from the target. If the meteorological station has provided an accurate meteorological message and if battery officers and noncommissioned officers have prepared properly for firing, hits can be expected even on the first salvo. If the center of impact is not on the target, however, fire adjustment, based on prompt and accurate spotting, is necessary. The spotting section, therefore, forms an essential element in the battery organization. Its function is to sense the shots as *over* or *short* and *right* or *left*, if the battery is using the bracketing method of fire adjustment; or to determine both the magnitude and sense of the deviations if using the magnitude method of fire adjustment.

100. TYPES OF SPOTTING. The following types of spotting are usually employed:

a. Axial spotting. In axial spotting the lateral deviations or range sensings are obtained from a single station near the directing point.

b. Flank spotting. Flank spotting consists of determining overs and shorts from a station on the flank. The line of sight from the spotting station to the target must be approximately perpendicular to the gun-target line. Flank spotting is not used extensively.

c. Bilateral spotting. In bilateral spotting the range deviations, and at times the lateral deviations, are obtained by combining the angular deviations observed from two stations some distance apart. (For a fuller discussion, see FM 4-15.)

d. Radar spotting. At the time this manual goes to press, methods for employment of radar for spotting are under development, but detailed information is not available for publication.

Section II. LATERAL SPOTTING

101. AXIAL SPOTTING. Axial spotting provides the best means for reading lateral deviations. This necessitates a station with sufficient height of site to see the splashes and the target. For accuracy, the gun-target station angle should not be more than 1° . This angle is a function not only of the distance of the station from the guns but also of the range. Using this method, the spotter tracks the target until the splash occurs and then reads the lateral deviation into a telephone connected directly to the lateral adjustment board. Since this method involves only one operator and no intermediate mechanical spotting board, the possibility of introducing errors is reduced.

102. BILATERAL SPOTTING. It is not always possible to obtain lateral deviations from an axial station. At such times, the lateral corrections can be obtained from the same spotting board that is being used to determine range corrections. This system is not as satisfactory as axial spotting for determining lateral deviations.

Section III. RANGE SPOTTING

103. AXIAL SPOTTING. a. Because of its simplicity and speed, axial spotting for range is nor-

mally used by rapid-fire batteries. Because it is generally not accurate at the longer ranges and because the rate of fire of slow-firing batteries allows sufficient time to compute corrections based on the more precise bilateral spotting, axial spotting is not normally used for slow-firing batteries as long as bilateral spotting is possible. With proper preparation for firing and careful adjustment of fire, lateral deviations should be slight; and in battle the normal targets for 155-mm or 6-inch guns are large enough to silhouette the splash if the shots are short. If the shots are over, either the splashes are not seen, or they are seen, as they rise over the target. It has been pointed out that for axial observation of lateral deviations, the angle gun-target station should not exceed 1° ; for axial range spotting this angle should not exceed 5° .

b. Although sensing the shots that are in line with the target is usually a simple process, certain precautions are necessary. Light mists or ground swells near the target may cause shots that are considerably short to appear as hits. For this reason, a spotter should not sense shots as hits unless they actually hit the target. For the same reason, he should not try to estimate the size of the deviation. Sensings like "way short" or "close over," intended to help the adjuster, are usually misleading and often wrong. Serious errors in firing occur if spotters are instructed to sense every shot definitely. This is especially true when spotters try to sense shots that are not in line with the target. Consequently, spotters should be trained to describe as "doubtful" any shots that they cannot sense with certainty.

104. FLANK SPOTTING. This method, where it can be used, is probably the easiest method of determining overs and shorts from a single station. Ordinarily, if the splash can be seen at all, it can be

sensed correctly. However, the angle, gun-target spotting station, must be between 75° and 105° for satisfactory results. The movement of the target may make it impossible to keep this angle within the prescribed limits. As this angle at the target departs from 90° , it will be apparent that unless lateral adjustment is very good, splashes that are very close to the target, in range, may appear over while actually short, or vice versa, due to the point of view of the spotter. The possibility of locating a station on the flank will depend on the terrain conditions. The need for long communication lines from spotting station to battery is a decided disadvantage when compared with the minimum communications required for axial spotting. Flank spotting ordinarily will not be practical under battle conditions.

105. BILATERAL SPOTTING. When a battery has a bilateral spotting system, spotters in two different stations read the angular deviation of the splash from the target. These readings are transmitted to and set on the spotting board. Range and lateral corrections are then read in reference numbers (indicating percent of range and degrees of deflection or azimuth) from the platen of the spotting board. In some cases the lateral correction is obtained from an azimuth instrument located in an axial station, in which case only the range correction is read from the spotting board. (See FM 4-15.)

Section IV. ACCURACY OF INSTRUMENTS

106. GENERAL. The accuracy attained in spotting systems will ordinarily depend on the accuracy of the personnel rather than on the accuracy of the instruments themselves. Because of this, the training of spotters is of great impor-

tance and the range officer should take advantage of every opportunity to increase the efficiency of his spotters. Improvised devices may be used. Whenever possible, spotters should be required to spot the practices of other batteries. By such procedures, their efficiency can be greatly increased. A discussion of the instruments used in spotting is given in the following paragraphs.

107. THE M1910A1 AZIMUTH INSTRUMENT.

The M1910A1 azimuth instrument is the best instrument for spotting. (See ch. 7, FM 4-15.) Etched on the reticle of the telescope are graduations representing angular deviations. These occur every two-hundredths of a degree. Even the most accurate observer, therefore, in attempting to read between graduations, could easily make an error of one-hundredth of a degree, particularly when a large splash occurs. All spotters should be trained to read on the center of the splash.

108. THE DEPRESSION POSITION FINDER.

The depression position finder can be used for spotting in an emergency when the instrument is not being used for position finding. The observer should not be required to read range and azimuth for position finding and at the same time determine the deviation of splashes. When the depression position finder is located near the battery, it can be used to determine range sensing for bracketing adjustment by waterlining the target and determining the sense of the splash by its position above or below the horizontal cross bar. However, any azimuth instrument will serve equally as well for this type of spotting. Various attempts have been made to determine the magnitude of range deviations by reading first the range to the target and then the range to the splash. This procedure is not recommended as it requires subtrac-

tion and conversion to percent of range, so that the deviation can be used on the fire adjustment board.

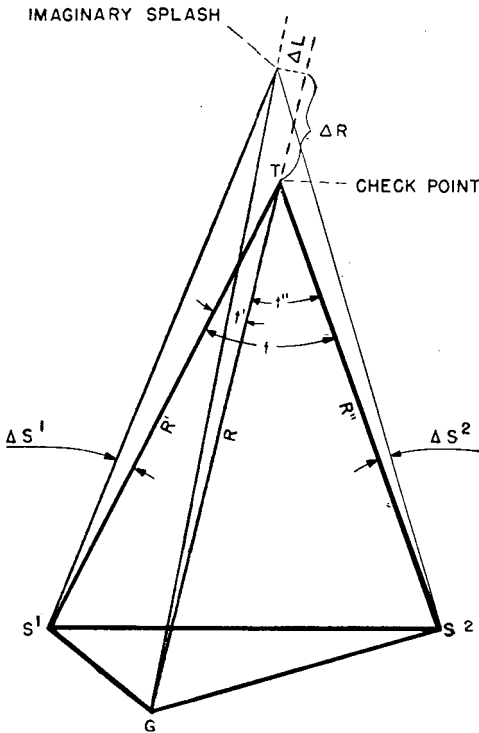

Figure 40. Computation of spotting board error.

109. THE SPOTTING BOARD. a. General formulas.

The spotting board may be checked mechanically, as described in FM 4-15. Such a check is ordinarily sufficient and should be regularly carried out. It does not, however, check the curves on the deviation disks, nor is it a complete check of the readings on the spotting scale. A more complete check can be made by solving a problem

on the spotting board and comparing the results thus obtained with the results from mathematical computation. This can be done by the following formulas: Formula (1) is used when S^1 is on the left; formula (2) when S^1 is on the right.

$$\Delta R \text{ (in yards)} = -\frac{R' \cos t''}{\sin t} \Delta S^1 + \frac{R'' \cos t'}{\sin t} \Delta S^2 \quad (1)$$

$$\Delta R \text{ (in yards)} = +\frac{R' \cos t''}{\sin t} \Delta S^1 - \frac{R'' \cos t'}{\sin t} \Delta S^2 \quad (2)$$

$$\Delta L \text{ (in yards)} = \frac{R' \sin t''}{\sin t} \Delta S^1 + \frac{R'' \sin t'}{\sin t} \Delta S^2 \quad (3)$$

In the formulas and the figure:

- G = Directing point of the battery.
 - S^1, S^2 = Spotting stations.
 - T = Target.
 - ΔR = Range deviation of the splash from the check point in yards. (Overs are plus; shorts are minus.)
 - ΔL = Lateral deviation of the splash from the check point in yards. (Left deviations are minus; right deviations are plus.)
 - ΔS^1 = Angular deviation in radians of the splash from the check point as read at S^1 .
 - ΔS^2 = Angular deviation in radians of the splash from the check point as read at S^2 .
 - R = Distance from the directing point to the check point.
 - R' = Distance from S^1 to the check point.
 - R'' = Distance from S^2 to the check point.
 - t = Angle S^1TS^2 .
 - t' = Angle S^1TG .
 - t'' = Angle S^2TG .
- Angular deviations to the right are plus and to the left are minus.

The proper sign must be carried over when substituting in the equation.

NOTE. If the angular deviation is expressed in degrees, multiply by 0.01745, or, if in mils, by 0.0009817, to convert to radians.

b. Orientation. Before the problem is run the board should be oriented, using the orientation data for the spotting system. The position-finding data could be used, but if the spotting stations are not in the observation stations, solving the problem will check only the mechanical accuracy of the board. It will not check the orientation.

c. Choice of the check point. Any point in the field of fire may be used as a check point. For a thorough check of the board, several points in different areas in the field of fire may be chosen. The points may be located by coordinates, or by range and azimuth from the directing point or one of the spotting stations.

d. Determination of check point data. In order to use the formulas given in subparagraph a above, it is necessary to determine the range and azimuth of the check point from S^1 , S^2 , and G . These data may be determined by one of the following methods:

(1) *Trigonometric computation.* The ranges and azimuths of the check point from the various stations can be obtained by a solution of the triangles involved in a manner similar to that given for the calculation of check points on a plotting board. (See pars. 50 and 51.)

(2) *Graphical solution on plotting board M1923 or M1.* When either the M1923 or the M1 plotting board is used, the distance and azimuth given should be from the station represented by the platen pivot to the check point. The platen, oriented to the S^1 - S^2 - G triangle, can then be run out on the plotting arm the given distance to establish the correct triangle. The method is best explained by an example:

(a) *Example.* The orientation data of a certain battery are as follows:

	<i>Distance</i> (yards)	<i>Azimuth</i> (degrees)
S^1 to S^2	5,340	347.03
G to S^1	634	199.84
G to S^2	4,819	342.94

A check point is taken at a distance of 16,000 yards and at an azimuth of 270° from S^2 (see fig. 40). What is the distance and azimuth to the check point from S^1 and from G ?

(b) *Solution.*

1. Orient the board, putting S^2 at the platen pivot, S^1 at the master key, and G at the gun push button.
2. Set the plotting arm at the azimuth of S^2 to check point (270°).
3. Clamp the platen in its orienting position and run it out on the plotting arm until the platen index indicates the distance from S^2 to the check point (16,000 yards).
4. Bring the relocating arm to the master key; read and record the distance and azimuth from S^1 to the check point (17,970 yards; 286.83°).
5. Move the relocating arm to the gun push button; read and record the range and azimuth from the directing point to the check point (18,010 yards; 284.82°).

(3) *Graphical solution by plotting board M3, M4, or similar type.* When this type of plotting board is equipped with station arm centers corresponding to the location of the spotting station, the determination of the check point data is comparatively simple. The arms are set up for the proper station plugs and the check point is located in range and azimuth along the gun arm. The station arms are then used to determine the range and azimuth from each spotting station to the check point.

e. Setting up the spotting board. With the data found in subparagraph d it is now possible to set up the spotting board.

(1) Orient the spotting board.

(2) Set in the range and azimuth from the DP to the check point (18,010 yards; 284.82°).

(3) The spotting scales should now read the range from the proper spotting station to the check point.

(4) Choose an angular deviation from S^1 (for example, 318), and set it on the S^1 disk. Choose an angular deviation from S^2 (for example, 257), and set it on the S^2 disk. These two deviations may also be written as $L 0.18^\circ$ and $R 0.43^\circ$ respectively.

(5) Read the range correction in percent of the range and the lateral correction in degrees from the grid.

f. Mathematical solution of the problem. If the same values which were used in the above mechanical solution of the problem are substituted in the formulas, the computed deviation in yards should be the same as the board's solution.

(1) *Example.* The following data have been determined or assumed in the preceding paragraphs:

	Yards	Azimuths
S^1 to S^2	5,340	347.03°
G to S^1	634	199.84°
G to S^2	4,819	342.94°
$R = G$ to check point.....	18,010	284.82°
$R' = S^1$ to check point	17,970	286.83°
$R'' = S^2$ to check point.....	16,000	270.00°

$$t = \text{angle } S^1TS^2 (286.83^\circ - 270.00^\circ) = 16.83^\circ$$

$$t' = \text{angle } S^1TG (286.83^\circ - 284.82^\circ) = 2.01^\circ$$

$$t'' = \text{angle } S^2TG (284.82^\circ - 270.00^\circ) = 14.82^\circ$$

$$\Delta S^1 = \text{angular deviation from } S^1 = L 0.18^\circ = -.18^\circ$$

$$\Delta S^2 = \text{angular deviation from } S^2 = R 0.43^\circ = +.43^\circ$$

Determine values of ΔR and ΔL .

(2) *Solution.* Since S^1 is on the left, formula (1) in subparagraph a preceding is used. Therefore:

$$\Delta R = - \frac{R' \cos t''}{\sin t} \Delta S^1 + \frac{R'' \cos t'}{\sin t} \Delta S^2$$

The values of ΔS^1 and ΔS^2 are converted into radians and substituted in the formula. Care must be taken to use the correct signs. The formula then becomes:

$$\Delta R = - \frac{17,970 \cos 14.82^\circ}{\sin 16.83^\circ} (-.18 \times .01745) + \frac{16,000 \cos 2.01^\circ}{\sin 16.83^\circ} (.43 \times .01745)$$

The logarithmic solution is given below.

log 17,970	=	4.25455
log cos 14.82°	=	9.98531 - 10
log .18	=	9.25527 - 10
log .01745	=	8.24180 - 10
log numerator	=	11.73693 - 10
log sin 16.83°	=	9.46170 - 10
log quotient	=	2.27523
quotient	=	188.5
log 16,000	=	4.20412
log cos 2.01°	=	9.99973 - 10
log .43	=	9.63347 - 10
log .01745	=	8.24180 - 10
log numerator	=	12.07912 - 10
log sin 16.83°	=	9.46170 - 10
log quotient	=	2.61742
quotient	=	414.4

$$\begin{aligned} \Delta R &= 188.5 + 414.4 \\ &= +603 \text{ yards} \\ &= 603/18010 = 3.3 \text{ percent OVER.} \end{aligned}$$

(The spotting board correction should read 267.)

The lateral effect in yards may be computed by using the formula:

$$\Delta L = \frac{R' \sin t''}{\sin t} \Delta S^1 + \frac{R'' \sin t'}{\sin t} \Delta S^2$$

Substituting the given values in this formula, we have:

$$\Delta L = \frac{17,970 \sin 14.82^\circ}{\sin 16.83^\circ} (-.18 \times .01745) + \frac{16,000 \sin 2.01^\circ}{\sin 16.83^\circ} (.43 \times .01745)$$

log 17,970	=	4.25455
log sin 14.82°	=	9.40787 - 10
log .18	=	9.25527 - 10
log .01745	=	8.24180 - 10
log numerator	=	<u>11.15949 - 10</u>
log sin 16.83°	=	9.46170 - 10
log quotient	=	<u>1.69779</u>
quotient	=	49.9
log 16,000	=	4.20412
log sin 2.01°	=	8.54498 - 10
log .43	=	9.63347 - 10
log .01745	=	8.24180 - 10
log numerator	=	<u>10.62437 - 10</u>
log sin 16.83°	=	9.46170 - 10
log quotient	=	<u>1.16267</u>
quotient	=	14.5

$$\Delta L = -49.9 + 14.5$$

$$\Delta L = -35 \text{ yards}$$

$$\Delta L \text{ (degrees)} = \frac{-35}{18,010 \times 0.01745} = -0.11^\circ$$

(The spotting board correction should read 311.)

CHAPTER 9

ADJUSTMENT OF FIRE

Section I. GENERAL

110. THE PROBLEM. a. Adjustment of fire is the process of determining and applying to the firing data any corrections necessary to place the center of impact on the target and keep it there. It is necessary because, even after the most careful preparations for firing, the battery may not open up precisely on the target. It is continuous throughout firing because, even if the center of impact has been placed on the target initially, or at some time during the firing, it may not stay on the target.

b. Principles and rules for the adjustment of fire, based on experience, have been prepared in order to standardize procedure. The rules are simple and are designed to give rapid adjustment without waste of ammunition. It is essential that the fire adjusters know these principles and rules. When special situations occur which appear to be outside the scope of these rules, the adjusters must base their decisions on sound judgment and common sense.

111. BASIC PRINCIPLES. a. Adjustment of fire is designed to correct for systematic errors only and not for accidental errors. Proper preparation for firing, by reducing both systematic and accidental errors, will place the center of impact near

the target. Fire adjustment is not a cure-all; it is not intended as a substitute for careful and continual preparation for firing.

b. The fire adjusters should have a general knowledge of the effects of nonstandard conditions (see ch. 2, sec. III) and should be familiar with the application of probability and of the theory of errors to artillery firing.

c. The practical unit of measure for use in the adjustment of fire is the probable error. The value to be used can be obtained from one of the following sources:

(1) A study of previous firings of the battery.

(2) Table I, TM 4-235.

(3) One and one-half times the firing table probable error.

d. Fire will be very effective if the center of impact of shots is within one probable error of the target. In general, a *range* correction should be made if the center of impact is more than a one-half probable error from the target, while a *lateral* correction should be made if the center of impact is more than one probable error from the target.

e. Occasionally a wild shot will be fired. A shot is wild if its impact is more than four probable errors from the center of dispersion. It should be disregarded in determining an adjustment correction. Obviously a wild shot cannot be identified as such until enough rounds have been fired to give a center of impact that can be considered close to the center of dispersion.

f. When it is known that due to "warm-up" or "clean-gun" effect, the first shots from a battery fall outside the limits of the dispersion zone, they must not be considered in range adjustment of fire.

112. METHODS OF RANGE ADJUSTMENT. a. **Magnitude method (deviations measured).** In this method of fire adjustment, the magnitude and sense of the range deviation of each shot or salvo

are determined and the impacts are plotted graphically on the fire adjustment board. (See FM 4-15.) The accuracy of the corrections determined on the board depends on the accuracy of the known data on the center of impact. Corrections can be determined accurately with the expenditure of very few rounds; but this method of spotting, being slow, makes magnitude adjustment impracticable with rapid-fire guns. It is, therefore, the standard method of fire adjustment with large-caliber, long-range guns (guns of 8-inch or larger caliber except 8-inch turret batteries) which have a relatively slow rate of fire. (For further discussion, with illustrations, see sec. II.)

b. Bracketing method (deviations sensed). This method is used when only the sensings of deviations are obtained. Corrections, determined on the bracketing adjustment chart (see FM 4-15), are based on the relative number of overs, shorts, and hits. An equal number of overs and shorts obtained with the same correction is a good indication that the center of impact is very close to the target. It is the normal method of adjustment for rapid-fire guns. It is also a good alternate method for large-caliber guns when the magnitude of deviations can no longer be obtained. (See sec. III.)

113. METHOD OF LATERAL ADJUSTMENT. Lateral adjustment is normally conducted in a manner similar to the magnitude method of range adjustment. This method is used for all types of guns. (See sec. IV.)

114. METHOD OF APPLYING CORRECTIONS.
a. Range corrections are applied as a percentage of the range. This method gives linear corrections which vary with the range in a manner similar to systematic errors. When a correction is found necessary, it should be made to the nearest 1/10th of 1 percent of the range.

b. Corrections in direction are applied as flat angular corrections. This results in the application of linear corrections that vary in proportion to the range.

115. COORDINATION OF THE ADJUSTERS AND THE BATTERY. a. **Timing.** Since one or more shots may be fired before a correction can take effect, it is especially important that the fire adjusters know when each correction is taking effect on the fall of shots. To insure this, a careful study of the timing system of the battery should be made. The following elements of timing must be known:

(1) Length of the observing interval.

(2) Time required for a given set of data to pass through the plotting room.

(3) Time at which data are transmitted to the guns.

(4) Time required for setting data on the guns.

(5) Length of the firing interval.

(6) Time of flight of the projectile for all ranges.

(7) Time required to spot deviations, calculate corrections, and apply corrections to the firing data.

b. **Timing diagram.** It will be found convenient to draw a diagram similar to the one shown in figure 41. Numerals are used to follow the flow of data. Thus, the observations at O_2 furnish the data sent to the guns at D_2 . The guns are fired with these data at F_2 , and the splash from F_2 occurs at S_2 . Arrows are used to trace an adjustment correction from the time the deviation is spotted to the time an adjustment based on this deviation is applied to the firing data; thence to the firing of the guns with that correction; and finally to the spotting of the first shot to be affected by the correction. Each horizontal line represents a stage in the flow of data. The horizontal scale is drawn

against time, with the observing interval as the measuring unit.

(1) *Example.* A battery of 155-mm guns, M1918M1, is firing HE shell M101, with fuze, P.D. M51, supercharge, at a range of 12,000 yards. The following data are determined by careful timing of the functioning of the battery:

Observing interval.....	20 seconds
Time consumed for operation in plotting room.....	15 seconds
Data sent to the guns.....	Just after each T.I. bell
Time used in loading and pointing the guns.....	18 seconds
Firing interval.....	20 seconds
Time of flight (from firing tables).....	25 seconds (approx.)
Time used in spotting, de- termining adjustments, and applying corrections to firing data.....	10 seconds

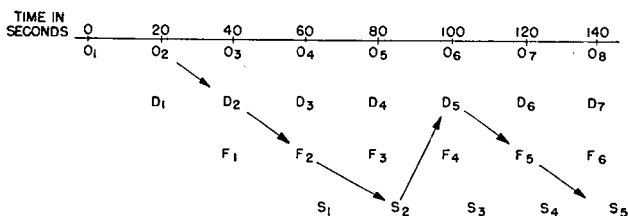

O (time of observation). *D* (time a given set of data
F (firing of the guns). is transmitted to the
S (occurrence of splash). guns).

Figure 41. Timing diagram for example, paragraph 115.

(2) This figure shows that at this particular range the spots from the second salvo are received in time to make adjustments which will affect the fifth salvo, and that consequently the third and fourth salvos are fired with the old correction. However, if the time of flight had been longer, adjustment corrections could not have been applied

until the sixth salvo, and three salvos would have been fired with the old corrections. The fire adjusters should be provided with charts for different ranges showing the number of shots which will be fired before a correction takes effect. (For additional examples, see sec. II.)

c. Coordination with the plotter. Deviations of shots will occur when errors have been made in prediction. The plotter will be aware of this as soon as the plotted positions of the target depart from the expected course upon which predictions were based. If the adjuster then makes an adjustment at the same time as the plotter rectifies the predicted course, a double correction will be made. To prevent this, the adjuster should be notified whenever deviations can be expected as a result of erroneous prediction.

116. CLASSIFICATION OF FIRE. For purposes of adjustment, firing is divided into two phases, *trial fire* and *fire for effect*.

a. Trial fire is initial fire conducted deliberately to determine as accurately as possible an initial adjustment correction for the battery. It is conducted deliberately to reduce the confusion connected with opening fire.

b. Fire for effect is conducted at the maximum rate that will accomplish the tactical aim of the battery. It is entered with the correction determined during trial fire. Further corrections are applied to the firing data as they become necessary.

c. Some batteries will be able to open fire at full rate if the state of training of personnel and information concerning the ammunition and the meteorological message are such that the battery can be reasonably certain of opening fire with the target in the hitting area. The rules of adjustment are substantially the same for these batteries, except that there will be no delay for the application of initial corrections.

Section II. MAGNITUDE METHOD OF RANGE ADJUSTMENT

117. GENERAL. a. In this method of adjustment the magnitude and the sense of range deviations are the basis for determining the range correction. To obtain these deviations, a bilateral spotting system and a spotting board are used. The spotting observer in each bilateral spotting station observes the splash and transmits the splash scale reading to the spotting board. The spotting board then locates the splash with respect to the target. The spotting board grid on which the splash is located is graduated to give, in reference numbers, the correction which, if used, would have placed the splash on the target. The corrections for successive splashes are then sent to the fire adjustment board where they are averaged to determine the range adjustment correction, which in turn is applied to the percentage corrector or to the gun data computer, as the case may be.

b. On the fire adjustment board splashes are plotted (in terms of corrections) in such a way that they are stripped of the adjustment corrections with which they were fired. This allows the fire adjuster to base a correction on the center of impact of a series of shots, whether or not all the shots were fired with the same correction.

118. TRIAL FIRE. In trial fire four shots are fired at the target, either by single shot or by salvo. If the deviation of the first shot or of the center of impact is large, a full correction is made in order to bring the rest of the trial shots closer to the target. This will permit more accurate measurement of the deviations. If the center of impact of a two-gun salvo is more than two probable errors from the target, or if the first shot falls more than three probable errors from the target, a full

correction is ordered. The center of impact of all the shots of trial fire, taking into consideration any correction applied during trial fire, furnishes the basis for the correction to be applied at the commencement of fire for effect. All guns of a battery should be used in trial fire.

119. FIRE FOR EFFECT. a. The correction determined from trial fire is used to commence fire for effect. Four rounds are fired, and their center of impact is combined with that of the four rounds of trial fire to form a basis for a correction. If the center of impact of the eight shots is more than a half probable error from the target, a correction is immediately ordered. Thereafter, when each series of four impacts is plotted, a correction is made if necessary. Each correction is based on the center of impact of the last eight shots fired. It will be noted that shots fired with different corrections can be considered together in determining a new correction.

b. Although not absolutely necessary, it is better to wait for units of four impacts. This will eliminate confusion and errors in operating the fire adjustment board.

c. If one shot of a series of four is lost, the center of impact of the other three is found and used in considering corrections.

120. DESCRIPTION. a. It is assumed that the fire adjustment board M1 is being used. (See FM 4-15.) On this board the system of reference numbers found on most range devices is used; that is, 300 represents a zero correction and the digit in the unit place of the 300 represents tenths of one percent. For example, 315 represents a correction of UP 1.5 percent of the range. A shot plotted at 315 is actually short 1.5 percent and requires an UP 1.5 percent correction.

b. In the examples given the standard conventions and symbols have been used as indicated below:

(1) A cross (\times) is used to denote the spotted deviation of a single shot. A cross with an exponent is used to denote the spotted deviation of the center of impact of a salvo, the exponent being the number of shots in the salvo.

(2) A dot (.) is used to indicate the computed center of impact of the shots in a salvo. If a cross with an exponent has been used, as in (1) above, the dot is not needed.

(3) A small circle (o) indicates the center of impact of a series of four shots.

(4) A check mark (\checkmark) is used to show when a correction has been ordered.

(5) The number in the check mark (\checkmark with a number inside a square root symbol) indicates in reference numbers the correction ordered.

(6) The target line is drawn vertically along the line corresponding to the correction with which shots have been fired. When a new correction is ordered, the target line is shifted to the line of the new correction after all shots fired with the old correction have been plotted. A horizontal line joining the old and new positions of the target line is drawn just above the horizontal line on which are plotted the first shots fired with the new correction.

(7) A different horizontal line is used for each salvo in both trial fire and fire for effect. When trial fire is conducted by single shots, shots fired with different corrections are plotted on different lines. The board shows at all times a chronological record of the fire adjustment.

c. Spotted deviations, in the form of range correction reference numbers, are plotted when received from the spotting board. The shots are plotted with the target line at the 300 line on the chart. The center of impact of the first salvo, if

trial fire is by salvo, is determined and indicated by a dot. If the dot is more than two probable errors from the target, a full correction is immediately ordered. A check mark (\checkmark) is placed on the line of the correction ordered, and the value of the correction is written in the check mark. Since a correction in trial fire will take effect on the next shots, the target line is immediately shifted, as described in b above. The next salvo is plotted from the new target line, and the center of impact of the two single shots or one salvo determined as before. The center of impact of the four single shots (or both salvos midway between the two dots) is found and indicated by a circle. If this circle is more than a half probable error from the target line, another correction is immediately ordered. The check mark is made, and the target line shifted as before. If trial fire is conducted by single shots, and if the first shot is more than three probable errors from the target, a full correction is ordered and applied to the succeeding shots. The target line is moved immediately, and subsequent shots of trial fire are plotted on a new line of the graph. The centers of impact are determined as for two-gun salvos.

d. The center of impact of the first four shots of fire for effect is determined just as that of the four shots of trial fire, and the center of impact of the eight shots is found by taking the mean of the two centers of impact of four shots. No symbol is used to indicate the center of impact of eight shots. Again, if this is more than a one-half probable error from the target line, the full correction is immediately ordered, and the check mark and value of the correction are entered. The target line is moved just before the first salvo fired, with the new correction is plotted. The center of impact of shots 5 to 8 is determined, and a correction considered on the basis of the center of impact of these four and the previous four shots. Two or more

shots falling at the same point are indicated by a cross (X) with an exponent indicating the number of shots. (The same symbol is also used to indicate the center of impact of a salvo when spotting is by salvos.) If one shot in a series of four is lost, the center of impact of the other three should be estimated.

e. At times during firing, only the sensings of shots may be obtained. The adjuster may shift immediately to a bracketing chart (see sec. III), in which case the sensings of the last four shots on the magnitude chart can be used in considering the first correction on the bracketing chart; or he may plot the sensings on the magnitude chart. This is done by plotting hits on the target line, overs two probable errors to the left, and shorts two probable errors to the right of the target line. Centers of impact are then determined and corrections ordered just as when the magnitude of the deviations is received. In this way deviations which have only been sensed can be considered with deviations which have been measured. It must, of course, not be expected that corrections so determined will be as accurate as when all deviations are measured.

f. **Example 1.** The situation is as follows:

Armament.....	Two 16-inch guns
Fire-control equipment..	{ Gun data computer M1 Spotting board M7 Fire adjustment board M1
Firing interval.....	About 60 seconds
Time of flight.....	66 seconds
Time of spotting and applying corrections...	About 15 seconds
Probable error (DAPE)..	0.5 percent

The timing diagram shows that after fire for effect had started, the length of the time of flight made it possible for two shots to be fired before a correction could be applied. Since a gun data computer was used, the shots were not fired together,

but each gun was fired at approximately 1-minute intervals. Since the observation data are continuous, there is no observing interval. The time interval used in plotting the timing diagram is 60 seconds. Since the data computer operates without dead time, the observation (O) and data (D) lines can be omitted.

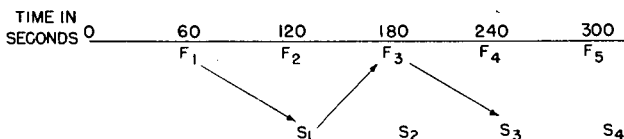

Figure 42. Timing diagram for example 1, paragraph 120.

Even though the guns are not actually fired by salvo, it is convenient to plot shots in pairs to simplify the determination of centers of impact. The first two shots of trial fire were plotted at 295 and 283, giving a center of impact at 289. Since this center of impact was more than two probable errors from the target, the correction of 289 was ordered immediately. It was applied to the third and fourth trial shots, and the target line was moved accordingly. The center of impact of the four trial shots indicated a correction of 293. Since this was more than a half probable error from the target line, the correction was ordered, and fire for effect was begun with this correction. A correction was considered on the basis of the four trial shots and the first four shots of fire for effect, but none was ordered because the center of impact was less than a half probable error from the target line. The fifth and sixth shots of fire for effect both fell at 308 and were plotted with one cross and an exponent of 2. In this case, of course, no dot is needed to indicate the center of impact of the two shots. A correction of 296 was ordered on

the basis of the first eight shots of fire for effect. Since this took effect on the eleventh and twelfth shots, the target line was not moved until just before these shots.

Shot No.	Adjustment correction with which fired	Point of impact	Correction ordered
T-1	300	295	
T-2	300	283	289
T-3	289	300	
T-4	289	316	293
S-1	293	310	
S-2	293	302	
S-3	293	305	
S-4	293	291	
S-5	293	308	
S-6	293	308	
S-7	293	302	
S-8	293	298	296
S-9	293	311	
S-10	293	299	
S-11	296	284	Correction 296 takes effect
S-12	296	308	

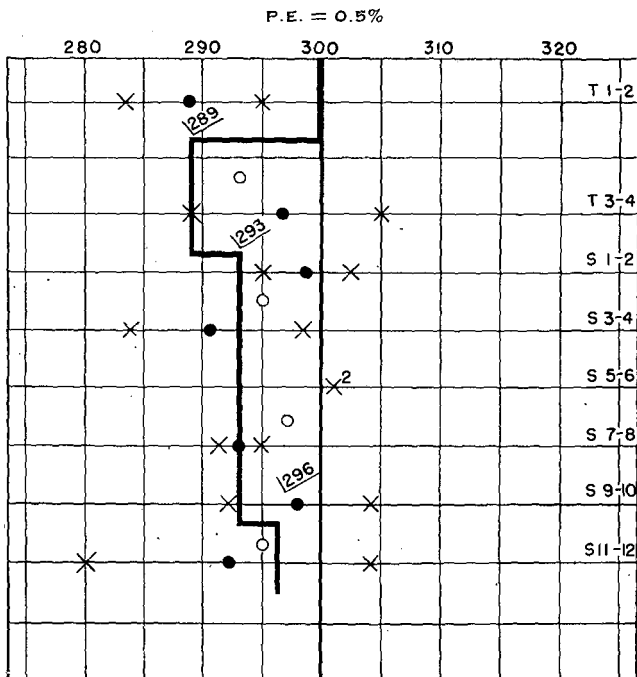

Figure 43. Fire adjustment chart (magnitude method), example 1, paragraph 120.

g. Example 2. The situation in this example is as follows:

Armament.....	Four 8-inch railway guns
Observing interval.....	20 seconds
Firing interval.....	The two platoons fire alternately every 20 seconds
Time of flight.....	30 seconds
Time for spotting and applying adjustment corrections.....	About 10 seconds
Probable error (DAPE).....	0.6 percent

The timing diagram for this battery is shown in figure 44.

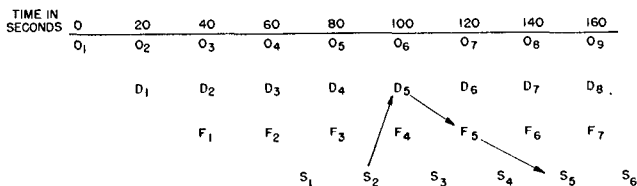

Figure 44. Timing diagram for example 2, paragraph 120.

The timing diagram shows that during fire for effect, two salvos were fired before a correction ordered could take effect. Trial fire was conducted in salvos by platoons. The first platoon fired one salvo. The center of impact of this salvo fell at 308. Since this was less than two probable errors from the target, no correction was ordered. The second trial salvo was fired by the second platoon. The center of impact of the two trial salvos was 311, and accordingly that correction was ordered and took effect immediately. The center of impact of the first two salvos of fire for effect, coupled with that of the two trial salvos, gave a correction of 307, which was ordered and which took effect on the fifth salvo of fire for effect. Just before that salvo landed, communications with one of the spotting stations were disrupted. Provisions had been made to spot from the battery commander's station and to adjust fire by plotting the sensings from this station on the magnitude adjustment chart. Hits were plotted on the target line, shorts two probable errors to the right, and overs two probable errors to the left. The center of impact of the third and fourth salvos (measured) was averaged with that of the fifth and sixth salvos (sensed) to determine the next correction, 315, which took effect on the ninth salvo of fire for effect. The tabulation follows:

Salvo No.	Adjustment correction with which fired	Point of impact	Adjustment correction ordered
T-1	300	302, 314	
T-2	300	321, 307	311
S-1	311	280, 294	
S-2	311	286, 308	307
S-3	311	307, 295	
S-4	311	308, 314	
S-5	307	Over, short*	Correction 307 takes effect. Communications from spotting station broken.
S-6	307	Short, short*	315
S-7	307	Short, short*	
S-8	307	Over, short*	
S-9	315	Hit, short*	Correction 315 takes effect.
S-10	315	Hit, over*	

*Only sensings from B.C. station were available.

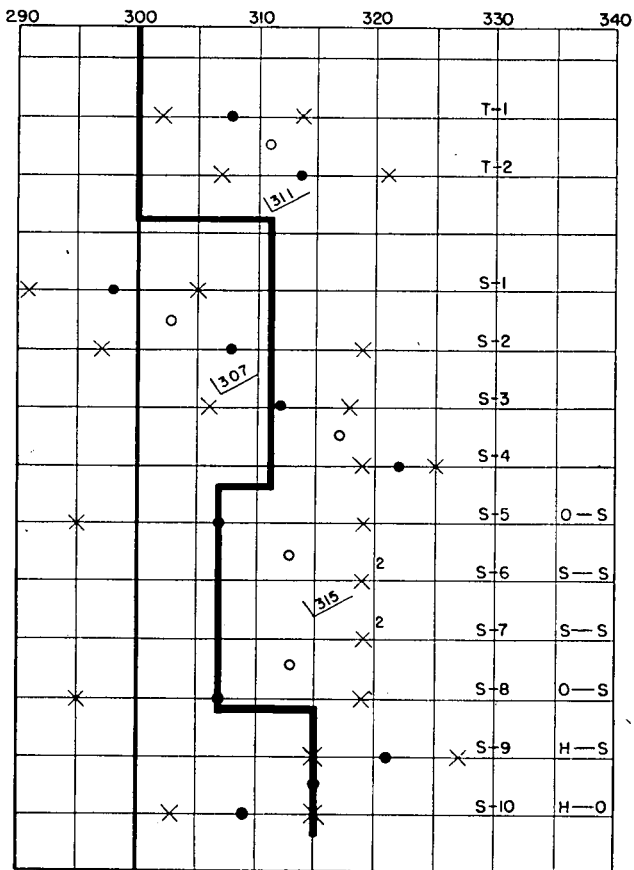

Figure 45. Fire adjustment chart (magnitude method), example 2, paragraph 120.

Section III. BRACKETING METHOD OF RANGE ADJUSTMENT

121. GENERAL. When only the sense of the range deviations can be obtained, the bracketing method of adjustment is used. It is the standard method of adjustment for rapid-fire batteries and an alternate method for larger caliber guns when adjustment by magnitude is impossible. Corrections are based on the relative number of overs and shorts. Sensings are normally obtained by an axial spotter.

122. TRIAL FIRE. a. The normal method of firing trial fire is by individually ordered battery salvos. Trial fire is continued until the target is straddled in a single salvo or is inclosed in a one-fork bracket by two salvos. The rules given below offer the greatest probability of quick adjustment.

b. Rules. Trial fire opens with the firing of one salvo.

(1) If the impacts of this salvo are sensed—

4-shot salvo	3-shot salvo	2-shot salvo
All in the same sense.	All in the same sense.	All in the same sense.

an adjustment correction of one fork is applied and such correction repeated after each salvo until two corrections differing by one fork are determined, one of which gives overs and the other shorts. Fire for effect is started with that correction which is the mean of the corrections giving the bracket; that is, the correction that "splits the bracket." If, however, in attempting to obtain a bracket, any salvo gives a straddle, the correction with which to enter fire for effect should be obtained in the manner that applies, as indicated in (2) or (3) following.

(2) If the impacts are sensed—

4-shot salvo	3-shot salvo	2-shot salvo
3 overs and 1 short or 3 shorts and 1 over.	1 hit and 2 overs or 1 hit and 2 shorts.	
1 hit and 3 overs or 1 hit and 3 shorts.		

an adjustment correction of one probable error is applied in the proper direction. This is the correction with which to enter fire for effect.

(3) If the impacts are sensed—

4-shot salvo	3-shot salvo	2-shot salvo
2 overs and 2 shorts..	1 hit, 1 over, and 1 short.	1 over and 1 short.
1 hit as well as 1 or more overs and 1 or more shorts.	2 or more hits.....	1 or more hits.
2 or more hits.....	2 overs and 1 short or 2 shorts and 1 over.	

no change is made; the correction with which this salvo was fired is the correction with which to enter fire for effect, and the shots of this salvo are plotted on the adjustment chart. (See fig. 46.)

123. FIRE FOR EFFECT. a. Corrections during this phase are determined by the formula:

$$\text{Correction} = \frac{\text{Overs} - \text{shorts (or shorts} - \text{overs)}}{2 \times (\text{overs} + \text{shorts})} \times 1 \text{ fork}$$

in which a hit is counted as both an over and a short. To facilitate the determination of corrections from the formula, the bracketing adjustment chart is constructed. (See FM 4-15.)

b. Firing is continuous, and all shots are plotted on the chart as described in FM 4-15. Overs are plotted horizontally, shorts vertically, and hits diagonally.

c. In general, corrections are based on not fewer than eight shots and not more than twelve. However, if fire for effect is started with a correction that is the mean of the corrections that gave a bracket (see par. 122b), and *if the first four impacts of fire for effect* are all in the same sense, a correction of one-half fork should be applied immediately.

d. Since the bracketing adjustment chart provides no means for stripping out corrections, only shots that have been fired with the same adjustment correction can be considered together. As soon as a new correction is ordered and takes effect on the fall of shots, a new chart must be started.

e. In general, not more than twelve shots are plotted on one chart in determining a correction. If no correction is made after twelve shots have been plotted, a new chart is started. After the first four shots have been plotted on the new chart, the last four of the previous graph are "plotted mentally" after the first four just mentioned; that is, the adjuster mentally lifts the pattern of the last four shots from the previous graph and attaches it to the pattern of the first four shots on the new graph. A correction is considered on the basis of these eight shots. If a correction is indicated, it is the correction read at the end of the "mental plot." However, the circle is placed at the point of the fourth shot of the actual plot, and the magnitude of the correction from the point of the "mental plot" is written within this circle. If no correction is indicated at the end of the "mental plot," the pattern of the four actual shots is extended without a break until it is influenced by a correction at the eighth or twelfth shot or by the

necessity of starting another new chart. (See example 2 following.)

f. Shots fired after a correction has been ordered, but before the correction has affected the fall of shots, are plotted on the old chart.

g. These rules apply to batteries firing with 2-gun salvos as well as with 4-gun salvos. For 3-gun salvos the rules must obviously be modified slightly.

NOTE. When adjustment is based on deviations sensed from an axial station, all sensings must be treated with great caution until some portion of the splashes of shots is in line with some portion of the target. In some cases, therefore, it may be necessary to withhold range adjustment until after an initial lateral adjustment has taken effect.

h. Example 1. The assumed situation is as follows:

Armament.....	Four 155-mm guns
Time of flight.....	18 seconds
Firing interval.....	15 seconds
Time required for spotting and applying adjustment correc- tions.....	10 seconds
Data to guns before firing.....	15 seconds
Assumed probable error.....	0.5 percent

In this situation, two salvos were fired in the fire for effect phase before a correction ordered could take effect. The first salvo was spotted as all overs, so a down correction of one fork was ordered, giving a net correction of 280. The second salvo was similarly spotted as all overs, and a second correction of down one fork was ordered, giving a net correction of 260. All shots of the third salvo were short, and a correction of up one-half fork was ordered, resulting in a correction of 270. Fire for effect was begun with this correction. The first salvo of fire for effect was sensed as all shorts, and when plotted this showed a correction of up 10 to 280. (This is in accordance with the rule which states: If fire for effect is started

with a correction that is the mean of the corrections that gave a bracket, and if the first four impacts of fire for effect are all in the same sense, a correction of one-half fork should be applied immediately. In this case 270 represents the mean between 280, which gave overs, and 260, which gave shorts.) The next two salvos, both spotted as all shorts, were fired before the correction could take effect, and they were accordingly plotted on the first chart. A new chart was started, and the next two salvos gave a correction of down 5 to 275. Two more salvos were plotted on the second chart, since they were both fired before the correction of 275 could take effect. A tabulation of the example follows. The symbol T-1 means "trial salvo 1," and S-1 means "fire for effect salvo 1."

Salvo No.	Adjustment correction with which fired	Sensings	Adjustment correction ordered
T-1	300	O-O-O-O	280
T-2	280	O-O-O-O	260
T-3	260	S-S-S-S	270
S-1	270	S-S-S-S	280
S-2	270	S-S-S-S	
S-3	270	S-S-S-S	
S-4	280	O-O-S-O	
S-5	280	O-O-O-S	275
S-6	280	O-S-O-O	
S-7	280	S-O-O-O	

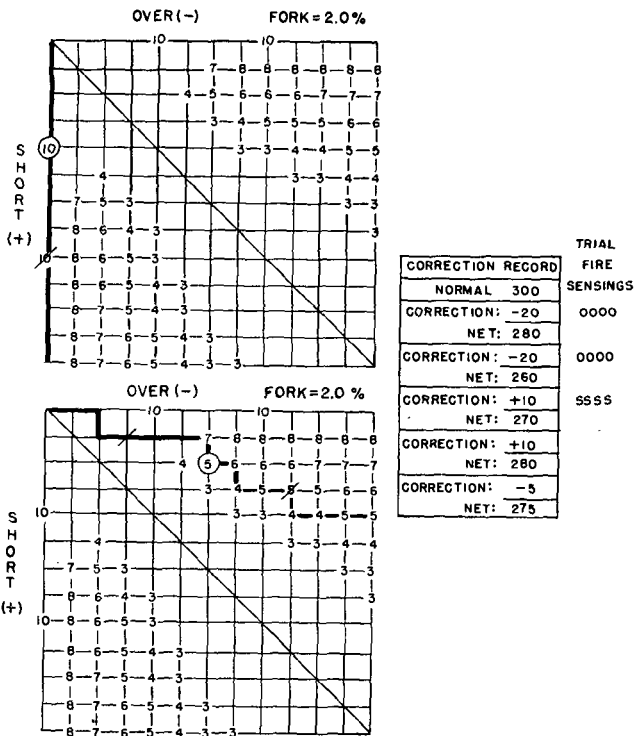

Figure 46. Fire adjustment chart (bracketing method), example 1, paragraph 123.

i. Example 2. The situation is similar to that of the previous example. A trial salvo was fired and spotted as three shorts and one over. The appropriate correction of up one probable error, or 305, was ordered, and fire for effect was commenced. No correction was found necessary after the third salvo of fire for effect, and a new chart was started. The fourth salvo was plotted as short-short-hit-short, and in accordance with the rule shown in e above, the third salvo on the old chart was replotted mentally after the first salvo on the new chart. (As a visual aid, this is shown by a dotted line in fig. 47.) This gave a correction of up 6, or 311. The value of +6 was written in the circle which was placed at the end of the fourth salvo. The tabulation follows:

Salvo No.	Adjustment correction with which fired	Sensings	Adjustment correction ordered
T-1	300	S-S-O-S	305
S-1	305	O-O-H-S	
S-2	305	S-O-S-S	
S-3	305	O-S-S-S	
S-4	305	S-S-H-S	311
S-5	305	S-S-S-H	
S-6	305	S-O-S-S	

j. **Example 3.** The situation was similar to that of the previous example, except that the probable error in this example is 0.6 percent, and only one salvo was fired in the fire for effect phase before a correction ordered could take effect. The trial salvo was spotted as two shorts and two overs. No correction was ordered, and the salvo was plotted on the chart. (See par. 122b(2).) The next salvo gave four overs, and the indicated correction of down 6, or 294, was ordered. Even though the first salvo was a trial salvo, it could be used with the second salvo in determining a correction because both were fired with the correction of 300. The next salvo, fired before the correction of 294 could be applied, was plotted on the first chart. The next salvos, S-3, S-4, and S-5 in the tabulation, were plotted on a new chart, and gave a correction of up 4, or 298, based on 12 shots. The tabulation follows:

Salvo No.	Adjustment correction with which fired	Sensings	Adjustment correction ordered
T-1	300	O-O-S-S	
S-1	300	O-O-O-O	294
S-2	300	S-O-O-O	
S-3	294	S-S-O-S	
S-4	294	O-H-S-H	
S-5	294	S-S-H-S	298
S-6	294	O-S-O-H	

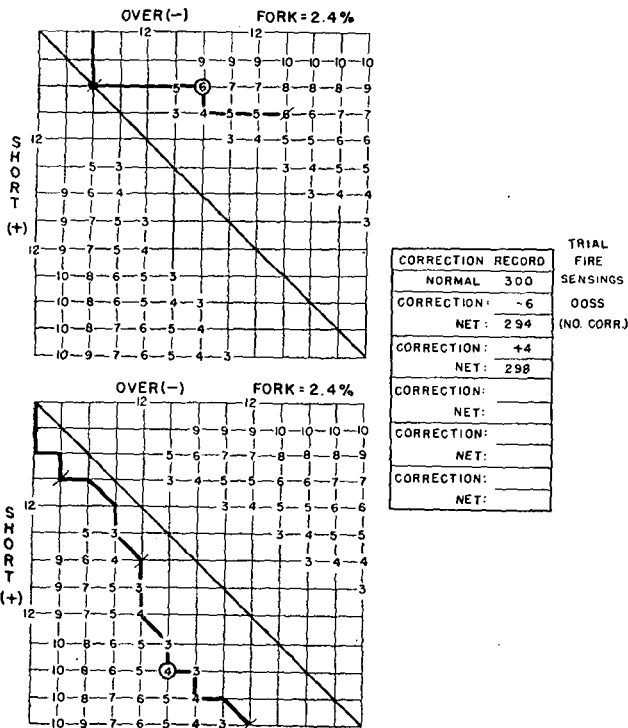

Figure 48. Fire adjustment chart (bracketing method), example 3, paragraph 123.

Section IV. LATERAL ADJUSTMENT

124. GENERAL. A bow-on target offers a battery a good chance of obtaining hits in range, but at the same time presents a small hitting area laterally. Therefore, if the center of impact is but slightly off the target laterally, the opportunity of doing damage to the target is lost. Since this is true,

lateral adjustment must be conducted with great care and accuracy. The adjuster must be prepared to make corrections at any time and on very few shots. He should expect to base corrections on as few as four shots and at all times should consider the last salvos only.

a. Adjustment in direction is based on measured lateral deviations. The deviations may be obtained either from a spotting board or from an azimuth instrument. The most desirable method is the use of an azimuth instrument located near the gun-target line.

b. Lateral dispersion is usually quite small but should be considered in adjustment. Since the dispersion is small, however, one or two impacts, with accurate gun pointing and position finding, will give a good indication of the center of impact and permit a full correction to be made.

c. As in range adjustment, trifling corrections are to be avoided. Whether or not a correction is warranted is a matter of judgment, depending in part on the amount of lateral dispersion to be expected. Corrections of less than one probable error normally are not warranted.

d. Corrections, when made, should be determined and applied to the nearest 1/100th degree or 1 mil, if possible, or as accurately as the pointing equipment permits.

e. Lateral corrections are best applied as flat angular corrections. The linear effect of such corrections will vary in proportion to the range.

125. METHOD OF ADJUSTMENT. a. Spotting.

The observer near the gun-target line measures the deviation of the splashes. Each splash is measured from the position of the target when that splash occurs. If two or more splashes occur at the same time, the center of impact may be spotted. At long ranges, the spotting board may be the only source of information concerning lateral deviations.

b. Corrections in direction should be applied to the deflection board for the battery as a whole. If preparation of fire has been careful and accurate, the guns will shoot together. The suggested procedure is to apply corrections to the deflection board based on the center of impact of the splashes.

c. The plotting of impacts in lateral adjustment is done on cross-section paper mounted on the fire adjustment board M1, and is similar to the magnitude method of range adjustment. Single impacts have no exponents. Centers of impact of several shots falling simultaneously have an exponent indicating the number of shots. The correction scale on the adjustment board must be graduated in the same manner as the adjustment scale on the deflection board or the azimuth spot dial on the gun data computer. The plotting scale or ruler must conform to the units in which lateral deviations are being received. (See FM 4-15.)

d. The battery corrections (which apply to all guns), resulting from the plotting of the deviations, are read from the adjustment board. Note that the target line does not change until the correction takes effect.

e. **Individual gun corrections.** With proper preparation the guns of the battery will shoot together. Personnel errors or malfunctions of sighting or pointing equipment may cause the guns to shoot apart. Corrective action to bring the guns together may be required if it is found that the error is systematic. This is likely only with mobile guns using panoramic telescopes, in which case the closing correction can be applied directly to the telescope. Fixed guns, properly calibrated, will not shoot apart in any consistent manner and, therefore, the error ordinarily will not be systematic. Errors that occur will ordinarily be accidental errors. As these errors will vary, no effort should be made to correct them through fire adjustment. If they continue, firing must be stopped

(if firing target practice) until the cause of the errors has been determined and the fault corrected. It is important to guard against applying a correction to take care of an error made on one shot by a gun pointer or by a slippage in some part of the mechanism, since it is unlikely that the same error will be made on succeeding shots.

126. JUMPING SPLASHES. a. When no other means of adjustment is available, the gun pointers may be required to adjust individually by the method known as jumping splashes. It is used in case II pointing as an alternate method only.

b. After the gun is fired, the gun pointer continues tracking the target by traversing the gun until the splash occurs. Then he stops traversing the gun and turns the line of sight of the telescope to the splash. He then resumes tracking by traversing the gun until the line of sight is once more on the target. It will be seen that if the splash occurs to the right of the target, the sight will have to be turned to the right. This will cause the gun to be pointed farther to the left when the target is again tracked. This method is useful chiefly for rapid-fire guns firing at short range when the time of flight will probably be less than the firing interval.

c. There are several difficulties to this method. First, the gun pointer is kept busy enough with the single task of tracking the target. Second, he will have difficulty in isolating the splashes of his gun from those of the other guns of the battery. Furthermore, the problem of timing (coordinating the splash with the shot which caused it, and determining when a correction has taken effect) is very difficult to cope with under the stress of firing conditions. Finally, weather conditions and the smoke of firing may make this method of adjustment impossible. *It should never be used if other methods of adjustment are available.*

127. PROBLEMS IN LATERAL ADJUSTMENT.

a. Example 1. The situation is as follows:

Armament.....	Four 155-mm guns
Spotting instrument.....	Azimuth instrument M1910A1
Deflection board.....	M1, with correction scale in degrees, 3.00 normal
Lateral probable error....	0.02°

The time of flight was such that in fire for effect two salvos were fired before a correction ordered could be applied. It will be noted that in most cases the spotter was unable to read every splash. He was trained to read all he could, to take centers of impact at other times, and to indicate how many splashes were considered. (The number of salvos of trial fire is a function of range adjustment; however, the lateral adjuster should take advantage of the delay to apply further adjustment corrections.) The impacts of the first salvo gave a correction, based on the center of impact, of 310. The correction was applied to the second trial salvo. The readings from the second salvo showed three shots at 306 and one at 302. Looking again at the first salvo; the adjuster noted that two of the shots were paired close to 315, while the other two were spread apart considerably. For this reason he felt that a full correction on the second salvo was justified. There seemed to be little choice between a correction of 315 and 316, but he ordered 315 because it was easier to set on the deflection board. On the first salvo of fire for effect, the center of impact of three shots was on the target and the fourth fell at 316. With such a grouping of shots, the 316 was obviously a wild shot and was consequently ignored. The center of impact of salvos two, three, and four of fire for effect was on the target. Salvo four had three shots at 306 and one at 302. Although this deviation was actually in excess of the probable error of the battery, the adjuster felt that it might have

been caused by some accidental error in the position finding system and decided to wait for confirmation. This was further justified by the fact that the three previous salvos had all fallen so close to the target. When the fifth fell with three shots at 304 and one at 306, he ordered a correction of 320 (read from the top of the chart). This took effect on the fall of shots at the eighth salvo. A tabulation of the firing follows:

Salvo No.	Adjustment correction with which fired	Point of impact	Adjustment correction ordered
T-1	300	314, 308, 316, 304	310
T-2	310	306 (3 shots), 302	315
S-1	315	300 (3 shots), 316	
S-2	315	299, 302 (3 shots)	
S-3	315	299 (2 shots), 297, 304	
S-4	315	306 (3 shots), 302	
S-5	315	304 (3 shots), 306	320
S-6	315	306 (4 shots)	
S-7	315	304 (2 shots) 306 (2 shots)	
S-8	320	302 (2 shots) 298 (2 shots)	Correction 320 applied

P.E. = 0.02°

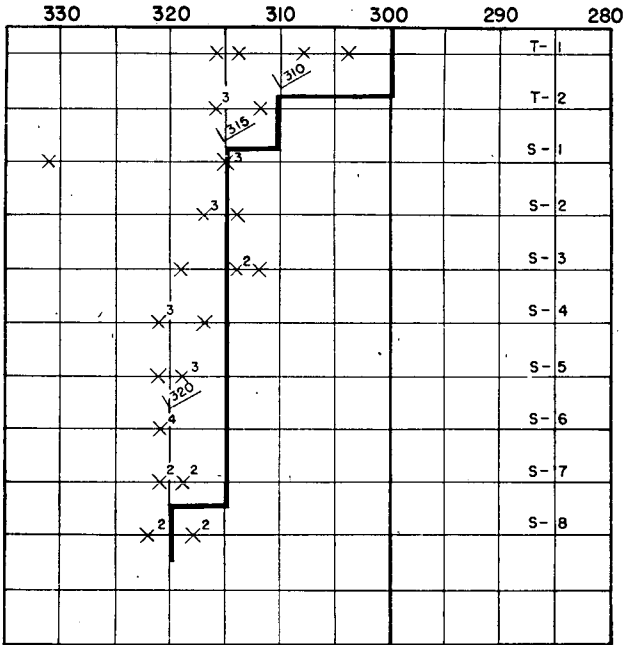

Figure 49. Lateral adjustment chart, example 1, paragraph 127.

b. Example 2. The situation is as follows:

- Armament..... Two 155-mm guns
- Spotting..... Azimuth instrument
M1910A1
- Deflection board..... M1 with correction scale in
degrees, 3.00 normal
- Sighting equipment..... Panoramic telescope M8
- Lateral probable error.... 0.02°

The time of flight is such that in fire for effect two salvos were fired before a correction ordered could be applied. The first trial salvo was spotted 290 and 282. A correction for the center of impact,

286, was ordered and immediately took effect. The second salvo, also a trial salvo, was spotted at 308 and 296. After the first salvo of fire for effect, the spotter reported that although the center of impact was on the target, neither gun was on the target laterally and the guns appeared to be spread by about 0.10° . The firing of the guns was immediately staggered (the interval between shots should be 2 seconds) to determine if this spread was a systematic error which might be corrected. From the fall of the third and fourth salvos of fire for

Salvo No.	Adjustment correction with which fired	Spotted deviations	Adjustment correction ordered
T-1	300	290, 282	286
T-2	286	308, 296	
S-1	286	296, 304	
S-2	286	296, 306	
S-3	286	297 (1)* 305 (2)*	The first staggered salvo
S-4	286	296 (1) 304 (2)	Battery corr. 282, gun No. 2, right 0.10°
S-5	286	295 (1) 306 (2)	
S-6	286	295 (1) 303 (2)	
S-7	282	301 (1) 299 (2)	Corrections 282 and right 0.10° take effect
S-8	282	298, 299	Guns again fire together

*Numbers in parentheses in table and subscripts in figure 50 refer to the number of the gun with which shots were fired.

Section V. ADJUSTMENT OF SIMULATED FIRE

128. GENERAL. Opportunities to practice adjustment of fire during actual firing are comparatively rare. The only way to become thoroughly familiar with the principles and rules governing fire adjustment is by regular and frequent training in their application. A satisfactory means of securing this training is by simulating fire and using the dispersion box. In using this device the problem should be made as realistic as possible. It may readily be used at battery drill with the normal fire control system.

129. THE DISPERSION BOX. a. Dispersion tape.

The dispersion tape is a roll of paper divided into several hundred frames on each of which are placed four vertical marks to represent splashes. The center of the tape represents the center of dispersion. Four vertical marks are positioned in each frame according to laws of dispersion. For proper identification of shots in simulated salvo firing, three of the four marks bear different symbols. One bears a cross, another a circle, a third a double bar, and the fourth is plain. The tape is mounted on rollers in the box and is covered so that only one frame is visible at a time. (Dispersion tapes and plans for constructing the box may be obtained, upon request, from the Coast Artillery Board.)

b. Deviation scale (fig. 51). (1) This is a movable scale placed in a guide under the window of the dispersion box and graduated with the standard range reference numbers representing percentages of range. The graduations increase from left to right, with the midpoint, marked 300, representing the position of the target. The scale of the graduations should be such as to fit the dispersion zone of the dispersion tape and the probable error of the armament manned. It must be

made locally by each battery. The depth of the dispersion zone on the tape issued by the Coast Artillery Board is 6.8 inches representing 8 P.E. or two forks. The scale of graduations may be determined from this relationship. For example, if the probable error in range for the armament is 0.6 percent, the scale of the graduations should be:

$$1 \text{ percent} = \frac{6.8}{8 \times 0.6} = 1.42 \text{ inches}$$

(2) An auxiliary deviation scale marked *over*, *short*, and *hit* can be made for use with the bracketing method of adjustment. The width of the space marked *hit* on the deviation scale may be determined from the size of the danger space of the average target at medium range. (See table VII, TM 4-235.)

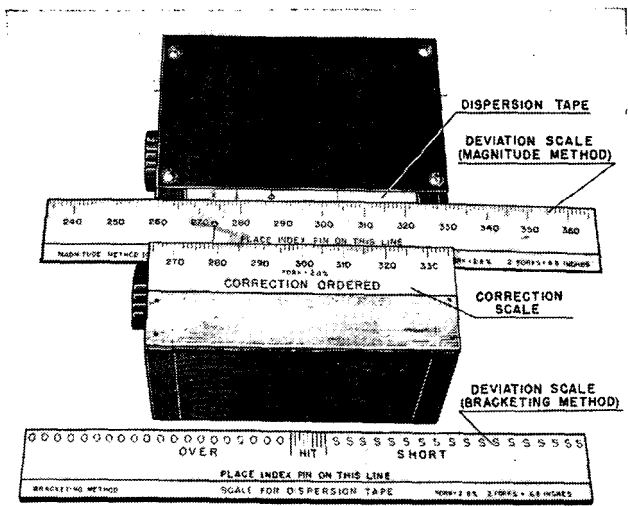

Figure 51. Dispersion box.

c. **Correction scale.** The correction scale is identical with the deviation scale. It is fixed to the box with its normal (300) opposite the center of the dispersion tape.

130. INSTRUCTIONS FOR USE. a. The operator determines deviations by reading from the scale opposite the marks on the tape. He reads as many deviations from a frame as are needed for the salvo and moves the tape a predetermined number of frames to get the next set of deviations. A great number of combinations of deviations may be secured by changing the selection of marks to be read or the number of frames to be turned between readings. The tape may be turned in either direction. The only precaution necessary is that the selection of frames and marks be made by some predetermined rule which should be followed until the end of the problem in order to insure that the dispersion depends on chance.

b. Proper simulation of timing is one of the most important and, at the same time, most difficult elements of successful drill. Except for such preliminary instructions as may be necessary, all problems should be conducted with the same timing as would be required during firing. No deviation should be reported to the person conducting the adjustment until the end of the period required for the time of flight and the normal functioning of the spotting section. Corrections should not be applied to the firing data sooner than could be done normally.

c. Care should be taken to keep the position of the deviation scale in step with the firing data. An adjustment correction should not be applied on the dispersion box until the fall of the shot fired with that correction occurs.

131. OPERATION IN DRILL. a. Place a pin at any desired position on the deviation scale. Insert the deviation scale in its slot with the pin opposite 300 on the correction scale.

b. Determine a rule to be followed in selecting deviations on the tape and the number of frames to be moved. Following that rule, bring the proper frame of the dispersion tape into view in the window of the box.

c. At the proper time, read the deviation from the deviation scale opposite the mark that represents the splash.

d. Turn the tape to a new frame.

e. When an adjustment correction is ordered, move the deviation scale until the pin is opposite that correction on the correction scale, timing the move to synchronize with the fall of the shots on which the new correction is applied. Proper adjustment is reached when the 300 of the deviation scale is opposite the 300 of the correction scale.

132. USE WITH THE SPOTTING BOARD. The dispersion box may also be used with the spotting board to determine simulated data to furnish to the spotters for battery drill. Deviations taken from the dispersion box are plotted on the grid of the spotting board; the deviation arms are set so that they intersect on the grid at these deviations; and the readings on the deviation disks are recorded. During drill these readings are transmitted from the spotting stations to the spotting board and will provide properly dispersed deviations for the spotting and adjusting details. In this way the spotters and adjusters can be coordinated with the rest of the battery.

APPENDIX I

GLOSSARY

Backlash. The lost motion or play in the gears of a mechanical system.

Ballistic conditions. Conditions which affect the motion of projectiles in the bore and through the atmosphere. Among these conditions may be included muzzle velocity, weight of projectile, size and shape of projectile, wind, rotation of projectile, rotation of earth, density of the air, and temperature of the air.

Check point. A point in the field of fire for which data are computed mathematically for the purpose of checking fire control equipment.

Coefficient of form. Factor introduced into ballistic coefficient to make its value conform to results determined by firing.

Conduct of fire. Employment of technical means to place accurate fire on target. Fire is usually conducted by the battery, which is the normal fire unit.

Data line. Telephone line used for transmission of data. See *intelligence line*.

Hitting area. Arbitrarily defined as area extending three probable errors in range and direction on each side of center of dispersion.

Intelligence line. Telephone line used for transmission of messages as distinguished from data. See *data line*.

See "Glossary," FM 4-15, for additional definitions pertaining to gunnery.

Lateral adjustment correction. That correction determined from actual firing which places center of impact on target in direction.

Line of collimation. Line from center of objective lens of telescope through and perpendicular to the axis of vertical rotation.

Map range. Range from the piece to any point as scaled or computed from a map.

Meteorological datum plane. Reference plane for data furnished to artillery concerning atmospheric conditions. Its altitude is that of meteorological station.

Normal of scale. Reference number which represents zero units of value on scale concerned.

Orientation. a. Determination of horizontal and vertical location of points and establishment of orienting lines. b. Adjustment of azimuth circle of gun or of instrument to read correct azimuths.

Pintle center. Vertical axis about which a gun and its carriage are traversed.

Probability factor. Factor used as an argument in entering probability tables. It is equal to error not to be exceeded divided by probable error.

Uncorrected deflection. Deflection due to travel of target during time of flight.

APPENDIX II

EFFECTS OF SMALL ERRORS WHEN USING HORIZONTAL BASE POSITION FINDING OR TWO-STATION SPOTTING SYSTEM

Section I. HORIZONTAL BASE SYSTEM

1. EFFECTS OF SMALL CHANGES IN OBSERVED AZIMUTHS. a. It is sometimes desirable to know the effect, particularly in range, produced by small changes in the azimuths measured at the base-end stations; that is, the effect

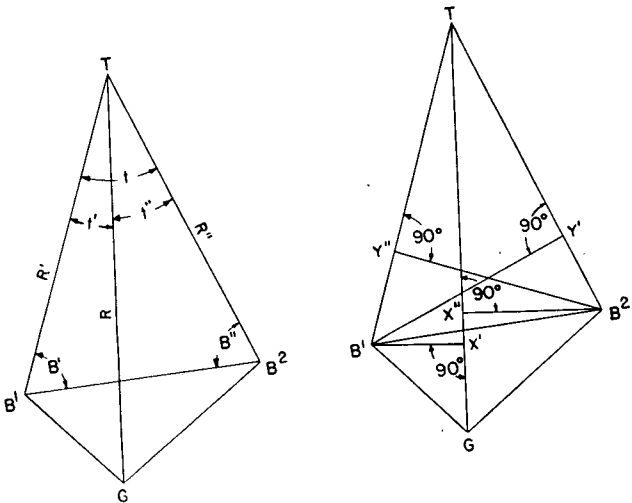

Figure 52. Effect of small changes in observed azimuths, horizontal base.

of errors in reading the azimuth of a target. The equations given below have been derived by differential calculus for this purpose. Their similarity to the equations for range and lateral deviations used in spotting will be noted. (See ch. 8.)

$$\Delta R \text{ (in yards)} = \pm \frac{R' \cos t''}{\sin t} \Delta B' \pm \frac{R'' \cos t'}{\sin t} \Delta B'' \quad (1)$$

$$\Delta L \text{ (in yards)} = \pm \frac{R' \sin t''}{\sin t} \Delta B' \pm \frac{R'' \sin t'}{\sin t} \Delta B'' \quad (2)$$

In these equations, ΔR and ΔL are the effects in range and direction, respectively, from G of figure 52 due to the small changes in azimuth $\Delta B'$ and $\Delta B''$ from the observing stations B^1 and B^2 , respectively. $\Delta B'$ and $\Delta B''$ must be in radians. If they are expressed in degrees, multiply by 0.01745.

The remaining terms of the equations are illustrated in figure 52. The signs of the right-hand terms depend on the direction in which the error $\Delta B'$ or $\Delta B''$ is made and must be determined by inspection. In the figure, an error to the right at B^1 gives a negative sign because its effect on the range is negative. By similar reasoning, an error to the right at B^2 gives a positive sign. The values for substitution in the equations may be read from a small scale plot of the situation; a scale of 1,000 yards to the inch should be suitable. The only precaution to be noted pertains to the measurement of the small angles t , t' , and t'' . Whenever the sines of these angles are used, the angles must be measured carefully to avoid large errors. If it is possible to determine the values of these angles by taking azimuth difference, these values should be taken in preference to values measured from the plot. Equations (1) and (2) may be expressed entirely in linear values as follows, in which case measurement of the angles is avoided (fig. 52):

$$\Delta R = \pm \frac{(R') (TX'')}{B^2 Y''} \Delta B' \pm \frac{(R'') (TX')}{B^1 Y'} \Delta B'' \quad (3)$$

$$\Delta L = \pm \frac{(R') (B''X'')}{B^2Y''} \Delta B' \pm \frac{(R'') (B'X')}{B^1Y'} \Delta B'' \quad (4)$$

b. For convenience, let the letters M and N represent the coefficients of $\Delta B'$ and $\Delta B''$, respectively. Then—

$$M_R = \frac{R' \cos t''}{\sin t} = \frac{(R') (TX'')}{B^2Y''}$$

$$M_L = \frac{R' \sin t''}{\sin t} = \frac{(R') (B''X'')}{B^2Y''}$$

$$N_R = \frac{R'' \cos t'}{\sin t} = \frac{(R'') (TX')}{B^1Y'}$$

$$N_L = \frac{R'' \sin t'}{\sin t} = \frac{(R'') (B'X')}{B^1Y'}$$

and

$$\Delta R = \pm M_R \Delta B' \pm N_R \Delta B''$$

$$\Delta L = \pm M_L \Delta B' \pm N_L \Delta B''$$

The positions of B^1 , B^2 , and G being fixed, then to each point T in the field of fire there corresponds a definite value of M and a definite value of N . An error of $\Delta B'$ in the measurement of the B^1 azimuth accompanied by a zero error in the measurement of the B^2 azimuth will result in an error of $M_R \Delta B'$ in the determination of the range, and of $M_L \Delta B'$ in the determination of the azimuth from the directing point to the target. The errors made at the two stations are independent of each other. If an error is made at each station, their results must be added algebraically (a above) to find their combined effect.

2. PROBABLE ERROR. a. The errors made by the base-end observers may be considered to be normally distributed, that is, according to the curve of accidental errors. In artillery practice, the probable error r' of an observer in reading azimuths is taken as the product of his mean error times the factor 0.845. The corresponding probable

error in range is equal to the probable error in azimuth times the factor M_R (or N_R). The probable error in direction may be found by a similar combination.

b. Since the errors at the two stations are normally distributed and independent of each other and since their results must be added algebraically to find their combined error, the combined result of the corresponding probable errors may be found by compounding those probable errors as follows:

The total range probable error

$$r_R = \sqrt{(M_R r')^2 + (N_R r'')^2}$$

The total lateral probable error

$$r_L = \sqrt{(M_L r')^2 + (N_L r'')^2}$$

NOTE. A more complete discussion of probable errors is found in chapter 6.

3. EXAMPLES. a. Assume that the values in figure 52 are as follows:

$$\begin{array}{ll} t' = 1^\circ 45' & R' = 15,000 \text{ yards} \\ t'' = 9^\circ 30' & R'' = 18,000 \text{ yards} \\ t = 11^\circ 15' & \end{array}$$

Find the change in range corresponding to an error of 0.25° in the B^1 azimuth alone.

Solution:

$$M_R = \frac{15,000 \cos 9^\circ 30'}{\sin 11^\circ 15'}; \Delta B' = 0.25 \times 0.01745$$

$$\begin{array}{r} \log 15,000 = 4.17609 \\ \log \cos 9^\circ 30' = 9.99400 - 10 \\ \text{colog } \sin 11^\circ 15' = 0.70976 \\ \hline \log M_R = 4.87985 \\ M_R = 75,832 \\ \log 0.25 = 9.39794 - 10 \\ \log 0.01745 = 8.24180 - 10 \\ \hline \log \Delta B' = 7.63974 - 10 \\ \Delta B' = 0.004362 \text{ radian} \\ \Delta R = M_R \Delta B' = 75,833 \times 0.004362 \\ \log 75,832 = 4.87985 \\ \log 0.004362 = 7.63974 - 10 \\ \hline \log \Delta R = 2.51959 \\ \Delta R = 331 \text{ yards} \end{array}$$

b. In the same situation, find the change in range corresponding to an error of 0.25° in the B^2 azimuth alone.

Solution:

$$N_R = \frac{18,000 \cos 1^\circ 45'}{\sin 11^\circ 15'}$$

$$\begin{aligned} \log 18,000 &= 4.25527 \\ \log \cos 1^\circ 45' &= 9.99980 - 10 \\ \text{colog } \sin 11^\circ 15' &= 0.70976 \\ \hline \log N_R &= 4.96483 \\ N_R &= 92,220 \\ \Delta B'' = \Delta B' &= 0.004362 \text{ radian} \\ \Delta R = N_R \Delta B'' &= 92,220 \times 0.004362 \\ \log 92,220 &= 4.96483 \\ \log 0.004362 &= 7.63974 - 10 \\ \hline \log \Delta R &= 2.60457 \\ \Delta R &= 402 \text{ yards} \end{aligned}$$

c. Recent experiments indicate that the probable error to be expected of an experienced enlisted observer using an accurately oriented D.P.F. or an azimuth instrument is about 0.005° . Applying this value to the situation in a above, find the probable error in range finding so far as the measurement of base-end azimuths is concerned.

Solution:

$$\begin{aligned} r_R &= \sqrt{(M_{Rr'})^2 + (N_{Rr''})^2} \\ M_R &= 75,832 \\ N_R &= 92,220 \\ r' = r'' &= 0.005 \times 0.01745 \text{ radian} = 0.00008725 \text{ radian} \end{aligned}$$

By slide rule:

$$\begin{aligned} (M_{Rr'})^2 &= 43.8 \\ (N_{Rr''})^2 &= 64.7 \\ (r_R)^2 &= 108.5 \text{ yards} \\ r_R &= 10 \text{ yards} \end{aligned}$$

d. The equation given above shows the probable error in range finding due to errors in measurement of azimuth alone and does not touch the problem of errors made in plotting these azimuths on the plotting board. The latter will depend upon the geometrical figure just as in the preceding dis-

cussion, and in addition it will depend upon the type of board, its mechanical condition, and the scale of plotting. If the probable error in indicated range due to operation of the plotting board becomes known, this value may be compounded with r_R of the preceding discussion by the rule of the square root of the sum of the squares. For example, assume that the probable error of the plotting board is equal to that of the observation as calculated in c above, and find the total probable error in range finding.

Solution:

$$\begin{aligned} r_R &= \sqrt{(31)^2 + (31)^2} = 31 \times \sqrt{2} \\ &= 31 \times 1.41 = 43 \text{ yards} \end{aligned}$$

Note that this deals only with the accidental errors and not with the systematic errors, so that this value shows the magnitude of the irregularities to be expected in the plotted course.

Section II. TWO-STATION SPOTTING SYSTEM

4. ERRORS. Denoting the true values of the angular deviations of a splash from the target by $\Delta S'$ and $\Delta S''$ and the errors of the spotters in measuring those angles $\delta S'$ and $\delta S''$, and using the values of M_R and N_R as given in paragraph 1b, the indicated value of the range deviation would be

$$\begin{aligned} \Delta R' &= M_R(\Delta S' + \delta S') + N_R(\Delta S'' + \delta S'') \\ &= (M_R \Delta S' + N_R \Delta S'') + (M_R \delta S' + N_R \delta S'') \end{aligned}$$

While the true value of the deviation would be

$$\Delta R = M_R \Delta S' + N_R \Delta S''$$

The error in spotting, δR , would be

$$\delta R = \Delta R' - \Delta R = M_R \delta S' + N_R \delta S''$$

5. EXAMPLE. Given the values $t' = 50$ mils, $t'' = 230$ mils, $t = 280$ mils, $R' = 14,800$ yards, and $R'' = 15,200$ yards. What range spotting error cor-

responds to an angular error of 1 mil at each station if both errors are in the same sense?

Solution:

$$\delta R = M_R \delta S' + N_R \delta S''$$

$$\delta S' = \delta S'' = 1 \text{ mil} = 0.0009817 \text{ radian}$$

$$\begin{aligned} \log R' &= 4.17026 \\ \log \cos t'' &= 9.98883 - 10 \\ \text{colog } \sin t &= 0.56633 \\ \hline \log M_R &= 4.72542 \\ \log \delta S' \text{ (radians)} &= 6.99198 - 10 \\ \hline \log M_R \delta S' &= 1.71740 \\ M_R \delta S' &= 52.2 \text{ yards} \end{aligned}$$

$$\begin{aligned} \log R'' &= 4.18184 \\ \log \cos t' &= 9.99948 - 10 \\ \text{colog } \sin t &= 0.56633 \\ \hline \log N_R &= 4.74765 \\ \log \delta S'' \text{ (radians)} &= 6.99198 - 10 \\ \hline \log N_R \delta S'' &= 1.73963 \\ N_R \delta S'' &= 54.9 \end{aligned}$$

$$\begin{aligned} \delta R &= 52.2 + 54.9 \\ &= 107 \text{ yards} \end{aligned}$$

6. PROBABLE ERROR. When the probable errors of the spotting observers are known, the probable error of spotting results may be computed just as the probable error of range finding was computed in paragraph 2. For example, if the spotting observers are using the azimuth instrument M1918, the least reading of the interior splash scale is 5 mils and they must interpolate between these graduations. Under these conditions, it seems likely that the probable error (r' and r'') of the reading would be 1 mil. The range probable error of the spotting system, exclusive of errors incidental to the operation of the spotting board, can be determined by the following equation:

$$r_R = \sqrt{(M_R r')^2 + (N_R r'')^2}$$

Assume that M_R and N_R are the same as in paragraph 5.

Therefore since $r' = r'' = 1 \text{ mil} = 0.0009817 \text{ radian}$

$$\begin{aligned} M_{Rr'} &= M_{R\delta S'} \\ N_{R''} &= N_{RS''} \end{aligned}$$

Use logarithms determined in paragraph 5.

$$\begin{array}{ll} \log M_{Rr'} = 1.71740 & \log N_{Rr''} = 1.73963 \\ \log (M_{Rr'})^2 = 3.43480 & \log (N_{Rr''})^2 = 3.47926 \\ (M_{Rr'})^2 = 2721 & (N_{Rr''})^2 = 3015 \\ (N_{Rr'})^2 = 3015 & \\ (M_{Rr'})^2 + (N_{Rr'})^2 = \overline{5736} & \\ (r_R)^2 = 5736 & \\ \log (r_R)^2 = 3.75861 & \\ \log r_R = 1.87930 & \\ r_R = 76 \text{ yards} & \end{array}$$

APPENDIX III

PRINCIPLES OF VERTICAL BASE POSITION FINDING

Section I. THEORETICAL PRINCIPLES

1. CURVATURE OF THE EARTH. a. In vertical base position finding, the range to the target is determined by the general equation $\tan a = \text{height of instrument} \div \text{range}$, where a is the measured angle between the horizontal and a line from the instrument to the water line of the target. This determination is affected by curvature of the earth and atmospheric refraction and both effects must be corrected. The effects are illustrated in figure 53. MT represents the surface of the earth,

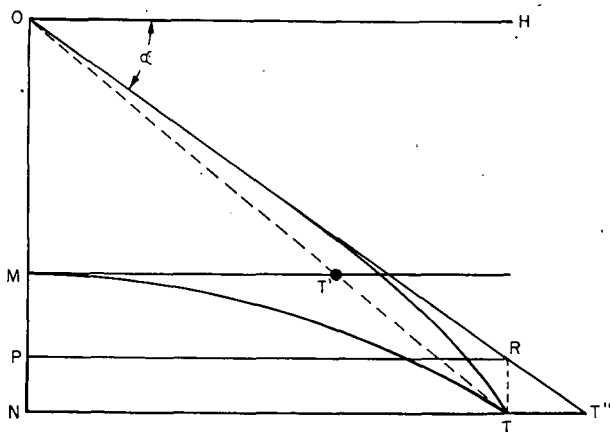

Figure 53. Effect of curvature and refraction.

T a target, and O an observing instrument with a height of instrument OM . If no refraction were present, the target would appear on the line OT and a true height of instrument OM would give a range MT' whereas the desired range is NT which differs by a negligible quantity from the map range. In order to correct for curvature of the earth, therefore, the height of instrument used in the computation must be increased by MN .

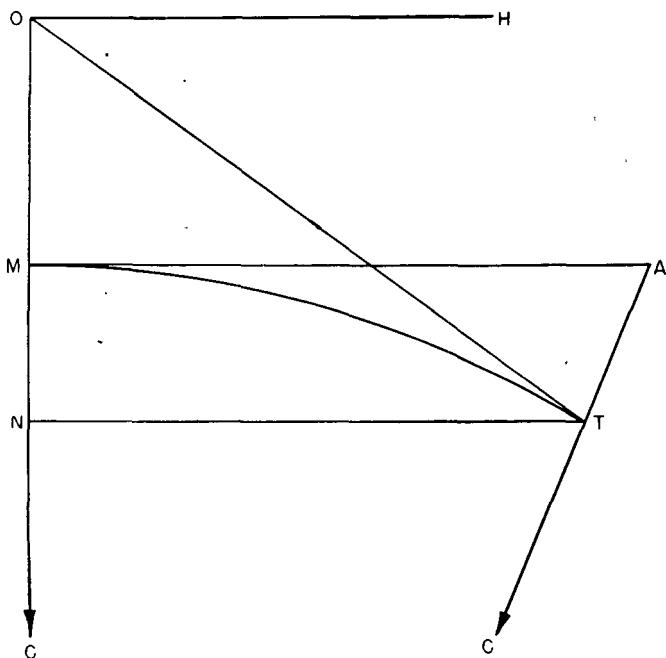

Figure 54. Magnitude of curvature effect.

b. The value of MN depends on the radius of curvature of the earth's surface and the range. In

figure 54, O , M , N , and T are shown as before, MA is a tangent, and C represents the center of the earth. From this figure—

$$\begin{aligned} AC^2 &= (AT+TC)^2 = AT^2 + 2AT \times TC + TC^2 \\ AC^2 &= MA^2 + MC^2 \\ \text{and } AT^2 + 2AT \times TC + TC^2 &= MA^2 + MC^2 \\ 2AT \times TC &= MA^2 + MC^2 - AT^2 - TC^2 \end{aligned}$$

Noting that $TC = MC$, then:

$$AT = \frac{MA^2}{2TC} - \frac{AT^2}{2TC}$$

But AT^2 is quite small and may be neglected.

$$\text{Hence } AT = \frac{MA^2}{2TC}$$

Let h_c represent the effect of curvature MN ($= AT$), R the range MT ($= MA$), and r the radius of the earth TC . The expression then becomes

$$h_c = \frac{R^2}{2r}$$

2. ATMOSPHERIC REFRACTION. The rays of light between an observer and a target are bent downward by refraction. As a result, the target in figure 53 will appear on the line ORT'' instead of OT . This would give a range NT'' whereas the desired range is still the range NT . Therefore the height of instrument used in the computation must be decreased by NP , giving a corrected height of instrument of OP . If the effect of refraction NP is represented by h_r ,

$$h_r = m \frac{R^2}{r}$$

where m is the coefficient of refraction.

A value of $m = .0714$ may be used in the calculation of firing data.

NOTE. A mean value of $r = 6,963,455$ yards has been used in the calculations of this appendix.

3. COMBINED EFFECT OF CURVATURE AND REFRACTION. Since, in seacoast artillery work, the effect of refraction is always to make the apparent effect of curvature less than the true value, the combined expression for curvature and refraction becomes

$$h = h_c - h_r = (1 - 2m) R^2 / 2r$$

Table I, appendix VI, gives the vertical effect of curvature and refraction combined for ranges between 1,000 and 50,000 yards.

4. RANGE FINDING BY THE DEPRESSION ANGLE. a. The range problem that is solved by a depression position finder is as follows (fig. 53):

$$\tan HOR = \tan ORP = (OM + MP) / PR$$

Let α represent the depression angle HOR ; b , the true height of instrument OM ; R , the range to the target PR ; and h , the combined vertical correction due to curvature and refraction MP . Then the equation may be written

$$\tan \alpha = (b + h) / R$$

Substituting for h its value $(1 - 2m) R^2 / 2r$

$$\tan \alpha = \frac{b}{R} + \frac{1 - 2m}{2r} R$$

Let $C = (1 - 2m) / 2r$

Then

$$\tan \alpha = \frac{b}{R} + CR$$

Solving for R , we get

$$R = \frac{\tan \alpha - \sqrt{\tan^2 \alpha - 4Cb}}{2C}$$

b. The larger of the roots obtainable is not shown because it is of no value in this case. It should be noted that b , h , r , and R must be expressed in the same unit. The construction of an instrument to solve this equation for any given height of instru-

ment and any given condition of refraction is not difficult, provided there is a suitable ratio between the height of the instrument and the maximum range to be measured. Since the tide changes the effective height of instrument continually and since it would be impracticable to make a different instrument for every height of station, instruments are designed so as to be adjustable within certain limits as to the height at which they are to work. The principle which is used in designing this feature of most of our instruments is discussed in "The Journal of the United States Artillery," 1909, volume 31, page 48. Instruments in our service are designed to correct automatically for the effects of curvature and a normal refraction of the ratio 1/14 or ($m = 0.0714$). This is a mean for all values of refraction.

c. A change in refraction produces an apparent change in the height of the target relative to the instrument. Correction for such varying refraction may be made by changing the setting of the height scale on the instrument to make it read the correct range to a datum point in the part of the field of fire in which it is expected that the instrument will be used. The correction may also be made by a mechanical change in the angle of depression corresponding to the range to the datum point without varying the height setting. A combination of the two methods is used in our service.

5. VALUE OF C FOR USE IN COMPUTATIONS.

$$C = \frac{(1 - 2m)}{2r} = \text{the vertical effect of curvature}$$

and refraction when $R = 1$ yard. Based upon the values $r = 6,963,455$ yards and $m = 0.0714$, the following values may be listed:

$$\begin{aligned} C &= 0.000000061550 \\ \log C &= 2.78923 - 10 \\ \log 2C &= 3.09026 - 10 \\ \log 4C &= 3.39129 - 10 \end{aligned}$$

6. **EXAMPLE.** Given a height of instrument of 120 feet and a coefficient of refraction of 0.0714, what range corresponds to an angle of depression of 15 minutes?

Solution:

$$R = \frac{\tan \alpha - \sqrt{\tan^2 \alpha - 4Cb}}{2C},$$

where $a = 15'$ and $b = 120$ feet = 40 yards

Term	Logarithm	Natural number
$\tan \alpha$	7.63982 - 10	0.0043633
$\tan^2 \alpha$	5.27964 - 10	0.000019039
$4C$	3.39129 - 10	
b	1.60206	
$4Cb$	4.99335 - 10	0.000009848
$\tan^2 \alpha - 4Cb$	4.96336 - 10	0.000009191
$\sqrt{\tan^2 \alpha - 4Cb}$	7.48168 - 10	0.0030317
Numerator.....	7.12437 - 10	0.0013316
Denominator (2C).....	3.09026 - 10	
R	4.03411	10,817 yards.

Section II. EFFECT OF SMALL CHANGES IN THE DEPRESSION ANGLE

7. **GENERAL.** The range finding triangle has been described in section I. In figure 55 this triangle is ACT . The general formula as given is as follows:

$$\tan \alpha = \frac{b + CR^2}{R}$$

$$CR^2 = h = MC = MB$$

(See table I app. VI.)

The relation between small changes in a and small changes in R can be shown by either trigonometry or calculus. Both methods will be given here.

8. TRIGONOMETRIC METHOD. In analyzing small changes in range, the target may be considered to move on a line BT , figure 55, tangent to the apparent surface of the sea MT . Furthermore, although a and a_1 are not equal, it can be seen that since AT is common to both angles, any small change in a will be duplicated in a_1 and therefore Δa will be equal to Δa_1 . The triangle to be considered for small changes in range will be the triangle ADT in which AD is perpendicular to DT . It will be seen that this triangle is similar

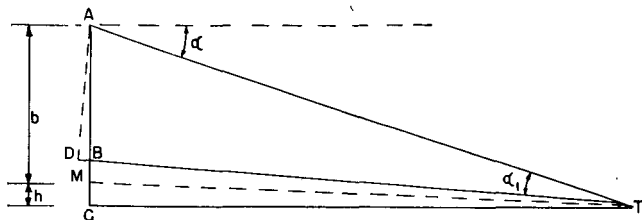

Figure 55. Range finding triangle, depression position finder.

to that described in appendix IV. The relation between Δa_1 , DT , and AD can be shown by substituting these values in equation (4) of appendix IV.

$$\Delta a_1 = - \frac{AD \times \Delta R}{DT^2} \quad (1)$$

Due to the small size of a_1 and $\angle DAB$

$$AD = AB \text{ (almost exactly)}$$

and

$$DT = BT \text{ (almost exactly)}$$

Therefore equation (1) can be written

$$\Delta\alpha_1 = - \frac{AB \times \Delta R}{BT^2}$$

Since

$$AB = (b-h)$$

and

$$BT = R$$

This equation becomes

$$\Delta\alpha_1 = - \frac{(b-h) \times \Delta R}{R^2} \quad (2)$$

But

$$\Delta\alpha_1 = \Delta\alpha$$

Therefore

$$\Delta\alpha \text{ (in radians)} = - \frac{(b-h) \times \Delta R}{R^2} \quad (3)$$

and

$$\Delta R = - \frac{R^2 \times \Delta\alpha}{(b-h)} \quad (4)$$

9. CALCULUS METHOD. The general formula

$$\tan \alpha = \frac{b + CR^2}{R}$$

can be simplified by making the following assumption

$$\tan \alpha = \alpha \text{ (in radians)}$$

therefore

$$\alpha = \frac{b + CR^2}{R}$$

by differentiation

$$\frac{d\alpha}{dR} = - \frac{b - CR^2}{R^2}$$

Substituting h for CR^2

$$\frac{d\alpha}{dR} = - \frac{(b-h)}{R^2}$$

$$d\alpha = - \frac{(b-h) dR}{R^2}$$

$$dR = - \frac{R^2 \times d\alpha}{(b-h)} \quad (5)$$

If Δa and ΔR are substituted for d_a and dR respectively, the equation becomes the same as equation (4).

10. CONVERSION FROM RADIANS TO SECONDS. Equations (3) and (4) are true only if Δa is expressed in radians. Since Δa is usually given in seconds, it is necessary that the formulas be corrected so that Δa may be expressed in seconds. Since a radian equals 206,265 seconds of arc, in order to use Δa in seconds of arc it becomes necessary to multiply its value in radians by 206,265. Sufficient accuracy is attained by making the figure 206,000. Equation (3) then becomes

$$\Delta\alpha \text{ (in seconds)} = - \frac{\Delta R \times (b-h) \times 206,000}{R^2} \quad (6)$$

and equation (4) becomes

$$\Delta R = - \frac{-R^2 \times \Delta\alpha}{(b-h) \times 206,000} \quad (7)$$

11. PROBABLE ERROR. If the probable error of the observer is r' seconds of arc, the probable error of range determination is

$$r_R = \frac{R^2 \times r'}{(b-h) \times 206,000}$$

12. EFFECT OF MAGNIFICATION OF INSTRUMENT ON OBSERVED ANGLES. The effect of magnification is to make smaller angles distinguishable. The distinguishable angle is taken as varying inversely as the power of the optical system. Let $\Delta a'$ represent the accuracy index of the observer (par. 41) and M the magnifying power of the observation instrument.

$$\text{Therefore } \Delta a' = M \times \Delta a.$$

Then equations (6) and (7) above may be written as shown on next page.

$$\Delta\alpha' = - \frac{\Delta R \times M \times (b-h) \times 206,000}{R^2} \quad (8)$$

$$\Delta R = - \frac{R^2 \times \Delta\alpha'}{(b-h) \times M \times 206,000} \quad (9)$$

13. USE OF EQUATIONS IN DETERMINING OBSERVER'S ERROR. Equation (8) may be used to determine the angular error of an observer by substituting his mean error in range for ΔR (see par. 43, ch. 4, and par. 4, app. IV).

Section III. EFFECT OF SMALL CHANGES IN HEIGHT OF INSTRUMENT

14. GENERAL. The effect on the indicated range caused by small changes in the height of instrument b may be found by finding the difference in the depression angle using the two values of b successively in the equation

$$\tan \alpha = \frac{b}{R} + CR$$

and then substituting the value of $\Delta\alpha$ thus found in equation (7) of paragraph 10. However, this effect may be determined with sufficient accuracy for practical purposes by the principle of similar triangles. In figure 56 any change in the angle of depression α will move the apparent position of the target along the arc MT which represents the surface of the earth. The tangent LT may be considered as coinciding with MT in the vicinity of the target and therefore as the line along which the apparent position of the target will be moved. Since the angle PTP' is very small (as shown in figure 56 it is greatly exaggerated), MP' is approximately equal to MP , the difference between apparent and true level due to curvature and refraction, and OP' is approximately equal to $(b-h)$.

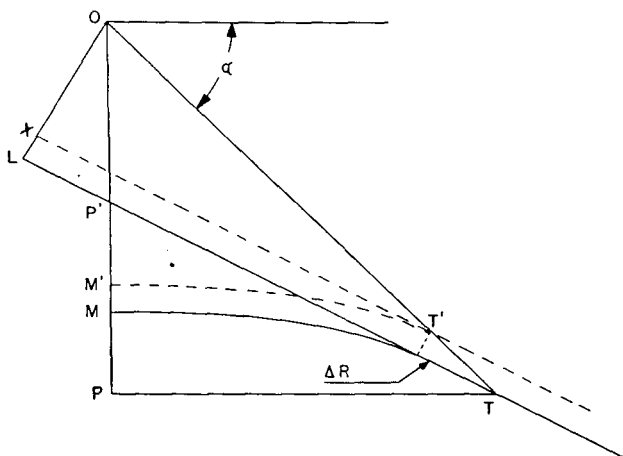

Figure 56. Effect of small changes in height of instrument.

This value is called the "effective height of instrument." In the right triangle OLT , LT is approximately equal to the range and OL to the effective height of instrument. Assume that after the tide correction was made the tide rose by a small amount XL . The instrument will indicate the range LT corresponding to the height OL , whereas the desired range is the range XT' . The error in range, ΔR , may be determined by the equation

$$\Delta R = LT \times XL/OL = R\Delta b/(b-h)$$

15. EXAMPLE. A D.P.F. has been adjusted to read the correct range by waterlining on a datum point at a 12,500-yard range. The height scale shows 150 feet as the height of instrument b . Assume that the tide has risen 1 foot since the adjustment was made. What range will be indicated on the instrument when it is again waterlined on the datum point?

Solution:

$$\begin{array}{l} \Delta R = R \Delta b / (b - h) \quad , \\ R = 12,500 \text{ yards} \quad \quad \quad h = 29 \text{ feet} \\ \Delta b = 1 \text{ foot} \quad \quad \quad b - h = 121 \text{ feet} \\ b = 150 \text{ feet} \end{array}$$

By slide rule $\Delta R = 103$ yards.

$$R' = 12,500 + 103 \text{ yards} = 12,603 \text{ yards.}$$

NOTE. Solution by equation (7) gives **12,613 yards.**

APPENDIX IV

EFFECT OF SMALL ERRORS WHEN USING SELF-CONTAINED RANGE FINDER

1. GENERAL. In the analysis of range finder errors, both systematic and accidental, it is necessary to resolve the linear errors, expressed in yards, into angular errors expressed in seconds of arc.

2. EFFECT ON RANGE OF SMALL CHANGES IN α . The equations showing the relation between small changes in range and small changes in the measured angle, as presented in chapter 4, are as follows:

$$\Delta\alpha = \frac{\Delta R \times b \times 206,000}{R^2}$$
$$\Delta\alpha' = \frac{\Delta R \times b \times M \times 206,000}{R^2}$$

where

ΔR = Small change (or error) in range.

R = Range.

b = Base length of the instrument, that is, the distance between the centers of the end windows.

M = Magnifying power of the instrument, that is, the ratio of the size of the image seen by the observer through the instrument to the size of the image as seen by the naked eye.

$\Delta\alpha$ = Actual change in α corresponding to ΔR in seconds of arc.

$\Delta\alpha' = M \times \Delta\alpha$ = Change in seconds of arc at the eye of the observer. ΔR , b , and R must be expressed in the same units.

Derivations of the above equations are given in the following paragraph.

3. DERIVATION OF FORMULAS. a. By geometry.

$$OB = b \text{ (length of base)}$$

$$BC = R$$

$$CD = \Delta R$$

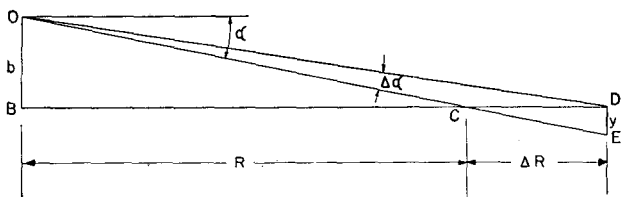

Figure 57. Range finding triangle, self-contained range finder.

Because of the small size of b when compared with R , α is very small and DE is almost perpendicular to OD . (This would be more apparent if the figure were drawn to scale.)

It now follows that

$$\Delta\alpha \text{ (in radians)} = \frac{y}{OD} \text{ (almost exactly)}$$

Likewise

$$OD = BD \text{ (almost exactly)}$$

$$OD = BD = R + \Delta R$$

Therefore

$$\Delta\alpha = \frac{y}{R + \Delta R} \quad (1)$$

By similar triangles

$$\frac{y}{\Delta R} = \frac{b}{R}$$

Therefore

$$y = \frac{b \times \Delta R}{R}$$

Substituting for y in equation (1)

$$\Delta\alpha = \frac{b \times \Delta R}{R(R + \Delta R)} \quad (2)$$

$$\Delta\alpha = \frac{b \times \Delta R}{R^2 \left(1 + \frac{\Delta R}{R}\right)}$$

But for small values of ΔR , $\frac{\Delta R}{R}$ is approximately zero. Thence, this reduces to

$$\Delta\alpha \text{ (in radians)} = \frac{b \times \Delta R}{R^2} \quad (3)$$

$$\Delta R = \frac{R^2 \times \Delta\alpha}{b}$$

Inspection of the figure will show that as a increases, R decreases. Therefore, a minus sign should be placed in front of the right side of the equation, thus

$$\Delta\alpha \text{ (in radians)} = - \frac{b \times \Delta R}{R^2} \quad (4)$$

$$\Delta R = - \frac{\Delta\alpha \times R^2}{b} \quad (5)$$

b. By calculus.

By differentiating

$$\alpha = \frac{b}{R}$$

$$\frac{d\alpha}{dR} = - \frac{b}{R^2}$$

The minus sign merely indicates that an increase in a causes a decrease in R . By substituting $\Delta\alpha$ and ΔR for $d\alpha$ and dR respectively,

$$\frac{\Delta\alpha}{\Delta R} = - \frac{b}{R^2}$$

or

$$\Delta\alpha = - \frac{b \times \Delta R}{R^2}$$

4. EFFECT OF MAGNIFICATION. The effect of magnification is to render smaller angular changes distinguishable. The change in a as seen by the observer's eye is M times the actual angular change of the line of sight.¹

¹Recent tests show that this statement is only roughly true, since loss of definition accompanies the increase in magnification except in periods of excellent visibility.

Considering $\Delta\alpha'$ as the angular shift of the line of sight at the observer's eye, and converting radians to seconds of arc, the equation becomes:

$$\Delta\alpha' = - \frac{\Delta R \times b \times M \times 206,000}{R^2} \quad (6)$$

5. EFFECT OF ANGULAR ERRORS ON RANGE.

Using an instrument of virtual base $b \times M$, an angular error at the observer's eye of $\Delta\alpha'$ seconds will, at range R , have an effect of ΔR , where

$$\Delta R = - \frac{R^2 \times \Delta\alpha'}{b \times M \times 206,000} \quad (7)$$

6. VALUE OF R TO BE USED. The equations given in the preceding paragraph are based on the true range to the target, and the range disk is graduated according to the equation $a = \frac{b}{R}$.

Because of this inverse relation between a and R , the range scale will be nonuniform. If the instrument is in perfect adjustment, the mean of a large number of readings should be equal to the true range to the target, and the true range would be used in solving for Δa . If, however, the instrument is not in adjustment and the mean of the observed readings does not equal the true range, the apparent accidental variations in range, as shown on the range scale, will not be the true errors. In order to determine the mean accidental error of the angular deviation exactly, the mean observed range would have to be used in the equations. However, for most practical purposes, it will be sufficiently accurate to use the true range to the datum point. When determining observer's angular errors the minus sign in equation (6) can be disregarded.

APPENDIX V

DERIVATION OF FORMULA SHOWING THE EFFECT OF CANT ON POINTING IN DIRECTION

The relation between the angle of inclination of the trunnions and the angular error in pointing when the gun is elevated is shown in the following demonstration. Figure 58 is a three-dimensional view of the angular relations involved. Point O is the intersection of the axis of the bore and the axis of the trunnions; OD is the inclined axis of the trunnions; OC is the axis of the bore in horizontal position. OH is the horizontal projection of OD . Plane $OHQM$ is a vertical plane containing the axis of the trunnions. $OMBC$ is a vertical plane perpendicular to OH . $ONAC$ is an inclined plane perpendicular to OD . As the gun is elevated, the axis of the bore will lie in plane $ONAC$ and will take a position such as OA . The angle of elevation ϕ measured in this inclined plane will be equal to angle AOC . The horizontal projection of OA is OE and the angular difference between OC and OE is the error in pointing and is called d_1 . Point B is the projection of A on the plane $OMBC$ and the line AB is horizontal. A study of the figure will show that angle BCA is equal to DOH and is the inclination (I) of the trunnions.

$$\tan d_1 = \frac{CE}{OC} \qquad \sin I = \frac{BA}{AC} \qquad (1)$$

$$CE = BA$$

$$\therefore \tan d_1 = \frac{BA}{OC}$$

$$\tan \phi = \frac{AC}{OC} \qquad (2)$$

Multiplying equation (1) by equation (2)

$$\sin I \times \tan \phi = \frac{BA}{AC} \times \frac{AC}{OC} = \frac{BA}{OC} = \tan d_1$$

$$\therefore \tan d_1 = \sin I \tan \phi \quad (3)$$

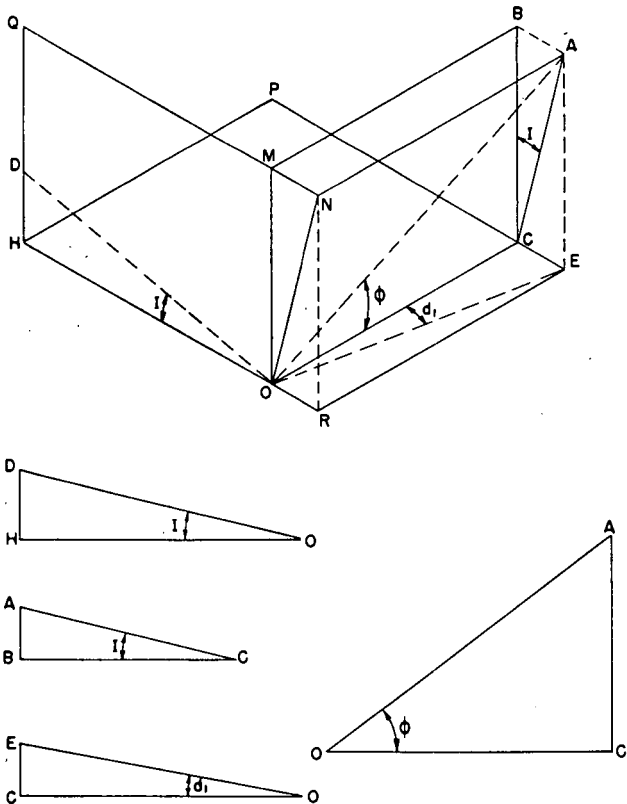

Figure 58. Effect of cant on pointing.

This is the true equation showing the relation between the error in pointing and the inclination of the trunnions. This equation may be simplified by the following process:

$$\frac{\tan d_1}{\sin I} = \tan \phi$$

For angles of less than 4° , the sine and tangent functions are approximately equal. Therefore, $\tan I$ can be substituted for $\sin I$, giving

$$\frac{\tan d_1}{\tan I} = \tan \phi$$

For such small angles the tangents are proportional to the angles themselves, and thus

$$\frac{\tan d_1}{\tan I} = \frac{d_1}{I}$$

$$\therefore \frac{d_1}{I} = \tan \phi$$

$$\text{and } d_1 = I \tan \phi$$

This approximate formula is the one usually used. An alternate method of deriving this approximate equation is as follows:

$$\tan d_1 = \sin I \tan \phi$$

For any very small angle α

$$\sin \alpha = \tan \alpha = \alpha$$

when α is measured in radians. Since d_1 and I are both very small angles, the angles themselves, if measured in radians, may be substituted for the sine and tangent functions. Therefore the equation becomes

$$d_1 = I \tan \phi$$

This equation will hold whether given in mils, degrees, or radians, since the conversion factor to convert from mils into degrees must be applied to both sides of the equation and will therefore cancel out. When this equation is used, d and I must be expressed in the same units.

APPENDIX VI

TABLES

TABLE I. *Vertical effect of curvature and refraction*
(par. 35c)

$h = (1 - 2m) \frac{R^2}{2r}$, in which h , R , and r are expressed in the same unit.

$C = \frac{(1 - 2m)}{2r} = 0.0000000615499$ when $m = 0.0714$ and $r = 6,963,455$ yards ($\log C = 2.78923 - 10$)

Range (thou- sands of yards)	Curvature and re- fraction (h) (in feet) $m=0.0714$	Range (thou- sands of yards)	Curvature and re- fraction (h) (in feet) $m=0.0714$	Range (thou- sands of yards)	Curvature and re- fraction (h) (in feet) $m=0.0714$
1.....	0.2	18.....	59.8	35.....	226.2
2.....	.7	19.....	66.7	36.....	239.3
3.....	1.7	20.....	73.9	37.....	252.8
4.....	3.0	21.....	81.4	38.....	266.6
5.....	4.6	22.....	89.4	39.....	280.9
6.....	6.6	23.....	97.7	40.....	295.4
7.....	9.0	24.....	106.4	41.....	310.4
8.....	11.8	25.....	115.4	42.....	325.7
9.....	15.0	26.....	124.8	43.....	341.4
10.....	18.5	27.....	134.6	44.....	357.5
11.....	22.3	28.....	144.8	45.....	373.9
12.....	26.6	29.....	155.3	46.....	390.7
13.....	31.2	30.....	166.2	47.....	407.9
14.....	36.2	31.....	177.5	48.....	425.4
15.....	41.5	32.....	189.1	49.....	443.3
16.....	47.3	33.....	201.1	50.....	461.6
17.....	53.4	34.....	213.5		

Enter the table with R to the nearest 100 yards; take the effect to the nearest foot.

TABLE II-A. *Factor—probability*

Factor	Probability	Factor	Probability	Factor	Probability	Factor	Probability
0.00	0.000	1.00	0.500	2.00	0.823	3.00	0.957
.05	.027	1.05	.521	2.05	.833	3.05	.960
.10	.054	1.10	.542	2.10	.843	3.10	.963
.15	.081	1.15	.562	2.15	.853	3.15	.966
.20	.107	1.20	.582	2.20	.862	3.20	.969
.25	.134	1.25	.601	2.25	.871	3.25	.972
.30	.160	1.30	.620	2.30	.879	3.30	.974
.35	.187	1.35	.638	2.35	.887	3.35	.976
.40	.213	1.40	.655	2.40	.895	3.40	.978
.45	.239	1.45	.672	2.45	.902	3.50	.982
.50	.264	1.50	.688	2.50	.908	3.60	.985
.55	.289	1.55	.704	2.55	.914	3.70	.987
.60	.314	1.60	.719	2.60	.920	3.80	.990
.65	.339	1.65	.734	2.65	.926	3.90	.992
.70	.363	1.70	.749	2.70	.931	4.00	.993
.75	.387	1.75	.762	2.75	.936	4.20	.995
.80	.411	1.80	.775	2.80	.941	4.40	.997
.85	.434	1.85	.788	2.85	.945	4.60	.998
.90	.456	1.90	.800	2.90	.949	4.80	.999
.95	.478	1.95	.812	2.95	.953	5.00	.999

TABLE II-B. *Probability—factor*

Proba- bility	Factor	Proba- bility	Factor	Proba- bility	Factor	Proba- bility	Factor
0.01	0.019	0.26	0.492	0.51	1.024	0.76	1.742
.02	.037	.27	.512	.52	1.047	.77	1.780
.03	.056	.28	.532	.53	1.071	.78	1.819
.04	.074	.29	.551	.54	1.096	.79	1.858
.05	.093	.30	.571	.55	1.121	.80	1.900
.06	.112	.31	.592	.56	1.146	.81	1.943
.07	.130	.32	.612	.57	1.172	.82	1.988
.08	.148	.33	.632	.58	1.197	.83	2.035
.09	.167	.34	.652	.59	1.222	.84	2.084
.10	.186	.35	.673	.60	1.248	.85	2.134
.11	.205	.36	.693	.61	1.275	.86	2.185
.12	.224	.37	.714	.62	1.302	.87	2.239
.13	.243	.38	.735	.63	1.329	.88	2.301
.14	.262	.39	.757	.64	1.357	.89	2.365
.15	.281	.40	.778	.65	1.386	.90	2.439
.16	.299	.41	.800	.66	1.415	.91	2.514
.17	.318	.42	.822	.67	1.444	.92	2.596
.18	.337	.43	.843	.68	1.473	.93	2.687
.19	.357	.44	.864	.69	1.505	.94	2.788
.20	.376	.45	.886	.70	1.537	.95	2.906
.21	.395	.46	.909	.71	1.569	.96	3.044
.22	.415	.47	.931	.72	1.602	.97	3.218
.23	.434	.48	.954	.73	1.636	.98	3.451
.24	.453	.49	.977	.74	1.671	.99	3.815
.25	.473	.50	1.000	.75	1.706	1.00	

APPENDIX VII

LIST OF REFERENCES

The following publications should be consulted:

- FM 4-15 Fire Control and Position Finding.
- FM 4-30 Service of Gun Data Computer M1.
- FM 4-95 Service of Radio Set SCR-296-A.
- FM 4-96 Service of Radio Set SCR-582.
- FM 4-97 Service of Radio Set SCR-682-A (when published).
- TM 4-225 Orientation.
- TM 4-240 Meteorology for Coast Artillery.
- TM 5-236 Surveying Tables.
- TM 9-1646 Gun Data Computer M1.
- SNL F-69 Firing Tables and Trajectory Charts.
- Text on Exterior Ballistics, the Ordnance School, Ordnance Department, United States Army.
- Computation of Firing Tables for United States Army, H. P. Hitchcock.
- Elements of Ordnance, Hayes.
- Ordnance and Gunnery, McFarland.
- Naval Ordnance, United States Naval Institute.

Reference to FM 21-6, List of Publications for Training (1 February 1944), will assist in finding other Field Manuals and Technical Manuals pertaining to gunnery.

INDEX

	Paragraphs	Page
Accidental errors:		
Curve	80, 81	136, 138
Definition	68c	119
Accuracy index:		
Computation:		
General	40b	74
Self-contained base system	45	78
Vertical base system....	48	83
Equations, use	App. III	227
Accuracy of observation:		
Horizontal base system	37	70
Self-contained base system..	44	77
Vertical base system	47	82
Adjustment of cross-level bubble, compensating sight mount	58	100
Adjustment of fire:		
Adjustment correction, method of applying	114	180
Basic principles	111	178
Bracketing method	121-123	195
Classification of fire.....	116	183
Coordination of the adjusters and the battery.....	115	181
Fire adjustment board.....	117	184
Fire for effect:		
Bracketing method	123	196
Magnitude method	119	185
Lateral adjustment	113, 124-127	180, 204
Magnitude method	117-120	184
Method of lateral adjustment	113	180
Methods of range adjustment	112	179
Problem	110	178
Range adjustment	112, 117-123	179, 184
Simulated fire, adjustment...	128-132	213
Trial fire:		
Bracketing method	122	195
Magnitude method	118	184

	Paragraphs	Page
Aiming points	60-65	104
Alternate aiming points	64	112
Determination of error.....	62	106
Errors arising from use.....	61	104
Selection	63, 65	110, 112
Air resistance to projectile in flight	12	8
Air temperature	20e	18
Alternate aiming points.....	64	112
Angular errors, self-contained range finder, effect on range...	App. IV	239
Armament error	68f	121
Armament probable error.....	68g	121
Atmospheric conditions:		
Density	20d	17
Temperature	20e	18
Atmospheric refraction	35, App. III	65, 227
Axial spotting	100a	166
Lateral	101	167
Range	104	168
Azimuth instrument M1910A1....	107	170
Ballistic coefficient C.....	13	9
Ballistic conditions:		
Nonstandard	18	12
Standard	17	12
Ballistic density	20d	17
Ballistic wind	20f, 21b	20, 21
Ballistics:		
Exterior	5	3
Interior	4	3
Base lines, horizontal base system	36	69
Bilateral spotting	100b	166
Lateral	102	167
Range	105	169
Bore, conditions causing errors..	71	123
Bracketing method of range adjustment:		
Fire for effect.....	123	196
General	121	195
Trial fire	122	195
Calibration:		
Application of corrections...	90-92	146
Calculation of corrections....	96-98	153
Calibration fire	93-95	151
Definition	84	144
General	85-89	144
Calibration piece	87	145

	Paragraphs	Page
Cant	52-54	90
Analogy	53	92
Corrective measures	54	93
Derivation of formula.....	App. V	243
Carriage, conditions causing error	70	122
Center of dispersion.....	79	135
Center of impact.....	67	116
Chart of field of fire.....	33	61
Check points, computation with plotting boards	50, 51	85
Classification of fire	116	183
Coincidence range finders.....	43-45	76
Compensating sight mounts:		
Construction	55	93
Cross level out of adjustment	57	98
Examples	59	102
Method of checking adjust- ment of cross-level bubble.	58	100
Sources of error	56	97
Compound errors	83	142
Computers, gun data:		
Aided tracking device.....	41	75
Operation	41	75
Purpose	41	75
Use:		
Horizontal base system..	41	75
Radar	41	75
Vertical base system....	41	75
Conduct of fire, calibration fire..	94	152
Correction adjustment. <i>See</i> ad- justment of fire.		
Corrections:		
Firing data	19	13
Nonstandard ballistic condi- tions	18	12
Curvature and refraction.....	35	65
Combined effect	App. III	227
Table, vertical effect	App. VI	246
Curvature of the earth, effect....	35, App. III	65, 227
Curve of accidental errors, use of, in computation of probability of hitting	80, 81	136, 138
Dead areas, definition	27c	44
Deflade, definition	27b	44
Density, atmospheric	20d	17
Density of loading.....	71f	126
Depression angle:		
Effect of small changes in, depression position finder.	App. III	227

	Paragraphs	Page
Depression angle— <i>Continued</i> :		
Range finding	App. III	227
Depression position finder, factors affecting accuracy	47, 108	82, 170
Developed armament probable error	68g	121
Developed muzzle velocity	20c, 97	16, 153
Deviations	67	116
Direction, conditions affecting ...	21	21
Dispersion	78, 79	130, 135
Centers of impact	82	140
Use of ladder in computation of probability of hitting...	79	135
Dispersion box	129	213
Dispersion tape and scale, fire adjustment	129	213
Drift	21c	22
Effect of:		
Angular errors on range....	App. IV	239
Cant on pointing.....	App. V	243
Magnification, depression position finder	App. III	227
Magnification, self-contained range finder	App. IV	239
Small changes in height of instrument, depression position finder	App. III	227
Small changes in observed azimuths, horizontal base system	App. II	219
Small changes in the depression angle, depression position finder	App. III	227
Effective height of instrument, depression position finder	46	80
Elements of trajectory:		
Initial	8	4
Intrinsic	7	4
Other elements	10	6
Terminal	9	6
Elevation, minimum	29, 30	45, 46
Erosion of the guns.....	20c	16
Errors:		
Accidental	80, 81, 68c	136, 138, 119
Aiming point	62	106
Angular error, self-contained range finder	App. IV	239

Errors—Continued:	Paragraphs	Page
Armament	68f	121
Causes	69-73	122
Conditions during flight.	72	127
Conditions in the bore..	71	123
Conditions in the carriage	70	122
Compound	83	142
Definitions	67, 68	116, 119
Developed armament proba- ble error	68g	121
Distribution	82, 83	140, 142
Due to sight displacement...	61-63	104
Observed ranges	39	71
Personnel	68a	119
Pointing	63b	111
Probable	68e	120
Segregation by analysis.....	73	127
Systematic	68b	119
Exterior ballistics	5	3
Field of fire chart	33	61
Fire, classification	116	183
Fire adjustment. See adjustment of fire.		
Fire for effect:		
Bracketing method	123	196
Magnitude method	119	185
Firing, calibration	93-95	151
Firing data, corrections	19	13
Firing table computations, pre- cision required	22	22
Firing tables	15-22, 23-26	10, 23
Contents	16	11
Examples	24-26	24
Nonstandard ballistic condi- tions	18	12
Standard ballistic conditions.	17	12
Fork	27e	44
Glossary	App. I	217
Height of instrument, depression position finder, effect of small changes	App. III	227
Height of instrument, depression position finder, effective	46	80
Height of site	20a	14
Hitting, probability	81	138
Horizontal base system.....	36, 37, App. II	69, 70, 219

	Paragraphs	Page
Initial elements of trajectory....	8	4
Interior ballistics	4	3
Intrinsic elements of trajectory..	7	4
Jumping splashes	126	207
Landward areas	32d	56
Lateral adjustment:		
General	124	204
Jumping splashes	126	207
Method	113, 125	180, 205
Problems	127	208
Limitations of fire, due to position	28	44
Loading, density	71f	126
Magnification:		
Depression position finder ..	App. III	227
Self-contained range finder.	App. IV	239
Magnitude method of range ad- justment:		
Description	120	185
Fire for effect	119	185
General	117	184
Trial fire	118	184
Masks	28c	45
Definition	27a	44
Distant masks	30a	46
Near masks	30a	46
Meteorological message	20, 24-26	14, 24
Minimum elevation, determina- tion	29, 30	45, 46
Minimum range, determination..	31-32	50
Muzzle velocity	20c, 71, 97	16, 123, 153
Nonstandard ballistic conditions.	18	12
Observation:		
Horizontal base system.....	37	70
Self-contained base system..	44	77
Vertical base system	47	82
Observation of fire, calibration fire	95	153
Observed azimuths, effects of small changes	App. II	219
Observer's error. See accuracy index.		
Personnel errors	68a	119
Plotting boards, check of ac- curacy	49-51	85

	Paragraphs	Page
Pointing:		
Aiming point	60-65	104
Cant	52-54	90
Compensating sight mounts.	55-59	93
Position-finding systems:		
Accuracy of self-contained and vertical base systems.	38-42	71
General	34-35	65
Horizontal base system	36, 37	69, 70
Self-contained base system..	43-45	76
Vertical base system	46-48	80
Powder:		
Composition	71b	123
Density of loading	71f	126
Ignition	71c	124
Temperature	20c	16
Variations in temperature ...	71a	123
Powder tag velocity	20c	16
Precision in firing table compu- tations	22	22
Preparation for fire, calibration fire	93	151
Probability:		
Factor	80c	137
Hitting	81	138
Mathematics	74-77	128
Numbers used	75	129
Rule for addition.....	76	129
Rule for multiplication.	77	129
Tables	App. VI	246
Probable error	68d	119
Definition	27d	44
Horizontal base system	App. II	219
Range finding	App. III	227
Spotting	App. II	219
Two-station spotting system.	App. II	219
Vertical base system	App. III	227
Projectile, weight	20b	15
Radar:		
General	42	76
Spotting	100c	167
Radians, conversion to seconds...	App. III	227
Range:		
Conditions affecting	20	14
Minimum	31-32	50
Range adjustment:		
Bracketing method	121-123	195
Magnitude method	117-120	184

	Paragraphs	Page
Range adjustment—Methods	112	179
Range finders. <i>See</i> self-contained range finders. <i>See</i> depression position finders.		
Range finding by depression angle	App. III	227
Range-finding triangle, self-con- tained and vertical base systems	38	71
Reference piece	87	145
Refraction, atmospheric. <i>See</i> at- mospheric refraction.		
Rotation of the earth:		
Affecting direction	21d	22
Affecting range	20g	21
Selection of aiming points	60-65	104
Self-contained base system	38-42	71
Self-contained range finders	43-45	76
Shot, wild	111e	179
Sight displacement, errors	61-63	104
Sight mounts, compensating. <i>See</i> compensating sight mounts.		
Simulated fire:		
Dispersion box	129	213
General	128	213
Instructions for use	130	215
Operation in drill	131	216
Use with spotting board	132	216
Spotting	99-109	166
Axial	100a	166
Lateral	101	167
Range	103	167
Bilateral	100c	167
Lateral	102	167
Range	105	169
Flank	100b, 104	166, 168
Instruments, accuracy	106-109	169
Lateral	101-102	167
Radar	100d	167
Range	103-105	167
Two-station spotting system.	App. II	219
Spotting board	109	171
Standard ballistic conditions	17	12
Stereoscopic range finders	43-45	76
Systematic errors	68b	119
Tables:		
Factor—probability	App. VI	246
Probability—factor	App. VI	246
Vertical effect of curvature and refraction	App. VI	246

	Paragraphs	Page
Temperature:		
Air	20e	18
Powder	20c	16
Terminal elements of trajectory.	9	6
Tide	20a	14
Timing	115a	181
Timing diagram	115b	181
Trajectory	6-14	4
Definition	6	4
Elements	7-10	4
In air	14	9
In vacuo	11	7
Trial fire:		
Bracketing method	122	195
Magnitude method	118	184
Two-station spotting system....	App. II	219
Velocity, powder tag.....	20c	16
Vertical base system	38-42, App. III	71, 227
Visibility	44d	78
Warming-up effect	89	146
Weight of projectile.....	20b	15
Weighting factors	88	145
Wild shot	111e	179
Wind:		
Affecting direction	21b	15
Affecting range	20f	20
Zone, dispersion	78b	130
Zone, 50 percent	79a	135