



This is a digital copy of a book that was preserved for generations on library shelves before it was carefully scanned by Google as part of a project to make the world's books discoverable online.

It has survived long enough for the copyright to expire and the book to enter the public domain. A public domain book is one that was never subject to copyright or whose legal copyright term has expired. Whether a book is in the public domain may vary country to country. Public domain books are our gateways to the past, representing a wealth of history, culture and knowledge that's often difficult to discover.

Marks, notations and other marginalia present in the original volume will appear in this file - a reminder of this book's long journey from the publisher to a library and finally to you.

Usage guidelines

Google is proud to partner with libraries to digitize public domain materials and make them widely accessible. Public domain books belong to the public and we are merely their custodians. Nevertheless, this work is expensive, so in order to keep providing this resource, we have taken steps to prevent abuse by commercial parties, including placing technical restrictions on automated querying.

We also ask that you:

- + *Make non-commercial use of the files* We designed Google Book Search for use by individuals, and we request that you use these files for personal, non-commercial purposes.
- + *Refrain from automated querying* Do not send automated queries of any sort to Google's system: If you are conducting research on machine translation, optical character recognition or other areas where access to a large amount of text is helpful, please contact us. We encourage the use of public domain materials for these purposes and may be able to help.
- + *Maintain attribution* The Google "watermark" you see on each file is essential for informing people about this project and helping them find additional materials through Google Book Search. Please do not remove it.
- + *Keep it legal* Whatever your use, remember that you are responsible for ensuring that what you are doing is legal. Do not assume that just because we believe a book is in the public domain for users in the United States, that the work is also in the public domain for users in other countries. Whether a book is still in copyright varies from country to country, and we can't offer guidance on whether any specific use of any specific book is allowed. Please do not assume that a book's appearance in Google Book Search means it can be used in any manner anywhere in the world. Copyright infringement liability can be quite severe.

About Google Book Search

Google's mission is to organize the world's information and to make it universally accessible and useful. Google Book Search helps readers discover the world's books while helping authors and publishers reach new audiences. You can search through the full text of this book on the web at <http://books.google.com/>

UC-NRLF



B 3 141 354

Measurement
of
Gas and Liquids
by
Orifice Meter

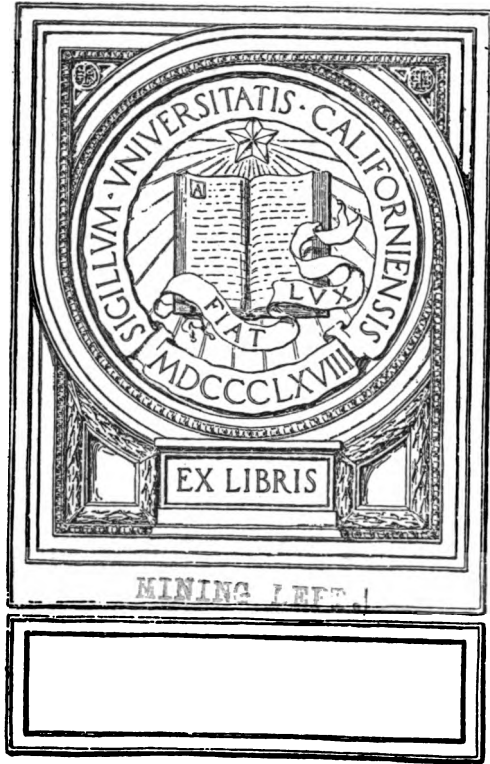

MINING LIBRARY

Book Jan. 165
Bird domain - 243

**MEASUREMENT
OF
GAS AND LIQUIDS
BY ORIFICE METER**

BY
HENRY P. WESTCOTT

Author of "Hand Book of Natural Gas," "Hand Book of
Casinghead Gas," "Measurement of Gases Where
Density Changes," and "Pressure Extensions."

ASSISTED BY
JOHN C. DIEHL

**SECOND EDITION
1922**



PUBLISHED BY
METRIC METAL WORKS
ERIE, PENNSYLVANIA

TN 880

W 43

1922.

MINING DEPT.

COPYRIGHTED 1922
By METRIC METAL WORKS

TO THE
MINING DEPT.

PRESS OF
ASHBY PRINTING CO
ERIE—PITTSBURGH

PREFACE

The first edition of "Measurement of Gas by Orifice Meter" published in 1918 was the first instance that we know of where the complete data pertaining to the orifice meter and orifice measurement was presented in book form, and it is gratifying to both the author and the publisher to know that the book was received with such favor as to have exhausted the edition in a comparatively short time.

Due to the universal need that the first edition has met, and our desire to continue to publish authoritative information regarding the orifice meter and its varied uses, we are pleased to present this second edition. This edition has been thoroughly revised and enlarged giving more detailed and complete information, including data for the measurement of air, steam, water and oil.

The tables of pressure extensions contained in the first edition are omitted in this book, and are now published by themselves in a book entitled "Pressure Extensions."

It is hoped that this volume in its enlarged form may further establish the acceptance of orifice meter measurement as a standard method and assist both engineers and laymen to a greater extent than before.

The author and publisher again gratefully acknowledge the valuable assistance rendered by the men who helped with the first edition as well as the assistance rendered by the engineers of the Bureau of Mines and business associates who have so kindly contributed to make this second edition more complete.

473612

TABLE OF CONTENTS

	PAGE
PREFACE.....	iii
PART ONE—GENERAL	
Orifice Meter.....	1
Pitot Tube and Meter.....	2
Description of first Pitot Tube.....	2
Pitot Tube, Measurement of Open Flow of Gas Well.....	3
Oliphant Pitot Tube.....	3
Portable Pitot Tip and Box.....	5
Pitot Meter Installation.....	6
Pitot Meter Operation.....	6
Orifice Meter and Differential Gauge, History.....	11
Differential Gauges, Development.....	13
“Bomb Shell” Type.....	14
Adaptability of Orifice Meter.....	17
PART TWO—PHYSICAL PROPERTIES OF FLUIDS	
Fluids.....	19
Theory of Constitution of Matter.....	19
States of Matter.....	19
Fluids, Liquids and Gases.....	20
Vapor.....	21
Vapor and Gas, Distinction between.....	21
Critical Temperatures and Pressures of Various Gases (Table).....	21
Gravitation.....	22
Force of Gravity.....	22
Fluid Pressure.....	22
Compressibility and Expansibility of Gases.....	25
Expansive Power of Gases.....	26
Pascal’s Law.....	27
Pressure and Liquid Head.....	28
Pressure Equivalents (Table).....	31
Pressure Equivalents, Mercury, Water, lb. per sq. in.....	32
Atmospheric Pressure.....	32
Barometer.....	33

TABLE OF CONTENTS

PART TWO—PHYSICAL PROPERTIES OF FLUIDS—Continued		PAGE
Absolute Pressure.....		34
Atmospheric Pressure of Gas Fields.....		35
Pressure Gauges.....		36
Spring Gauges.....		36
U Tubes or Siphon Gauges.....		38
Static Pressure.....		39
Vacuum.....		39
Vacuum—Absolute Pressure (Table).....		43
Pressure Base.....		44
Velocity.....		44
Uniform or varied motion.....		45
Acceleration.....		45
Velocity Head.....		46
Fluid Velocity.....		47
Coefficient of Velocity.....		50
Temperature.....		51
Absolute Temperature.....		51
Temperature Base.....		52
Perfect Gases.....		53
Charles' Law.....		53
Boyle's Law.....		55
Absolute Temperature—Absolute Pressure.....		57
Law of Perfect Gases.....		59
Pressure Due to Head of Gas.....		62
Pressure and Gas Heads.....		63
Velocity Head of Flowing Gases.....		64
PART THREE—ORIFICE METER MEASUREMENT		
General Description.....		67
Orifice Meter Layout.....		69
Orifices.....		73
Orifice Constants (Table).....		75
Orifice Meter Body.....		76
Determination of Orifice Coefficients.....		77
Coefficients for Pipe Connections.....		77
Joplin Holder Tests.....		78
Derivation of Orifice Meter Formula for Flow of Air.....		79
Orifice Meter Formula for Gas.....		80
General Outline.....		82
Leakage Tests—Joplin Holder.....		83

TABLE OF CONTENTS

PART THREE—ORIFICE METER MEASURE- MENT—Continued

	PAGE
Change of Volume of Holder with Temperature.....	83
Procedure during Orifice Tests.....	91
Summary of Results of Tests.....	94
Comparison with Charlottenburg Tests.....	98
Summary of Charlottenburg and Joplin Tests.....	98
Erie Holder Tests.....	99
Erie Holder.....	100
Leakage Tests.....	101
Summary Erie Tests.....	104
Status of Coefficient.....	106
Comparison—Joplin, Wann Line and Erie Tests.....	107
Values of Coefficient of Velocity (Diagram).....	108-109
Measuring Flow of Fluids.....	110
Application Velocity Formula for Flow of Air.....	111
Application of Velocity Formula for Flow of Gas.....	112
Application of Velocity Formula for Flow of Water.....	113
Application of Velocity Formula for Flow of Oil.....	114
Mercury Float Type Differential Gauges.....	117
Sectional View of Differential Gauge.....	119
Temperature Effect on Differential Gauges.....	120
Accuracy of Orifice Meter.....	121
Percentage Variations.....	123
Differential Gauge Capacities.....	126
Differential Range.....	126
Special Types of Gauges.....	129
Differential Gauge, 2½ inch Range.....	129
Combination 25 inch and 100 inch Differential Gauge.....	129
Indicating Gauge.....	130
Recording Differential and Static Pressure and Temperature Gauge.....	132
Relation Differential to Pressure.....	132
Relationship between Static Pressure and Location of Orifice.....	134
Hourly Coefficients for 4 inch Pipe (Diagram).....	134
Pressure Connections or Taps.....	135
Friction Loss.....	136
Percentage of Friction Loss to Differential.....	136
Friction Loss vs. Capacity.....	139
Pressure Loss.....	141

TABLE OF CONTENTS

PART THREE—ORIFICE METER MEASURE- MENT—Continued

	PAGE
Pulsating Flow.....	143
Pulsation vs. Vibration.....	145
Vibration of Differential Pen Arm.....	145
Pulsation.....	146
Determination of Pulsating Flow.....	147
Instructions to Meter Attendants.....	152
Changing Orifice Meter Charts.....	152
Testing Apparatus.....	154
Inspectors Test Pump for Static Pressure Gauges.....	154
Vacuum Gauge Test Pump.....	155
Pocket Gauge for Testing Differential Gauges.....	156
Siphon or U Gauges.....	157
Permanent Gauges for Testing Differential Gauges.....	158
Portable Water Differential Test Gauges.....	159

PART FOUR—MEASUREMENT OF GAS AND AIR

General Description.....	161
Derivation of Coefficients.....	163
Coefficient of Velocity.....	171
Hourly Orifice Coefficients for Gas 2½ and 8 Diameter Connections.....	171
Atmospheric Pressure 14.4.....	173-180
Atmospheric Pressure 14.7.....	181-184
Specific Gravity.....	186
Multipliers for Revision of Coefficients.....	186
Multipliers for Change of Pressure Base.....	188
Multipliers for Atmospheric Pressure Changes.....	189
Multipliers for Base Temperature Changes.....	191
Multipliers for Changes of Flowing Temperature.....	192
Multipliers for Specific Gravity Changes.....	193
Pressure Base Multipliers (Tables).....	195
Multipliers for Atmospheric Pressure Changes (Table)...	196
Base Temperature Multipliers (Table).....	197
Flowing Temperature Multipliers (Table).....	198
Specific Gravity Multipliers (Tables).....	199-200
Specifications for Orifice Meter Computations for the Osage Nation.....	202
Values of C_v for 2½ and 8 Diameter Connections.....	208
Values of C_v for Flange Connections.....	211

TABLE OF CONTENTS

PART FOUR—MEASUREMENT OF GAS AND AIR—Continued

	PAGE
Hourly Orifice Coefficients for Gas and Air, pressures taken at Flanges.....	213
Orifice Capacities for Air, Pipe Connections.....	214
Orifice Capacities for Gas, Pipe Connections.....	215
Orifice Capacities for Air, Flange Connections.....	216
Orifice Capacities for Gas, Flange Connections.....	217
Measurement of Gas in large volume.....	219
Effect of Atmospheric Pressure on Gas Measurement.....	221
Gas Contracts.....	230
Multiple Orifice Meter Installation.....	236
Installing Gas or Air Meters.....	239
Orifice Meter Installations for Measuring Gases.....	241
Orifice Meter Body.....	245
Orifice Meter Flanges.....	245
Gauge Line Connections.....	245
Orifice Meter for Coke Oven Gas.....	246
Installing Differential and Static Pressure Gauge.....	247
Setting up Gauge.....	247
Differential Pen Arm.....	247
Adding Mercury.....	247
Static Pressure Connections.....	248
By-Pass.....	248
Turning on Gas or Air.....	249
Leaks.....	249
Orifice Capacities.....	249
Vibrating Differential Pen Arm.....	250
Diagrams—Installations for Measuring Gas or Air.....	251-254
Testing Differential Gauges for Measuring Gas or Air.....	255
Checking Gauge for Zero.....	255
Checking Differential Gauge on Pressure Lines.....	256
Checking Differential Gauge on Vacuum Lines.....	256
Checking Differential Gauges under Working Pressure.....	258
Adjustment.....	258
Testing Static Spring.....	258
Orifice Meter Test Report.....	259
Reading Charts.....	261
Orifice Meter Calculator.....	267
Form for Face of Envelope used for Filing Orifice Meter Charts.....	270

TABLE OF CONTENTS

	PAGE
PART FIVE—MEASUREMENT OF STEAM	
General.....	271
Derivation of Coefficients.....	273
Properties of Saturated Steam (Table).....	277
Hourly Orifice Coefficients.....	282, 287
Hourly Capacity of Orifice for Steam.....	291-292
Tests, Steam Measurement.....	294
Installing and Testing Steam Meters.....	296
Diagrams of Installations for Measuring Steam.....	303
PART SIX—MEASUREMENT OF WATER	
General.....	307
Derivation of Coefficients.....	309
Hourly Orifice Coefficients for Water.....	312
Differential Pressure Extensions.....	313
Hourly Capacity of Orifices for Water.....	314
Water Measurement Tests.....	315
Installing and Testing Water Meters.....	316
PART SEVEN—MEASUREMENT OF OIL	
General.....	319
Derivation of Coefficients.....	322
Hourly Coefficients for Oil.....	330
Multipliers for Specific Gravity and Viscosity.....	331
Hourly Capacities of Orifice for Oil.....	332
Oil Measurement Tests.....	333
Installing and Testing Oil Meters.....	335
PART EIGHT—ORIFICE CAPACITIES	
General.....	341
Orifice Capacities for Gas, Pipe Connections (Tables)....	344-383
Orifice Capacities for Gas, Flange Connections (Tables)..	384-423
Orifice Capacity Diagrams.....	424-428
Information Required when Ordering Meters.....	425

PART ONE

GENERAL

ORIFICE METER—PITOT TUBE AND METER— HISTORY AND USES OF ORIFICE METERS AND DIFFERENTIAL GAUGES

ORIFICE METER

During the past decade no type of volume measuring apparatus has received as much attention as the simplest form of velocity meter, the orifice meter. This type of meter with the differential gauge has proven to be the most accurate and dependable apparatus designed for the measurement of gases and liquids flowing in pipe lines. It is being used successfully for measuring hydrogen, the lightest of commercial gases, and hot tar, one of the most viscous of liquids. The shape and design of the orifices have undergone minor changes, the main improvements have been made in the differential gauge which today will indicate and record readings within $\frac{1}{500}$ of its total range under pressures from 28 inches of mercury vacuum to 500 lb. per square inch.

This type of meter has been recognized by the Courts and State commissions as an instrument for correct measurement. It has passed the acid test of reliability and millions of cubic feet of gas are paid for daily, according to its records.

Many simple and complicated forms of velocity meters have been designed, but up to the present none have obtained any advantage over the orifice except at the expense of those most fundamental qualities, accuracy and dependability.

PITOT TUBE AND METER

The Pitot Tube was first used for measuring flowing streams of water and only in recent years has it been applied to measuring gas.

As first constructed it measured the velocity or impact of the flowing water and indicated it in a bent glass tube. In its simplest form (Fig. 1) it consisted of a bent tube, the mouth of which was placed pointing upstream and measured the impact or dynamic pressure made by the flowing water. The water raised in the vertical part of the bent tube to a height above the surface of the flowing stream and this height h was equal to the velocity-head $V^2/2g$, so that the actual velocity V was practically equal to $\sqrt{2gh}$. As constructed for use in streams, Pitot's apparatus consisted of two tubes placed side by side with their submerged mouths at right angles so that when one is opposed to the current, the other stood normal to it.

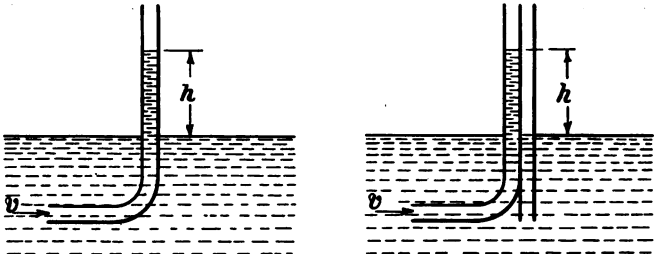

Fig. 1—PITOT TUBE USED IN MEASURING FLOWING STREAMS

Henri Pitot (Pē'tōt) the inventor of the Pitot Tube, was a French Physicist and Engineer. He was born in 1695, and died in 1771.

From the foregoing invention was evolved the method commonly used to measure the open flow of gas wells.

In testing gas wells only one tube was used, as the gas flowing from a gas well had a free exit into the atmosphere, and consequently had no static pressure.

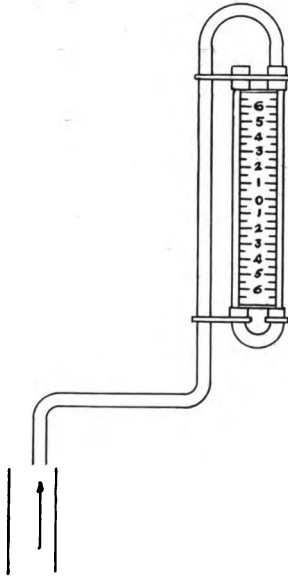

Fig. 2—PITOT TUBE MEASURING THE VOLUME OF GAS FLOWING FROM A GAS WELL

Oliphant Pitot Tube—A rough sketch of the Pitot Tube as used for the measurement of natural gas is shown in Fig. 3.

The principles of this tube, however, are identically the same as those used in the more refined tube of to-day. **A** was a piece of $\frac{3}{8}$ inch iron pipe, L shaped and inserted in a 4 inch pipe so that the open end **A** came directly in the centre of the pipe. Another piece of straight $\frac{3}{8}$ inch pipe **B** was placed one foot distant from the point **C** on the upstream side. On account of the gas flowing against the open end **A**, the static and dynamic pressures were transmitted to the U tube, while only the static pressure was

transmitted from the point **B**. In the U tube between **B** and **C** the static pressure was counterbalanced by itself, therefore it was the dynamic pressure which caused the water in the U tube to rise to the height h . This h then

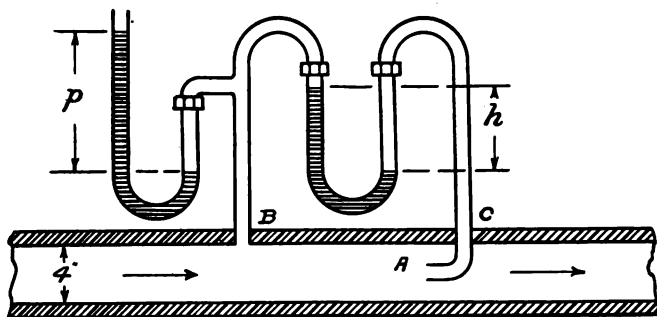

Fig. 3—SKETCH OF PITOT TUBE USED IN MEASURING FLOWING GAS IN A PIPE LINE

was the height of water, or pressure which would produce the velocity V of the gas flowing in the pipe line. The static, or gauge pressure p was observed by means of a large U tube filled with mercury, one column being con-

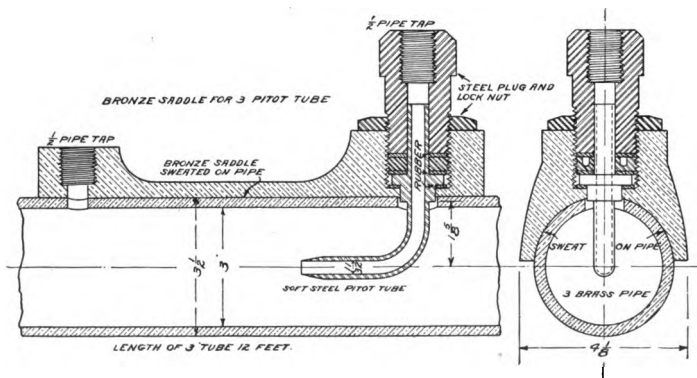

Fig. 4—SECTIONAL VIEW OF THE OLIPHANT PITOT TUBE, SHOWING SADDLE, TIP AND SECTION OF BRASS TUBE

GENERAL

nected to the connection at B and the other column open to the atmosphere. The Pitot Tube was then calibrated and the coefficient for it was determined by passing gas through it into a large gas holder under varying conditions of flow and pressure. Other tubes were then made by comparing them to these tubes, and as they proved very successful it was determined to make more refined tubes of various sizes, and again compare them with the gas holder, thus providing what are known as Standard Tubes with which all other tubes are compared and their coefficients determined.

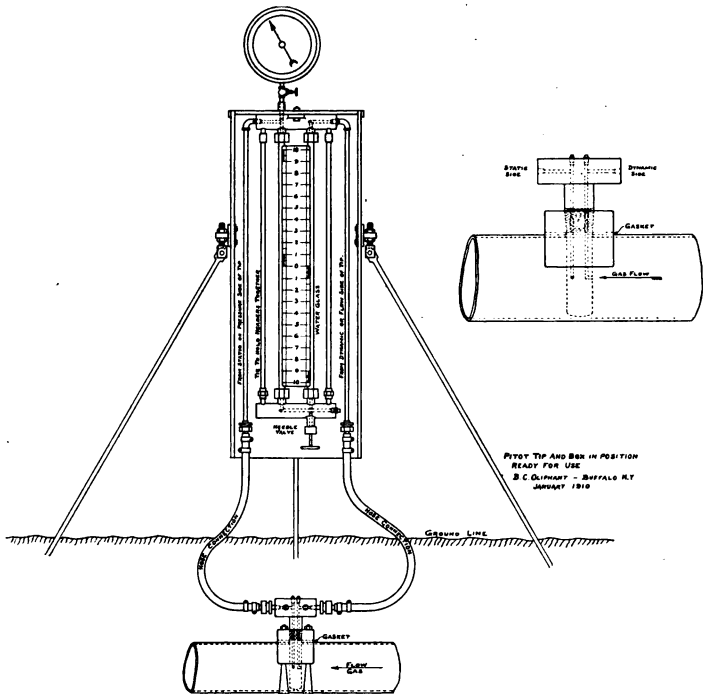

Fig. 5—PORTABLE PITOT TIP AND BOX

Portable Pitot Tip and Box—In January, 1910, Mr. Oliphant found the need for a Pitot Tube that could be quickly and easily transported from place to place in the gas fields in order to keep a careful check on gas wells to determine whether their flow was diminishing or not, while under working conditions. This brought about the invention of the Pitot Tip and Box shown in Fig. 5. In this method, the Box was attached to the pipe line leading from the well and when not in use the tip was withdrawn and the opening plugged with a common pipe plug. Each line to the different wells was fitted with a similar Box and the gauge was carried from one location to another with little inconvenience.

When measuring with this apparatus the regular pipe line was used instead of a 12 foot specially drilled brass tubing of the same size as the line. Although the error was greater than with the perfected Oliphant Pitot Tube, it served its purpose to a high degree of satisfaction.

Pitot Meter Installation and Operation—The best results with the Pitot Tube are obtained where it is especially designed for permanent installation, and when properly built and installed it becomes a scientific instrument of accurate measurement. It is constructed of a carefully made steel tip, having a hole about one-quarter inch in diameter, inserted in the exact center of a seamless drawn brass tube with interior surface polished and gauged to accurate and uniform size throughout its length. The tip is mounted in a saddle in such a manner as to be easily removed for cleaning, and easily reinserted to occupy exactly the previous position. The size of the brass tube used is determined by the quantity of gas to be measured, and is chosen so as to produce a velocity much higher than that in the main pipe lines, in order to produce a high differential or impact pressure reading, thus greatly increasing the accuracy of

GENERAL

the instrument by diminishing the error of observation. Each tube must be calibrated against a standard tube and a coefficient obtained, which, when multiplied by the square root of the product of the differential pressure and the static pressure (in absolute units), will give the flow in unit time.

These high precision tubes are usually installed in batteries of two or more, for obtaining measurements of a wide range of flows, and must have a sufficient run of pipe of the same size as the tube, both ahead and behind them, to avoid eddies and counter currents in the flow. The polished interior surface of the tube, and the high velocity of the gas prevent the formation of deposits and the tube coefficient thus remains constant for a long period. Should any accident occur whereby the tube becomes dented or injured in any way, it is necessary to have it repaired and recalibrated to obtain a new coefficient.

It also should be borne in mind that Pitot Tube observations must be made every fifteen minutes during the twenty-four hours. This requires the services of two men working twelve hour shifts.

The ordinary commercial Pitot Tube should be used with caution, for in spite of its extreme simplicity it is a delicate instrument and should be handled as such. When used in ordinary pipe lines, the velocities encountered may produce differential pressures so small that it is impossible to read them with accuracy, and the interior surface of the pipe may be rough and uneven, a condition that seriously affects the result obtained with the instrument. The internal diameter of commercial pipe is not strictly uniform and is difficult to obtain with exactness, and as this factor enters into the Pitot Tube formula as the square of the value, any percentage of error in the measurement of the diameter is doubled in the effect upon the final result. A further difficulty is presented in the necessity of placing the tube in

the cross section of the pipe at the point of average velocity, which point varies in the different sizes of pipe, and for different conditions of interior surface. A better plan is to place the tip in the center of the pipe and use the coefficient obtained by actual calibration for each size of pipe. If this is done and care is taken to see that the interior of the pipe is free from sediment or dirt, and its diameter where the tip is inserted is accurately obtained, very satisfactory results may be obtained in the field with the Pitot Tube. In all cases, a free run of at least forty feet of pipe of the same size as that in which the tube is inserted must be installed on the inlet side of the tube, and ten feet on the outlet, and there must be no fittings or obstructions nearer to the tube than these distances.

While the Pitot Tube is considered a very accurate measuring instrument, its high cost of installation and the inability to easily transport it from one location to another in the gas field caused it to be displaced by the smaller and more easily moved orifice meter with its self recording differential gauge.

The invention of the recording differential gauge was the direct result of the objectionable high upkeep of the old Pitot Tube, and lack of ability to easily transport the large and cumbersome instrument from one place to another. The recording differential gauge now does the duty formerly required of the employees working double shift, who read the water gauge every fifteen minutes throughout the twenty-four hours and made hand-written reports which had to be sent to the head office daily.

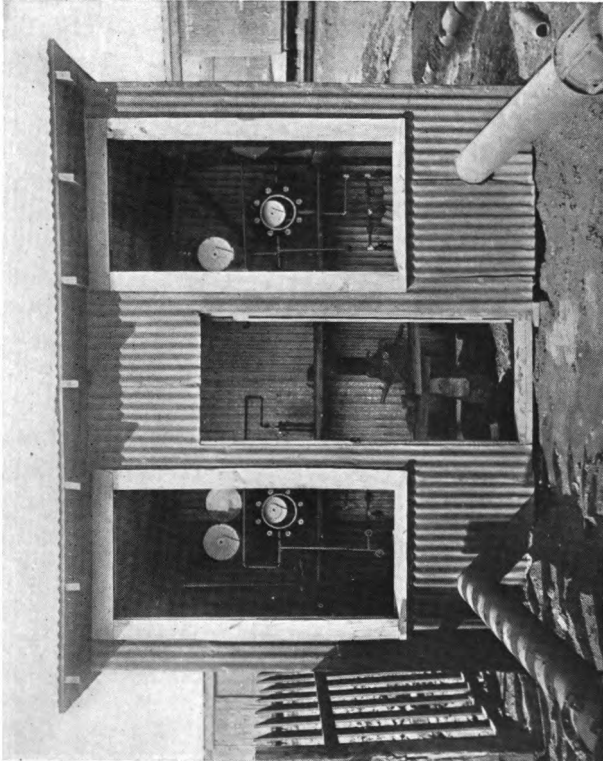
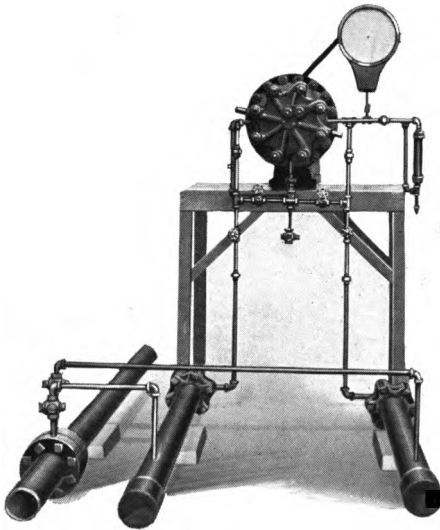

Fig. 6—ORIFICE METER INSTALLATION. "BOMBHELL" TYPE GAUGES



*Fig. 7—ONE OF THE EARLY DESIGNS OF THE RECORDING
DIFFERENTIAL GAUGE AND ORIFICE FLANGE METER
KNOWN AS THE "BOMBSHELL" TYPE*

HISTORY AND USES OF ORIFICE METERS AND DIFFERENTIAL GAUGES*

"In 1910 the demand for a Pitot tube, or meter based on that principle, which could be quickly changed and more easily handled than the heavy, cumbersome Pitot tubes, developed. To meet this need and using the same principle as the Pitot Tube, the Orifice Meter was invented in the fall of 1911, by John G. Pew and H. C. Cooper of Pittsburgh, Pa.

Mr. Walter Abbe, working under the direction of the above named parties, spent approximately six months conducting experiments at the Wilksburg Test Station of the Peoples Natural Gas Co. It was soon discovered that the theoretical formula worked out for the principle of the Pitot Tube, would apply for an Orifice, so that it was then mainly a matter of experiment to determine the shape of Orifice and the manner of making the connections, which would give the most consistent results and smallest variations between the high and low runs. These tests were completed in November 1911, and the first Orifice meter for measuring gas was installed on the lines of the Hope Natural Gas Company, in West Virginia.

The above tests were made at the reducing station of the Peoples Natural Gas Co., where its main lines entering the city of Pittsburgh were brought into one station and from which point the gas was distributed at lower pressures to the various lines feeding the city. It can thus be seen that these tests were run under actual working conditions at a point where any desired pressure from forty to one hundred and sixty pounds could be secured, and any volume up to fifty million feet a day was available for the tests.

From that time on the Orifice meter gradually came into prominence, though there were other gas companies who differed with the Peoples Natural Gas Co., as to the thickness of the Orifice discs and the manner of making connections.

* By J. H. Satterwhite

They decided to run their own experiments. One of the first of these was the United Natural Gas Co., of Oil City, Pa. Mr. Thomas Weymouth, of this company, conducted a large number of experiments and finally decided on the same connections as used by Messrs. Cooper and Pew, but used a thinner disc with a straight edge, instead of the beveled edge as originally used. Mr. Weymouth finished his experiments in the spring of 1913, and later tests and experiments have proven that his formulae and coefficients are correct.

The next company to make their own tests relative to coefficients, was the Wichita Pipe Line Co., now the Empire Gas & Fuel Co. Their first tests were made at Joplin, Mo., where they had an old artificial gas holder to use as a standard basis of measurement. A very interesting article covering these tests and subsequent tests made at Wann, Okla., is to be found in the files of the American Society of Mechanical Engineers, December 1915, under the title of "The Flow of Air Through Thin Plate Orifices," by E. O. Hickstein. See Pages 78 to 98.

These tests were started in August 1913, and completed in the spring of 1914. The Empire Gas & Fuel Co., differed slightly from the methods adopted by the Peoples Natural Gas Co., in that although they adopted the beveled edge disc, they also adopted the connections, now used extensively throughout the Mid-Continent field, of $2\frac{1}{2}$ times the diameter of the pipe on the inlet side of the Orifice disc, and 8 times the diameter of the pipe on the outlet or downstream side of the Orifice disc. Subsequent tests at Erie, Penna., and at several places throughout the Mid-Continent field have proven conclusively that the coefficients adopted for this method of connection are absolutely correct.

There have been during the past four years, quite a few tests that really have no official standing other than that they were check tests, all of which have proven that the original work along these lines was correct, and that it is now

optional to the user as to whether he desires to use flange connection Orifice meters, or meters that use what is called full flow ($2\frac{1}{2}$ and 8 times the diameter) connections. The main thing to be remembered is, that when using the full flow connections the static pressure must be taken from the upstream side of the Orifice, while for flange connections it is taken from the downstream side.

Differential Gauges—After the Peoples Natural Gas Co. had completed their original tests and determined the accuracy and adaptability of the Orifice meter, it was found necessary to develop a gauge that would record the differential or drop in pressure from one side of the Orifice disc to the other. It is this development of the recording differential gauge that forms one of the most interesting and important stages of Orifice meter development of later years.

At the time when the original experiments covering coefficients were completed there was no instrument on the market for recording differential pressure. It was found however, that one of the gauge manufacturers did make a recording gauge that recorded pressure in terms of inches of water. On the night of November 5th, 1911, at a private residence in Pittsburgh, a meeting of several young men interested in this work was held. At this meeting the encased type differential gauge, commonly called the "Bomb Shell" was developed. This consisted of a skeleton constructed common recording pressure gauge, with chart graduated in inches of water pressure, encased within a heavy casting. This casting was slightly larger than the recording gauge and made to stand a high pressure. It had a cover bolted on, and through the cover were two peep holes, through which one could watch the action of the gauge within. From the spring a line leading through the casting was connected to the high or upstream side of the Orifice, which permitted the higher pressure to be exerted on the inside of the spring.

From the low or downstream side of the Orifice another line was connected to the casting, filling same with gas, so that the lower pressure was exerted on the outside of the spring. The spring would then record the difference between the two pressures, which was the differential drop in pressure across the Orifice disc.

This was rather a crude differential gauge, and its weight made it quite a cumbersome affair. It was however, the best that could be secured in the short time allowed, and afterwards proved to be the best gauge of its type, until the mercury float type differential gauge was developed in later years. There are still a large number of "Bomb Shells" in operation in West Virginia and Pennsylvania, and outside of the fact that the springs have to be replaced frequently, they are giving very good satisfaction.

The gauge manufacturers immediately took up the work of designing a differential gauge that would give satisfactory service and eliminate the objectionable features of the "Bomb Shell." They turned out during the next few years quite a few types of differential gauge, using springs, but they all had the same trouble as the "Bomb Shell," namely that it took too many springs to keep them in operation and they were not sensitive enough.

The Bristol Co., of Waterbury, Conn., was the first of the gauge manufacturers to get out a mercury float type differential gauge, and there are a few of these that are now obsolete in the fields. This gauge never gave satisfaction, as it could not be kept adjusted, and besides was constantly losing mercury. Under these conditions it was not as good as the spring type. However, they had the right idea, as has been proven, namely using a mercury seal instead of a spring, and it never has been thoroughly understood why their engineers dropped the gauge at this point and did not perfect it, unless as has been stated, they did not desire to go into the Orifice meter business.

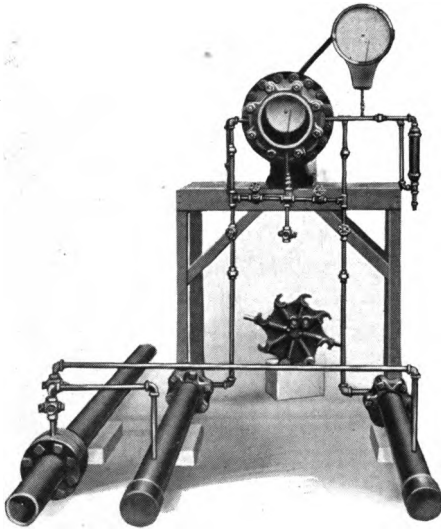

Fig. 8—"BOMBHELL" TYPE DIFFERENTIAL GAUGE. COVER REMOVED. NOTE LARGE PIPE DEADENERS IN GAUGE LINES

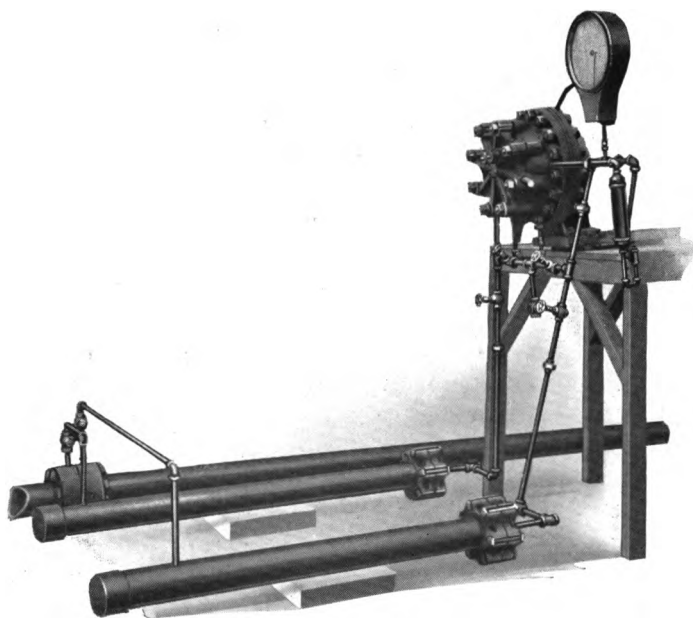

Fig. 9—ANOTHER VIEW OF "BOMBSHELL" TYPE GAUGE

Natural Gas Companies Develop Proper Gauge—The gas companies realized the importance of a high class differential gauge and from two entirely different sources plans were started to develop a mercury float type differential gauge; one in the Mid-Continent fields, and the other in the Ohio fields. From their investigations and plans were developed the two differential gauges that are on the market today. Both of these gauges have undergone a large number of improvements since their invention in 1914 and who can say that there are not a large number of improvements still to come.

Adaptability of Orifice Meter—The Orifice meter is now used for the measurement of coke oven gas, manufactured gas of all kinds, steam, water and oil.

It will be seen from the above that the adaptability of this type of meter for the measurement of both gases and liquids is practically unlimited.

These different uses for which the Orifice meter is adapted simplifies the work of the purchasing agent, especially the purchasing agent who would have to contend with the purchasing of meters for both gases and liquids. By adopting the Orifice meter, all he has to do is to watch his warehouse stock and keep same replenished. If an engineer desires a meter to measure gas, he can go to the warehouse and secure one. If another man desires a meter to measure oil he can go to the warehouse and secure the same kind of meter, which also applies to the man who desires to measure steam. Different coefficients are applied, according to the gas or liquid which they desire to measure, but the apparatus is the same.

It is not altogether the desire for a meter which will give them correct measurement that has caused so many engineers to adopt the Orifice meter, but there is another factor entering into its use that has strongly appealed to them. That is—the Orifice meter will tell them to a large extent exactly

what is taking place in the lines or at their plants. For instance, the meter measuring oil at a refinery, not only tells the engineers how much oil has been used during the past twenty-four hours, but also tells them the rate per hour, also whether their pumper has been keeping his pumps going at a uniform rate of speed, or whether he pumps too much one hour and not enough another hour. It helps them greatly in smoothing out their operations, so that they can secure greater efficiency and better products at a uniform rate of operation. The same idea applies when measuring steam, as the engineer then knows exactly how to handle his boiler room under different and varying loads, and knows how these loads are pro-rated throughout the plant.

Likewise, in the gas business it tells its own story, in that the superintendent will know whether his field men are drawing on his wells at a uniform rate of flow or whether they pull on one well hard for a while, and then ease up and draw on another one heavy for a while. This is especially desirous at this time, when so many of the states in the Middle West have passed laws regulating the percentage of the open flow of a gas well that may be taken in twenty-four hours. It likewise helps the town superintendent in providing daily records enabling him to properly take care of his varying loads. The pipe line superintendent can also tell whether his men are taking proper care of the drips along the line, because a heavy accumulation of gasoline condensate or water in the lines would be shown on the Orifice meter chart by a vibration of the differential pen arm. It can thus be seen that not only does the Orifice meter measure accurately the liquid or gas passing through the pipe line, but also gives its owner a definite record of what is transpiring relative to various operations."

PART TWO

PHYSICAL PROPERTIES OF FLUIDS

The flow of fluids follows the physical laws which were discovered centuries ago. These laws and the properties of fluids which are the basis of the derivation of the simple formula for the flow through an Orifice are explained in detail in the following pages. No attempt is made to explain the problems of thermodynamics, pneumatics, etc., but only to give an outline of those laws leading up to the formula universally used.

Theory of the Constitution of Matter—Physicists have generally adopted the following theory of the constitution of matter. Every body of matter is composed of exceedingly small particles, called molecules, in other words, every body is the sum of its molecules. No two molecules of matter in the universe are in contact with each other. Every molecule of a body is separated from its neighbors, on all sides, by inconceivably small spaces. Every molecule is in quivering motion in its little space, moving back and forth between its neighbors, and rebounding from them. When we heat a body we simply cause the molecules to move more rapidly through their spaces; so they strike harder blows on their neighbors, and usually push them away a very little; hence, the size of the body increases. This theory seems, at first, little more than an extravagant guess. But it shall be found that this theory enables us to account for most of the known phenomena of matter.

States of Matter—For the purposes of subdivision we may say that matter exists in three distinct states, the solid, the liquid, and the gaseous. In addition, however, to states

which fulfill the definitions of a solid, a liquid, or a gas, which we shall give later on, it will be found that there are intermediate states which bridge over the intervals between the solid and the liquid, and the liquid and the gas. As an example of the kind of gradation which exists, we may take the following: steel, lead, wax, cobbler's wax (which will flow like a liquid if allowed sufficient time), water, ether, steam, air, hydrogen. In addition there is the critical state when a substance is to all intents and purposes both a liquid and a gas.

We may define a solid as a portion of matter which is able to support a steady longitudinal stress without lateral support. In contradistinction, a portion of matter which is unable to support a steady longitudinal stress without lateral support is called a fluid.

If we take a solid body, say a lead pencil, then we may apply a deforming force, either of compression or extension, in any direction to the pencil, and there will be a certain amount of strain, either elongation, compression, or bending produced, which will call into play a stress that will be in balance with this force, and this stress will be produced without the body being supported in any way in a direction at right angles to that along which the stress acts. In the case of a fluid, such as water or air, we are unable to exert a stress on it, and hence produce a corresponding strain, unless we supply some constraining boundary which shall prevent the fluid swelling out at right angles to the line of action of the stress.

Fluids, Liquids and Gases—Fluids are divided into liquids and gases. A liquid is a fluid such that when a certain volume is introduced into a vessel of greater volume it only occupies a portion of the vessel equal to its own volume. A gas is a fluid such that if a certain volume is introduced into a vessel, then, whatever the volume of the vessel may be, the gas will distribute itself throughout the vessel.

PHYSICAL PROPERTIES OF FLUIDS

Vapor—Vapor is essentially the same as gas, but the word vapor is conveniently limited to the gaseous state of a body which is liquid or solid at ordinary temperatures, while the term “gas” is applied to those fluids which are in that rarified state at ordinary temperatures.

Vapor and Gas—A vapor is a substance in the gaseous state at any temperature below the critical point. A vapor can be reduced to a liquid by pressure alone, and may exist as a saturated vapor in the presence of its own liquid. A gas is the form which any liquid assumes above its critical temperature, and it cannot be liquefied by pressure alone, but only by combined pressure and cooling. The critical point is the lowest temperature of a gas at which it cannot be liquefied by pressure. The critical point is the line of demarcation between a vapor and a gas. The temperature of the substance at the critical point is the critical temperature. The pressure which at the critical temperature just suffices to condense the gas to the liquid form is called the critical pressure.

Table 1
CRITICAL TEMPERATURES AND PRESSURES
OF VARIOUS GASES

Gases or Vapors	Chemical Formula	Critical Temp. deg. fahr.	Critical Pressure, lb. per sq. in. abs.
Water	H ₂ O	689	2940
Ammonia	NH ₃	266	1691
Acetylene	C ₂ H ₂	99	
Carbon Dioxide	CO ₂	88	1103
Ethylene	C ₂ H ₄	50	760
Methane	CH ₄	-115	807
Oxygen	O ₂	-182	747
Argon	A ₂	-186	744
Carbon Monoxide	CO	-219	522
Air	..	-220	573
Nitrogen	N ₂	-231	515
Hydrogen	H ₂	-389	294

Gravitation—That attraction which is exerted on all matter, at all distances, is called gravitation. Gravitation is universal, that is, every molecule of matter attracts every other molecule of matter in the universe. The whole force with which two bodies attract one another is the sum of the attractions of their molecules, and depends upon the number of molecules the two bodies collectively contain, the mass of each molecule, and the distance between the bodies. What is understood by the weight of a body is the mutual attraction between it and the earth.

The force of gravity varies with the distance from the center. Observations made in various ways show that the force of gravity varies over the surface of the earth. Now it is found that the nearer an object without the earth's surface is to the center of the earth, the greater is the force of gravity. The polar diameter of the earth is about 26 miles less than its equatorial diameter, and consequently, the distance from the center to the surface at the poles is 13 miles less than to the surface at the equator. This considerable difference in distance from the center occasions an appreciable difference between the weight of a body (having any considerable mass) at the equator and at the poles; and, since the distance of the surface from the center constantly increases as we go from the poles toward the equator, the weight of all objects transported from the poles toward the equator constantly diminishes.

Fluid Pressure—With the exception of the phenomena of capillarity and those occasioned by difference in compressibility and expansibility, liquids and gases are governed by the same laws.

We are placed on the borders of two oceans. A watery ocean borders our land; an aerial ocean, which is called the atmosphere, surrounds us. Every molecule, in both the gaseous and liquid oceans, is drawn toward the earth's center



Fig. 10—MEASURING STATION



Fig. 11—ORIFICE METER ON LARGE GAS MAIN

by gravity. This gives to both fluids a downward pressure upon everything upon which they rest.

The gravitating power of liquids is everywhere apparent, as in the fall of drops of rain, the descent of mountain streams, the power of falling water to propel machinery, and the weight of water in a bucket. The downward pressure of air is indicated by a barometer.

Compressibility and Expansibility of Gases—The increase of pressure attending the increase in depth, in both liquids and gases, is readily explained by the fact that the lower layers of fluids sustain the weight of all the layers above. Consequently, if the body of fluid is of uniform density, as is very nearly the case in liquids, the pressure will increase in nearly the same ratio as the depth increases. But the aerial ocean is far from being of uniform density, in consequence of the extreme compressibility of gaseous matter. The contrast between water and air, in this respect, may be seen in the fact that water, subjected to a pressure of one atmosphere, contracts .0000457 of its volume; under the same circumstances, air contracts one-half. For most practical purposes, we may regard the density of water at all depths as uniform, while it is far otherwise in large masses of gases.

The pressure at different depths in liquids may be illustrated by piling several bricks one on another, when the pressure that different bricks sustain varies directly with their depths below the upper surface of the pile. On the other hand, pressure of gases at different depths may be illustrated by piling fleeces of wool one on another. Since the volume of each successive fleece varies with the weight it bears, the pressure which different fleeces sustain are not proportional to their respective depths below the upper surface of the pile. At twice the depth, there would be much more than twice the pressure, because the lower point would sustain more than twice the number of fleeces.

Closely allied to compressibility is the elasticity of gases, or their power to recover their former volume after compression. The elasticity of all fluids is perfect. By this is meant, that the force exerted in expansion is always equal to the force used in compression; and that, however much a fluid is compressed, it will always completely regain its former bulk when the pressure is removed. Liquids are perfectly elastic; but, inasmuch as they are perceptibly compressed only under tremendous pressure, they are regarded as practically incompressible and so it is rarely necessary to consider their elasticity. It has already been stated that matter in a gaseous state expands indefinitely, unless restrained by external force. The atmosphere is confined to the earth by the force of gravity.

Expansive Power of Gases—The property of gases which distinguishes them from other fluids is that a given mass of gas, when introduced into a closed vessel, always exactly fills the vessel, whatever its volume. Thus if we have two equal closed vessels connected together by a tube which can be closed by means of a tap, and one of these vessels is filled with a gas, say air at the ordinary pressure, while the other does not contain any matter, or, in other words, has a vacuum inside, then, on opening the tap, the air immediately expands and rushes into the second vessel, till finally there is the same quantity of gas in each vessel. By again closing the tap and exhausting the air from one of the vessels by means of an air pump, and then opening the tap, the remaining gas again expands and fills the two vessels. This operation may be repeated indefinitely, and in every case the gas left in the one vessel will, when the tap is opened, expand and fill the two vessels. This experiment illustrates the expansive power of gases.

Since the gas enclosed in a vessel always expands and completely fills the vessel, even if this latter is increased in volume, it follows that the gas must exert a pressure on the

PHYSICAL PROPERTIES OF FLUIDS

inside of the containing vessel. That this is so can be shown by enclosing some air at ordinary atmospheric pressure in a thin glass flask, and then removing the air from outside the flask by placing it beneath the receiver of an air pump, when, unless the flask is fairly strong, the pressure exerted by the air inside the flask will be sufficient to burst the flask. The reason that the flask does not burst before the air surrounding it is removed, is that the air surrounding the flask presses on the outside of the flask and counteracts the effect of the pressure of the enclosed air on the inside. When the air outside is removed by means of the pump there is no pressure exerted on the outside, and the flask may not be strong enough to withstand the inside pressure.

Pascal's Law—An exterior pressure applied to a fluid is transmitted equally in all directions, or the pressure per unit of area exercised inward upon a mass of fluid is transmitted undiminished in all directions, and acts with the same force upon all surfaces in a direction at right angles to those surfaces. Hence, the pressure applied to any area of a confined fluid is transmitted to every other equal area through all

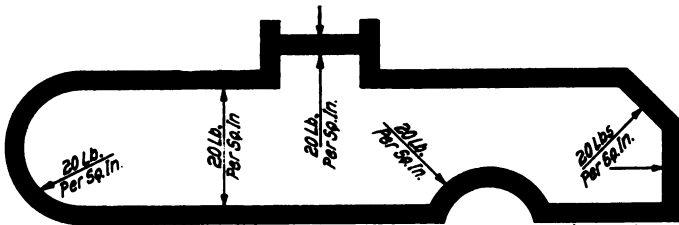

Fig. 12—DIAGRAM ILLUSTRATING PASCAL'S LAW

the fluid to the walls of the containing chamber without diminution, as shown in the diagram above. According to this law, the gas pressures in the various parts of a "continuous and connected reservoir" must be equal. The total pressure acting upon any definite portion of the surface is

equal to the pressure exerted by the head of fluid itself plus the effect of the exterior pressure, which is transmitted by the fluid.

PRESSURE AND LIQUID HEAD

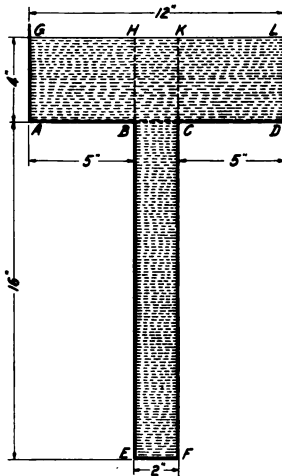

Fig. 13

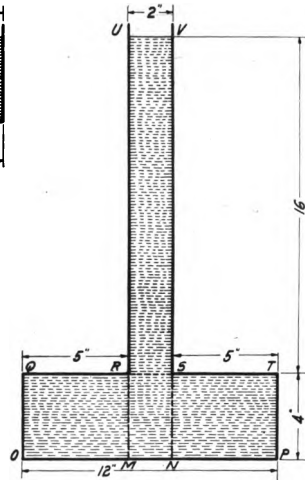

Fig. 14

The fact that the pressure of a liquid depends only upon the head may be illustrated by the above diagrams. Assuming the above vessels as one inch wide and filled with water to the elevations indicated, the total pressure acting on the surface **A** to **D** is 48 cubic inches of water or 4 cubic inches of water on each square inch. Since **BC** is 2 inches the total pressure acting on **BC** is 2×4 or 8 cubic inches. The total pressure acting on **EF** is equal to the pressure at **BC** plus the weight of the column of water **BE**. Column **BEFC** contains 32 cubic inches. Therefore the total pressure on **EF** equals $32 + 8$ or 40 cubic inches. Since **EF** is 2 square inches in area, the pressure per square inch is 20 cubic inches of water, or a pressure equal to 20 inches head of water which is the height of the surface above **EF**.

PHYSICAL PROPERTIES OF FLUIDS

In Fig. 14 the pressure acting on **RS** is 16 inches head of water. Since this pressure is transmitted equally in all directions the pressure acting on each square inch from **Q** to **T** is also equal to the weight of 16 cubic inches of water. If this fact is not true and the pressure near **T** is less than at **S** then the water would flow from **S** toward **T**. Since these points are on the same level and the water is not in motion the pressure at each point must be equal to the pressure at the other point. This pressure acts upward on the container from **Q** to **R** from **S** to **T** as well as downward on the liquid at this level. Therefore the total pressure from **Q** to **T** is 16×12 or a weight of 192 cubic inches of water. The total pressure on surface **OP** is equal to the pressure at **QT** plus the weight of the water between **QT** and **OP** as the sides **QO** and **TP** are vertical. This latter volume equals 4×12 or 48 cubic inches. Therefore the total pressure on **OP** equals $48 + 192$ or 240 cubic inches of water on 12 square inches of surface or weight of 20 cubic inches of water per square inch. The pressure acting on this surface is 20 inches of water head. Therefore, liquid pressure depends only on the head of liquid and density and not on total area. The expression "feet head of liquid" is equivalent to a pressure per inch equal to the weight of a column of liquid, one square inch in area of a height equal to the feet head. If gasoline is used as a liquid the head in inches of gasoline on each area would be the same as for water but the pressure per square inch would be less depending on the relative densities of gasoline and water.

We conclude, therefore, that the total pressure on the bottom of a vessel depends on the depth, the area of the bottom, and the density of the liquid, and is independent of the shape of the vessel and the quantity of liquid. The important fact that the pressure on the bottom does not depend on the shape of the vessel is often called the hydrostatic paradox, because though true, it seems at first absurd.

The pressure due to gravity on any portion of the bottom of a vessel is equal to the weight of a column of that liquid whose base is the area of that portion of the bottom pressed upon, and whose height is the greatest depth of the liquid in the vessel.

Evidently the lateral pressure at any point of the side of a vessel depends upon the depth of that point; and, as depth at different points of a side varies, hence, to find the pressure upon any portion of a side of a vessel, we find the weight of a column of water whose base is the area of that portion of the side, and whose height is the average depth of that portion. Thus, we compute the total pressure on the side **UVRS** of the vessel (Fig. 14), by multiplying the area of the side 32 square inches (dimensions, 16×2 inches), by the depth to the middle point, 8 inches. The total pressure is equal to the weight of 256 cubic inches of water.

From the preceding paragraphs it is evident that the head of fluid acting on a surface may be expressed in terms of head of any other fluid or in terms of pressure per square inch, also that the pressure per square inch may be expressed in terms of liquid head.

Since the weight of water is 62.355 pounds per cubic foot, a column of water one foot high and one square foot in area exerts a pressure of 62.355 pounds on the square foot of surface, 62.355 lb. per square foot, or 0.43302 pounds per square inch. Therefore, a column of water one foot high and one square inch in area is equivalent to a pressure of .43302 pounds per square inch, and one pound per square inch equals 2.3094 feet water head, or one pound per square inch equals 27.71 inches of water. One inch of water head exerts pressure of .03609 pounds per square inch. Since the average atmospheric pressure of the gas fields is 14.4 pounds per square inch, it may be expressed as equal to (14.4×2.3094) or 33.3 feet water head. It also may be expressed as 399 $(14.4 \times 27.71 = 399)$ inches water head. In the same manner one inch of

PHYSICAL PROPERTIES OF FLUIDS

Table 2—PRESSURE EQUIVALENTS

Ounces	In. Water	In. Mercury	In. Mercury	Ounces	In. Water	In. Water	In. Mercury	Ounces
.25	.43	.032	1.	7.85	13.60	.25	.018	.144
.50	.87	.064	1.5	11.78	20.40	.50	.037	.259
.75	1.30	.095	2.	15.71	27.20	.75	.055	.433
1.	1.73	.127	2.5	1.23 lb.	34.00	1.	.074	.577
2.	3.46	.26	3.	1.47	40.80	2.	.147	1.15
3.	5.19	.38	3.5	1.72	47.60	3.	.22	1.73
4.	6.92	.51	4.	1.96	54.40	4.	.29	2.31
5.	8.65	.64	4.5	2.21	61.20	5.	.37	2.89
6.	10.38	.77	5.	2.45	68.00	6.	.44	3.46
7.	12.11	.89	5.5	2.74	74.80	7.	.51	4.04
8.	13.85	1.02	6.	2.94	81.60	8.	.59	4.62
9.	15.58	1.15	6.5	3.19	88.40	9.	.66	5.20
10.	17.31	1.27	7.	3.44	95.20	10.	.74	5.77
11.	19.05	1.40	7.5	3.68	102.00	11.	.81	6.35
12.	20.78	1.53	8.	3.93	108.80	12.	.88	6.93
13.	22.51	1.66	8.5	4.17	115.61	13.	.96	7.51
14.	24.24	1.78	9.	4.42	122.41	14.	1.03	8.08
15.	25.97	1.91	9.5	4.66	129.21	15.	1.10	8.66
16 or 1 lb.	27.71	2.04	10.	4.91	136.01	16.	1.18	9.24
1 lb. 1oz.	29.44	2.16	10.5	5.15	142.81	17.	1.25	9.82
" 2 "	31.17	2.29	11.	5.40	149.61	18.	1.32	10.39
" 3 "	32.90	2.42	11.5	5.64	156.41	19.	1.40	10.97
" 4 "	34.63	2.55	12.	5.89	163.21	20.	1.47	11.55
" 5 "	36.36	2.67	12.5	6.14	170.01	21.	1.54	12.13
" 6 "	38.09	2.80	13.	6.38	176.81	22.	1.62	12.70
" 7 "	39.82	2.93	13.5	6.63	183.61	23.	1.69	13.28
" 8 "	41.56	3.06	14.	6.87	190.41	24.	1.76	13.86
" 9 "	43.29	3.18	14.5	7.12	197.21	25.	1.84	14.44
" 10 "	45.02	3.31	15.	7.36	204.01	26.	1.91	15.01
" 11 "	46.76	3.44	15.5	7.61	210.81	27.	1.99	15.59
" 12 "	48.49	3.57	16.	7.85	217.61	27.71	2.04	16 or 1 lb.
" 13 "	50.22	3.69	16.5	8.10	224.41	29.	2.13	1.05 lb.
" 14 "	51.95	3.82	17.	8.34	231.21	30.	2.21	1.08 "
" 15 "	53.68	3.95	17.5	8.59	238.01	31.	2.28	1.12 "
2 lb.	55.42	4.07	18.	8.83	244.81	32.	2.35	1.15 "
2 lb. 1oz.	57.15	4.20	18.5	9.08	251.61	33.	2.43	1.19 "
" 2 "	58.88	4.33	19.	9.33	258.41	34.	2.50	1.23 "
" 3 "	60.62	4.46	19.5	9.57	265.21	35.	2.57	1.26 "
" 4 "	62.35	4.59	20.	9.82	272.01	36.	2.65	1.30 "
" 5 "	64.08	4.71	20.5	10.06	278.81	37.	2.72	1.34 "
" 6 "	65.81	4.84	21.	10.31	285.61	38.	2.79	1.37 "
" 7 "	67.54	4.97	21.5	10.55	292.41	39.	2.87	1.41 "
" 8 "	69.27	5.10	22.	10.80	299.21	40.	2.94	1.44 "
" 9 "	71.01	5.22	22.5	11.04	306.01	41.	3.01	1.48 "
" 10 "	72.74	5.35	23.	11.29	312.81	42.	3.09	1.52 "
" 11 "	74.47	5.48	23.5	11.53	319.61	43.	3.16	1.55 "
" 12 "	76.20	5.60	24.	11.78	326.41	44.	3.24	1.59 "
" 13 "	77.93	5.73	24.5	12.02	333.21	45.	3.31	1.62 "
" 14 "	79.67	5.86	25.	12.27	340.02	46.	3.38	1.66 "
" 15 "	81.40	5.99	25.5	12.52	346.82	47.	3.46	1.70 "
3 lb.	83.13	6.11	26.	12.76	353.62	48.	3.53	1.73 "
" 1oz.	84.86	6.24	26.5	13.01	360.42	49.	3.60	1.77 "
" 2 "	86.59	6.37	27.	13.25	367.22	50.	3.68	1.80 "
" 3 "	88.33	6.50	27.5	13.50	374.02	51.	3.75	1.84 "
" 4 "	90.06	6.62	28.	13.74	380.82	52.	3.82	1.88 "
" 5 "	91.79	6.75	28.5	13.99	387.62	53.	3.90	1.91 "
" 6 "	93.52	6.88	29.	14.23	394.42	54.	3.97	1.95 "
" 7 "	95.25	7.01	29.5	14.48	401.22	55.42	4.07	2. lb.
" 8 "	96.98	7.13	30.	14.72	408.02			

mercury is equivalent to .4908 pounds per square inch as one cubic inch of mercury weighs .4908 pounds. One inch of mercury is equal to $\frac{.4908}{.03609}$ or 13.6 inches of water.

Pressure Equivalents.

One inch of mercury = .4908 lb. per square inch.

One inch of mercury = 13.6 inches of water.

One foot of water, 62 deg. fahr. = 62.355 lb. per square foot.

One foot of water, 62 deg. fahr. = .43302 lb. per square inch.

One inch of water, 62 deg. fahr. = .03609 lb. per square inch.

One inch of water, 62 deg. fahr. = .07353 inches of mercury.

One pound per square inch = 2.0375 inches of mercury.

One pound per square inch = 27.712 inches of water.

One pound per square inch = 2.3094 feet of water.

ATMOSPHERIC PRESSURE

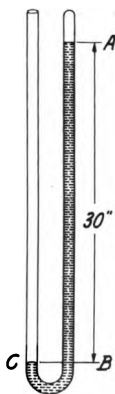

Fig. 15

If the closed end of the U tube, (Fig. 15) having a bore one square inch in area, is filled with mercury, and then inverted; the mercury in the closed arm will sink to A, and will rise in the open arm to C. At sea level the surface A is 30 inches higher than the surface C. This can be accounted for

only by the atmospheric pressure. The column of mercury **BA**, containing 30 cu. inches, is an exact counterpoise for a column of air of the same area extending from **C** to the upper limit of the atmospheric ocean, an unknown height.

The weight of the 30 cu. inches of mercury in the column **BA** is 14.7 lb., which is the weight of a column of air of one square inch section, extending from the surface of the sea to the upper limit of the atmosphere. But gravity causes equal pressure in all directions. At the level of the sea, all bodies are pressed upon in all directions by the atmosphere, with a force of about 14.7 lb. per square inch, over one ton per square foot. Regardless of the size of the bore of the tube the pressures per square inch would be the same, and as liquid head is independent of the shape of the container, the head would be the same for any shape of tube.

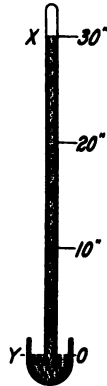

Fig. 16

Barometer—Fig. 16 represents another form of apparatus which is more commonly used for ascertaining atmospheric pressure. It consists of a straight glass tube about 36 inches long, closed at one end, and filled with mercury. When this tube is inverted, the open end having been covered with a finger and plunged into an open cup of mercury, and the

finger withdrawn, the mercury in the tube will sink until it balances the atmospheric pressure. This experiment was devised by Torricelli, an Italian. The apparatus is called a barometer. The empty space above the mercury in the tube is called a Torricellian vacuum. If water is used in a very long tube instead of mercury the height **XY** would be about 34 feet or 13.6 times as high as for mercury at sea level.

If the barometer is carried up a mountain, it is found that the mercury constantly falls as the ascent increases. This shows that the pressure is less near the top of the aerial ocean than near its bottom. It is found that the pressure increases very rapidly upon descending when near the bottom.

The density of the air at a height of 3 miles is but little more than $\frac{1}{2}$ the density at the sea level; at 6 miles, $\frac{1}{4}$; at 9 miles, $\frac{1}{8}$; at 15 miles, $\frac{1}{30}$; at 35 miles it is calculated to be only $\frac{1}{80000}$, so that the greatest part of the atmosphere must be within that distance of the surface of the earth. On the other hand, if an opening could be made in the earth, 35 miles in depth below the sea level, it is calculated that the density of the air at the bottom would be 1,000 times greater than at the sea level, so that water would float in it.

The average height of mercury in the vacuum column above the mercury varies with the altitude of the places and in most of the gas fields is about 29.34 inches which is equal to 14.4 pounds per square inch ($29.34 \times .4908 = 14.4$).

Absolute Pressure—If several glass tubes of various areas, sealed at one end are filled with the mercury, the open ends immersed in a deep bowl of mercury (as in Fig. 16) and the sealed ends lifted above the mercury, the tubes will remain filled with mercury until the sealed ends are lifted to a certain level above the surface of the mercury, before a vacant space will be formed, after which any additional elevation of the tubes will fail to increase the height of the mercury in the tubes above the surface of the mercury in the

bowl. The elevation of the mercury in the columns then indicates the atmospheric pressure as the vacant space above the mercury is practically a vacuum. If the whole apparatus including the bowl is then placed in a glass container connected with a vacuum pump and the air is pumped from the container, the mercury in the columns will fall until the air in the container is exhausted when the levels of the mercury in the columns will nearly reach the level of the mercury in the bowl. Due to leakage etc. it will never be possible to obtain a condition when the surfaces will be on the same level. The condition when the surfaces would be level is the entire absence of pressure on the outside of the tubes, the perfect vacuum or the absolute zero of pressure. This point is called the zero of absolute pressure. See Fig. 20.

The zero point of absolute pressure is a perfect vacuum. Like the zero of absolute temperature, it does not exist except theoretically. To express pressures in absolute units the gauge pressure must be added to the atmospheric pressure. The solution of all problems in gas measurement is greatly simplified by expressing all pressures in absolute units. To express pressures in absolute units the atmospheric pressure must be added to the gauge pressure. For example if the gauge pressure is 10 lb. per square inch and the atmospheric pressure is 14.4 lb., the absolute pressure is $(10.0+14.4)$ or 24.4 lb. per square inch. See Fig. 20. Likewise, a line pressure of 20 inches of mercury is equal to an absolute pressure of $(20+29.34)$ or 49.34 inches of mercury, where the atmospheric pressure is 29.34 inches of mercury.

Atmospheric Pressure of Gas Fields—Some years ago Mr. F. H. Oliphant, at that time of the United States Geological Survey, considered as a basis of natural gas measurement a pressure of 14.65 pounds per square inch absolute, and a temperature of 60 deg. fahr., and since then it has become customary for natural gas men to refer their gas measurements to this basis. A pressure of 14.65 pounds per

square inch is 4 ounces above the assumed atmospheric pressure of 14.4 pounds per square inch, the latter being the average at about the elevation of the Great Lakes, which elevation was considered as fairly representing that of most gas fields.

Pressure Gauges—The pressure acting upon, or exerted by fluids is expressed usually in pounds per square inch, inches of mercury, inches of water and feet head of fluid. It is indicated by spring gauges, siphon gauges or U tubes, and sometimes by ordinary vertical columns of liquids.

The ordinary gauge spring is usually made of light hollow brass tubing, one end sealed, coiled in form of a horseshoe or around a circular rod, the open end being fixed to suitable appliances for connections to pipes, etc., in which is contained the fluid whose pressure is desired, the closed end being connected to an indicating pointer or pen arm either directly or by means of levers. When the pressure on the inside of the tube is the same as on the outside, the pointer will retain a fixed zero position but as pressure on the inside increases and becomes greater than the outside pressure the tube expands and tends to straighten the coil causing the arm attached to the sealed end to rotate by equal distances for equal increases in pressure. Thus a spring which is set at zero with the atmospheric pressure at sea level acting on the inside and outside will retain the same zero position on top of Pike's Peak when open to the atmosphere. If the gauge is placed in a tight container under pressure with the same pressure on the inside and outside of the spring, the pen will still retain its zero position. Therefore, a spring gauge is a differential pressure gauge, that is, it indicates a difference in pressure. This difference is usually above and sometimes below atmospheric pressure. The pressure above atmospheric pressure is generally expressed in pounds per square inch and below atmospheric pressure in inches of mercury vacuum. Gauges are marked to indicate pressures

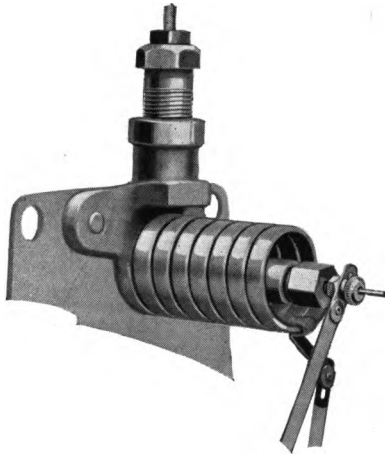

Fig. 17—PRESSURE SPRING. STUFFING BOX OF DIFFERENTIAL GAUGE SHAFT EXTENDING THROUGH CENTER OF SPRING

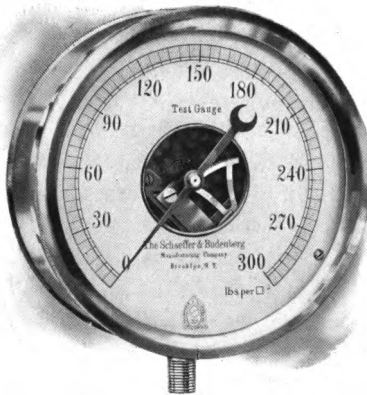

Fig. 18—PRESSURE GAUGE USED FOR TESTING

in various units, such as pounds per square inch, ounces per square inch, inches of water, feet of water, etc.

When a tap is made in a line containing liquid under pressure and a vertical tube is attached to the line the liquid will rise in the tube a certain height depending upon the pressure and the weight of the fluid per unit volume. The height will increase with the pressure. Thus, if the pressure in a water line is ten pounds; that is, ten pounds per square inch greater than the atmosphere, the water will rise 277.1 inches (23.09 feet) in the tube.

For small differences of pressure a glass U gauge is used. Various liquids are used depending upon the range of the gauge and character of fluid whose pressure is to be determined. The pressure difference is the difference of the surfaces of the liquids in the columns of the U tube. If mercury is used in the gauge and the tube C is connected to the container of fluid with D open to the atmosphere the pressure in the container is m inches of mercury greater than the atmosphere. If this tube is connected across an orifice in which a liquid is flowing, for example, water, and each column and connecting lines D and C are filled with water above the mercury, the difference in height of the surfaces of the mercury does not represent the true difference in pressure due to the fact that difference in levels m is partially offset by a column of water, m inches high, in the opposite leg A. Therefore, the total difference in pressure is equal to m inches of mercury minus m inches of water and since each inch of water is equal to .0735 inches of mercury, the pressure differential is $m - .0735 m$ or $0.9265 m$ inches of mercury. In the case of gases the fact is that the difference in liquid levels in the U tube is also offset by a column of m inches of air, but air is so light when compared with liquids that the effect is entirely disregarded.

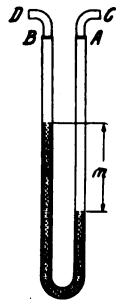

Fig. 19

PHYSICAL PROPERTIES OF FLUIDS

Static Pressure—In orifice meter data the line pressure above the atmosphere is usually known as the static pressure or standing pressure, to distinguish this pressure from the differential pressure which is a pressure difference due to flow.

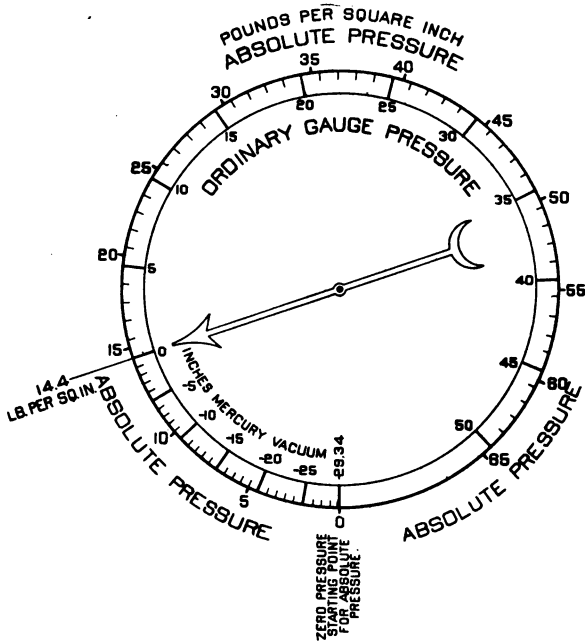

Fig. 20

Vacuum—Ordinary use of this term means merely a partial diminution of pressure below the normal atmospheric pressure or zero gauge pressure. This is the engineering conception of the term as used in this book. The maximum degree attainable with ordinary engineering appliances is about 14 pounds below atmospheric. One of the best examples of vacuum is an incandescent light bulb. In breaking off the tip after placing under water, the bulb is nearly

filled with water because the water is under the pressure of the atmosphere, and the interior of bulb, prior to breaking, was under a minus pressure or less than atmospheric. Vacuum is usually expressed in inches of mercury. Reference to Fig. 20 shows that vacuum is indicated on a gauge in the reverse direction from the pressure. One inch mercury vacuum is equal to -0.4908 lb. per sq. in. Therefore, the absolute pressure corresponding to mercury vacuum equals $14.4 - .4908 \times$ (inches of mercury vacuum) when the atmospheric pressure is 14.4 lb. per sq. in.

Table 3

Based on Atmospheric Pressure of 14.4 lb.

Gauge Pressure lb. per sq. in.	Absolute Pres- sure lb. per sq. in.	Vacuum Inches of mercury	Absolute Pres- sure lb. per sq. in.
50	64.4	1	13.91
10	24.4	5	11.95
1	15.4	10	9.49
0.25	14.65	20	4.58

Referring to Fig. 21 in which there are two U gauges, if the closed column **B** of gauge **A** is filled with mercury and the gauge is inverted, then gauge **A** will indicate the pressure of the atmosphere as explained on Page 32. Assume gauge **C** is an ordinary siphon gauge in which mercury is added until the surfaces of the mercury rest at point **E**, column **D** being open to the atmosphere, and columns **F** and **G** of the two gauges being connected to the same vacuum pump. When the line leading to the vacuum pump is open to the atmosphere the difference in height of mercury at gauge **A** will indicate the atmospheric pressure. The elevation of the mercury in the columns of gauge **C** will be the same, indicating that the pressures on columns **G** and **D** are equal. As the vacuum is being placed on the columns **F** and **G** thereby removing the air from each of these columns

the mercury will fall in columns **B** and **D** and rise in columns **F** and **G**, for the reason that the pressures acting on columns **F** and **G** become less than the atmospheric pressure. The difference in height m of the surfaces of the mercury in the columns of gauge **A**, will then indicate the absolute pressure in inches of mercury acting on the vacuum line. The

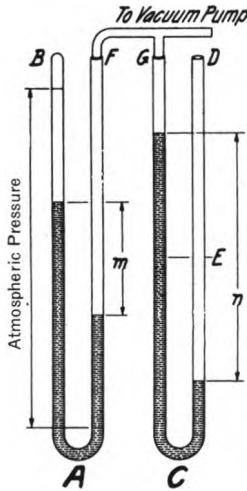

Fig. 21

difference in height of the surfaces of the mercury in the columns of gauge **C** will indicate the inches of mercury vacuum n exerted by the vacuum pump. As the vacuum is increased and if it were possible to entirely remove the air from columns **F** and **G**, thereby eliminating all pressure, the elevation of the surfaces of the mercury in columns of gauge **A** will be on the same level as the pressure acting on each column is zero. The difference in height of the surfaces of mercury in gauge **C** would indicate the atmospheric pressure for the reason that there is no pressure whatever in column **G** whereas the atmosphere acts on surface of the mercury in column **D**.

PHYSICAL PROPERTIES OF FLUIDS

This arrangement will also illustrate the fact that the inches of mercury vacuum when expressed as absolute pressure, is dependent upon the atmospheric pressure. If the atmospheric pressure decreases, the difference in height at gauge **A** will decrease when the line leading to the vacuum pump is open to the atmosphere, and the greatest difference in height of surfaces of the mercury in gauge **C** when connected to the pump can never exceed the difference in elevations of the mercury at gauge **A** when column **F** is open to the atmosphere, providing the atmospheric pressure remains the same. So consequently it is impossible to obtain a greater number of inches of mercury vacuum than the atmospheric pressure expressed in inches of mercury.

As an example, we will assume that when the apparatus is open to the atmosphere that gauge **A** indicates an atmospheric pressure of 30 inches of mercury. Gauge **C** will then indicate 0 inches of mercury. If a vacuum of 20 inches of mercury is placed on the line by the vacuum pump the mercury in column **D** will fall and in column **G** will rise until the difference n in height of the surfaces is 20 inches. At the same time, mercury in column **B** will fall and **F** will rise until the difference in height is 10 inches. So therefore, at any condition of vacuum the sum of the inches of mercury differentials of gauge **A** and gauge **C** will be equal to the atmospheric pressure. (10 inches + 20 inches = 30 inches).

If the atmospheric pressure is only 25 inches of mercury and 20 inches of mercury vacuum is being placed on the line by the vacuum pump the difference in height at gauge **C** will be 20 inches and at gauge **A**, 5 inches, and in this case the sum of these pressures indicate the atmospheric pressure (20 + 5 = 25.) Therefore, the absolute pressure which is represented by gauge **A** is equal to the atmospheric pressure minus the vacuum expressed in same units. Assume the atmospheric pressure is 14.4 lb. per square inch, 20 inches of mercury vacuum represents 9.8 lb. per square inch vac-

Table 4
VACUUM—ABSOLUTE PRESSURE

Inches Mercury Vacuum	Absolute Pressure			
	Based on Atmospheric Pressure 14.4 lb.		Based on Atmospheric Pressure 14.7 lb.	
	Inches of Mercury	Pounds per Sq. In.	Inches of Mercury	Pounds per Sq. In.
0	29.34	14.400	29.95	14.700
1	28.34	13.909	28.95	14.209
2	27.34	13.418	27.95	13.718
3	26.34	12.928	26.95	13.228
4	25.34	12.437	25.95	12.737
5	24.34	11.946	24.95	12.246
6	23.34	11.455	23.95	11.755
7	22.34	10.964	22.95	11.264
8	21.34	10.474	21.95	10.774
9	20.34	9.983	20.95	10.283
10	19.34	9.492	19.95	9.792
11	18.34	9.001	18.95	9.301
12	17.34	8.510	17.95	8.810
13	16.34	8.020	16.95	8.320
14	15.34	7.529	15.95	7.829
15	14.34	7.038	14.95	7.338
16	13.34	6.547	13.95	6.847
17	12.34	6.056	12.95	6.356
18	11.34	5.566	11.95	5.866
19	10.34	5.075	10.95	5.375
20	9.34	4.584	9.95	4.884
21	8.34	4.093	8.95	4.393
22	7.34	3.602	7.95	3.902
23	6.34	3.112	6.95	3.412
24	5.34	2.621	5.95	2.921
25	4.34	2.130	4.95	2.430
26	3.34	1.639	3.95	1.939
27	2.34	1.148	2.95	1.448
28	1.34	0.6576	1.95	0.9576
29	0.34	0.1668	0.95	0.4668

uum, therefore, the absolute pressure is equal to 4.6 lb. per square inch ($14.4 - 9.8 = 4.6$). If these pressures are expressed in inches of mercury, 14.4 lb. is 29.3 inches of mercury, then 20 inches of vacuum represents 9.3 inches mercury absolute pressure ($29.3 - 20 = 9.3$). 9.3 inches mercury absolute equals 4.6 lb. per square inch absolute ($9.3 \times .4908 = 4.6$).

A vacuum will cause a spring to coil or rotate in the opposite direction from the motion occasioned by the pressure. Mercury vacuum is expressed in inches of mercury below the atmospheric pressure whereas absolute pressure is sometimes expressed in inches of mercury above the absolute vacuum so that the absolute pressure of a fluid under a vacuum is equal to the atmospheric pressure minus the vacuum. For example, if the atmospheric pressure is 29.4 and fluid is under 27 inches vacuum the absolute pressure of the fluid is 2.4 inches of mercury or 1.2 lb. per square inch.

Pressure Base—Under the caption of all orifice tables in this book a Pressure Base p_b is specified. The calculations for most of the tables were made by adding this Base to 14.4 lb. the average atmospheric pressure, thus a 4 oz. base is equivalent to 14.4 lb. plus 0.25 lb. or 14.65 lb. per square inch absolute pressure. In adding the pressure base to the atmospheric pressure both quantities must be expressed in pounds per square inch.

In the gas business a Pressure Base is specified and this pressure is the basis of measurement to which all gas volumes shall be calculated. Thus, a cubic foot of gas at 29.8 lb. absolute, equals 2 cubic feet at 14.9 lb. or at 8 oz. above an atmospheric pressure of 14.4 lb. per square inch.

VELOCITY

All matter is in motion. There is no such thing as absolute rest in the universe. There is no use for the word rest, except to indicate, with reference to each other, the conditions of objects that are moving in the same direction

and with the same velocity. For example, the cars and engine of a train running at a speed of 30 miles an hour, are at rest with reference to each other. The phrase "at rest" can only be used in an extremely limited sense, and in common language refers only to the condition of an object with reference to that on which it stands, as a car, deck of a ship, or surface of the earth. It is only by putting entirely out of mind the motions of the earth that we can speak of any terrestrial object as being at rest.

Not only is there motion of mass as a whole, or visible mechanical motion, but there is a motion of the molecules within the mass, an invisible molecular motion. We cannot see the movements of the molecules of steam, but we know that they exist by their great power, manifested in moving machinery.

Uniform and varied motion—All motion takes time; hence the term velocity, which refers to the space traversed in a unit of time. Motion may be uniform or varied; uniform, when an object traverses successively equal spaces in all equal intervals of time; varied, when unequal spaces are traversed in any equal intervals of time. Varied motion may be accelerated or retarded; accelerated, when the spaces traversed increase at each successive interval of time; retarded, when they diminish. The motion of a train of cars, in starting from a station is at first accelerated, afterwards tolerably uniform, and when the brakes are applied, it becomes retarded. Strictly speaking, all motions are varied; there is no illustration of absolutely uniform motion in Nature nor in art, though we may conceive of its possibility and have very closely approximated to it.

Accelerated motion or velocity—Even if several men push against a heavy car we may be unable to recognize any motion for two or three seconds; but, if they continue to exert force upon the car, it will move with greater and greater velocity until the resisting force (which increases with the

PHYSICAL PROPERTIES OF FLUIDS

velocity) becomes equal to that applied by the men. This continually increasing velocity is termed accelerated velocity.

Velocity Head—All particles of matter are attracted to the earth by gravity. When a body of any weight or density falls to the earth it will fall approximately 16 feet in one second, 64 feet in two seconds, 144 feet in three seconds, 256 feet in four seconds, and 400 feet in five seconds, etc., when not acted upon by friction of air. These facts are the results of numerous experiments.

It is noted that the average speed per second increases as the time of falling increases, being 16 feet per second for one second, 32 feet per second for the first two seconds. Since the velocity at the start was zero the velocity at the end of the first second must be 32 feet per second and at the end of two seconds 64 feet per second in order that the average speed would equal 16 feet and 32 feet per second respectively for the elapsed periods.

Acceleration is the increase per second in velocity per second. The velocity increases from rest 0 feet to 32 feet per second in the first second and from 32 feet to 64 feet per second during the second second. Therefore, the acceleration due to gravity is 32 feet per second, and is equal to the velocity at the end of any time period, divided by the time. See Table 5.

Table 5

Time Seconds	<i>H</i> Feet	Average Velocity in ft. per sec.	Velocity <i>V</i> at end of time period in ft. per sec.	Acceleration* <i>g</i> in feet per sec.
0	0	0
1	16	16	32	32
2	64	32	64	32
3	144	48	96	32
4	256	64	128	32
5	400	80	160	32

* The average value of *g* used in calculations in this book is 32.16 except where otherwise designated.

Let V represent the velocity at the end of each time period t , and H equal distance through which the body fell. Then the average velocity = $\frac{V}{2}$

The average velocity also equals $\frac{H}{t}$

Therefore $\frac{H}{t} = \frac{V}{2}$

(a) $H = \frac{V}{2} \times t$

Which fact is that distance equals the average velocity multiplied by the time. But the velocity at the end of each period divided by the acceleration g is equal to the time.

$$\frac{V}{g} = t$$

Substituting this value of t in the above formula (a)

$$H = \frac{V}{2} \times \frac{V}{g}$$

$$H = \frac{V^2}{2g} \text{ or } V = \sqrt{2gH}$$

A body projected upward with a certain velocity will rise to a height equal to the distance through which it would have to fall to acquire this velocity. Therefore $\frac{V^2}{2g}$ is known as the velocity head, and is equal to H .

Inasmuch as any object acquires a velocity V equal to $\sqrt{2gH}$ in falling a distance H , if a certain amount of water fell from point **A** to point **B** a height of m feet as represented in Fig. 22 its velocity V at **B** would be equal to $\sqrt{2gm}$ where $m = H$; also if a stream of water is projected vertically by velocity at point **B** the height to which it would rise would be equal to $\frac{V^2}{2g}$ or m where m is expressed in feet. This

statement will apply to any fluid providing the resistance due to the air, etc., is eliminated. Likewise, if the vessel shown in this figure contained a liquid, the theoretical velocity of the liquid through the orifices at **B** and **C** would also equal $\sqrt{2gm}$ theoretically and the liquid at orifice **C** would rise to the level of the surface of the liquid at **A**. Although the liquid at the surface **A** does not pass through the orifice, a portion of the lower layer of liquid passes through the orifice and consequently the height of liquid is lowered; the portions passing through the orifice being replaced by other portions from a higher level and this same operation continuing until we reach the surface of the liquid so that the effect in reality, is the same as if the liquid from the surface fell through the distance m .

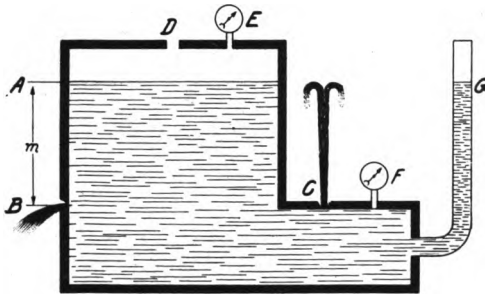

Fig. 22

The total pressure on the liquid on the inside of the vessel at points **B** and **C**, which are on the same level, equals the pressure of atmosphere acting on surface of liquid at **A** plus the pressure due to the height of liquid m above the orifice. The pressure acting on the outside of the vessel or opposing the flow of the liquid through the orifice is the atmospheric pressure, so that the velocity of efflux through the orifice is equal to the difference in the pressure on the inside

of the vessel at points **B** and **C**, and the pressure on the outside of the vessel at the same points, which difference is equal to the head of liquid m .

If the orifice **B** opened into a vessel which was under a perfect vacuum, where the total pressure was zero pounds to the square inch, the difference of pressure between the inside and outside of the vessel would be equal to the atmospheric pressure plus the head m , the outside pressure being zero. Therefore, since the atmospheric pressure is equivalent to a head of 34 feet in case of water at sea level, the total pressure or head on the orifice **C** producing the velocity through the orifice would be 34 plus m or the theoretical velocity of exit would be equal to $\sqrt{2g(34+m)}$ for water. $H = 34 + m$.

Again we will assume that the orifice **B** opened into a vessel in which the same liquid was contained and the height of the liquid in this vessel was two feet above the elevation of the orifice. In this case the difference in pressure between the inside of the vessel at the orifice and the outside of the vessel at the orifice would be $m-2$ feet, in which case the velocity through the orifice would be equal to the $\sqrt{2g(m-2)}$.

As another example we will assume that the opening **D** is attached to an air line from a compressor and that a pressure of 50 pounds per square inch is exerted upon the surface of the liquid as shown by the gauge **E**, and that the liquid flows into the atmosphere through the orifices **B** and **C**. In this case the total pressure on the surface of the liquid would be equal to 50 pounds plus the atmosphere. As one pound per square inch equals 2.3 feet head in case of water, 50 pounds would be equal to 115 feet head which is the height that the water will rise in the open tube **G** above the surface of water at **A**. The total pressure at **B** would be equal to $m+115$ feet plus 34 feet due to the atmospheric pressure. The pressure on the outside of the vessel is equal to

the atmospheric pressure or 34 feet so that the difference in pressure between the inside and outside or the differential pressure causing the flow through the orifice is equal to 115 plus m feet. This is the pressure which would be registered on the gauge at **F**, or the pressure is equivalent to that which would exist if the vessel were increased in height and the elevation of the liquid above point **A** would be 115 feet.

From the above discussion it is seen that the velocity through an orifice for any liquid is equal to $\sqrt{2gH}$, in which H equals the differential in feet head of liquid existing between the two sides of the orifice. The velocity in the case above mentioned is the theoretical velocity. Due to friction, etc., the velocity is less than the theoretical velocity. Due to contraction of the jet the total volume flowing is less than the theoretical volume which would be obtained by multiplying the area of the orifice by the theoretical velocity. Most books on hydraulics and physics divide the difference between the actual and theoretical by applying two sets of multipliers or coefficients, one for contraction of the jet and the other for the decrease of velocity due to friction, etc. However, in all discussions dealing with the flow of fluids by orifice meter only one coefficient C_v is used and this is termed the "coefficient of velocity." C_v is the ratio of the average velocity of the fluid passing the upstream plane of the orifice to the theoretical velocity as determined by the formula $V = \sqrt{2gH}$. It is sometimes called the efficiency of the orifice. However, since this definition of the "coefficient of velocity," has been accepted by nearly all gas engineers, it is used in this sense throughout this book.

TEMPERATURE

The ordinary Fahrenheit thermometer is made and calibrated by partly filling a glass tube terminating in a bulb with some liquid, usually mercury, and sealing. It is cooled to a temperature of melting ice or freezing water at sea level. The point at which the top of the mercury column rests is marked 32 degrees on the tube. It is then heated or placed in boiling water at sea level and the point at which the mercury rests is indicated as 212 degrees. The bore of the tube being uniform, the space between the freezing point and boiling point is divided into 180 parts, each division representing one degree.

Absolute Temperature—It was noted by early experimenters that a definite quantity of gas occupying a certain volume; for example, 6 cu. ft. at 140 deg. fahr. at any definite pressure, upon being cooled to 90 deg. fahr. only occupied 5.5 cu. ft. and at the same pressure, further cooling to 40 deg. fahr. reduced the volume to 5 cu. ft., and at 60 deg. below zero the volume was 4 cu. ft. Therefore for each 100 degrees drop in temperature below the 140 deg. fahr. the volume decreased one cubic foot or one-sixth of the original amount so that theoretically at 600 degrees below 140 deg. fahr. or at 460 deg. below zero the volume should be zero. It is not possible to produce such a condition, but numerous experiments have indicated similar

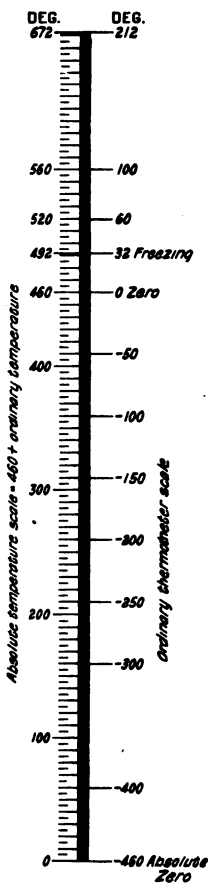

Fig. 23

PHYSICAL PROPERTIES OF FLUIDS

results, and 460 degrees below the zero of the ordinary thermometer scale has been designated as the zero of the fahrenheit absolute scale. The use of the absolute scale enables us to simplify all calculations with respect to gas volumes to a minimum. The absolute temperature scale is expressed in degrees above the absolute zero being equal to 460 plus the ordinary commercial scale.

The previous data is compiled in the following Table:

Table 6

Temperature Ordinary Scale	Degrees Fahrenheit Absolute Scale	Volume Cubic Feet
140	600	6.0
90	550	5.5
40	500	5.0
60 below zero	400	4.0
460 below zero	0	0.0

This table indicates that the same weight of gas at the same pressure occupies volumes directly proportional to the absolute temperature.

Various experimenters have determined the absolute zero at various values from 459.2 to 459.6 deg. fahr. below zero, but as 460 has been used in nearly all gas calculations, this value is retained in this book. Therefore, the absolute temperature is obtained by adding 460 degrees to the ordinary Fahrenheit scale. 80 deg. fahr. = $80 + 460$, or 540 deg. fahr. absolute, 190 deg. below zero is equal to $-190 + 460$, or 270 deg. fahr. absolute.

Temperature Base—In the gas business a temperature base is usually specified. The usual value is 60 deg. fahr. signifying that the standard basis of measurement shall be at that temperature or that all gas volumes shall be changed by calculation and expressed in cubic feet at 60 deg. fahr.

To use this value in calculations it must be expressed in the absolute scale. All tables state the base t_b on which the calculations are made according to the ordinary thermometer. To obtain the absolute value T_b , add 460 degrees. 60 deg. fahr. is 520 deg. fahr. absolute.

PERFECT GASES

In the illustrations which follow, showing by diagram the action of the various laws of perfect gases, we assume a cylinder which is a non-conductor, fitted with a frictionless piston fitting so closely that it does not permit the escape or entrance of any gases. In each instance the contained gas is one-half of a pound of air. It will be noticed that in each example the gauge pressure acts downward on the piston or tending to compress the gas and that in the case of a vacuum the force is assumed to act upward, that is to say there is a pull on the piston instead of a pressure being applied. The pressure of the atmosphere is acting with the gauge pressure to produce the gross or absolute pressure. In the cases of vacuum the force applied is working against the atmosphere or the pulling force plus the pressure of the contained gas just equals the pressure exerted by the atmosphere.

Charles' Law—The volume of a given mass or volume in cubic feet per pound, of any gas under any constant pressure increases proportionately as the absolute temperature increases, and decreases proportionately as the absolute temperature decreases. See Page 52.

Referring to Figs. 24, 25 and 26, it will be seen that if the gas is cooled from 1080 deg. fahr. absolute to 540 deg. fahr. absolute, the volume, without in any way altering the pressure, will be decreased one-half. Therefore, the volume divided by the absolute temperature is a constant for any gas, at the same pressure.

PHYSICAL PROPERTIES OF FLUIDS

$$\frac{v}{T} = c$$

where v = volume per pound in cubic feet.

T = Temperature in deg. fahr. absolute.

c = a constant depending upon the pressure.

Therefore, at one degree absolute the volume would be c cubic feet.

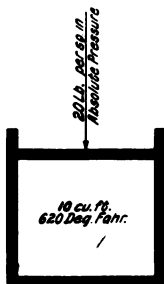

Absolute Temperature
1080 Deg. Fahr.
Wt. per cu. ft. .05 Lb.
Volume per Lb. 20 cu. ft.

Fig. 24

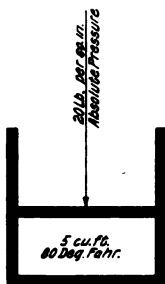

Absolute Temperature
540 Deg. Fahr.
Wt. per cu. ft. .10 Lb.
Volume per Lb. 10 cu. ft.

Fig. 25



Absolute Temperature
270 Deg. Fahr.
Wt. per cu. ft. .20 Lb.
Volume per Lb. 5 cu. ft.

Fig. 26

The formula $\frac{v}{T} = c$ is applied to the above figures as follows:

Fig.	v	T	}	Value of c for air at 20 lb. per sq. in. absolute.
24	$20 \div 1080 = .0185$			
25	$10 \div 540 = .0185$			
26	$5 \div 270 = .0185$			

Table 7

Table showing decrease of volume and increase of weight per cubic foot of air, at same pressure as temperature decreases.

Temperature deg. fahr.		Volume of one lb. in cu. ft.	Weight, lb. per cu. ft.
Absolute	Ordinary		
1080	620	20	0.05
540	80	10	0.10
270	-190	5	0.20

The fact that the volume divided by the absolute temperature is a constant for any certain gas at a certain pressure leads to the following statement,

$$\frac{v_n}{T_n} = \frac{v}{T} = c$$

in which v_n and T_n are the conditions at any volume and temperature at the same pressure, then

$$v_n = \frac{vT_n}{T}$$

Let us assume that the volume of a certain weight of gas is 400 cu. ft. at 40 deg. fahr. at a certain pressure. The volume v_n at 60 deg. fahr. would be

$$v_n = \frac{vT_n}{T} = 400 \times \frac{520}{500} = 416 \text{ cu. ft.}$$

Boyle's or Mariotte's Law—The volume of a given body of gas depends upon the pressure to which it is subjected.

At twice the absolute pressure there is half the volume, while the density and elastic force are doubled. At half the absolute pressure the volume is doubled, and the density and elastic force are reduced to one-half. Hence the law: the volume of a body of gas varies inversely as the pressure, density, or elastic force. This is sometimes called Mariotte's and sometimes Boyle's law, from the names of two men who discovered it at about the same time.

This law is true for all gases within certain limits, but under extreme pressure the reduction in volume is greater than indicated by it. The greatest deviation from it occurs with those gases that are most easily liquefied.

The product of the absolute pressure multiplied by the volume of a given weight of gas is a constant.

$$Pv = k$$

where P = absolute pressure in pounds per cubic foot.

v = volume per pound, in cubic feet.

k = a constant depending upon the temperature.

PHYSICAL PROPERTIES OF FLUIDS

Therefore, at one pound per sq. in. absolute $v = k$ cubic feet. See Table 8 and Figs. 27, 28 and 29.

Table 8

Showing increase of volume per pound and decrease of weight per cubic foot of air as pressure decreases at same temperature (80 deg. fahr.) 540 deg. absolute.

Pressure		Volume in cubic feet of one lb. of air.	Weight in lb. per cubic foot.
Absolute, lb. per sq. in.	Gauge		
40	25.6 lb. per sq. in.	5	.20
20	5.6 lb. per sq. in.	10	.10
10	9 in. mer. vac.	20	.05

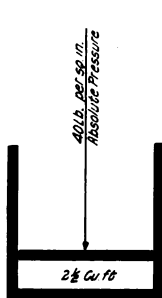

80 Deg. Fahr.
Wt. per cu. ft. 20 lb.
Volume per lb. 5 cu. ft.

Fig. 27

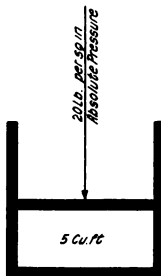

80 Deg. Fahr.
Wt. per cu. ft. 10 lb.
Volume per lb. 10 cu. ft.

Fig. 28

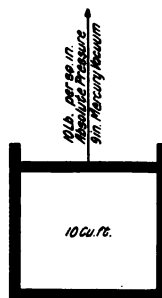

80 Deg. Fahr.
Wt. per cu. ft. 05 lb.
Volume per lb. 20 cu. ft.

Fig. 29

The formula $Pv = k$ is applied to the above figures as follows:

Fig.	P	\times	v	}	Value of k for air at 540 deg. fahr. absolute.
27	40	\times	5 = 200		
28	20	\times	10 = 200		
29	10	\times	20 = 200		

PHYSICAL PROPERTIES OF FLUIDS

The fact that the absolute pressure multiplied by the volume of a given weight of gas is a constant, can be expressed as follows:

$P_n v_n = P v = k$ where P_n and v_n are the new pressures and volumes respectively then $v_n = \frac{P v}{P_n}$

If the absolute pressure of a certain definite weight of gas is 30 lb. per square inch absolute and its volume is 120 cu. ft. at 60 deg. fahr. the volume at 20 lb. per square inch absolute at 60 deg. is

$$v_n = \frac{P v}{P_n} = 30 \times \frac{120}{20} = 180 \text{ cu. ft.}$$

Relation between Absolute Temperature and Absolute Pressure—As the absolute temperature decreases for a definite volume of gas, the absolute pressure decreases at the same rate and vice versa. That is, the absolute pressure divided by the absolute temperature is a constant or the absolute temperature divided by the absolute pressure is a constant. This is illustrated by the table and diagram following.

Table 9

Table showing decrease of pressure as temperature decreases, volume remaining constant.

Absolute temp. deg. fahr.	Temperature deg. fahr.	Absolute Pres- sure lb. per sq. in.	Gauge Pressure
1080	620	40	25.6 lb. per sq. in.
540	80	20	5.6 lb. per sq. in.
270	-190	10	9 inch vacuum.

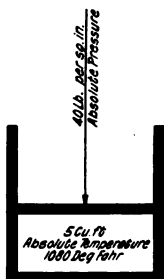

Wt. per cu. ft. 10 lb.
Volume per lb. 10 cu. ft.

Fig. 30

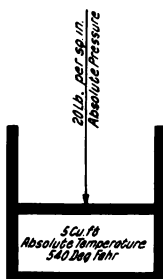

Wt. per cu. ft. 10 lb.
Volume per lb. 10 cu. ft.

Fig. 31

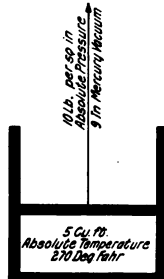

Wt. per cu. ft. 10 lb.
Volume per lb. 10 cu. ft.

Fig. 32

The above relation may be shown as follows:

Fig.	P	T	
30	40	\div	1080 = .037
31	20	\div	540 = .037
32	10	\div	270 = .037

} constant for air at a volume of 10 cu. ft. per lb.

Since the pressure divided by the temperature for a certain definite volume of gas is a constant, the relation may be expressed:

$$\frac{P_n}{T_n} = \frac{P}{T} = \text{a constant}$$

In which P_n and T_n are the new pressures and temperatures respectively.

$$P_n = \frac{PT_n}{T}$$

If a certain volume of gas at a temperature of 40 deg. fahr. (500 deg. absolute) under a pressure of 30 lb. per square inch absolute, is heated, the pressure of the same volume of gas at a temperature of 140 deg. fahr. (600 deg. absolute) would be as follows:

$$P_n = \frac{PT_n}{T} = 30 \times \frac{600}{500} = 36 \text{ lb. per square inch absolute.}$$

Law of Perfect Gases—Let us assume the theoretical volume of a pound of a certain ideal gas at one deg. fahr. absolute under a pressure of one pound per square inch absolute is Z cubic feet; then, according to Charles' Law, the volume increases as the absolute temperature increases, the volume at an absolute temperature, T degrees, will be TZ cu. ft. at one lb. per square inch absolute pressure. But according to Boyle's Law the volume decreases proportionately as the absolute pressure increases, so that if the pressure is increased to a pressure P at an absolute temperature T , the volume per pound $v = \frac{TZ}{P}$

$$\frac{TZ}{P} = v$$

By transposing $\frac{Pv}{T} = Z$

$$\frac{P_n v_n}{T_n} = \frac{Pv}{T} = Z$$

where P_n , v_n and T_n represent the pressure, volume and temperature of the same gas at other conditions than those represented by P , v and T .

therefore, $v_n = \frac{PvT_n}{P_n T}$

If the volume of a certain weight of gas is 20 cu. ft. at 10 lb. per square inch absolute at a temperature of 40 deg. fahr., (absolute temperature 500 degrees), the volume at 60 deg. fahr. (520 deg. absolute) under a pressure of 26 lb. per sq. inch absolute would be

$$v_n = \frac{PvT_n}{P_n T} = \frac{10 \times 20 \times 520}{26 \times 500} = 8 \text{ cu. ft.}$$

Therefore, for a unit weight of gas the product of the volume

PHYSICAL PROPERTIES OF FLUIDS

v multiplied by the absolute pressure P divided by the absolute temperature T is a constant Z . The value of Z for air is 0.37 approximately.

$$\frac{Pv}{T} = Z$$

for air using one pound the expression becomes $\frac{Pv_a}{T} = .37$

where P = absolute pressure in pounds per square inch.

v_a = volume in cubic feet of one pound of air.

T = absolute temperature in deg. fahr.

The specific gravity of a fluid is the ratio of the weight of a cubic foot under the same pressure and temperature conditions to the weight of a cubic foot of another fluid used as a standard or base. For gaseous fluids air is generally used as a base and consequently its specific gravity is considered 1.00. For liquids water is used as a base and its specific gravity is considered 1.00 at point of maximum density.

Returning to the above formula in which v_a represents volume of cubic feet occupied by a pound of air, it can be readily understood that if the specific gravity of a gas is less than air, the volume of a pound is greater proportionately than of a pound of air. If v represents the volume of a pound of the gas

$$v = \frac{v_a}{G} \text{ or } v_a = vG$$

Substituting in the above expression vG for v_a ,

$$\text{we obtain } \frac{PvG}{T} = .37$$

The product of the absolute pressure in pounds, volume per pound and specific gravity of any gas divided by its absolute temperature, is equal to .37.

$$v = \frac{.37 T}{PG}$$

The volume of a pound of gas, at 60 deg. fahr., specific gravity, .60 under a pressure of 14.4 absolute is

$$v = \frac{.37T}{PG} = \frac{.37 \times 520}{14.4 \times .60} = 22.2 \text{ cubic feet.}$$

Applying the formula $\frac{PvG}{T}$ in examples given in which air was the gas under consideration, (specific gravity 1.00) the following results are obtained.

Constant Pressure. Figs. 24, 25 and 26

$$\frac{PvG}{T} = \frac{20 \times 20 \times 1}{1080} = \frac{20 \times 10 \times 1}{540} = \frac{20 \times 5 \times 1}{270} = .37$$

Constant Temperature. Figs. 27, 28 and 29

$$\frac{PvG}{T} = \frac{40 \times 5 \times 1}{540} = \frac{20 \times 10 \times 1}{540} = \frac{10 \times 20 \times 1}{540} = .37$$

Constant Volume per pound or Constant Weight per
cubic foot. Figs. 30, 31 and 32

$$\frac{PvG}{T} = \frac{40 \times 10 \times 1}{1080} = \frac{20 \times 10 \times 1}{540} = \frac{10 \times 10 \times 1}{270} = .37$$

It is noticed that if the value of any term in this characteristic equation is changed the value of one or more of the others must change. A clear understanding of this equation and its derivatives will eliminate most of the troubles now experienced in the application of the various factors used in measurement of gases. The only term in this equation which cannot be readily determined in the field is v . Its value can easily be calculated, and even so, its value is not generally required.

PRESSURE DUE TO HEAD OF GAS

Due to the universal expansibility of gas, in order to keep the gas from diffusing it is necessary to confine it in an inclosed vessel. Let the vessel **ABCD** be filled with air at atmospheric pressure. Due to the light weight per cubic foot it is generally assumed that the weight of a cubic foot at the top of the vessel would be the same as the weight of a cubic foot at the bottom of the vessel. This statement is not strictly true for the reason that the air itself weighs something, and the weight of the upper layers tend to compress each lower layer. Assuming that the air is uniform in density, and that the pressure acting on the air by the walls of the container is equal to the atmospheric pressure, the pressure acting on the surface **CD** would be equal to the pressure on the surface **AB** which is the pressure acting on the gas at **AB** plus the weight of the air contained in the vessel, so that on each square inch of surface **CD**, the pressure is equal to the pressure per square inch acting at **AB** plus the weight of a column of the air one inch square **AC** in height.

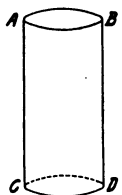

Fig. 33

Air at atmospheric pressure weighs approximately $\frac{1}{13}$ of a pound at 60 deg. fahr. so that if **AC** is 1872 feet the pressure acting on each square foot on the surface **CD** is 144 pounds greater than the pressure per square foot on **AB** or one pound per square inch greater than on **AB** so that 1872 feet head of air is equal to one pound per square inch or 144 pounds per square foot. Therefore, the head of gas may also be ex-

pressed in pounds per square inch or the pressure in pounds per square inch may be expressed in feet head of gas (at a certain pressure and temperature of the gas).

Pressures and Gas Heads

From the preceding articles it is evident that the pressure head of any fluid may be expressed in terms of head of any other fluid or it may be expressed in terms of weight per square inch. The units of weight used throughout this volume are (unless otherwise stated)

1 cubic foot of water at 62 deg. fahr. weighs 62.355 lb. per sq. inch.

1 cubic foot of air at 60 deg. fahr. at 14.7 lb. pressure weighs .076381 lb. per cubic foot.

Therefore, a column of water one square foot in area, one foot high, is equal to $\frac{62.355}{.076381}$ or 816.37 feet of air at 60 deg.

fahr. at 14.7 lb. per square inch, one square foot in area. Inasmuch as air or any gas increases in volume as the absolute pressure decreases, one foot of water will equal 816.37×14.7 or 12000 feet of air at 60 deg. fahr. at one pound absolute pressure. Therefore, one inch of water is equal to 1000 feet of air at 60 deg. fahr. at one pound per square inch absolute pressure. From the laws of perfect gases, for any other pressure one inch of water is equal to $\frac{1000}{P}$ in which P is the ab-

solute pressure in pounds per square inch. For any other temperature than 60 deg. fahr., since the volume of air increases as the absolute temperature increases, the head in

feet of air would equal $\frac{1000}{P} \times \frac{T}{520}$ in which T would be the absolute temperature in deg. fahr. and 520 the absolute temperature corresponding to 60 deg. fahr.

PHYSICAL PROPERTIES OF FLUIDS

One inch of water = $\frac{1000T}{520P}$ feet head of air, and since the volume per pound decreases as the specific gravity G increases, one inch of water = $\frac{1000T}{520PG}$ feet of any gas.

When H = differential in feet head of gas and h = differential in inches of water,

$$H = \frac{1000 hT}{520 PG}$$

Example, Gas.

Differential, 3 inches of water.

Specific Gravity, .80. Atmospheric Pressure, 14.4 lb.

Gauge Pressure, 48.1 lb. Temp., 60 deg. fahr.

Solution: $P = 48.1 + 14.4 = 62.5$ lb. per sq. in. abs.

$T = 60 + 460 = 520$ deg. fahr. abs.

3 inches of water = $\frac{1000 hT}{520 PG} = \frac{1000 \times 3 \times 520}{520 \times 62.5 \times .80} = 60$ ft. head of gas at the temperature and pressure stated.

VELOCITY HEAD OF FLOWING GASES

Just as the velocity of efflux through an orifice is proportional to the differential pressure between the liquid pressures on the two sides of the orifice, expressed in feet head of flowing liquid, the velocity of the flow of gases obeys the same laws in that

$$V = C_v \sqrt{2gH}$$

in which case H is the differential in feet head of flowing gas at the pressure and temperature existing either at the inlet side or the outlet side of the orifice. In orifice meter measurements the percentage differences between these pressures are very small. With some types of connections the upstream pressure is used and with the other types the downstream pressure is used.

PHYSICAL PROPERTIES OF FLUIDS

As an example of the theoretical flow of gas at 60 deg. fahr. assume a container of air, the pressure on the upstream side of the orifice as 50 lb. per square inch absolute and the pressure on the downstream side as 49.82 lb. per square inch. Then the difference in pressure is .18 lb. or 5 inches of water ($.18 \times 27.71 = 5$). One inch of water equals $\frac{1000}{50}$ or 20 feet of air at 50 lb. absolute pressure, at 60 deg. fahr.

Therefore $H = 20 \times 5$ inches of water or 100 feet head of air,

and $V = \sqrt{2g \times 100}$ or $V = 80$ feet per second as the theoretical velocity of the air, each cubic foot passing the orifice at 50 lb. absolute pressure, at 60 deg. fahr.

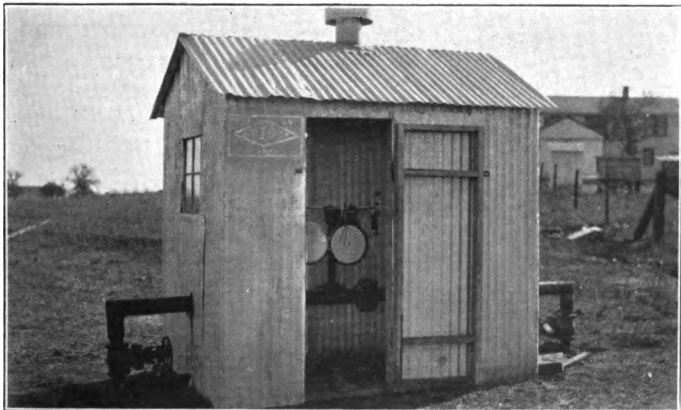

Fig. 34

PHYSICAL PROPERTIES OF FLUIDS

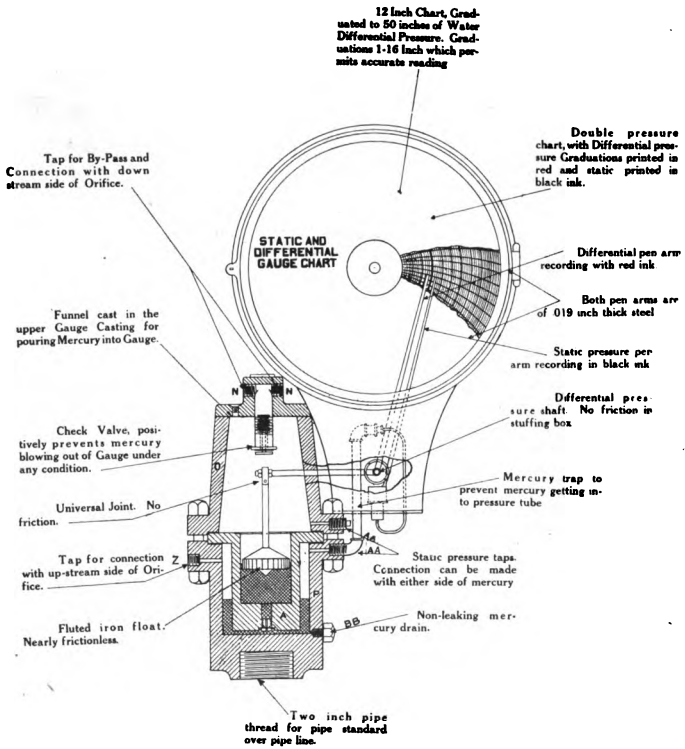

Fig. 35—SECTIONAL VIEW OF A 50 INCH DIFFERENTIAL GAUGE CONCENTRIC CHAMBERS

PART THREE

ORIFICE METER MEASUREMENT

GENERAL—ORIFICES—DETERMINATION OF ORIFICE COEFFICIENTS—MEASURING FLOW OF FLUIDS—DIFFERENTIAL GAUGES—ACCURACY OF ORIFICE METER—DIFFERENTIAL GAUGE CAPACITIES—DIFFERENTIAL RANGE—PRESSURE CONNECTIONS OR TAPS—PRESSURE LOSS—PULSATING FLOW—INSTRUCTIONS FOR METER ATTENDANTS AND TESTING APPARATUS.

GENERAL

In determining the flow of fluids (gases, vapors, or liquids), through pipe lines two general types of meters are used, the direct or displacement type and the indirect or velocity type. Displacement meters are installed for measuring ordinary rates of flow under low or high pressure, especially of gases and vapors. The velocity type is generally used for measurement in large capacity lines under high pressure.

The most familiar forms of displacement meters are the domestic gas meter, the water meter and the station meter. The proportional meter also belongs to this class although it measures only a definite percentage of the flow by displacement. The operation of the direct type consists of automatically filling and emptying a space of definite volume, counting the number of times the space is filled and emptied by means of gearing, indicating the result in cubic feet, gallons, pounds, etc.

The velocity type includes the Pitot Tube with all of its variations, and the Orifice Meter, in which the flow is determined by the simple fact that the volume flowing is equal

ORIFICE METER MEASUREMENT

to the area of a section multiplied by the rate of flow or velocity through this section. For example, if the rate of flow of a gas or liquid through a pipe line whose area is one square foot is 3000 feet per hour the volume passing any point through the line per hour is equal to the area of the cross section of the pipe (1 sq. ft.) multiplied by 3000 feet or 3000 cu. ft. per hour.

Of the velocity type the Orifice Meter has become the most widely known on account of its adaptability, simplicity and accuracy. An orifice meter will measure the flow of any gas, vapor or liquid of fairly uniform gravity at high pressure or under a vacuum. In fact, they are used successfully for many kinds of gases and liquids such as Natural Gas, Casing-head Gas, Manufactured Gas, Coke Oven Gas, Pintch Gas, Compressed Air, Steam, Water and Oil.

The orifice disc or meter is simply a machined circular plate one-fourth inch in thickness having an orifice or circular opening in the center of the plate. For cross section see Fig. 36.

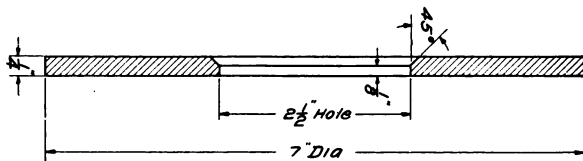

Fig. 36—SECTIONAL VIEW OF ORIFICE DISC

The meter is installed by placing the orifice disc between two flanges or in a body casting in a pipe line with the center of the orifice in the center of the pipe, and connecting the Static and Differential Pressure Gauge with quarter inch pipe to two taps in the pipe or flanges, one on each side of the orifice disc.

The accuracy of the meter depends only upon the machining of the orifice disc which can be done easily with extreme precision. Any small pebbles or accumulation of

dirt or rust in the pipe do not produce an appreciable effect on the results; whereas, in the other meters of the velocity type any obstruction equivalent to only a very small percentage of the area of the pipe affects the accuracy to a large extent.

For each installation the orifice in the orifice disc, when placed in the pipe line, forms a definite section of unchanging area, and creates a definite difference between the static pressure of the fluid on the upstream side of the orifice, and the static pressure of the fluid on the downstream side of the orifice, for each velocity or rate of flow of the fluid,* at the same density. This difference in static pressures is termed the differential pressure or the "differential." In other words the "differential," and static pressure, in cases of gases and vapors, indicate the velocity.

The Differential and Static Pressure Gauge records on a chart the differential pressure existing between the pressure connections, and the static pressure at one of the connections. These factors with the known area of the orifice enable the operator to determine the flow by multiplying the Pressure Extension by the Hourly Orifice Coefficient.

The layout of an orifice meter installation may be indicated as in Fig 38 where **M** and **F** represent static pressure gauges attached to the upstream connection at **U** and downstream at **D** respectively. The pressure connections are also attached to a U tube, upstream at **H**, and downstream at **L**. When there is no flow through the line the two gauges will register the same, but when a flow exists it will be observed that the gauge at **M** will register more than the gauge at **F**; also that the pressure at **H** being greater than at **L** will cause the liquid in column **H** to lower and in column **L** to raise. The difference in the level of surfaces of the liquid in the columns being the "differential" h . If the area of orifice is equal

* Throughout this volume the term fluids is used to include gases, vapors and liquids and the term gas applies to any gas and air.

ORIFICE METER MEASUREMENT

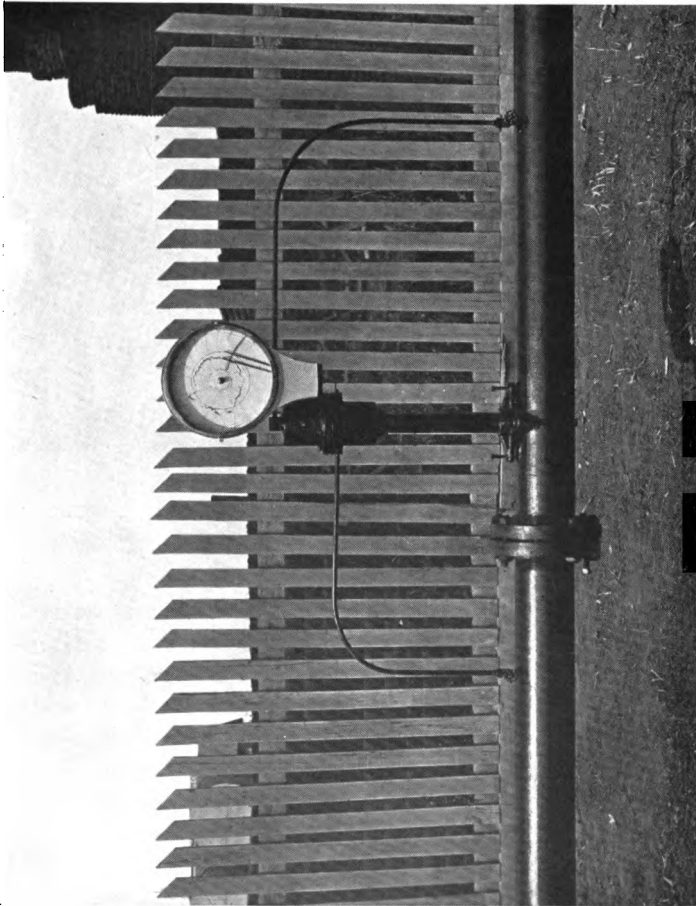

Fig. 37—60 INCH DIFFERENTIAL GAUGE INSTALLATION. See Fig. 75.

ORIFICE METER MEASUREMENT

to the area of the pipe, the velocity through it would be the same as in the other adjacent portions of the pipe.

If discs having consecutively decreasing areas of orifices are placed in the same line, the velocity of the fluid through the orifices would be increased while the static pressure at the upstream connection would be increased and the static pressure at the downstream connection would be decreased.

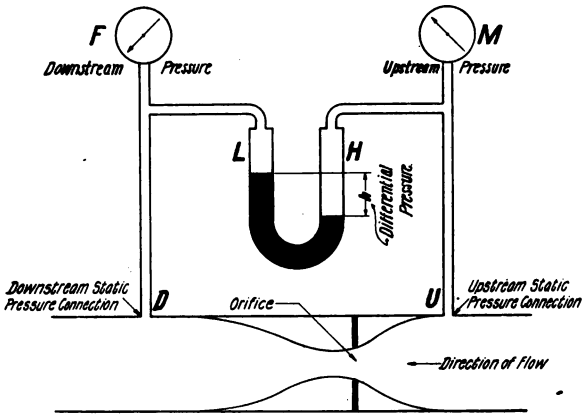

Fig. 38—DIAGRAM OF ORIFICE METER INSTALLATION

The differential pressure between the connections is the pressure creating the flow between the connections. If a series of taps were made in a line of uniform size in which a fluid is flowing, the pressures taken at each of these taps would decrease until at the outlet it would be zero; similarly, if two vertical pipes were attached to a line through which water is flowing, one on each side of an orifice, it would be observed that the water on the upstream side of the orifice disc would rise to a higher level than that on the downstream side of the orifice disc. This difference in levels is also the pressure differential, being the same in amount as would be measured by a differential gauge, which is a modified form of U tube using mercury as a liquid. The

ORIFICE METER MEASUREMENT

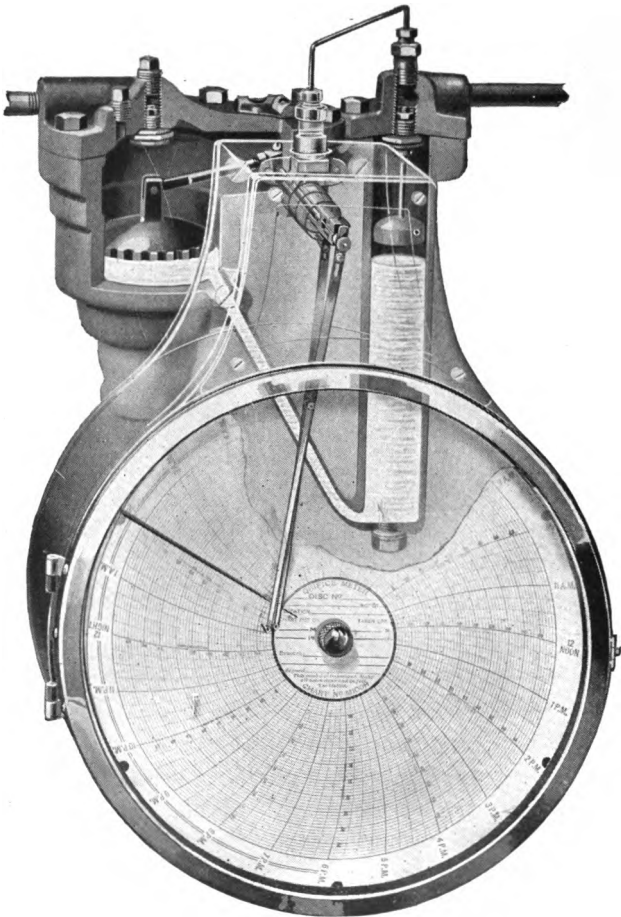

Fig. 39

difference in levels between the surfaces of the mercury in the columns of the gauge is indicated on a chart by a pen arm actuated by a cast iron float moved by the rise and fall of the mercury in one of the columns. See Fig. 39.

In an actual installation the differential h and static pressure, either at **M** or **F**, are usually recorded on the same gauge. Where the pressure connections are made at points $2\frac{1}{2}$ diameters upstream and 8 diameters downstream the static pressure at **M** is recorded, and where the connections are made at the flanges the static pressure at **F** is recorded, as the published values of coefficients for these two types of connections were determined by using the values of the static pressures obtained in this manner.

ORIFICES

Gas is being measured by many types of orifices developed by many experimenters.

The types generally used are; the thin plates with the cylindrical hole which vary from $\frac{1}{32}$ inch to $\frac{1}{8}$ inch in thickness; plates of varying thickness from $1\frac{1}{4}$ inch to $\frac{1}{4}$ inch, drawn down by bevelling at various angles to a thin edge at the circular opening in the center of the plate.

Orifice plates are made of such materials as soft iron, coated with German silver to prevent corrosion; mild steel boiler plates; case-hardened or tempered steel.

The use of these materials is due to various theories as to the action of gas on the disc. The non-corrosive plating or coating is used on the theory that the principal danger is from change in area of the orifice by corrosion. The use of hardened steel is based on the theory that the principal danger is a change in area from a scouring or sand-blasting of the hole. The mild steel plates are used on the assumption that neither of the two effects mentioned above is a source of serious trouble, but that the important thing is to be able

ORIFICE METER MEASUREMENT

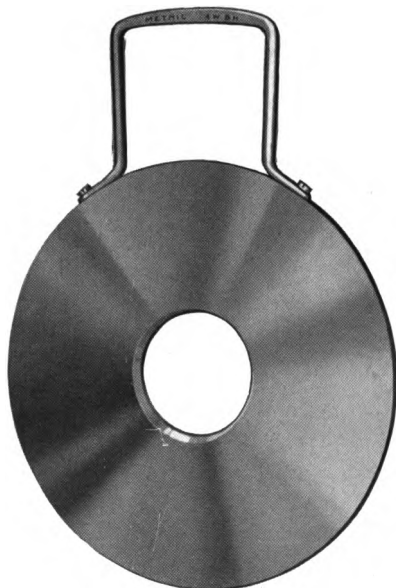

Fig. 40—THIN ORIFICE USED IN ORIFICE FLANGE

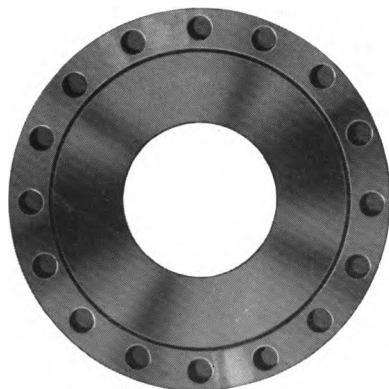

Fig. 41—ONE TYPE OF THIN PLATE ORIFICE USED IN ORIFICE BODY, Fig. 42

ORIFICE METER MEASUREMENT

Table 10—ORIFICE CONSTANTS

Diameter of Orifice Inches	Square of Diameter Inches ²	Area Orifice Sq. Ft.	Volume in Cu. Ft. per hour for a velocity of one foot per second
$\frac{1}{4}$.062500	.000 340 886	1.22719
$\frac{3}{8}$.140625	.000 766 993	2.76117
$\frac{1}{2}$.250000	.001 363 54	4.90875
$\frac{5}{8}$.390625	.002 130 54	7.66992
$\frac{3}{4}$.562500	.003 067 97	11.0447
$\frac{7}{8}$.765625	.004 175 85	15.0330
1	1.000000	.005 454 17	19.6350
$1\frac{1}{8}$	1.265625	.006 902 93	24.8505
$1\frac{1}{4}$	1.562500	.008 522 14	30.6797
$1\frac{3}{8}$	1.890625	.010 311 8	37.1224
$1\frac{1}{2}$	2.250000	.012 271 9	44.1788
$1\frac{5}{8}$	2.640625	.014 402 4	51.8487
$1\frac{3}{4}$	3.062500	.016 703 4	60.1322
$1\frac{7}{8}$	3.515625	.019 174 8	69.0293
2	4.000000	.021 816 7	78.5400
$2\frac{1}{8}$	4.515625	.024 629 0	88.6643
$2\frac{1}{4}$	5.062500	.027 611 7	99.4022
$2\frac{3}{8}$	5.640625	.030 764 9	110.754
$2\frac{1}{2}$	6.250000	.034 088 6	122.719
$2\frac{5}{8}$	6.890625	.037 582 6	135.297
$2\frac{3}{4}$	7.562500	.041 247 2	148.490
$2\frac{7}{8}$	8.265625	.045 082 1	162.296
3	9.0000	.049 087 5	176.715
$3\frac{1}{4}$	10.5625	.057 609 7	207.395
$3\frac{1}{2}$	12.2500	.066 813 6	240.529
$3\frac{3}{4}$	14.0625	.076 699 3	276.117
4	16.0000	.087 266 7	314.160
$4\frac{1}{4}$	18.0625	.098 515 9	354.657
$4\frac{1}{2}$	20.2500	.110 447	397.609
$4\frac{3}{4}$	22.5625	.123 060	443.015
5	25.0000	.136 354	490.875
$5\frac{1}{4}$	27.5625	.150 331	541.190
$5\frac{1}{2}$	30.2500	.164 989	593.959
$5\frac{3}{4}$	33.0625	.180 328	649.182
6	36.0000	.196 350	706.860
$6\frac{1}{4}$	39.0625	.213 054	766.992
$6\frac{1}{2}$	42.2500	.230 439	829.579
$6\frac{3}{4}$	45.5625	.248 506	894.620
7	49.0000	.267 254	962.115
$7\frac{1}{4}$	52.5625	.286 685	1032.06
$7\frac{1}{2}$	56.2500	.306 797	1104.47
$7\frac{3}{4}$	60.0625	.327 591	1179.33
8	64.0000	.349 067	1256.64
$8\frac{1}{4}$	68.0625	.371 224	1336.41
$8\frac{1}{2}$	72.2500	.394 064	1418.63
$8\frac{3}{4}$	76.5625	.417 585	1503.30
9	81.0000	.441 788	1590.44

ORIFICE METER MEASUREMENT

to machine the orifice to an exact micrometer dimension so that the capacity can be determined by measurement of the orifice and a predetermined coefficient can be used without individual calibrations for each disc. The principle is self-evident, that more accurate calibrations can be made for a determination for the purpose of establishing a standard for all meters than is possible in individual calibrations for each

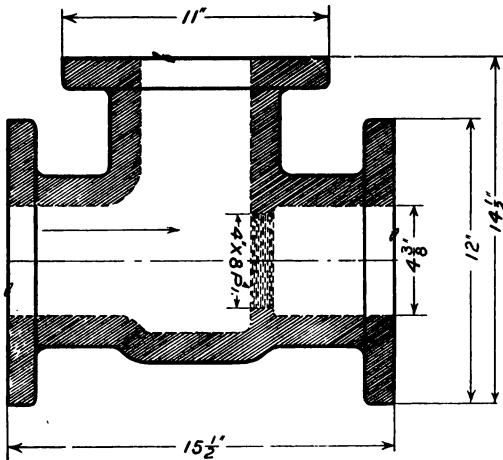

Fig. 42—SECTIONAL VIEW OF AN ORIFICE METER BODY

individual meter. Those advocating case-hardened orifices or orifices requiring individual calibration believe that corrosion and wear are more dangerous to accuracy than possible variations in individual calibrations.

DETERMINATION OF ORIFICE COEFFICIENTS

For Connections $2\frac{1}{2}$ Diameters Upstream and 8 Diameters Downstream

There are several methods of taking differential pressures on the two sides of the orifices, each producing different values of the coefficients.

It is the intention of the author to carefully explain the complete methods used in obtaining the coefficients found on Pages 173 to 184. Due credit should be given not only to the Wichita Pipe Line Co. of Bartlesville, Okla., but to A. J. Discher, formerly General Manager, F. P. Fisher, formerly Assistant General Manager, and to E. O. Hickstein, who carried out the actual tests.

Primarily, it might be said that the work was started by the Wichita Pipe Line Co., whose permission was obtained for the publication of the coefficients in the first edition of this book. Other companies have since checked these coefficients and very little necessity for revision has been found.

While Mr. E. O. Hickstein was the engineer in charge of all tests, he was ably assisted by other engineers in the work. Every facility was given the corps of engineers in the above work. Such equipment as artificial gas holders and high pressure pipe lines of several miles in length were used.

The work was not accomplished in a few weeks or months, but covered a period of several years, and not until the coefficients had been in use for two or three years were they published.

Later tests were made using a 2200 cubic foot holder enclosed within a building. These were known as the Erie tests, and were made at the Plant of the Metric Metal Works. The author was present during these tests which required about one month's time.

ORIFICE METER MEASUREMENT

The work was done in 1913 and cannot be said to be completed at this writing. However, in 1915 sufficient work had been done to warrant placing the coefficients before other gas companies for their use as well as criticism.

JOPLIN HOLDER TESTS*

"The discs tested by the method to be described are machined out of quarter-inch boiler plate or tool steel. The edge of the orifice proper is flat for $\frac{1}{8}$ in. to $\frac{1}{2}$ in. and bevelled at 45 deg. for the remainder of the thickness of the plate.

The ordinary practice in orifice meter installations is to have the gauge line connections right at the flange, that is, the inlet and the outlet pressures are taken within an inch or two of the orifice disc, through holes drilled into the companion flanges. In this particular, the meters of the type tested by the author show a departure from the common practice. In the meters tested, the high pressure connection was two and a half times the diameter of the pipe line ahead of the orifice disc, and the low pressure connection was eight times the diameter of the pipe line behind the disc. This means that in an orifice meter installation on a 10 in. line, for example, the high pressure connection is 25 in. in front of the disc, and the low pressure connection 80 in. behind it, regardless of the size of the orifice in the line.

It was found by experiments made at Charlottenburg some eight years ago (1907), that, for any flow through an orifice disc not giving an excessive drop in pressure, pressure connections at just the distances mentioned above would give a smaller pressure drop across the disc than would connections placed at any nearer position to the disc. There can hardly be any doubt but that the inserting of an orifice disc in a pipe line would cause eddies, and while there is no

*Extracts from "The Flow of Air through Thin Plate Orifices," by E. O. Hickstein, Jun. Am. Soc. M. E.—Presented at the Annual Meeting of the American Society of Mechanical Engineers, Dec. 7-10, 1915.

evidence to show that the presence of eddies would affect the accuracy of any measurement through the disc, it was thought best to eliminate this source of possible uncertainty.

Derivation of Orifice Meter Formulae for Flow of Air*

The fundamental formula for flow through an orifice is

$$V = C_v \sqrt{2 g H} \dots\dots\dots [1]$$

where V = velocity of flow through the orifice, ft. per sec.

C_v = so-called "velocity coefficient," varying with the size and shape of the disc. This constant is also known sometimes as the "efficiency," though this term is misleading.

g = acceleration due to gravity, ft. per sec., per sec.

H = drop in pressure through the orifice disc, expressed in feet of head of the fluid flowing, at temperature and pressure conditions of flow.

In this fundamental formula, the differential drop across the orifice is given in terms of feet head of fluid. The differential pressure gauges used in commercial meter installations are nearly all graduated to read in inches of water drop in pressure. It is necessary, therefore, to derive from the fundamental formula an expression in which the drop is in terms of inches of water. This can readily be done, as follows:

Assuming air as the flowing fluid, the fundamental formula [1] can be written

$$Q_1 = \frac{\pi d^2}{4 \times 144} C_v \sqrt{2 g H} \dots\dots\dots [2]$$

where Q_1 = volume of fluid (air in this case) flowing per 15 min., in cubic feet at pressure and temperature P and T respectively (the conditions at inlet of orifice)

d = diameter of orifice, in.

C_v , g and H as in the fundamental formula [1].

*The subscripts in this article have been changed by the author to conform to the remainder of the book.

To reduce the value Q_1 , which expresses volume at temperature and pressure conditions of flow, to Q , the volume at the standard conditions of temperature and pressure (call T_b and P_b the standard conditions), it is only necessary to apply the perfect gas law. This is done by multiplying the right-hand side of equation [2] by PT_b/P_bT .

The drop in head, H , now expressed in feet of fluid at P and T , must be reduced to inches of water, as explained above. Kent gives 1 ft. of air at 32 deg. fahr. as equal to 0.015534 in. head of water at 62 deg. From this, one foot head of air at P and T is equal to $(0.015534 P 492) \div (14.7 \times T)$ inches head of water at 62 deg. Formula [2] can now be written:

$$Q = \frac{900 \pi d^2 P T_b}{4 \times 144 P_b T} C_v \sqrt{\frac{2 g h \cdot 14.7 T}{0.015534 \times 492 \times P}} \dots\dots [3]$$

and then simplified to

$$Q = 54.65 d^2 \frac{T_b}{P_b} C_v \sqrt{\frac{h P}{T}} \dots\dots [4]$$

Formula [4] is the general formula for calculating the flow of air through an orifice disc. A further simplification of this formula is practicable, however, for commercial purposes. As the temperature of the flowing gas is not usually measured, an average value is assumed. This is taken in Oklahoma as 60 deg. fahr. The pressure and temperature standards are definite, being usually fixed by contract. All these values, together with d , the diameter of the orifice, can be assembled into one constant, which reduces formula [4] to

$$Q = C_a \sqrt{h P} \dots\dots [5]$$

where C_a is the so-called "air constant," found experimentally.

Orifice Meter Formulae for Gas

The orifice meter formulae for flowing gas are derived by the same steps as those for flowing air. In the reduction of H (the differential of the fundamental formula expressed

ORIFICE METER MEASUREMENT

in feet head of the fluid) to h (the differential in inches of water) the density of the gas must be considered. If the specific gravity of the gas be taken as G , where air equals unity, the general formula for the flow of gas through an orifice meter becomes

$$Q = 54.65 d^2 \frac{T_b}{P_b} C_v \sqrt{\frac{h P}{G T}} \dots \dots \dots [6]$$

This formula corresponds with formula [4] for flowing air.

The simplified commercial formula for a gas flow becomes

$$Q = \frac{C_a}{\sqrt{G}} \sqrt{h P} \text{ or } C_g \sqrt{h P} \dots \dots \dots [7]$$

where C_g is the so-called "gas coefficient," the meaning of which will be explained. This formula corresponds with formula [5] for flowing air.

Formula [7] is the formula actually used in commercial measurement. The values of P and h are shown by the recording pressure and differential pressure gauges, and C_g is mathematically derived from the constant of the disc as found by experiment. From the two readings and the gas coefficient, the delivery through the meter can be calculated.

Relationship Between the Constants, C_v , C_a and C_g

As a rule, the theoretical velocity coefficient, C_v , is not used in calculating deliveries through an orifice. Its usefulness lies principally in the mathematical analysis of the formulae and for purposes of comparing experimental data of tests made under widely differing conditions.

C_a , the air constant, and C_g , the gas coefficient, are the quantities that are used commercially. The relation between these two, as can be seen by comparing formulae [5] and [7], is expressed by the equation

$$C_g = \frac{C_a}{\sqrt{G}} \dots \dots \dots [8]$$

C_a , the air constant, is the value that is experimentally found, and does not vary for any disc, unless the assumed standards are changed. The gas coefficient, on the other hand, being a function of the gravity of the flowing gas, will vary, and the gas coefficients of identical discs would be different if the discs were passing gases of different gravities. Orifice disc calibration tests are therefore usually figured for C_a , the air constant, and this is the value that is recorded. Whenever a disc is put in line at a measuring station, the gravity of the gas to be measured is found by a test, and the proper gas coefficient calculated.

The relation between C_v and C_a is found by equating the right-hand sides of formulae [4] and [5], and can be expressed as

$$C_v = 11.55 \frac{C_a}{d^2} \dots\dots\dots [9]$$

General Outline of the Joplin Tests

The tests on orifice meter discs to be described in this paper were carried out at Joplin, Mo. The discs were calibrated against the displacement of air from an old artificial gas holder at that place. The holder was a two-lift holder, water sealed and of 250,000 cu. ft. nominal capacity. Roughly speaking, its dimensions were 90 ft. in diameter by 40 ft. total height. The lower lift only was used in the tests; this lift has a capacity of 110,000 cu. ft. The reason for using only the lower lift was the change in pressure of the air in the holder, as one lift seated on the bottom.

Of the several original outlets from the holder, all but one were securely blanked. The remaining 12 in. outlet was led into a long building, and connected to a straight run of some 40 ft. of pipe, near the center of which was the orifice flange. The air passing out of the holder went through the orifice disc, and discharged into the atmosphere perhaps 20 ft. beyond. A motor driven blower was used to fill the holder with air previous to each test.

ORIFICE METER MEASUREMENT

LEAKAGE TESTS ON HOLDER.—The first tests made were to determine the rate of leakage from the holder. In order to obtain a fair average, a number of such tests were run at the start, with the holder at varying heights. Leakage tests were also run at intervals throughout the whole work, to make sure that the leakage figure first obtained had not materially changed.

The first leakage tests (run during August, 1913) were unsatisfactory on account of the large difference between temperature conditions at the start and finish of test. To avoid this difficulty, tests of 24 hours duration, starting at about midnight, were made, and better results obtained. The average of three long leakage tests showed 103 cu. ft. leakage per hr. The correction used in all the Joplin tests was taken as 100 cu. ft. per hr. The result of later leakage tests showed practically the same leakage as the above average, the highest value in any 24 hr. test being 115 cu. ft. per hr.

CHANGES OF VOLUME IN HOLDER WITH TEMPERATURE VARIATION.—During the leakage tests, it was noticed that the rise and fall of the holder with temperature changes was a greater factor than had been anticipated. A 4 ft. rise from midnight to noon was not uncommon during the hot weather. It was necessary, therefore, to ascertain very accurately the proper correction to apply for temperature changes taking place during a test.

Table 11 shows observations and calculated results made in a test run for this purpose. The holder was filled to about three quarters capacity and allowed to stand, hourly readings being taken of all quantities involved. The so-called "top" temperature is the reading found by lowering a thermometer 2 ft. or so into the holder through a bolt hole on top.

From the data the net change in volume due to temperature variation for each hourly period was calculated. It was found that the changes in volume as observed were

ORIFICE METER MEASUREMENT

Table 11—Readings and Calculated Results of First 24 Hours Test on Gas Holder for Investigating Variation of Volume of Air in Holder with Temperature Change.

Time	Temperatures		Change of Volume of Air in Holder Corrected for Level of Water Seal and for Leakage In. Height		Calculated "Combined" Temp.	Calculated Theoretical Change of Volume from Beginning of Test	Same Values Corrected for Calculated Lag of 8¼ in. at Start
	Atmos.	"Top"	During Previous Hour	From Beginning of Test			
6 p. m.	96	103	98½	— 8¼
7 p. m.	93	97	—8½	— 8½	94½	— 6½	—14¾
8 p. m.	90	91	—8½	—17¾	90½	—11¾	—20½
9 p. m.	88	88	—4½	—21½	88	—15½	—23¾
10 p. m.	87½	86	—2½	—24½	87	—16¾	—24½
11 p. m.	86	86	—1½	—25¼	86	—17¾	—25½
12 night	85	85	—1½	—26½	85	—18¾	—27½
1 a. m.	84	84	—1¼	—27½	84	—20½	—28¾
2 a. m.	82	83	—1½	—29½	82½	—21¾	—30
3 a. m.	81	82	—1½	—30½	81½	—23	—31¼
4 a. m.	80	81	—1¼	—31¾	80½	—24¼	—32½
5 a. m.	79½	80	—1¾	—32½	79¾	—25	—33¼
6 a. m.	78½	80	— ¼	—33½	79	—25¾	—34
7 a. m.	80	86	5½	—27½	82	—27¾	—30½
8 a. m.	85½	100	7½	—20½	90½	—10¾	—19
9 a. m.	87½	108	7¼	—12½	94½	— 5	—13¼
10 a. m.	92	118	7½	— 5½	101	4¾	— 3¾
11 a. m.	95	122	7½	1½	104	9½	7½
12 noon	96	131	5½	6¾	108	16¾	8½
1 p. m.	98	132	2½	9¼	109½	19½	10¾
2 p. m.	100½	131½	1	10¼	111	21¾	13½
3 p. m.	100½	129	2½	12½	110	20	11¾
4 p. m.	98½	126	—2½	9½	107½	15¾	7½
5 p. m.	97	117	—2¾	6¾	104	9½	1¼
6 p. m.	94½	109	—4½	2½	99½	2	— 6¼

Height of top of holder, at start, above water in seal, 421 in.
Date of test, August 8-9, 1913.

ORIFICE METER MEASUREMENT

always greater than a calculation based on the ratio of absolute temperatures alone would give. After some little study and debating, it was decided that this was due to the presence of aqueous vapor in the holder. This point has always appeared especially interesting, and therefore deserves further analysis here.

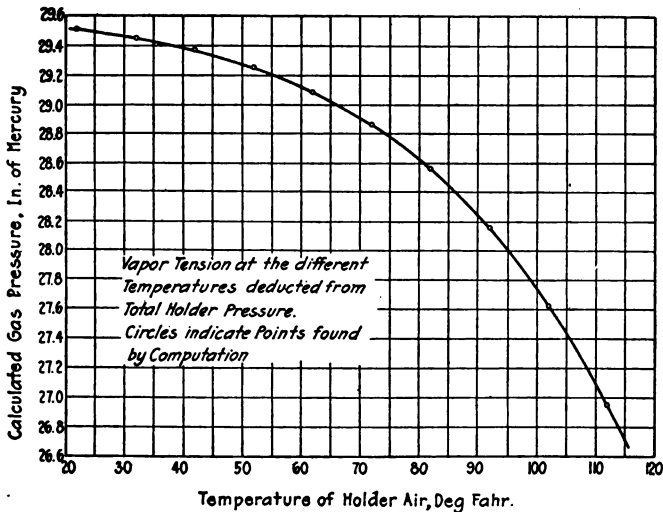

Fig. 43—CALCULATED "GAS PRESSURE" IN HOLDER WITH VARYING TEMPERATURE

That saturated water vapor was present in the holder air is evident. By Dalton's Law, it is correct to assume that the pressure inside the holder is made up of two distinct quantities (a) the tension of the saturated aqueous vapor, (b) the pressure of the air in the holder. The sum of these two component pressures, expressed as absolute, will be the barometer reading plus the reading of a U tube connected up to the holder pressure. Therefore, for a constant baro-

ORIFICE METER MEASUREMENT

meter, the total pressure of the holder will not change. If, however, the temperature should rise while the barometer remains constant, the tension of the saturated vapor will increase, and the second component of the total pressure, the pressure of the air (which will be called the "gas pressure" in this connection) must be correspondingly decreased. With varying barometer readings, this change in value of each component pressure will be different. However, a very close approximation can be had by basing all corrections on the average barometric reading at Joplin, viz., 29.3 in.

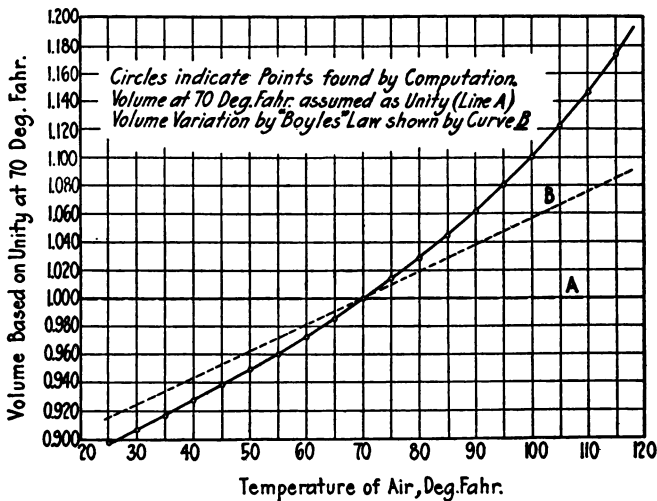

Fig. 44—CALCULATED VARIATION IN VOLUME OF AIR ENCLOSED IN HOLDER OVER WATER, WITH CHANGE OF TEMPERATURE

For any temperature, the second component of the total holder pressure—the gas pressure—can be found by subtracting from the total holder pressure the vapor tension for the temperature. The total pressure is the assumed

ORIFICE METER MEASUREMENT

barometric reading, 29.3 in., plus the observed pressure of the holder, 4.60 in. of water. The vapor tension for varying temperatures can be found in any handbook. Fig. 43 shows the variation of the gas pressure in the holder for temperature changes. The circles indicate points found by computation, and through these the curve is drawn.

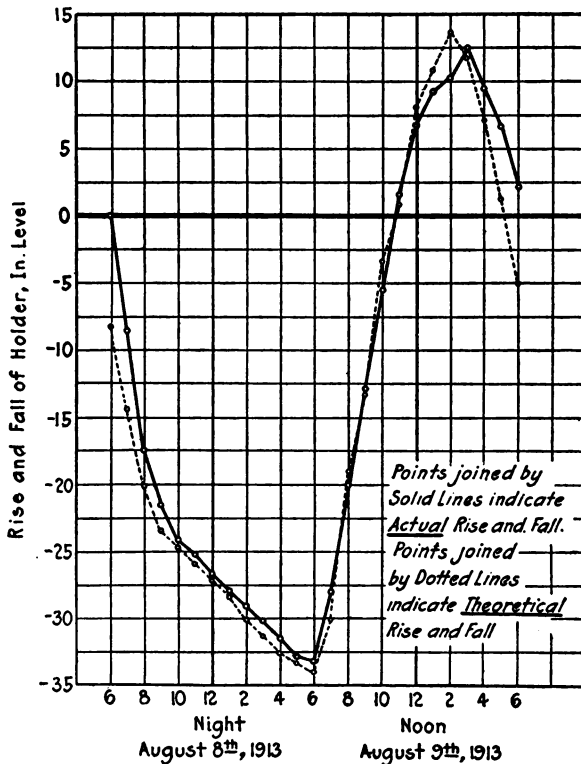

Fig. 45—ACTUAL AND THEORETICAL RISE AND FALL OF HOLDER UNDER TEMPERATURE CHANGES. FIRST 24 HR. TEST.

ORIFICE METER MEASUREMENT

Charles' law states that the ratio Pv/T is constant for a perfect gas. Under such small changes of pressure and temperature, air can be assumed a perfect gas. The value of the pressure corresponding with the temperature being known from Fig. 43, the volume can be found by calling the volume at any assumed standard temperature unity. In these calculations, the volume at 70 deg. fahr. is taken as unity. The full curve of Fig. 44 is the final result. Dotted in, for purposes of comparison, is a curve showing the Boyle's law

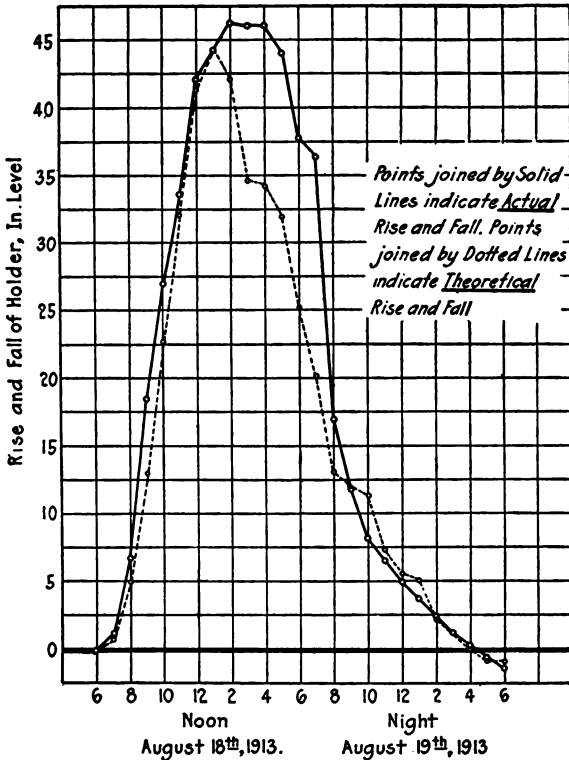

Fig. 46—ACTUAL AND THEORETICAL RISE AND FALL OF HOLDER, UNDER TEMPERATURE CHANGES. SECOND 24 HR. TEST.

variation for constant pressure. It can be seen at a glance that the volume variation under temperature changes, as observed at Joplin, is considerably more than it would be in the absence of the water vapor.

To go back to the test made on the holder to study the correction to be applied for varying temperatures, taking account of the effect of the vapor tension, as just explained, it was found in the study of the volume variation with temperature that the observed rise and fall of the holder during the test corresponded with a temperature change equal to the sum of two-thirds the atmospheric temperature, plus one-third the "top" temperature. This simply means, of course, that the average temperature of the holder air is that combination of the two observed temperatures.

Fig. 45 shows a test of the correctness of this average temperature of the holder air. The dotted curve shows the computed theoretical rise and fall of the holder, using the temperature correction just described, and based on the so-called "combined" temperature. The heavy curve shows the actual rise and fall observed. These two curves follow each other fairly well, except for a lag during the middle of the day. They bear the closest relation during the period between 9 P. M. and 6 A. M., when the effect of the sun shining down on the black holder top is not present. During the afternoon it is evident that the "top" temperature has a greater proportionate effect on the average temperature of the air in the holder than the "combined" temperature allows.

Fig. 46 shows curves of a similar nature for a second run made to check the results of the first run. The actual and theoretical rise and fall of the holder, plotted on the same scale over each other, again show very good agreement, particularly during the night. The lag during the hottest part of the day is again shown, in somewhat better shape, due to the fact that this second test was started at 6 A. M., while the first started at 6 P. M.

ORIFICE METER MEASUREMENT

Table 12—Readings and Calculated Results of a Sample Holder Test on Orifice Meter Disc.

Time	TEMPERATURES			Gauge Stick Reading	U-Tube In. Water	Calculated (Apparent) Displacement in 1/2 hr.	"Com-bined" Temp.	Correc-tion for Temp. Changes	Calculations
	At-mos.	Top	Ori-ifice						
8.15	66	66	66	252,675	4.39	8,625	66	0	Apparent total 108,975
8.45	67 1/2	...	65	244,050	4.39	7,700	66 3/4	330	
9.15	67	66	65	236,350	4.38				
9.45	66	...	64 1/2	228,125	4.37	8,225	66	-320	Seal water correction... -140 Leakage correction.... -650 Temperature correction. -960
10.15	66	64 1/2	64	219,725	4.36	8,400	65 1/2	-230	
10.45	66	...	64	210,950	4.36	8,775	65 1/2	0	
11.15	65 1/2	63 1/2	63 1/2	202,325	4.35	8,625	65	-210	Net Total..... 107,225 Average flow..... 8,248
11.45	65 1/2	...	63 1/2	193,700	4.35	8,625	65	0	
12.15	65 1/2	63	63 1/2	185,625	4.34	8,075	64 1/2	-200	
12.45	65	...	63 1/2	177,175	4.32	8,450	64 1/2	0	Calculated <i>C_a</i> 520 Calculated <i>C_v</i> 67.3%
1.15	65	63	63 1/2	168,850	4.30	8,325	64 1/2	0	
1.45	64 1/2	...	63	160,425	4.28	8,425	64	-170	
2.15	64	62 1/2	63	152,070	4.26	8,350	63 1/2	-160	Calculated <i>C_a</i> 520 Calculated <i>C_v</i> 67.3%
2.45	64	...	63	143,700	4.24	8,375	63 1/2	0	
			64		4.34	108,975	65	-960	

Test No. 227, Nov. 12, 1913. Orifice Disc No. 8301. Barometer 29.35 in.

Description of Procedure During Orifice Tests

Table 12 shows a sample page of the observations and calculated results of one orifice test. These tests were made with a flying start, that is, the air was started discharging through the meter orifice several minutes before the first tank level reading was taken. The final tank level reading was taken under similar conditions. Half-hourly readings of atmospheric temperature, "top" temperature, tank level, water level in seal, differential drop in inches of water across orifice disc, and the temperature of the discharged air were taken. To facilitate calculation, the tank level reading was taken by a gauge stick, marked off in cubic feet displacement. The exact diameter of the lower lift was found, and from this it was computed that a displacement of 100 cu. ft. corresponded with a holder drop of 0.1835 in. This 100 ft. graduation was the smallest on the gauge stick. The space could readily be divided visually into quarters, so the content of the holder at any moment could be read to the nearest 25 cu. ft. Differences between two consecutive half-hourly tank level readings would therefore give the uncorrected (or apparent) quantity of air passing out in that period. Preliminary corrections have to be applied to this value as follows: (1) holder leakage, at the rate of 100 cu. ft. per hr., (2) variation of the water level in seal, due to leakage out, evaporation, or pumping in of fresh water, (3) temperature change during test. With these corrections applied, the correct quantity of air passing through the orifice is obtained. This quantity, however, is expressed at holder pressure, and at some definite temperature, varying from day to day, i. e., the "combined" temperature. A reduction is necessary in order that the quantity of air passing through the orifice may be expressed in cubic feet at standard conditions of pressure and temperature, (29.4 in. of mercury or 14.41 lb. per sq. in., and 60 deg. fahr.).

ORIFICE METER MEASUREMENT

Table 13—Summary of Holder Tests on 8 in. Orifice Meters

Test No.	No. of Meter Disc	Date of Test and Duration in Hr.	Avg. Corr. Rate Cu. ft. in 30 min.	U-Tube Reading, In. Water	Barometer In. Mercury	Observed Temp.		Calc. C _a
						Flow	"Com-bined"	
201	8401	Sept. 25 1½	15,503	4.07	29.3	58	52	1.035
202	8501	26 2	25,361	3.31	29.3	62	56	1.868
203	8301	26 3	8,178	4.415	29.3	58	54	0.522
204	8351	27 3	11,671	4.26	29.3	62	60	0.752
205	8451	27 3	20,223	3.82	29.3	62	60	1.375
206	8451	28 2	20,589	3.79	29.2	64	61	1.409
207	8351	28 3	11,668	4.33	29.2	61½	60	0.747
208	8401	28 2½	15,796	4.11	29.2	61	58	1.041
209	8351	30 2½	11,850	4.31	29.3	66	62	0.759
210	8451	30 2	20,421	3.83	29.3	64	59	1.394
211	8501	2 1½	26,647	3.36	29.3	70	67	1.914
212	8501	2 1½	26,187	3.40	29.3	67½	63	1.883
213	8401	2 2½	15,839	4.14	29.3	65	60½	1.038
214	8301	3 2½	6,124	2.355	29.3	70	69	0.527
215	8301	4 5½	8,496	4.41	29.2	70	70½	0.532
216	8201	6 4½	3,579	4.52	29.2	68	65	0.2234
217	8201	7 4½	2,575	2.37	29.3	69	65	0.2217
218	8452	Nov. 3 2	18,989	3.37	29.4	58	55	1.387
219	8452	3 2½	18,772	3.42	29.4	57	54	1.358
220	8452	4 2	18,970	3.44	29.5	57	52	1.372
221	8452	4 2	18,791	3.44	29.5	55	49	1.361
222	8502	5 2	23,099	2.81	29.45	57	52	1.841
223	8502	5 1½	23,215	2.82	29.45	56	50	1.853
224	8502	5 1½	23,375	2.80	29.45	55	50	1.879
225	8201	6 5	3,641	4.52	29.3	60	59	0.2274
226	8301	11 3½	8,166	4.33	29.35	59½	58½	0.521
227	8301	12 6½	8,248	4.34	29.35	64	65	0.520
228	8502	13 2	23,485	2.80	29.4	63	64½	1.852
229	8201	14 5	3,566	4.53	29.45	64½	64½	0.2248
230	8201	15 4	3,560	4.585	29.3	54	49	0.2242
231	8352	Dec. 5 3	11,257	4.10	29.4	59	56	0.742
232	8601	6 1½	31,267	1.70	29.2	55½	46	3.273
233	8352	5 4	11,241	4.18	29.1	55½	48	0.746

ORIFICE METER MEASUREMENT

Table 14—Summary of Holder Tests on 8 in. Orifice Meters

Test No.	No. of Meter Disc	Date of Test and Duration in Hr.	Avg. Corr. Rate Cu. ft. in 30 min.	U-Tube Reading, In. Water	Baro-meter In. Mer-cury	Observed Temp.		Calc. C _a
						Flow	"Com-bined"	
234	8601	7 1½	30,478	1.65	29.5	51	33	3.293
235	8352	6 3½	11,319	4.09	29.2	55	46	0.762
236	8601	7 1½	30,463	1.65	29.5	51	31	3.306
237	8353	5 4½	11,161	4.08	29.4	59½	56	0.738
238	8502	7 1½	22,758	2.90	29.5	50	30	1.866
239	8601	30 1½	36,548	2.355	29.3	47	32½	3.305
240	8551	30 1½	31,023	2.99	29.3	48	33	2.487
241	8551	31 1½	30,942	3.00	29.2	50½	37	2.467
242	8571	31 1½	33,982	2.665	29.2	49	37	2.871
243	8571	Jan. 1 1½	29,408	1.965	29.0	53½	46½	2.865
244	8601	1 1½	31,093	1.64	29.0	53	45	3.325
245	8551	1 1½	27,337	2.30	29.0	52	40½	2.485
246	8352	2 3½	10,969	4.13	29.3	48½	30	0.752
247	8352	2 3½	11,148	4.31	29.3	48	27½	0.752
248	8551	3 1½	26,775	2.285	29.3	48½	31½	2.468
249	8601	3 1½	30,503	1.615	29.3	49½	32	3.344
250	8571	3 1½	28,495	1.96	29.3	48½	28½	2.853
251	8521	Feb. 16 1½	28,108	3.13	29.4	49	42	2.163
252	8251	18 3	5,684	4.62	29.1	47½	35½	0.3653
253	8251	19 3½	5,536	4.51	29.3	49	35	0.3599
254	8521	19 1½	28,075	3.22	29.3	47½	35	2.162
255	8151	20 9	1,877	4.63	29.4	52½	31	0.1216
256	8151	21 5½	2,144	4.63	29.7	56	49	0.1338
257	8151	23 9	1,802	4.61	29.6	46	12½	0.1196
258	8305	Mar. 4 3	8,101	4.49	29.4	52½	36	0.5275
259	8506	6 1½	23,425	3.00	29.5	49½	35½	1.865
260	8506	9 1½	23,617	2.96	29.4	52½	44	1.867
261	8473	25 1½	22,375	3.30	29.35	58½	64½	1.615
262	8474	25 1½	21,985	3.28	29.35	59	64½	1.595
263	8473	25 1½	22,162	3.28	29.4	59	62½	1.615

ORIFICE METER MEASUREMENT

Table 15—Summary of Holder Tests on 8 in. Orifice Meters

Test No.	No. of Meter Disc	Date of Test and Duration in Hr.	Avg. Corr. Rate Cu. ft. in 30 min.	U-Tube Reading, In. Water	Baro-meter In. Mer-cury	Observed Temp.		Calc. C_a
						Flow	"Com-bined"	
264	8474	Mar. 25 1½	22,045	3.27	29.4	59	63	1.607
265	8251	26 5	5,655	4.51	29.4	59	59	0.3532
266	8151	27 5½	2,048	4.59	29.35	63	59	0.1274
267	8251	30 6	5,780	4.52	29.4	62	63	0.3603
268	8151	April 1 6½	2,161	4.64	29.5	62	56½	0.1339
269	8251	2 5	5,590	4.50	29.5	61	59	0.3479
270	8171	6 5	2,742	4.62	29.3	59	55½	0.1696
271	8171	7 6½	2,564	4.61	29.55	54	36½	0.1644
272	8171	8 8	2,553	4.62	29.65	54	29	0.1658
273	8171	9 6	2,513	4.61	29.5	55	34½	0.1622
274	8151	18 6½	2,000	4.61	29.4	59	52	0.1253
275	8151	19 6	1,866	4.60	29.45	59	44	0.1188
276	8151	20 6½	1,998	4.59	29.4	64	60	0.1238

This corrected value of the quantity of air discharged, reduced to standard conditions of temperature and pressure, corresponds with the value Q in formula [4]. In this formula, as all the quantities but C_v are known, the latter can be calculated. The relation between C_v and C_a , as shown by equation [9], gives a means of obtaining this latter value. As stated earlier in the paper, the 15 min. air constant was the value calculated in all the Joplin tests. C_a is expressed in thousands of feet for 15 min.

Summary of Results of Tests

About one hundred and sixty tests on 8 and 10 in. orifice meter discs were run at Joplin during 1913-1914. A summary of the results of these tests is included in Tables 13 to 17 inclusive. A note on the system used in numbering the discs will make the summary self-explanatory. The first one or two

ORIFICE METER MEASUREMENT

Table 16—Summary of Holder Tests on 10 in. Orifice Meters

Test No.	No. of Meter Disc	Date of Test and Duration in Hr.	Avg. Corr. Rate Cu. ft. in 30 min.	U-Tube Reading, In. Water	Barometer In. Mercury	Observed Temp.		Calc. Ca	
						Flow	"Com-bined"		
401	10401	Dec. 20 3	13,978	4.345	29.4	48	32	0.9286	
402	10501		20 2	23,156	3.94	29.5	47	32½	1.611
403	10501		20 2	23,138	3.94	29.4	48½	31	1.620
404	10801	26 1	53,855	1.38	29.4	45	29½	6.384	
405	10751	21 1	49,513	1.89	29.5	48	33½	4.983	
406	10801	21 1	53,975	1.38	29.3	50	35	6.370	
407	10801	22 ½	55,595	1.43	29.2	48	36	6.429	
408	10751	22 1	50,575	1.95	29.2	49	35	5.025	
409	10501	23 2	23,209	3.95	29.2	49	32½	1.626	
410	10401	23 3½	14,189	4.38	29.2	48	33	0.9406	
411	10551	22 1½	29,042	3.89	29.2	48	35½	2.035	
412	10551	26 1½	28,225	3.68	29.4	45	26½	2.055	
413	10751	27 1	48,850	1.90	29.4	48	36½	4.976	
414	10801	27 ¾	55,220	1.39	29.4	49	37	6.450	
415	10501	27 2	21,080	3.28	29.4	49	35½	1.605	
416	10701	28 1	45,038	2.41	29.5	46½	35½	3.986	
417	10401	Jan. 5 3	13,990	4.31	29.4	43½	28½	0.9355	
418	10801		5 1	53,363	1.37	29.5	47	28½	6.368
419	10501	6 2	23,076	3.89	29.3	49½	39	1.604	
420	10651	6 1½	39,034	2.87	29.3	50	40	3.159	
421	10551	7 1½	28,593	3.65	29.1	53½	49½	2.025	
422	10601	7 1½	34,335	3.27	29.0	54	48½	2.581	
423	10751	7 1	50,320	1.89	29.0	55½	47½	4.997	
424	10551	8 1½	28,457	3.63	29.0	52½	46	2.035	
425	10601	8 1½	34,028	3.24	29.0	49	37½	2.613	
426	10601	8 1½	34,105	3.25	29.0	51½	43	2.592	
431	10771	17 1	50,952	1.61	29.3	51½	44	5.474	
432	10351	17 3½	10,890	4.39	29.3	53	44½	0.7067	
433	10601	18 1½	34,250	3.31	29.0	52	44	2.578	
434	10601	20 1½	33,983	3.27	29.2	52	42½	2.571	
435	10451	20 2½	18,172	4.16	29.2	50	38½	1.224	
436	10651	20 1	38,922	2.91	29.2	49	33	3.174	
437	10351	22 3½	11,028	4.44	29.0	57	57	0.7003	

ORIFICE METER MEASUREMENT

Table 17—Summary of Holder Tests on 10 in. Orifice Meters

Test No.	No. of Meter Disc	Date of Test and Duration in Hr.	Avg. Corr. Rate Cu. ft. in 30 min.	U-Tube Reading, In. Water	Barometer In. Mercury	Observed Temp.		Calc. C _a	
						Flow	"Combined"		
438	10651	Jan.	22 1¼	40,104	2.92	29.0	56½	57	3.147
439	10551		22 1½	14,412	3.68	29.0	57	56½	2.015
440	10551		23 1½	14,713	3.69	29.0	55	53½	2.063
441	10751		23 1	25,288	1.91	29.0	53	46	5.001
442	10701		23 1	45,510	2.39	29.0	52	40½	4.061
443	10701		24 1	44,938	2.35	29.2	47½	34	4.076
444	10801		24 1	53,895	1.36	29.2	46½	32½	6.432
449	10351		28 3½	11,101	4.44	29.0	60	62	0.7003
452	10451		31 2½	18,329	4.23	29.4	49½	36	1.226
454	10501	Feb.	1 2	23,345	3.93	29.3	50	43	1.603
456	10801		2 1	53,800	1.37	29.3	50	38	6.337
457	10351		2 3	10,805	4.37	29.3	51	40	0.7085
458	10801		3 1	53,863	1.38	29.4	48	33	6.361
459	10701		3 1	44,560	2.40	29.4	47	30	4.009
460	10351		4 4	10,751	4.46	29.2	47	31½	0.7074
461	10771		4 1	51,580	1.64	29.2	44	31½	5.590
462	10771		6 1	51,187	1.65	29.4	39	13½	5.695
463	10551		6 1½	27,538	3.76	29.4	39	7½	2.054
465	10621		11 1¼	36,934	3.12	29.3	53	48½	2.825
466	10621		11 1¼	36,742	3.11	29.3	51½	47½	2.818
467	10621		11 1¼	36,818	3.10	29.3	51½	46	2.836
477	10301	April	21 6	4,059	4.49	29.4	64	67	0.5019
478	10301		22 6	4,056	4.47	29.5	65	67	0.5102
479	10252		23 7	2,735	4.52	29.4	64	66½	0.3380
480	10301		25 6½	3,863	4.37	29.65	60	47	0.5043
481	10252		26 7	2,707	4.53	29.3	67	67	0.3354
482	10252		27 7	2,745	4.57	29.25	63	62	0.3409
483	10301		28 6	4,005	4.42	29.4	62½	56	0.5101
484	10301		29 6	3,990	4.48	29.6	62	53	0.5089
485	10301		30 6	3,931	4.49	29.6	61	53	0.4986
486	10252	May	1 6	2,701	4.53	29.4	62	55½	0.3412

ORIFICE METER MEASUREMENT

digits indicate the size of the pipe line in which the disc is inserted; the next two digits, the size of the orifice; the remaining digits, the serial number of the disc. For example, 8473 represents an 8 in. meter disc, $4\frac{3}{4}$ in. orifice; 104211 is a 10 in. meter disc, $4\frac{1}{4}$ in. orifice, etc. It was found necessary to discard perhaps half a dozen tests, on account of their disagreeing widely from the averages of the remainder. In two or three of these discarded tests, a shower or a fall of snow during the test furnishes a possible explanation; in other tests, no explanation was found.

It is worthy of special note that in these tests the standard used is an actual measurable volume, and not a standardized pitot tube or other indirect method of measurement. The advantage of being able to calibrate directly against displacement is a most important feature of these holder tests. A second feature of the tests is the ability to automatically secure a practically constant flow, without regulation of any kind.

Another point deserving mention is the fact that duplicate discs of sizes already tested at Joplin require no calibration of any kind. It is merely necessary to micrometer the orifice and to correct mathematically for any small deviation from the nominal diameter. For example, if a new 8 in. by 4 in. orifice disc micrometers 4.004 in. in diameter, and the result of the Joplin tests on the master 8 in. by 4 in. orifice be 1.034, the value of C_a for the slightly oversized disc would be $1.034 (4.004 \div 4.000)^2$ or 1.036.

The possibility of securing constants for duplicate discs without actual calibration is a great advantage, as will be realized. It means that sufficient time and effort can be spent in calibrating the master discs to secure the highest possible accuracy, without having the cost of an individual disc excessively high. That the method of calculating constants for new discs as described above is correct has been very well shown by careful checks made at Joplin.

Comparison of Results with Charlottenburg Tests

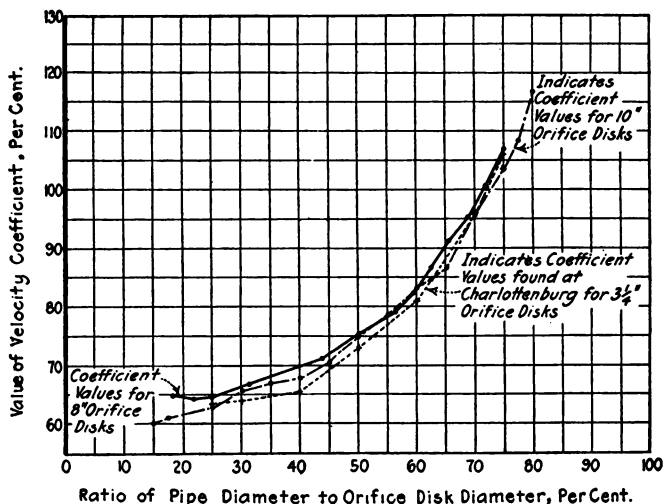

Fig. 47—COMPARISON OF VELOCITY COEFFICIENTS OF ORIFICE METER DISCS, AS FOUND IN JOPLIN TESTS FOR 8 IN. AND 10 IN. PIPE LINES, WITH VALUES FOUND AT CHARLOTTENBURG

Table 18—Summary of Values Plotted

Joplin 8 in.		Joplin 10 in.		Charlottenburg 3 1/4 in.	
d/D	C_v	d/D	C_v	d/D	C_v
0.1875	64.9	0.15	60.1	0.25	63.5
0.219	64.2	0.175	61.1	0.30	64.0
0.25	64.7	0.25	62.8	0.40	65.5
0.3125	66.9	0.30	65.6	0.50	73.0
0.375	67.9	0.35	66.9	0.60	81.0
0.4375	71.1	0.40	67.9	0.70	96.0
0.50	75.3	0.45	70.4	0.75	106.0
0.5625	79.0	0.50	74.9
0.594	82.2	0.55	78.7
0.625	86.6	0.60	83.2
0.655	91.3	0.625	84.6
0.6875	95.3	0.65	86.6
0.7187	100.7	0.70	95.9
0.75	107.0	0.75	103.5
.....	0.80	116.6

ORIFICE METER MEASUREMENT

The only published report* of tests made on orifice discs similar to those tested at Joplin gives the values of the velocity coefficient, C_v (as used in the fundamental formula) for $3\frac{1}{4}$ in. pipe found in tests made at Charlottenburg, Germany. Fig. 47 shows graphically the values found at Charlottenburg compared with the Joplin results for 8 and 10 in. pipe. The Joplin curves agree fairly well with the Charlottenburg values, especially if the difference in the pipe size is taken into account."

ERIE HOLDER TESTS

A subsequent series of calibrations was run in 1915 to supplement the large capacity meters previously developed by the addition of a series of relatively small capacity meters in 6 in. and 4 in. pipe. The reference quantity chosen for this work was a small holder located at the testing plant of the Metric Metal Works, Erie, Pa. Check tests were also taken with 8 in. and 10 in. pipe line orifices; in all about 130 determinations were made covering the following orifices.

Table 19

No.	Size of Pipe, In.	Size of Orifices In.	No.	Size of Pipe, In.	Size of Orifices, In.
4051	4	0.506	6204	6	2.002
4071	4	0.755	6302	6	3.003
4103	4	0.996	6401	6	4.000
4123	4	1.250	8101	8	1.010
4154	4	1.500	8205	8	2.006
4174	4	1.754	8304	8	3.006
4205	4	1.997	8451	8	4.500
4223	4	2.251	8506	8	5.005
4251	4	2.504	10151	10	1.500
4301	4	3.002	10302	10	3.007
6101	6	1.002	10451	10	4.502
6151	6	1.502	10601	10	5.999

* Zeit. des Ver. d. Ing., Feb. 23, 1908.

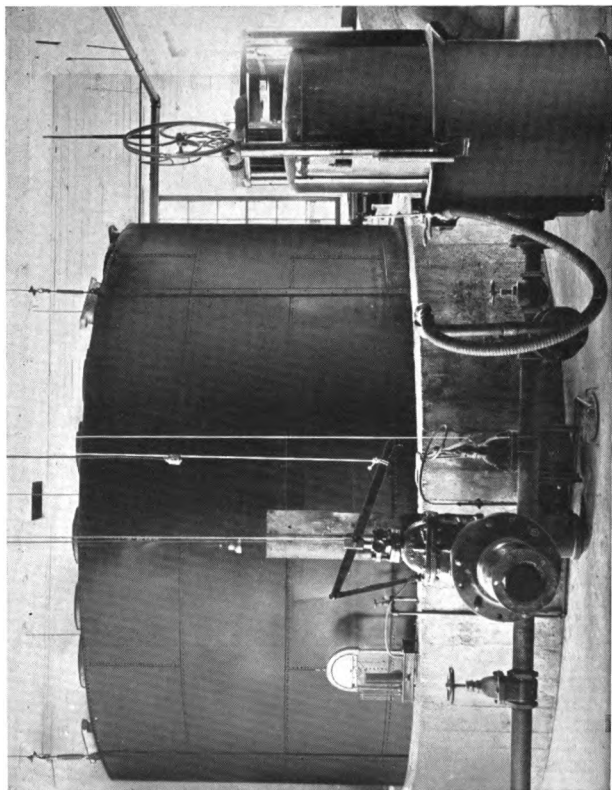

Fig. 48—HOLDER AND TESTING ROOM, METRIC METAL WORKS

ORIFICE METER MEASUREMENT

Table on Page 102 gives data for determination of leakage in the holder and lines. This gives a leakage correction factor for these tests and the dimensions of the holder. Table on Page 103 is a recapitulation of the derivation of the formula used in determining the air constant in this series of tests. The following is a key to the tabulation employed on the following pages.

Column	Data
1	Date of Test
2	Size of Disc
3	Barometer in inches of mercury.
4	Feet Drop of Holder, each foot drop is equivalent to displacement of 200 cu. ft.
5	Time in Seconds taken by stop-watch.
6	P_h Holder pressure (lb. per sq. in., absolute).
7	T_h Temperature of holder air, deg. fahr.
8	T Temperature of flowing air, deg. fahr.
9	h Differential across disc inches of water.
10	P Absolute pressure, in lb. per sq. in. on inlet side of disc.
11	C_a Fifteen-minute air constant for disc.
12	C_v Velocity coefficient per cent.

Tables 20 and 21 are specimen sheets showing a summary of determinations made on various orifices in 6 in. pipe.

Leakage Test, August 7, 1915—The readings and calculated results given here show Leakage Test made to ascertain rate of leakage from holder, so proper allowance could be made. This test was started about noon on a Saturday and ran until early Monday morning.

Time

Start 11:30 a. m. Aug. 7, 1915.

Finish 7:00 a. m. Aug. 9, 1915.

ORIFICE METER MEASUREMENT

Readings	Temperature of Holder deg. fahr.	Reading of Tape
Start	70	26.0
Finish	71	25.85

Leakage (without any allowance for change of temperature during test): 0.15 ft. drop in $43\frac{1}{2}$ hr. This is equivalent to 0.0115 cu. ft. per min. Leakage (with temperature correction made):

0.0130 cu. ft. per min.

Calculated Volume of Holder, August 10, 1915

Measured Diameter of Holder Top (Outside).

16' 0.5"; 16' 0.1"; 15' 11.8"; 15' 11.9"; 15' 11.7";

16' 0.1"; 15' 11.7"; and 16' 0.0"

Average 15' 11.975"

Allowance for thickness of metal

2 thickness No. 16 gauge iron 0.125"

Inside Diameter 15' 11.850"

or 15.988 ft.

Calculated area = 200.76 sq. ft. which means that one foot drop of holder displaces 200.76 cu. ft. The nominal capacity is 200 cu. ft. per ft. drop; the actual capacity is therefore $\frac{3}{8}$ of 1 per cent above the theoretical.

This error of $\frac{3}{8}$ of 1 per cent in holder capacity is ignored in the calculation of all tests given in this report. It exactly counter-balances an error of $\frac{3}{8}$ of 1 per cent in stop watch.

Measured Circumference of Holder

Near Top 50' $3\frac{3}{4}$ "

Near Middle 50' 4"

Near Bottom 50' $4\frac{1}{2}$ "

ORIFICE METER MEASUREMENT

Derivation of General Formula for Calculating Holder Tests on Orifice Meter Discs.

Q = quantity measured under standard conditions of pressure and temperature, i. e., 60 deg. fahr. (520 deg. absolute) and 14.41 lb. per sq. in.

Subscript h means actual conditions of air or gas in holder. This will vary from day to day, even for the same holder.

Assuming Flow Temp. of 60 deg. fahr.

$$Q = C_a \sqrt{h P} \text{ for air,}$$

$$\text{or } = C_a \sqrt{\frac{h P}{G}} \text{ for gas.}$$

At any other Flow Temp. T

$$Q = C_a \sqrt{\frac{h P \times 520}{T G}}$$

Furthermore

$$Q_h \times \frac{520}{T_h} \times \frac{P_h}{14.41} = Q$$

$$Q_h \times \frac{520}{T_h} \frac{P_h}{14.41} = C_a \sqrt{\frac{h P \times 520}{T G}}$$

$$C_a = \frac{Q_h P_h}{14.41 T_h} \sqrt{\frac{520 T G}{h P}}$$

In this general formula derived above, there are substituted special values for reducing quantity and time of test giving.

$$C_a = 284.6 \frac{\text{Tape Difference (in ft.)}}{\text{Number of Sec.}} \frac{P_h}{T_h} \sqrt{\frac{T}{h P}}$$

ORIFICE METER MEASUREMENT

Table 20—Summary of Erie Tests on 6 in. Orifice Meter Discs—August, 1915

1	2	3	4	5	6	7	8	9	10	11	12
8-17-15											
1	6302	29.4	6	231.0	14.63	531	529	4.645	14.57	0.5677	72.8
2	6302	29.4	6	232.7	14.63	531	529	4.56	14.57	0.5692	73.0
3	6302	29.4	6	253.5	14.63	531	529	3.86	14.54	0.5676	72.8
4	6204	29.4	4	367.9	14.63	531	529	5.17	14.59	0.2253	65.0
5	6204	29.4	3	292.2	14.63	531	529	4.37	14.57	0.2313	66.6
6	6204	29.4	3	317.5	14.63	531	529	3.685	14.55	0.2315	66.9
7	6204	29.4	4	365.5	14.63	531	529	5.17	14.59	0.2252	65.0
8	6204	29.4	3	276.2	14.63	531	529	5.115	14.59	0.2255	65.0
9	6204	29.4	3	290.5	14.63	532	531	4.43	14.57	0.2312	66.9
10	6204	29.4	1	94.7	14.63	532	531	4.855	14.58	0.2256	65.3
11	6204	29.4	1	95.6	14.63	532	531	4.61	14.58	0.2294	66.4
12	6204	29.4	1	94.6	14.63	532	531	4.74	14.58	0.2293	66.4
13	6401	29.4	8	166.1	14.63	532	530	3.12	14.52	1.286	92.7
14	6401	29.4	8	169.7	14.63	532	530	2.98	14.51	1.291	93.0
15	6401	29.4	8	194.3	14.63	532	530	2.26	14.49	1.296	93.3
16	6401	29.4	8	165.6	14.63	532	530	3.13	14.52	1.289	92.9
17	6151	29.4	1.450	239.8	14.63	532	531	5.295	14.59	0.1239	63.6
18	6151*	29.4	1.343	240.6	14.63	532	531	4.465	14.58	0.1243	63.8
19	6151	29.4	1.135	240.4	14.63	532	531	3.19	14.52	0.1245	63.9
20	6151	29.4	1.070	240.5	14.63	532	531	2.84	14.51	0.1245	63.9

ORIFICE METER MEASUREMENT

Table 21—Summary of Erie Tests on 6 in. Orifice Meter Discs—August, 1915

	1	2	3	4	5	6	7	8	9	10	11	12
8-18-15												
1	6101	29.4	1.0	384.2	14.63	528	527	5.29	14.60	0.05345	61.6	
2	6101	29.4	1.0	425.0	14.63	528	527	4.35	14.56	0.05331	61.6	
3	6101	29.4	1.0	470.4	14.63	529	528	3.55	14.53	0.05326	61.6	
4	6101	29.4	1.0	556.9	14.63	529	528	2.54	14.48	0.05332	61.6	
5	6101	29.4	1.0	652.0	14.63	529	528	1.815	14.45	0.05397	62.3	
6	6204	29.4	1.7	154.6	14.63	530	529	5.19	14.60	0.2278	65.7	
7	6204	29.4	1.0	94.6	14.63	530	529	4.69	14.58	0.2306	66.7	
8	6204	29.4	1.0	98.6	14.63	531	529	4.30	14.57	0.2306	66.7	
9	6204	29.4	1.0	105.1	14.63	531	529	3.715	14.55	0.2325	67.4	
10	6204	29.4	1.0	111.7	14.63	531	530	3.28	14.54	0.2330	67.5	
11	6204	29.4	1.0	121.6	14.63	531	530	2.765	14.52	0.2334	67.6	
12	6204	29.4	1.2	165.7	14.63	531	530	2.165	14.51	0.2326	67.4	
9-2-15												
1	6204	29.6	6.3	573.0	14.71	532	530	5.16	14.71	0.2278	65.7	
2	6204	29.6	3.5	356.0	14.71	532	530	4.05	14.67	0.2305	66.7	
3	6204	29.6	2.0	235.0	14.71	532	530	2.99	14.60	0.2325	67.4	
4	6204	29.6	1.4	202.4	14.71	532	530	1.99	14.58	0.2323	67.3	
5	6204	29.6	1.0	195.8	14.71	532	530	1.09	14.55	0.2313	67.0	
6	6204	29.6	1.2	199.7	14.71	532	530	1.49	14.56	0.2333	67.7	
7	6204	29.6	1.2	245.5	14.71	532	530	1.00	14.55	0.2315	67.1	
8	6204	29.6	1.2	219.6	14.71	532	530	1.235	14.56	0.2331	67.6	
9	6204	29.6	1.4	267.4	14.71	532	530	1.12	14.55	0.2345	68.0	
10	6401	29.6	7.9	161.4	14.71	535	533	3.14	14.63	1.304	93.9	
11	6401	29.6	7.7	158.0	14.71	535	533	3.12	14.63	1.301	93.7	
12	6401	29.6	6.8	156.8	14.71	535	533	2.505	14.61	1.296	93.3	
13	6401	29.6	6.3	172.0	14.71	535	533	1.82	14.59	1.285	92.6	

ORIFICE METER MEASUREMENT

It will be noted that there are a few minor changes in the coefficients in the Tables in Part 4.

These changes are very slight and are caused by some errors in the original work.

Status of Coefficient

Fig. 50 shows the degree of variation under the conditions of the different tests, and the solid black line is an averaging line on which coefficients for actual use at the present time are based.

All the orifice calibration work, up to and including the Erie tests, has been compiled and reduced to a basis shown in Pages 108 and 109, showing the "coefficient of velocity" for all sizes of pipe plotted on a basis of the ratio of diameters of orifice to diameters of pipe.

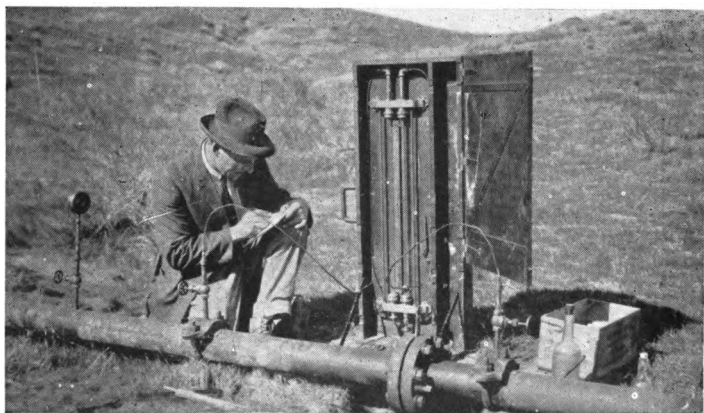

Fig. 49—ORIFICE FLANGE METER AND LIGHT PORTABLE DIFFERENTIAL GAUGE, PIPE TAP CONNECTIONS

ORIFICE METER MEASUREMENT

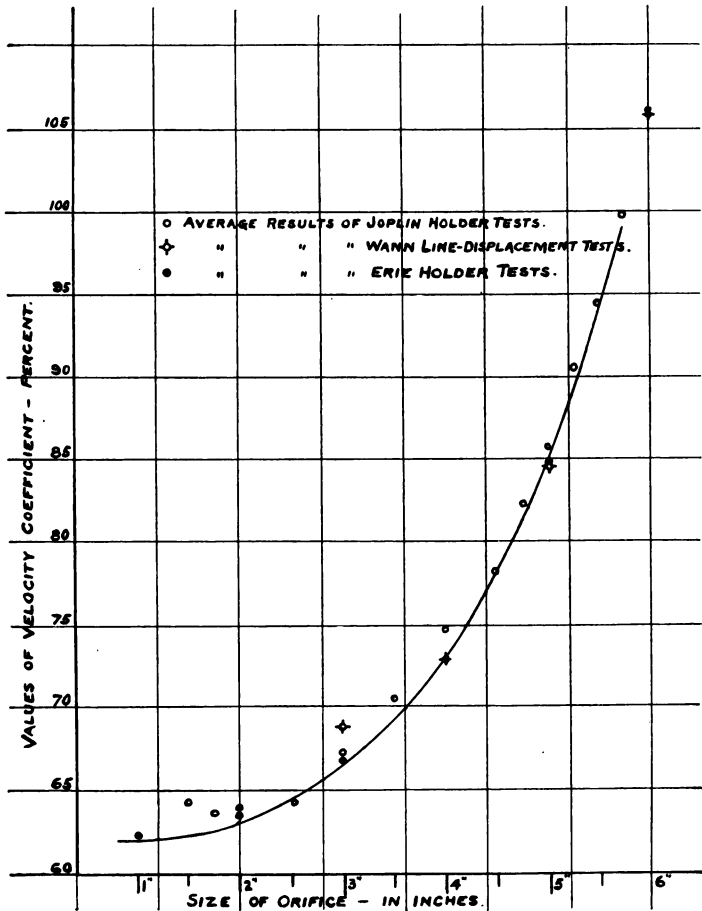

Fig. 50

ORIFICE METER MEASUREMENT

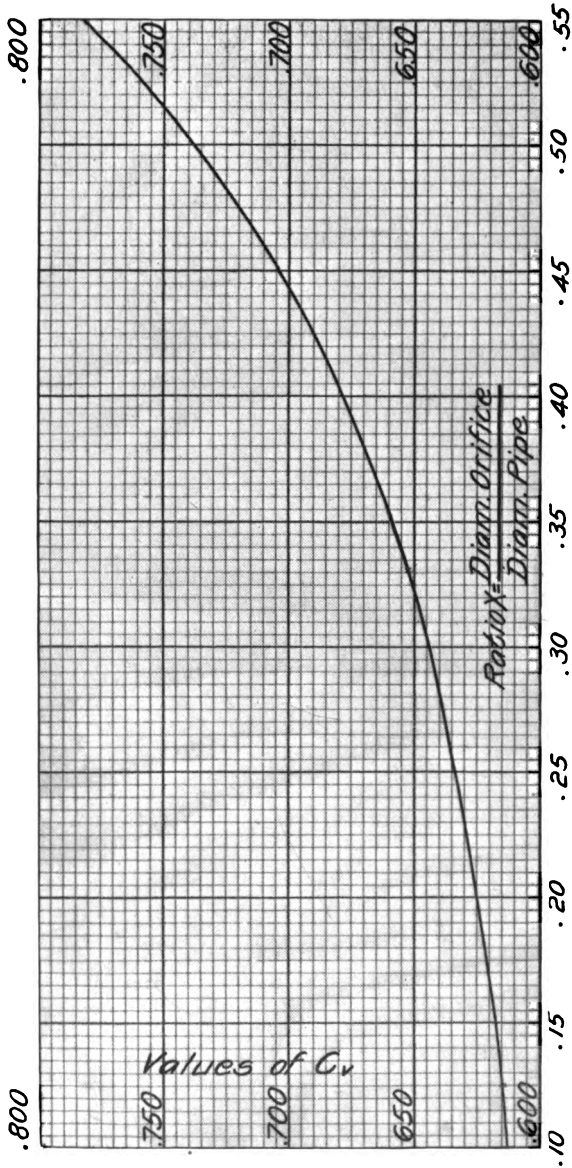

Fig. 61

ORIFICE METER MEASUREMENT

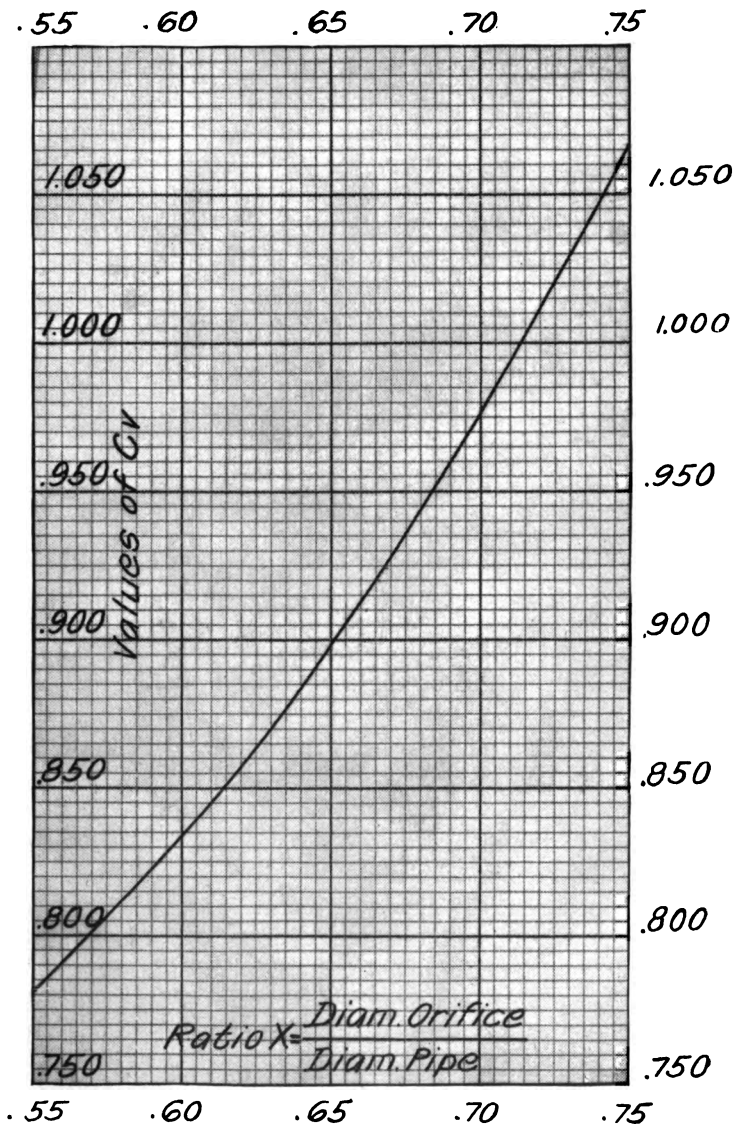

Fig. 52

It is the belief of the author that this value may be safely applied within the limits of accuracy shown by the curve to any practicable size of pipe line without further question. The number of experiments which are incorporated in it, and the great variety of conditions under which it has been developed, have practically eliminated any personal equation of observational error of any individual test or series of tests.

MEASURING FLOW OF FLUIDS

The relation between the differential and the velocity of the fluid through the orifice is expressed by the formula:

$$V = C_v \sqrt{2gH}$$

where V = velocity of flowing fluid in feet per second.

g = acceleration due to gravity in feet per sec.

H = differential expressed in feet head of flowing fluid.

As it is not practical to register this value directly, the differential is recorded on the chart in inches of water pressure.

C_v = Coefficient of Velocity. It is the ratio of the actual velocity to the theoretical velocity of fluid passing the orifice. Its value depends upon the ratio of the diameter of the orifice to the diameter of the pipe, and the location of pressure connections with respect to the orifice.

The Coefficient of Velocity is the same for the same ratio of diameter of orifice to diameter of pipe, i. e., the value of C_v for a two inch orifice in a four inch pipe* is the same as for a three inch orifice in a six inch pipe or a four inch orifice in an eight inch pipe. These coefficients do not bear a simple mathematical relation to the ratios of diameters but they increase as the ratio of diameter of orifice to diameter of pipe

* Actual Dimension.

increases. A two inch orifice in a three inch pipe has a greater coefficient than a two inch orifice in a four inch pipe. The reason for this is that the nearer the size of the orifice approaches the size of the pipe line the more closely the flow approaches a jet effect and vice versa. With a small orifice in a large pipe the effect produced is nearer that resulting from passing the fluid through a small opening in a drum or storage tank.

When the pressure connections are located at the flange the values of the "coefficient of velocity" are lower than when placed farther from the flange.

The values of C_v for various ratios, diameters of orifices and pipes are given on Pages 108 and 109. They apply for any fluid, whose viscosity is equal to or less than the viscosity of water.

As the Hourly Orifice Coefficient varies with the "coefficient of velocity" it is changed by any change affecting this factor.

The following examples illustrate the application of the modified formula $V = C_v \sqrt{2gH}$ to the flow of various gases and liquids through a pipe line. It is not practical to use this method of computation for routine work but the solution of the examples demonstrate the fundamental principles of orifice meter flow.

EXAMPLE—Air being measured; atmospheric pressure, 14.4 lb.; line or static pressure, 28.8 lb.; temperature, 60 deg. fahr.; diameter of orifice, 2 inches; diameter of pipe, 4.026 inches; differential, 17 inches of water; pressure connections at $2\frac{1}{2}$ and 8 diameters from orifice.

Absolute Pressure $P = 14.4 + 28.8 = 43.2$ lb. per sq. in.

Absolute Temperature $T = 60 + 460 = 520$ deg. fahr.

$$\text{Ratio } X = \frac{\text{Diameter of Orifice}}{\text{Diameter of Pipe}} = \frac{2.000}{4.026} = .497$$

ORIFICE METER MEASUREMENT

C_v for a ratio of .497 = .736 (Page 108).

$$H = \frac{1000hT}{520PG} = \frac{1000 \times 17 \times 520}{520 \times 43.2 \times 1} = 394 \text{ feet of air at 43.2 lb.}$$

absolute at 60 deg. fahr. (Page 64.)

$$V = C_v \sqrt{2gH} = .736 \sqrt{2 \times 32.16 \times 394} = 117.2 \text{ ft. per sec.}$$

Area of 2 inch Orifice = .0218 sq. ft. (Page 75)

The quantity per second equals the area of the orifice in square feet multiplied by the velocity in feet per second.

Quantity = .0218 \times 117.2 = 2.55 cubic feet per second at 43.2 lb. absolute, at 60 deg. fahr.

$$\text{Quantity based on 14.4 lb. per sq. in.} = \frac{2.55 \times 43.2}{14.4} =$$

7.65 cubic feet per second.

Quantity per hour = 7.65 \times 60 \times 60 = 27,500 cu. ft. at atmospheric pressure.

EXAMPLE—Gas being measured; period, 24 hours; pipe line, 4 inches (actual inside diameter 4.026 inches); diameter of orifice, $2\frac{5}{8}$ inches; average differential pressure, 54 inches of water; atmospheric pressure, 14.5 lb.; line pressure, 105.5 lb.; Pressure Base, 8 oz. above atmospheric pressure; Base and Flowing Temperature, 60 deg. fahr. Specific Gravity, 0.60; pressure connections at $2\frac{1}{2}$ and 8 diameters from orifice.

$$\text{Ratio } X = \frac{\text{Diameter of Orifice}}{\text{Diameter of Pipe}} = \frac{2.625}{4.026} = .652$$

C_v for a ratio of .652 = .901 Page 109.

Flowing Temperature = 460 + 60 = 520 deg. fahr. absolute.

Static or Line Pressure = 105.5 + 14.5 = 120 lb. per sq. in. absolute.

Pressure Base = 0.5 + 14.5 = 15.0 lb. per sq. in. absolute.

ORIFICE METER MEASUREMENT

$$H = \frac{1000hT}{520PG} = \frac{1000 \times 54 \times 520}{520 \times 120 \times .60} = 750 \text{ feet head of air at 120}$$

lb. absolute at 60 deg. fahr. Page 64.

$$V = C_v \sqrt{2gH} = .901 \sqrt{2 \times 32.16 \times 750} = 197.9 \text{ feet per sec.}$$

Area of $2\frac{5}{8}$ inch Orifice = .03758 sq. ft. (Page 75).

Quantity per second equals area of orifice multiplied by the velocity = $.03758 \times 197.9 = 7.44$ cubic feet of gas per second at 120 lb. per square inch absolute.

$$\text{Quantity, at 15 lb. per square inch absolute} = \frac{7.44 \times 120}{15} =$$

59.5 cu. ft. per second; for 24 hours = 24 hours \times 60 minutes \times 60 seconds \times 59.5 cu. ft. per second = 5,140,000 cu. ft. per day.

In these examples it is noted that the differential when expressed in feet head of flowing gas or air is decreased as the pressure increases and that the volume when expressed at a Pressure Base is increased as the static pressure increases.

EXAMPLE—Water being measured; diameter of orifice, 2 inches; diameter of pipe, 4 inches (standard); differential, 1.84 inches of mercury (pressure connections and U gauge above mercury filled with water); pressure connections at $2\frac{1}{2}$ and 8 diameters.

$$\text{Ratio diam. of orifice to diam. of pipe, } X = \frac{2.00}{4.026} = .497.$$

C_v for ratio .497 = .736. (Page 108).

Inasmuch as the gauge and gauge connections are filled with water, each inch of mercury differential is offset by an inch of water so that 1 inch of mercury indicates only 12.6 inches of water pressure differential due to flow. Therefore, the pressure differential is $1.84 \times 12.6 = 23.2$ inches of water. See Page 38.

$$H = \frac{23.2}{12} = 1.93 \text{ feet head of water.}$$

$$V = C_v \sqrt{2gH} = .736 \sqrt{2 \times 32.16 \times 1.93}$$

$$V = 8.20 \text{ feet per second.}$$

$$\text{Area of Orifice} = .0218 \quad (\text{Page 75}).$$

$$\text{Quantity} = .0218 \times 8.20 = .179 \text{ cu. ft. per second.}$$

Therefore, the quantity per hour = $.179 \times 7.48 \times 3600 = 4820$ gallons per hour, where one cu. ft. equals 7.48 gallons.

EXAMPLE—Oil being measured; diameter of orifice, 2 inches; diameter of pipe, 4.026 inches; differential, 1.84 inches of mercury, gauge lines and gauge filled with oil; Baume gravity, 30 degrees; viscosity, 25 seconds Saybolt. (In this case the viscosity of the oil is less than that of water and therefore the coefficient of velocity for the oil is the same as coefficient of velocity for air.

$$\text{Ratio } X = \frac{\text{Diameter of Orifice}}{\text{Diameter of Pipe}} = \frac{2.000}{4.026} = .497$$

$$C_v \text{ for } .497 \text{ ratio} = .736 \quad (\text{Page 108})$$

As the specific gravity of this oil is .875 compared with water, each inch of mercury = $13.6 / .875 = 15.54$ inches of oil, but each inch of mercury differential is offset by a pressure equal to one inch of oil and therefore, each inch of mercury differential indicates $15.54 - 1.00$ or 14.54 inches of oil differential. Therefore, the differential pressure = $1.84 \times 14.54 = 26.8$ inches of oil = 2.23 ft. See Page 38.

$$V = C_v \sqrt{2gH} = .736 \sqrt{2 \times 32.16 \times 2.23} = 8.81 \text{ feet per sec.}$$

Quantity = $.0218 \times 8.81$ feet per second = $.192$ cubic feet per second = 691 cubic feet per hour = $691 / 5.615$ or 123 barrels per hour, where 5.615 cubic feet equals one barrel.

In the case of oil and water the amount measured is dependent only on the differential. The pressure does not produce any effect on the volume or the differential.

To simplify all calculations for orifice meter measurement the values of H (the differential in feet head of flowing fluid), have been expressed in terms of inches of water differential for liquids and in terms of inches of water head and pressure in pounds per square inch absolute for air, gases and vapors. The multipliers used, the area of the orifice and units of measurement are combined in one term, for the conditions of flow at any orifice. This term is known as the Hourly Orifice Coefficient C , which is used in the following simple formulae. It is the volume per hour at a one inch differential (in cases of gases at 1 lb. per square inch absolute).

For gases $Q = C\sqrt{hP}$.

For liquids $Q = C\sqrt{h}$.

Where Q = quantity per hour expressed in weight or volume.

C = Hourly Orifice Coefficient. This value does not change for any orifice when measuring fluids of the same specific gravity. The coefficient for an orifice of any commercial size for gas, air, steam, water, oil, etc., are contained in the tables in this volume.

h = the differential pressure existing between the two pressure connections expressed in inches of water head, this value being recorded graphically on the chart of the recording differential gauge.

P = the static pressure expressed in absolute units, being equal to the atmospheric pressure plus the gauge pressure (which is recorded on the chart). The value of the gauge pressure is also recorded on the chart.

In measuring liquids the static pressure is ignored as liquids are nearly incompressible.

ORIFICE METER MEASUREMENT

Extensions of the value of \sqrt{hP} for differential pressures from 1 to 100 inches water head and for all static pressure ranges from 29 inches mercury vacuum to 500 lb. gauge pressure are contained in the book, "Pressure Extensions," published by this company.

For a detailed explanation of the above formulae and their application to the measurement of air, gas, steam and liquids, the reader is referred to the Parts 4, 5, 6, and 7.



Fig. 53—DIFFERENTIAL GAUGE, 10 INCH DIFFERENTIAL RANGE

MERCURY FLOAT TYPE DIFFERENTIAL
GAUGES

As iron weighs approximately .26 lb. per cubic inch, and mercury weighs approximately .49 lb. per cubic inch—iron will float in mercury. This makes a very desirable combination for a differential gauge, as the mercury is a very sensitive liquid and will not freeze above a temperature of 40 deg. fahr. below zero.

The mercury float type differential gauge is primarily a U tube made of semi-steel and steel in which mercury is used as a seal. A cast iron or steel float which floats in the mercury is placed in either the high or low pressure column of the U tube and is connected by a lever and shaft (working through a stuffing box) with the pen arm. The pen of the pen arm records on a chart which is rotated by clock work.

Some of the gauges are constructed with the one column of the U tube surrounding the other column. Fig. 35 illustrates such a gauge in which the high pressure column surrounds the low pressure column and in which the float rests in the mercury in the low pressure column. Fig. 54 illustrates a type of gauge which resembles the ordinary U tube. In this type also the float rests in the mercury in the lower pressure column.

The line pressure upstream from the orifice is admitted to column **H** and the downstream pressure to column **L**, so that both columns are under line pressure. The recording parts, clock, etc., which are contained in the case, are under the atmospheric pressure.

In Fig. 54 when the pen is in the zero position the float is raised about one-eighth inch above the bottom of the column **L**. As the pressure in column **H** increases over the pressure in column **L**, the mercury lowers in column **H** and rises in column **L**, raising the float. The rise and fall of the float is transmitted by the lever and shaft to the pen arm which indicates on the chart the rise and fall of the mercury

in the column in which the float is placed. The charts used are graduated in inches of water differential to indicate the difference of pressures acting in the columns of the gauge. For each 13.6 inches of water differential the difference in the elevation of mercury in the two columns is one inch. For 27.2 inches of water the difference is 2 inches of mercury, etc., so that for each inch increase of water differential recorded on the chart the increased difference in the mercury levels of the two columns is .0735 inch. Therefore, for a 20 inch water differential the difference in mercury levels is 1.47 inches. At the zero position the surfaces of the mercury in the two columns are on the same level but due to the difference in areas of the columns, the mercury in the column **H** will fall more rapidly than it will rise in column **L**. For instance, if column **L** is four times the area of column **H**, for each inch of mercury differential the mercury will fall .8 of an inch in column **H** while it rises .2 of an inch in column **L**. This is necessarily so because the volume of mercury displaced in the one column must be equal to the volume of mercury added to the other column. In differential gauges where the chambers or columns are uniform in area throughout the column, each equal increase of differential will cause an equal increase in rise in the column **L** and consequently, an equal increase in rise of the float. Providing the arc over which the float joint travels is small the pen attached to the differential arm will travel over equal spaces on the chart for equal increases of mercury differential.

The pressure which causes the float to rise is equal to the area of the float multiplied by the distance through which the mercury rises for each increase in differential by the weight of mercury per cubic inch, and the force which tends to overcome the friction of the shaft in the stuffing box is equal to this pressure multiplied by the length of the float lever. Therefore, it is evident that the larger the float and the longer the lever the more force there is to overcome the

ORIFICE METER MEASUREMENT

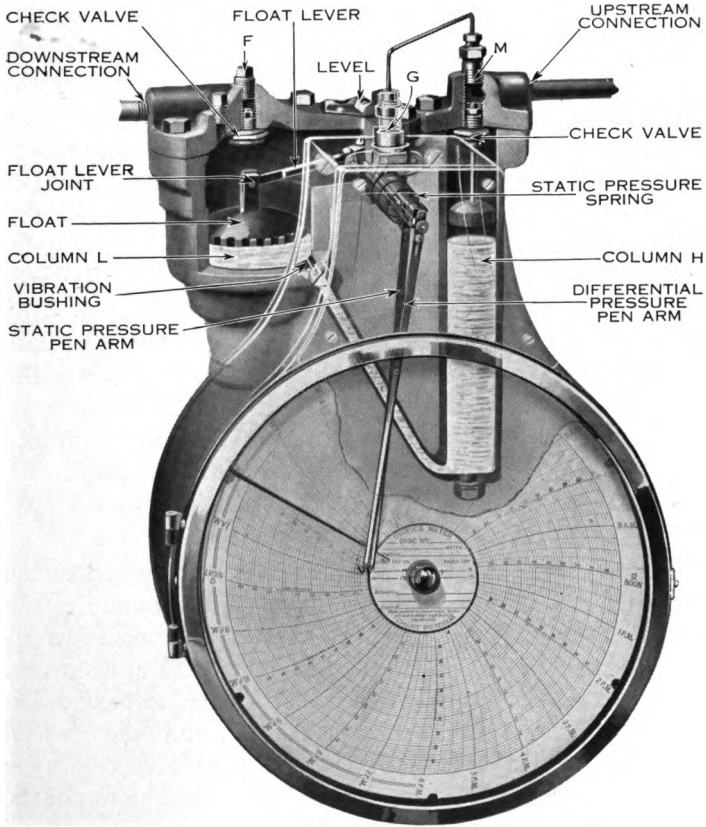

**Fig. 54—SECTIONAL VIEW OF A 100 INCH DIFFERENTIAL AND
STATIC PRESSURE GAUGE**

THE 50 INCH GAUGE IS SIMILAR IN DESIGN

friction of the stuffing box, hence greater sensitiveness. There must be friction in stuffing boxes as it is the friction only which prevents leakage. The friction in the stuffing box may be reduced by using a smaller pin through the stuffing box but there is a limit to the size of this pin due to the bending effect which may be caused by the weight of the pen arm.

Due to the fact that the travel of the pen is proportional to the rise of the float and the length of the float lever, if when checking a gauge against a water column, at zero check the pen is on the zero line and at 20 inches on the water column the pen rests on the 19 inch line, and when the water column indicates 40 inches, the pen is slow and rests at 38 inches, it is evident that a reduction of the effective length of the float lever will cause the pen arm to move more rapidly. If the distance between the float joint and the shaft is decreased by one twentieth (in this case) the pen will record correctly. The mercury will always register the proper differential, but the levers, etc., may not be in proper adjustment to indicate correctly in inches of water.

All mercury float type gauges which are exposed to the elements, are subject to temperature variations due to the fact that the mercury expands when the temperature increases, and contracts when the temperature decreases. This statement also applies to steel. The cubical expansion of mercury for 1 deg. fahr., is .000099, and the cubical expansion of steel is .000017, so that the difference between cubical expansion of mercury and of steel causes a rise of the mercury for a 50 degree increase in temperature which will produce a movement on the pen arm in a 50 inch gauge, equivalent to $\frac{1}{6}$ of 1 inch of water pressure and vice versa. If a gauge of this type is set on zero in the cool part of the day and the temperature of the mercury rises 50 degrees during the day, when the gauge is again checked for zero at the time when the temperature is the greatest the pen arm

will be about $\frac{1}{6}$ of an inch above the zero line. From the above it may be thought that this error could be eliminated by using less mercury, but in all types of gauges which use lesser quantities of mercury, the area of the chambers is also decreased, or the ratio of the rise of the float to the movement of the pen arm, is decreased, so that the net effect on all gauges is approximately the same. The error due to a 50 degree change of temperature will make a difference equivalent to one-third of one per cent of the maximum range of the gauge. Therefore, to eliminate this discrepancy the gauge should be sheltered and protected from extreme temperature changes.

ACCURACY OF ORIFICE METER

The Orifice Meter and its Differential Gauge are like the Large Capacity Meter. When given proper attention they will give results as accurate as any measuring instrument known.

A great many users have the impression that the orifice is the main part of the meter and therefore cannot "get out of order." While it is true that the orifice itself will not easily change its diameter or shape or "get out of order," the Differential Gauge is a **delicate recording instrument and must be checked periodically and kept in good condition**, free from condensation. In addition to this it is very important that the coefficient be based on the true conditions of the gas or liquid measured.

The weighing or measuring device that will not become inaccurate at some time or other has not been invented. Even the measuring rule will shrink as it grows older.

Another point that is seldom considered by users of Orifice Meters, is that when a differential gauge is out of adjustment and the pen arm reads too low or too high, the error is not expressed in percentage figures.

ORIFICE METER MEASUREMENT

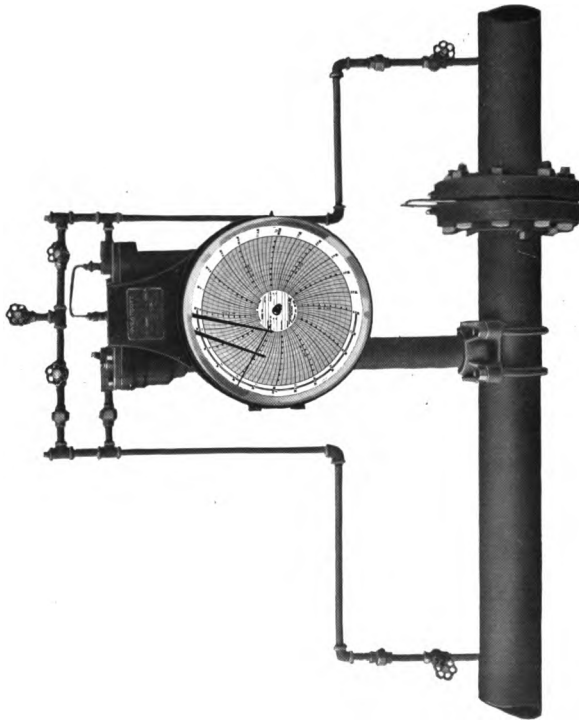

Fig. 65—50 OR 100 INCH DIFFERENTIAL GAUGE INSTALLATION

ORIFICE METER MEASUREMENT

For instance, if the differential pen arm records two inches in error, it is spoken of as merely two inches too high or too low, and the error is seldom expressed in per cent. The percentage of error due to a differential pen arm recording too high or too low is dependent on whether the differential pressure is ranging around a low or a high value. If the differential pressure should average 10 inches of water pressure and the pen arm should be found to be recording two inches too high or too low, the error would be 12 per cent fast or 9 per cent slow. While if the differential pressure should range between 40 and 44 inches of water pressure with the same error of 2 inches in the differential pen arm the error would be about 2.5 per cent.

The error due to an erratic static pressure pen arm or a static pen arm that records too low or too high can likewise be expressed in percentage figures. The percentage fast or slow varies according to the static pressure of the gas measured. It is greatest for low pressure and smallest for high pressure. If the static pressure pen arm reads 2 lb. high at atmospheric pressure, the percentage fast would be 6.7. If the static pressure ranges around 400 lb. and the static pen arm records 2 lb. high, the error would be 0.24 per cent fast.

From the foregoing the reader will note there is greater necessity of having both the static and differential pen arms recording more accurately at low pressures than at high pressures.

In addition to any error from an erratic static or differential pen arm, the error constantly exists if the coefficient is not revised for the true conditions, for instance, specific gravity when measuring gas. If the orifice coefficient is based on a specific gravity of .6 and the true specific gravity of the gas measured is .65, the result would be 4 per cent too high, or if the coefficient was based on a specific

ORIFICE METER MEASUREMENT

gravity of .65, and the true specific gravity of the gas was .6, the result would be 4 per cent too low.

To give an example where all three errors occur:

Assume that the differential pen arm was marking two inches high and the static pressure pen arm was marking two pounds high, also that the true gravity of the gas was .70 instead of .65 upon which the coefficient was calculated.

Using an hourly coefficient of 1000, differential 12 inches of water, and static pressure 12 lb., then the formula would read:

$$100\sqrt{12(14.4+12)} = 17,799 \text{ cu. ft.}$$

With the differential pen arm marking two inches

too high, deduct.....	8 per cent
With the static pen arm marking two lb. too high, deduct.....	4 per cent
To correct for true gravity of gas from .65 to .70, deduct.....	4 per cent

	16 per cent.
--	--------------

$$17,799 \times 84\% = 15,051 \text{ cu. ft.}$$

To prove error, change formula to read with correct pressures:

$$100\sqrt{10(14.4+10)} = 15,621 \text{ cu. ft.}$$

To correct this result for change in specific gravity from .65 to .70:

$$15,621 \times .9636 = 15,052 \text{ cu. ft.}$$

In giving the foregoing or following facts and figures it is not the intention of the author to discredit the accuracy of the Orifice Meter as a measuring instrument, but to put forth the true facts in such a light that the orifice meter users will fully understand what the different errors mean in percentage figures, and to create a better understanding of this type of meter, that greater accuracy may be obtained.

ORIFICE METER MEASUREMENT

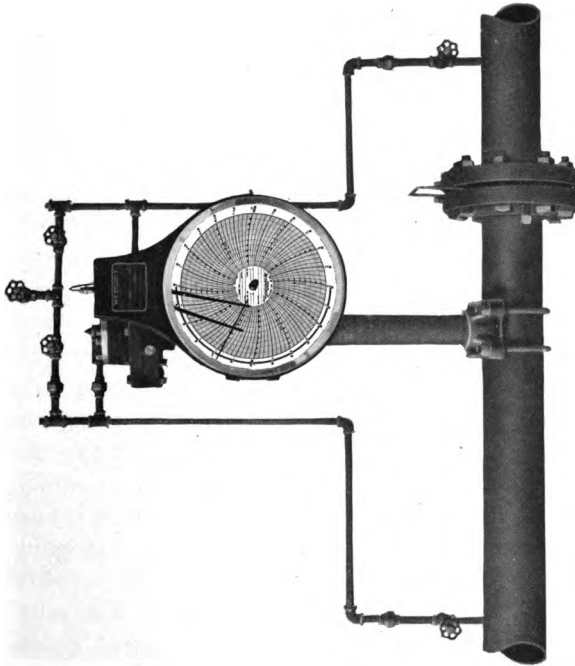

Fig. 56—80 INCH DIFFERENTIAL GAUGE INSTALLATION

ORIFICE METER MEASUREMENT

Table 22
DIFFERENTIAL GAUGE CAPACITIES

Capacity ranges of Differential Gauges. Same Orifice and Pipe.
Hourly Orifice Coefficient 100.

Maximum Reading Chart Inches	Maximum Capacity	Closest Reasonable Reading Inches	Minimum Chart Reading* Inches	Minimum Capacity	Ratio of Maximum to Minimum Flow
100	1000	0.4	8.0	283	3.5
50	707	0.2	4.0	200	3.5
25	500	0.1	2.0	141	3.5
20	447	0.08	1.6	127	3.5
10	316	0.04	0.8	89	3.5
2.5	158	0.01	0.2	45	3.5

*Minimum chart reading corresponds to a 2½ per cent deviation in results for the closest reasonable reading.

The above Table is self explanatory and is given to illustrate the capacity relations of various ranges of gauges, also the fact that the ratio of maximum to minimum flow is the same regardless of the maximum differential range of the chart, when we use the same standard for determining the minimum chart reading which ultimately is the limit of ordinary vision. The maximum capacity for a 100 inch gauge is twice as great as for a 25 inch gauge, but it is likewise true that the minimum capacity of the 100 inch gauge is also twice as great. The relative capacities are based on an Hourly Orifice Coefficient of 100 for water. The relations shown are the same for any liquid, or a gas at a definite pressure.

DIFFERENTIAL RANGE

There are many who advocate the 50 inch differential pressure range, and many who prefer the 100 inch range. It is the intention of the author to give the advantages and disadvantages of each pressure range in the following paragraphs.

ORIFICE METER MEASUREMENT

The first differential gauge placed on the market carried a metallic spring instead of a mercury pot, and a 100 inch differential pressure range. It was generally conceded that the 100 inch pressure range for that type of differential gauge was the best. Manufacturers advised that this type of gauge gave best service working at a range from 40 inches to 60 inches. The range from 60 inches to 100 was only used in case of an emergency, or when there was an extreme rise in the differential pressure, in which case the pressure range above 60 inches acted as a factor of safety to the spring.

The mercury type of differential gauge superseded the spring type, and in itself acts as a safety valve to take care of any extreme rise of differential pressure. To illustrate this:—

Take a 100 inch differential spring type gauge—should the differential pressure increase to 75 inches, the spring would not be affected. Of course, this differential pressure would mean a drop in the pressure in the gas or liquid passing through the meter of about $2\frac{3}{4}$ lb. for small sizes of orifices.

Should this same rise in differential pressure occur with a spring type gauge with a pressure range of 50 inches, the spring would break, putting the gauge out of commission.

With the 50 inch range of the mercury type differential gauge in which the mercury acts as a seal or safety valve, the gauge would not be injured by the rise in pressure above 50 inches, as the pen would be checked at fifty inches.

In measuring a certain volume of gas where a 100 inch differential pressure gauge is used, 71 per cent of the volume is measured by the first fifty inches and 29 per cent by the second 50 inches or that part of the range between 50 inches and 100 inches. However, the maximum capacity of a 100 inch gauge is 41 per cent greater than a fifty inch gauge. See article on Capacities, Page 126.

When measuring fluids in high pressure lines where the loss of pressure is not an objectionable factor, and where large

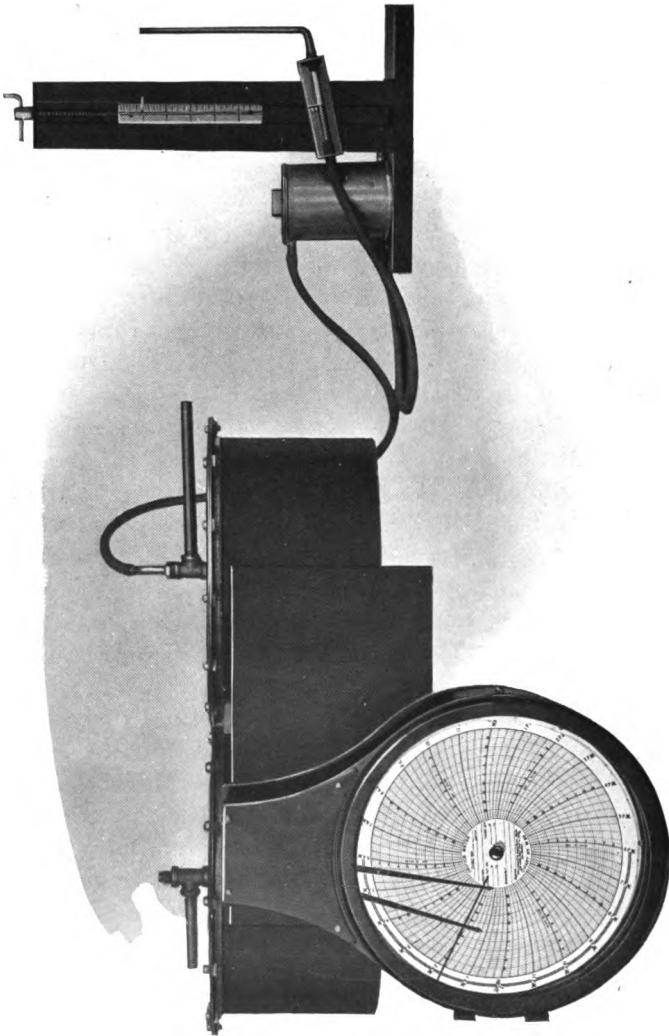

Fig. 57—DIFFERENTIAL GAUGE, $\frac{3}{4}$ INCH DIFFERENTIAL RANGE. OIL USED AS A LIQUID INSTEAD OF MERCURY. USED FOR MEASURING AIR OR GAS WHERE PRESSURE IS NEAR ATMOSPHERIC

capacity is desired a 50 or 100 inch gauge should be used. For casinghead gas and all vapors and liquids when the line pressure is less than 50 lb. per sq. in., gauges having a 10 or 20 inch maximum differential range should be used. For gas and air lines where the pressure is nearly atmospheric, a $2\frac{1}{2}$ inch gauge will give excellent results with an extremely low friction loss.

SPECIAL TYPES OF DIFFERENTIAL GAUGES

Differential Gauge, $2\frac{1}{2}$ inch Range—This particular type of gauge, which uses oil instead of mercury as a seal, is especially adaptable for the measurement of gases under pressures which do not vary appreciably from the atmospheric pressure. As noted on Page 126 the range of this gauge from maximum to minimum is the same as any differential gauge. The great advantage in this gauge being that the pressure loss occasioned at the orifice to produce a reasonable reading is very slight, not amounting to more than one inch of water pressure on the average.

Combination Gauge—Gauges have been placed on the market which have a 0 to 25 inch differential range or 0 to 100 inch differential range using the same gauge. This gauge is especially adaptable to locations where the flow varies for certain periods, and where it is undesirable or inadvisable to change the orifice in order to obtain a reasonable reading. By using this type of gauge, the operator can increase the range of the same orifice for reasonable readings from $3\frac{1}{2}$ to 1, to 7 to 1, without any change of orifice whatever. For instance, if for a period of a month the hourly flow varies from 100,000 to 350,000 feet per hour and during the subsequent month the flow decreases and varies between 50,000 and 175,000 per hour, it is possible to make the entire change in the gauge without any change of the orifice, thus eliminating any breaking of the line.

This change is made by simply interchanging the bushings or plugs which are used in the high pressure mercury chamber and thus decreasing or increasing the area of the pot. The working parts are not disturbed at all. A 25 inch chart is used when the 25 inch bushing is in place, and the 100 inch chart is used when the 100 inch bushing is in place. This type can be used to great advantage in measuring steam, water and oil where by-passes are undesirable. Page 325.

Indicating Gauges—Gauges have been designed which have doors made of one sheet of metal in which a diagram is placed under glass in the section of the door under which the differential pen arm moves. This diagram is slotted and contains a scale between the slots on which is indicated the rate of flow per hour corresponding to various pressures. The operator by simply noting the static pressure at which the gauge is working and by following the arc on the diagram can determine the flow per hour on the scale reading over the differential pen arm. These gauges indicate the rate of flow within 3 per cent. They are especially adaptable for those locations where it is desirable to change the rate of flow by increasing or decreasing the pressure and differential. Due to the various State Regulations, etc., it is necessary to draw at a uniform rate from the wells and quite frequently, due to the sudden increase in demand, it is necessary to increase the rate of flow. The office man simply tells the field man to increase the flow from 100,000 to 200,000 providing the field man has been passing 100,000 feet per hour and the field man is able to make this change without any calculations on his part whatever, simply by increasing the pressure and differential and noting the scale reading opposite the differential pen arm.

The doors of the gauge are made standard so that they can be used to replace doors on other gauges now in use.

These indicating gauges are especially desirable for measuring steam or oil.

ORIFICE METER MEASUREMENT



Fig. 58—DIFFERENTIAL GAUGE WHICH INDICATES RATE OF FLOW PER HOUR. IN MEASURING GAS THE RESULT IS READ IN CUBIC FEET PER HOUR. THIS DOES AWAY WITH THE NEED OF PRESSURE EXTENSIONS TO DETERMINE THE RATE OF FLOW. SEE PAGE 299.

Patent applied for.

Recording Differential and Static Pressure and Temperature Gauge—These Differential and Static Pressure Gauges are equipped with recording thermometer so that the flowing temperature of the gas is recorded on the same chart as the differential and static pressure. Gauges of this character can be used to advantage on large gas mains where it is desired to make a correction for the amount of flowing gas according to temperature of the gas. The temperature is recorded inside of the zero differential circle of the chart. The benefit of having the three records on one chart is obvious. See Page 234.

DEVIATION IN FLOW DUE TO HIGH RATIO OF DIFFERENTIAL TO PRESSURE

In all of the calculations relative to flow of fluids through orifices the general formulae and expressions of flow have been simplified and are based on the assumption that the difference between the upstream pressure and the downstream pressure is small when compared with either the upstream or the downstream pressure, or that the ratio of the differential to the pressure is small.

In measuring fluids which are nearly incompressible, such as water or oil through an orifice meter, there is practically no change in the density as the fluid passes the orifice. The quantity is correctly represented by the formula $Q = C\sqrt{h}$ when the velocity is less than the critical velocity.

When measuring compressible fluids such as air, natural gas, artificial gas, hydrogen, etc., the density of the fluid is changed. The quantity flowing is based on the velocity which is obtained by calculating the formula $V = C_v \sqrt{2gH}$, where H is the differential expressed in feet head of flowing fluid. The value of H varies and depends on the line pressure. Theoretically it is assumed that the line pressures at both connections are the same but this is not true due to the differential created by the orifice. As the ratio of the differential to the line pressure increases, the greater will be

ORIFICE METER MEASUREMENT

the difference in values of the differential in feet head of flowing fluid when expressed in terms of the upstream and downstream pressure.

Velocity at Orifice in feet per sec.	Deviation of calculated result, from true result, in per cent.	Velocity at Orifice in feet per sec.	Deviation of calculated result, from true result, in per cent
900	17.0	500	8.2
800	14.8	400	6.0
700	12.6	300	3.8
600	10.4		

Recently a series of 30 tests was conducted in which the ratios of differential to the downstream pressure varied from 10 per cent to 100 per cent. A holder was used as a standard of measurement. Deviations in percentage of the calculated volumes, using the published Coefficients of the orifices, from the actual volume were plotted for two types of connections, one where pressures were obtained at pipe connections (static pressure at the downstream connection) and the other where the pressures were obtained at the flanges (static pressure at the downstream connection). These deviations were plotted against the actual velocity of the air through the orifice and indicated that the percentage deviation for either of the types of connections was the same for the same rate of flow in feet per second, being plus for the upstream static pressure connection and minus for the downstream static connection.

The number of tests are too meager to indicate or develop a formula or curve for a series of multipliers to be used when high ratios of differential to pressure exist. On account of the varying value of the coefficient of velocity, it is impossible to give definite factors from the data obtained for various ratios of diameter of orifice to diameter of pipe.

All of the published Coefficients were based upon experimental data obtained by using orifices in which the ratio of

ORIFICE METER MEASUREMENT

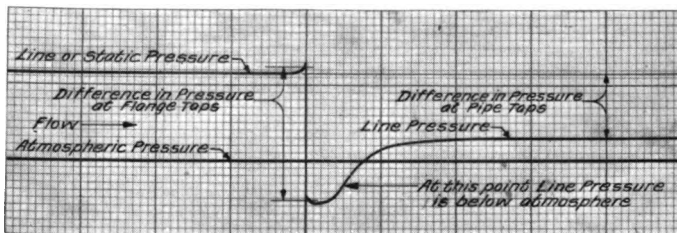
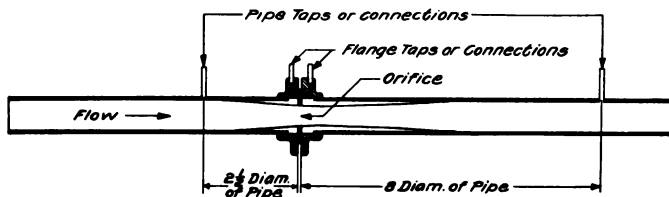

Fig. 59—SKETCH SHOWING STREAM FLOW THROUGH AN ORIFICE AND THE RELATIVE STATIC PRESSURES AT VARIOUS POINTS LONGITUDINAL SCALES ARE THE SAME

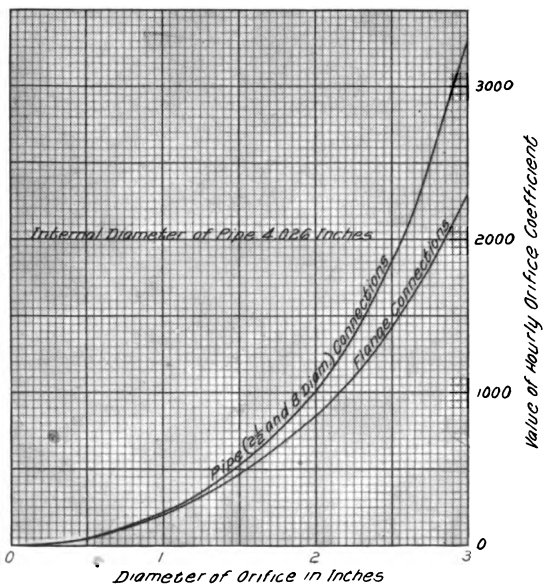

Fig. 60—HOURLY ORIFICE COEFFICIENTS FOR 4 IN. LINE FOR AIR

differential to pressure was low. These Coefficients should be used in a similar manner in actual practice and should not be used under exceptional conditions as above indicated without the use of multipliers or factors, which cannot be furnished at present. It is recommended that the reading on the differential gauge in inches of water should seldom exceed twice the value of the static pressure in pounds per square inch absolute for any type of connections in order to obtain accurate results without the use of multipliers, that is, the average maximum differential pressure should not exceed, 10 inches at 20 inches mercury vacuum (5 lb. abs.), 50 inches at 10 lb. (24.4 lb. abs.), etc.

PRESSURE CONNECTIONS OR TAPS

When the main pipe taps are made at points $2\frac{1}{2}$ diameters upstream and 8 diameters downstream from the orifice, these connections are called Full Flow Connections and quite frequently are known as Pipe Taps. When the taps for the pressure connections are made close to the orifice, through the flanges, the taps are called Flange Taps. See Fig. 59. In the $2\frac{1}{2}$ and 8 diameter or Pipe Tap installation, the connections are made at points where the stream line flow occupies the full section of the pipe, hence the descriptive term Full Flow Connections. These points were chosen by the first experimenters as being the points at which the differential would be approximately the least and the most consistent that could be obtained by any combination of points. In other words, the line pressure at a point $2\frac{1}{2}$ diameters upstream is the least pressure that exists upstream from the orifice, and the pressure at a point 8 diameters downstream is the greatest uniform pressure which exists below the orifice. The point of maximum downstream pressure is about 6 diameters downstream from the orifice.

Where the pressures are obtained at the flanges, the upstream pressure is slightly greater than the minimum upstream pressure, and the pressure at the downstream con-

nection is slightly greater than the least downstream pressure (in the vicinity of the orifice). The least pressure (near the orifice) exists about $\frac{4}{10}$ of the pipe diameter downstream from the orifice.

From the above facts it follows that the differential pressure between connections at the flanges is always greater for the same velocity through the same orifice (See Fig. 59) than that obtained at the Pipe Taps, (one connection $2\frac{1}{2}$ diameters upstream and the other 8 diameters downstream). In other words, the differential obtained between taps at the flanges is an exaggerated differential.

When taps are made in the flanges for connections the openings must be located with precision as a small variation in the distance from the flanges produces an appreciable change in the differential due to the fact that the pressure varies at points within $\frac{1}{4}$ of a diameter of the orifice. At the points for Full Flow Connections a variation of an inch in the location does not produce a readable effect, for the reason that the pressures at these points and at points within a diameter in either direction are steady and do not vary appreciably.

Friction Loss—The following Table gives the percentages of friction loss to total differential for Full Flow and Flange Connections for various ratios of orifice to size of pipe.

Table 23
Percentage of Friction Loss to Differential

Ratio X <u>Diameter of Orifice</u> <u>Diameter of Pipe</u>	Full Flow Connections Per Cent Loss	Flange Connections Per Cent Loss
.15	100	96
.30	100	89
.45	100	75
.60	92	57
.75	80	40

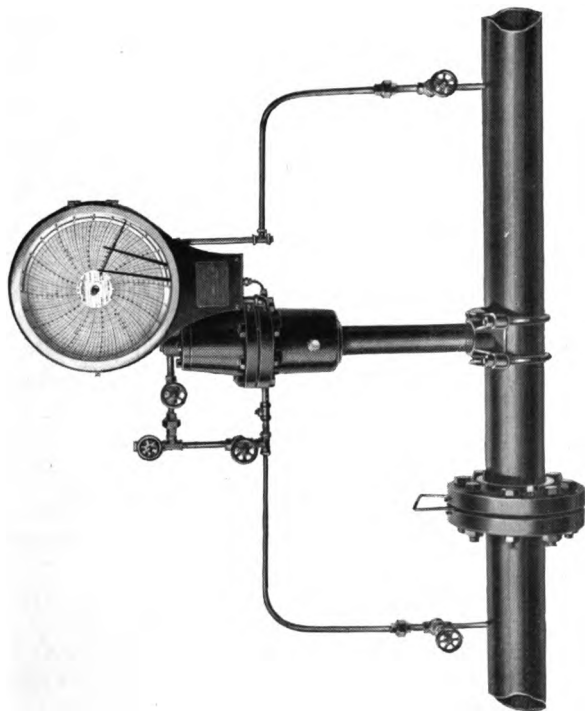

Fig. 61—ORIFICE FLANGES AND 60 INCH DIFFERENTIAL GAUGE INSTALLATION

The friction loss at a $2\frac{3}{4}$ inch orifice in a 6 inch line for a 50 inch differential reading is 100 per cent or 50 inches with Full Flow Connections, and 38 inches when the same differential is obtained when using the same orifice with Flange Connections. If a $4\frac{1}{2}$ inch orifice is used in a 6 inch pipe the friction loss at 50 inch differential reading is 40 inches, and 20 inches for the Full Flow Connections and Flange Connections respectively. This relation may be expressed as follows. With Full Flow Connections the differential is $1\frac{1}{4}$ times the friction loss and with Flange Connections the differential is $2\frac{1}{2}$ times the friction loss at an orifice which is $\frac{3}{4}$ of the diameter of the pipe. It is noted that the friction loss percentage decreases as the size of the orifice increases.

At a first glance it would seem that the Flange Connections are preferable, but it is a self evident fact that with a definite rate of flow through an orifice the friction loss will be the same as long as the same orifice is used in the same pipe. The loss does not depend on whether the pressures are obtained at a mile away on each side of the orifice or within $\frac{1}{8}$ inch.

Table 23 does not tell the whole story for it does not take into consideration the larger value of the coefficient for the Full Flow Connections when using the same size of orifice in the same pipe. See Fig. 60.

In Table 24 it is shown that for the same size of orifice the Hourly Orifice Coefficient for Pipe Tap connections is always greater than the Hourly Orifice Coefficient for Flange Tap connections and that for the larger sizes of orifices the Pipe Tap coefficient becomes considerably greater than the Flange Tap coefficient. In order to indicate the same flow the differential reading on the chart of the gauge attached to the flange taps reaches its maximum limit (20 inches), when the pen of the other gauge is registering at one-half of its maximum range, (10 inches). The friction loss in each case is the same for the same flow.

ORIFICE METER MEASUREMENT

Table 24

Comparison between two 20 inch Differential Gauges, measuring the same flow through the same orifice (one with Pipe Tap connections and the other with pressure connections at the flanges) when the gauge connected to the Pipe Taps is indicating a 10 inch reading.

Dia- meter of Ori- fice Inches	Quan- tity	Gauge with Connections at Pipe Taps			Gauge with Connections at Flange Taps		
		Coeffi- cient	Chart Read- ing Inches of Water	Fric- tion Loss Inches of Water	Coeffi- cient	Chart Read- ing Inches of Water	Fric- tion Loss Inches of Water
$\frac{5}{8}$	836	83.6	10	10	81.8	10.5	10
$1\frac{1}{4}$	3506	350.6	10	10	327.4	11.5	10
$1\frac{3}{4}$	7382	738.2	10	10	642.5	13.2	10
$2\frac{1}{2}$	18562	1856.2	10	9	1429.8	16.8	9
3	32962	3296.2	10	8	2322.7	20.0	8

Size of Pipe 4.026 inches. Pressure 10 lb. absolute.
Air being measured.

Table 25

Comparing two 50 inch gauges, one with Full Flow Connections and the other with Flange Connections each indicating a differential of 25 inches, (except as noted). Size of Pipe 4 inches. Air being Measured. Pressure 16 lb. Absolute.

Full Flow Connections				Flange Connections			
Dia- meter of Orifice Inches	Hourly Orifice Coeffi- cient	Quan- tity cu. ft. per hour	Fric- tion Loss Inches Water	Dia- meter of Orifice Inches	Hourly Orifice Coeffi- cient	Quan- tity cu. ft. per hour	Fric- tion Loss Inches Water
$\frac{5}{8}$	83.6	1672	25	$\frac{5}{8}$	81.8	1636	24
$1\frac{1}{4}$	350.6	7012	25	$1\frac{1}{4}$	327.4	6548	22
$1\frac{3}{4}$	738.2	14764	25	$1\frac{3}{4}$	642.5	12850	19
$2\frac{1}{2}$	1856.2	37124	23	$2\frac{1}{2}$	1429.8	28596	14
$2\frac{3}{4}$	2481.9	49638	21	3	2322.7	46454	10
3	3296.2	65924	20	3	2322.7	65690*	20

*At 50 inches differential

ORIFICE METER MEASUREMENT

In Table 25 it is shown that for various quantities of gas passing the same orifice at the same differential, the friction loss is less for Flange Connections but the quantity is also less, also that in order to measure the same maximum quantity that the gauge with Full Flow Connections measures at a 25 inch reading, the gauge with Flange Connections must indicate at the limit of the chart in which case the pressure loss is the same.

The following table shows very clearly that a gauge of a certain maximum range with Full Flow Connections will measure the same or slightly greater quantities at the same relative chart reading with a less friction loss than a gauge of double its maximum range with Flange Connections.

Table 26

Comparison between a 50 inch gauge with $2\frac{1}{2}$ and 8 diameter connections and a 100 inch gauge with Flange Connections, each gauge indicating a differential equal to $\frac{1}{2}$ of its maximum differential range. Size of Pipe 4 inches. Air being measured. Pressure 50 lb. absolute.

50 in. Gauge, Full Flow Connections				100 in. Gauge, Flange Connections			
Dia- meter of Orifice Inches	Hourly Orifice Coeffi- cient	Quan- tity cu. ft. per Hour	Fric- tion Loss Inches Water	Dia- meter of Orifice Inches	Hourly Orifice Coeffi- cient	Quan- tity cu. ft. per Hour	Fric- tion Loss Inches Water
$\frac{3}{4}$	121.1	4284	25	$\frac{5}{8}$	81.84	4092	48
$1\frac{1}{2}$	519.9	18390	25	$1\frac{1}{4}$	327.4	16370	44
2	1019.4	36070	25	$1\frac{3}{4}$	642.5	32130	38
$2\frac{5}{8}$	2146.8	76070	22	$2\frac{1}{2}$	1429.8	71500	27
3	3296.2	116620	20	3	2322.7	116100	20

It is noted that a 50 inch gauge at the maximum size of orifice with Full Flow Connections has approximately the same capacity as a 100 inch gauge with Flange Connections. These ratios and percentages are true for the same relative capacities of gauges.

Considerable has been said in regard to the merits of both types of connections relative to friction loss, capacities, etc., but the gist of the facts is as follows. The Flange Connections are more compact; the gauges indicate a higher differential for the same flow through the same orifice; the taps must be located with greater precision. Full Flow (Pipe Tap) Connections are located at points where the pressures are uniform and steady; the range of capacity is 41 per cent greater from minimum to maximum size of orifice for the same pipe; the gauges indicate a lower differential, requiring a smaller maximum range of gauge for the same flow.

Friction loss depends solely on the rates of flow, size of orifice and size of pipe. The larger the orifice the less the friction loss which in turn means a lower differential and a gauge of low maximum range regardless of the type of connections.

PRESSURE LOSS

Whenever an orifice is placed in a line a loss of pressure is created. This loss varies from 40 to 100 per cent of the differential reading (See Page 136) on the chart. For instance, if the differential reading is 54 inches the loss in pressure is not less than 21 inches of water or 0.8 lb. and may amount to 54 inches of water or 2 lb. through the orifice depending on the location of the pressure connections and the size of orifice. As the size of the orifice increases the proportion of pressure loss due to friction compared to differential reading becomes less. For smaller sizes of orifices the lost head is equal or nearly equal to the differential pressure. On a vacuum line this loss creates a less vacuum at the well if the meter is placed between the pump and the well. Each 13.6 inches of water pressure amounts to 1 inch of mercury vacuum. For example, if a vacuum pump pulling 26 inches of vacuum is placed on a line and the normal pressure loss through the line without an orifice is 4 inches of mercury head, the vacuum at the well would be 22 inches. If a

ORIFICE METER MEASUREMENT

small orifice is placed in this line and the differential gauge reading is 54 inches of water (approximately 4 inches of mercury head) then the vacuum existing at the well is only 18 inches. In this case it will be noted that the orifice creates as much friction loss as the pipe line itself.

To overcome this difficulty differential gauges having a maximum reading of 10 and 20 inches have been placed on the market. By using meters of these lower ranges the size of the orifice is increased, thereby decreasing the total differential pressure required to obtain an accurate reading. The proportionate friction loss as compared with the differential reading is likewise decreased.

The use of orifice meters having a differential range of from 60 to 100 inches on vacuum lines should be discouraged on account of the friction losses above stated. Any differential gauge having a range from 0 to 10 inches or greater, will have a capacity sufficient to measure the flow through any vacuum line. The maximum capacity of a 10 inch differential gauge is 32 per cent of the maximum capacity of a 100 inch gauge and 71 per cent of the maximum capacity of the 20 inch gauge. However, the friction loss in measuring the same quantity of gas at the same relative reading on the 10 inch differential gauge chart is less than 10 per cent of the friction loss occasioned by using a 100 inch gauge and less than 50 per cent of that for a 20 inch gauge. For instance, in the previous example with a 10 inch gauge at the same relative chart reading of 5.6 inches the friction loss would be less than 5.6 inches of water pressure or 0.4 inches of mercury head which would leave a vacuum of 21.6 inches at the well with 26 inches at the pump, a line loss of 4 inches mercury head and a meter loss of .4 inches of mercury. Although it is possible to obtain low readings from differential gauges having the higher ranges the same percentage of accuracy in reading cannot be obtained, as when using gauges of lower maximum ranges. For instance, the closest reasonable

reading which could be obtained on a 100 inch chart is about $\frac{1}{2}$ of an inch. The error for a 2 inch differential reading will amount to 12 per cent, whereas, on a 10 inch chart it is easily possible to obtain readings within .05 inch, which would amount to $1\frac{1}{4}$ per cent deviation for a 2 inch differential reading. (See Page 126).

PULSATING FLOW

A great many people believe that when they have a pulsating volume of gas or liquid to be measured, it is only necessary to install "deadeners" or pinch valves on gauge lines to the differential gauge in order to obtain accuracy. This is erroneous. Simply because one kills the pulsation in the lines leading to the high and low pressure side of the differential gauge does not mean that they have stopped the pulsation of the fluid passing through the orifice. It is not practicable to measure pulsating flow by either one orifice meter or a displacement meter. It is as unreasonable as to attempt to weigh a person jumping around on a penny-in-the-slot weighing machine.

The problem which has proven most puzzling has been the measurement of a pulsating flow. This is particularly true where the pulsations are rhythmic, as in the vicinity of compressor stations with reciprocating compressor pistons. The following statement illustrates the varying results obtained in measuring gas where the pulsations were produced by compressors. An orifice meter early installed at such a location failed to check with the station or with meters some 17 miles away on the same line. In endeavoring to locate the difficulty, a series of recording gauges was installed, both with and without devices for "deadening" the pulsations in the lines leading to the gauges. Finally a spring recording gauge, a mercury float gauge of the type originally installed, a differential recording gauge, and a water U tube, were connected in parallel. These gauges were all calibrated in

ORIFICE METER MEASUREMENT

unison, and agreed very well under conditions of steady flow. When the compressor station was started, the gauges took widely varying positions; some dropped down to half their former reading, despite the increased flow, one took a negative reading as though the flow were reversed and the water column took a wholly indeterminate condition of churned foam; some of the gauges moved about in an erratic way and others gave steady indications, but wholly unrelated to the quantity of gas. A proportional meter installed in tandem at this point gave, over a period of months, a record erratic and irreconcilable as compared with pump station displacement, line flow formula, or meters 17 miles away operating on the same gas with steady flow.

Similar disturbances in the accuracy of the record are occasioned by irregular pulsations occasioned by the action of fluid in the line. Disturbances are particularly serious when occasioned by irregular or imperfect action of automatic pressure regulators in the vicinity of the meter. One attempt was made where a device was installed ahead of a compressor station with the idea of dividing the gas into about 20 different streams and making each stream traverse a path of different length so that the wave motion from different parts of the cycle would be made to interfere at the point where the gas was again brought to a common line. This was almost successful, and it is believed that by a little further calculation and change of arrangement to secure more perfect interference a measurement at this point may be secured.

Pulsations due to fluid and imperfect regulators are obviously questions of simple correction, by separators, drips and mechanical repairs.

To obtain accuracy where the gas pulsates badly, one should eliminate the pulsation or move the orifice meter to another location. To eliminate pulsation it is necessary to install drip tanks or more pipe area on the inlet side of the meter.

Compressors are the greatest producers of pulsation. Regulators, and gates near the meter, and water or oil in a gas line will also create pulsation in the line.

Where pulsation is caused by regulators or fittings it is not a difficult matter to move the regulators or fittings far enough back of the meter so as not to cause counter currents, eddies, or pulsations.

Of course, a very slight pulsation may not have any material effect on the accuracy of the orifice meter, but it is best to have none.

Pulsation and Vibration—In order to cover this subject thoroughly a distinction must be made between a vibrating differential pen arm and the pulsating flow which occurs through the orifice.

The differential pen arm will vibrate due to several causes such as; intermittent flow from a well, varying speed of a compressor or pump, non-uniform consumption by a drilling boiler, etc. In these cases the change in the rate of flow is slow enough to permit the differential pen arm to entirely or partially record the changes.

The pulsation which is produced by the rapidly changing rate of flow due to a compressor or pump, is usually so rapid that the differential pen arm indicates a uniform smooth record which may be greatly in error depending entirely upon the character of the wave motion.

Vibration of Differential Pen Arm—In endeavoring to decrease the vibration of the differential pen arm, the use of washers or the method of partially closing valves on the gauge lines, is not satisfactory as any very small leaks between the valves and the gauge will produce an erroneous reading. Washers may become partially stopped up and actually prevent the full pressure at the connection from being exerted on the mercury. Where it is impossible to place large chambers or reservoirs in the main line to eliminate the vibration, the vibration can be reduced most satisfactorily when the dif-

ferential gauges are equipped with small bushings which retard the flow of mercury from the high pressure portion of the gauge to the low pressure portion of the gauge, or vice versa. By using these bushings it is possible to automatically average the peaks and hollows of the differential reading, in cases of wells which flow by heads or where a well is supplying fuel to a drilling boiler or any machine at which the consumption of fuel is intermittent, and thereby reduce the time required in the office to estimate the average reading. Bushings installed in the mercury columns do not increase the accuracy of the gauge and do not decrease it except where the movement of the differential pen arm is greatly retarded requiring more than three minutes to cover the range of the chart. The results obtained from charts where the differential record is averaged in this way will be the same as would be obtained by averaging each 15 minute period by inspection.

Even though the vibration is eliminated, pulsation may exist and the layout should be tested as prescribed in the following article if there is a possibility of error due to rhythmic pulsation through the orifice. It is almost a certainty that the differential reading is erroneous if the static pen arm vibrates rapidly.

Pulsation—As an example of the excessive effect the pulsation due to very rapid uniformly changing rates of flow may have upon results, we show in Fig. 62, layout of the piping in which an orifice meter was installed for measurement of steam. Fig. 63 is a chart obtained while conducting some tests for measurement of steam. It will be noticed in Fig. 62 that the steam header contained two connections to machines using steam, one an air compressor and the other a generator. Some of the steam after passing by these connections was measured by an orifice meter **A** and subsequently weighed as condensate. The flow of steam through the orifice meter **A** was regulated by a valve **C** on the line just prior to conden-

ORIFICE METER MEASUREMENT

sation of the steam. The clock on the differential gauge was altered so that it made a revolution in approximately 96 minutes, therefore, the chart Fig. 63 moved about 15 times as fast as an ordinary 24 hour chart.

Whenever the valve **C** was opened for a certain number of turns and left in that position, it was noticed in all instances that the rate of flow was uniform. On the chart shown in Fig. 63, valve **C** was partially opened during a period when both the generator and compressor were shut down, and if they had remained so the reading would have continued uniform corresponding to a differential of 16 inches. Eight minutes after valve **C** was opened the generator was started and the differential increased from 16 inches to 30 inches without any change in the valve **C**, consequently without any increase whatever in the amount of steam passing through the orifice. After the compressor was started the differential reading again increased without any increase in the amount of steam passing through the orifice. Inasmuch as the increase of differential was not due to an increased flow of steam, the effect was due to the pulsation occasioned by the opening and closing of the slide valves of the generator and compressor, both of them being reciprocating units. It is noted that prior to the test when the machines were not operating that the differential arm remained at zero when there was no steam passing through the orifice, and that after valve **C** was closed, when there was no steam passing through the orifice, that a differential pressure of approximately 9 inches of water was recorded, due to pulsation only. This differential continued as long as the generator and compressor operated at a uniform speed.

The static pen arm in previous tests vibrated over a range of 10 to 15 lb. with a frequency of the opening and closing of the valves of the reciprocating units when they were operating. To lessen this vibration a dash pot was attached to a static pen arm producing the smooth lines as

shown. The effect of partially closing the valves on the gauge lines also produced a smooth pressure reading but gave erratic differential readings. In all cases when the gauge line valves were fully opened the differential reading was very uniform without any appreciable vibration.

The weight of steam passing the orifice checked with a differential reading of 16 inches for the total period of the test, so that the flow corresponded to the reading obtained before the pulsation occurred. The differential due to pulsation caused by the two machines, was 9 inches; and the differential due to pulsation and flow was 49 inches. Assuming the pressure as 85.6 lb., atmospheric pressure 14.4 and Hourly Orifice Coefficient as 10, the rate of flow due to the differential of 16 inches was 400 lb. per hour. ($10\sqrt{100 \times 16} = 400$). The flow corresponding to a 9 inch differential would be 300 lb. per hour ($10\sqrt{100 \times 9} = 300$). For a 49 inch differential the corresponding rate of flow would be 700 lb. per hour. Therefore, the effects due to a pulsation reading of 9 inches increased the flow reading from 16 inches to a combined reading of 49 inches, not simply an addition, but a total reading which was equivalent to the reading which would be obtained by the sum of combined theoretical flows which would have existed for the two independent readings, flow and pulsation ($400 + 300 = 700$). With this layout the effect of the pulsation produced a reading equal to the square of the sum of the square root of the flow differential plus the square root of the pulsation differential. [$49 = (\sqrt{16} + \sqrt{9})^2 = (4 + 3)^2$].

A joint of pipe **MN** was then connected with the main ahead of the orifice. This pipe was closed at the end and an orifice **B** of the same size as the orifice in the main was inserted in the line at the same distance from the junction of the two pipes as orifice **A**. The differential produced by the pulsation at orifice **B** was the same as at the orifice **A** without any flow through the orifices on either line. Furthermore,

ORIFICE METER MEASUREMENT

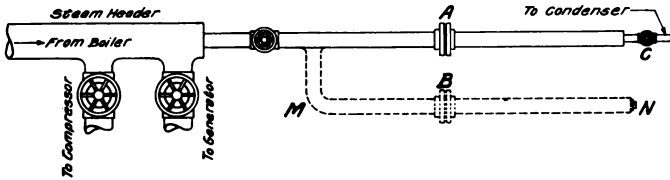

Fig. 62

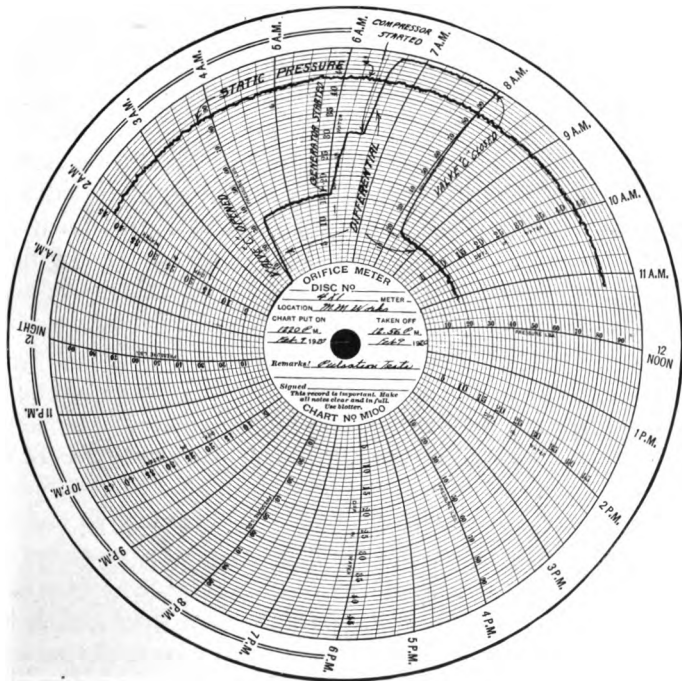

Fig. 63

the flow through the orifice A was equal to the difference of the flows, as would be calculated from the two charts, the steam flowing through the orifice A producing a reading due to flow plus pulsation, and the orifice C on the dead line producing a reading due to pulsation only.

In the layout above described the differential produced by the pulsation only was the same for the same ratio of orifice to size of pipe, i. e., a one-half inch orifice in a two inch pipe produced the same pulsation differential as a one inch orifice in a four inch pipe.

The above remarks are the summarized results of more than sixty tests in which the sizes of pipes, orifices and rates of flow were varied in which the length of straight pipe on each side of the orifice was 16 diameters or greater. The effect of shorter lengths were not determined.

Gauges may be checked to determine if the pulsation has any serious effect on the registration by closing the downstream main valve in a layout similar to Fig. 93, permitting the gas to pass through the by-pass and noting whether the differential chart shows a reading when there is no flow through the orifice. If there is a reading and the valve is in good condition it indicates the flow calculated from the differential reading is in error.

If the differential corresponding to a certain flow is 9 inches and the differential caused by pulsation is $\frac{1}{4}$ inch the differential created by the combined effect may be 12.25 inches $(\sqrt{9} + \sqrt{.25})^2$ or 6.25 inches $(\sqrt{9} - \sqrt{.25})^2$ since the effect of the pulsation may decrease the reading as well as increase it, depending on the layout.

The use of two meters offers a solution for those locations where it is impossible to install reservoirs or to locate the meters so that the effect of the pulsation can be eliminated; one of the gauges being installed on the main, recording the differential produced by the flow and pulsation, and the other

ORIFICE METER MEASUREMENT

meter on a dead line registering the imaginary flow due to pulsation. The difference between the results calculated from these charts being the true flow.

From the above it is seen that bushings will not produce an accurate indication of the flow even though the recorded differential line is a smooth line, when the static pressure varies uniformly and rapidly for the reason that sufficient time may not elapse between the periods of increased pressure or decreased pressure for the differential pen arm to assume a reading corresponding to the average flow. There is only one way to take care of a situation of this kind with one orifice and that is to place a deadener or reservoir in a main gas line large enough to absorb the shocks and cause a steady flow from the deadener or reservoir.

There is no set rule to follow that the writer knows of in regard to when and when not to install a meter where the flow is pulsating. It might be said that in any installation where the static pressure pen arm does not vibrate that the resultant reading obtained may be correct. It is certain that if the static pen arm does vibrate the differential reading will be in error, probably as much as 1000 per cent.

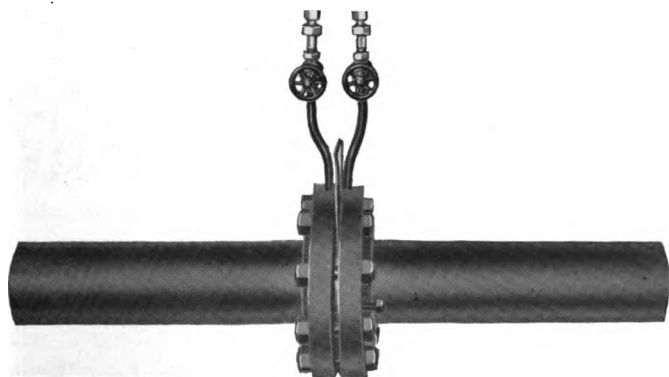

Fig. 64—FLANGE TAP CONNECTIONS

INSTRUCTIONS TO METER ATTENDANTS

One of our most important operations is the measurement of gas, and it is essential that meter charts and records reach the Chart Department in the best possible condition. A little more attention and care on your part can prevent a great many errors that may not be noticed by the one calculating the charts who is not familiar with local operations. You are responsible for the condition of your charts and we wish to call your attention to the following points in order that you may be properly instructed. No doubt you are now observing many of these points, but if they are carried out in the following order, uniform methods will result in better charts.

Changing Orifice Meter Charts—Make a zero differential check and wait a few minutes to see that the pen remains on the zero line, if it does not, report at once or adjust and make note of findings. Release pens from chart by means of pen lifter, remove center nut and slip chart off without touching pens. Wind the clock and put on new chart immediately, seeing that the chart is properly centered and that the differential or red ink pen is on the correct time line. Hold chart in place and *tighten chart nut*. Blot the *removed* chart carefully and fill in complete information: Name of Meter, Location, Disc Number, actual time and date chart was put on and removed. *Always sign your name in full*. Never turn chart by hand to fill in record and make it appear complete when such is not the case. Never allow 24 hour charts to run for more than one day, except in case of absolute necessity, and when this does occur, make notes on chart to identify corresponding lines of each day. **DO NOT SAVE CHARTS UP FOR SEVERAL DAYS, BUT MAIL THEM IN PROMPTLY EACH DAY.** When charts, envelopes or other supplies are needed, make request on face of chart, and give name and address for mailing. *Do not allow your supplies to run out.*

ORIFICE METER MEASUREMENT

When inking pens, use just enough ink to fill the pen, being careful not to confuse the colors. Always use red ink in the long or differential pen. Do not allow excess ink to run down the pen arms or accumulate on the pen lifter where it will smear chart. See that the pens make a good clear line, and that the colors do not get mixed. Pens should be cleaned occasionally to prevent deposits of dried ink and dust.

Before leaving meter, make sure that the pens are touching the chart and marking properly. Also, that the chart is securely clamped and turning with the clock. Waiting a few minutes after the chart is changed and observing these conditions will save a great deal of trouble and bad measurement. See that the gauge is protected from wind and rain, and if you are unable to protect it, call attention to the matter by a note on the chart.

When unusual conditions are indicated by the chart, determine the cause, if possible, and give full information. In case the pens get off the chart, notify the nearest man in charge by telephone, as soon as possible. *Do not allow gauge to remain out of repair WITHOUT CALLING ATTENTION TO IT.*

On all other meters same care should be given to charts. Check readings on index carefully and make subtraction to get last delivery. If no delivery is shown, find the reason and note same on chart.

Any suggestions for improvement that may occur to you will be welcomed in the form of a letter.

Meter Dept.

TESTING APPARATUS

Inspector's Test Pump for Static Pressure Gauges



Fig. 65

Fig. 65 illustrates an inspector's test gauge and pump with carrying case. The use of a test gauge of this kind is recommended for testing Static Pressure Springs rather than the use of a portable dead weight tester. The pressure is applied by filling the pump with oil and forcing the oil into the static spring as well as into the spring of the test gauge.

Vacuum Gauge Test Pump

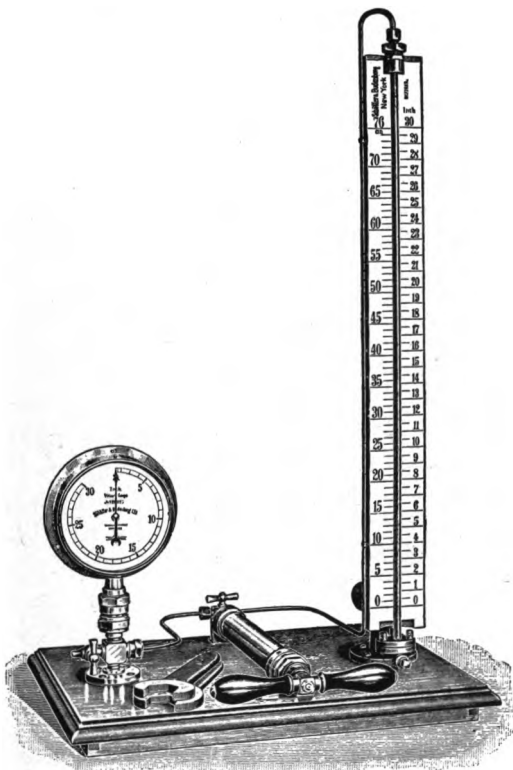

Fig. 66

The pump shown here represents a very efficient apparatus for testing vacuum gauges.

The mercury column is graduated in inches and centimeters. A small set screw is provided on the mercury reservoir for running out the mercury and for accurately adjusting the level of the mercury to the zero point on the scale. This mercury gauge requires about $2\frac{1}{2}$ lb. of mercury.

Pocket Gauge for Testing Differential Gauges



Fig. 67

This siphon or "U" gauge which can be conveniently carried about with the mercury retained is adapted for testing differential gauges. The scale is graduated in inches up to 100 inches of water.

The fittings at the top joining the inlet tube to the glass are made with two swivel joints, permitting the glass and scale to be turned both laterally and vertically. When the gauge is in use the glass is turned away from the inlet tube,

thus opening the gas way at the top, and the outlet cap is loosened. When it is to be placed in the case, the glass is turned in toward the inlet tube, closing the gas way and the outlet cap is screwed down, thus preventing the escape of the mercury at either side.

This apparatus can be used to advantage in locations where it is not advisable to install a permanent gauge for checking differential pressures and where the quantity measured is comparatively small. The short length of columns makes it impractical for use where it is desired to have differential gauge check closer than one-half an inch of water pressure. For accurate determinations or checks it is always necessary to read both columns of the gauge in order to obtain a correct differential.

Siphon or "U" Gauges

For testing gauges whose maximum range is less than 20 inches, the type of gauge shown in Fig. 68 may be used, using water as a fluid.

These are the most convenient low pressure gauges in use, being portable and simply screwed to the piping wherever it is desired to take the pressure.

They consist of a U shaped glass tube with a metal goose-neck, in sizes from 4 inch to 36 inch. Between the columns of this tube is set a scale graduated in inches and tenths, or pounds and ounces, as desired. A bent brass tube, or goose-neck, is connected to the "U" tube at the top and runs down the side to the gas connection.

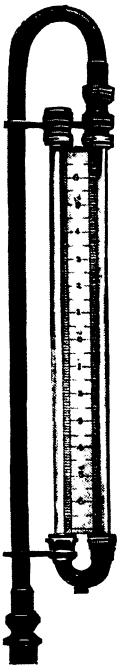

Fig. 68—SIPHON OR "U" GAUGE

When used, the gauge is filled with water or mercury to the center of the scale, which is zero. The gauge is connected to the test tap and the pressure is turned on. The liquid will fall below zero on the inlet side of the "U" tube and rise on the opposite side the same distance. The distance between the two levels of the liquid, as shown by the scale, will indicate the amount of pressure in inches and tenths or in pounds and ounces, according to the graduation.

While the gauge is in use the downward motion of the liquid in one column, due to the pressure of the gas or air should equal the rise of liquid in the opposite column. In case the liquid, after being set at zero, should not drop on the pressure side as much as it rises on the other side, it is an indication that the glass tubes are not of equal diameter, and both columns must be read, their sum being the true pressure.

Permanent Gauge for Testing Differential Gauges

In stations where there are two or more meters which are being used to measure very large quantities of gas and where it is desirable to obtain very accurate measurements, the installation of a permanent test gauge is recommended. The total range of the test gauge being equal to the maximum range of the differential gauges in inches of water. When using a test gauge made of two columns of small bore glass tubing, the gauge should be calibrated between the water levels in the columns or both columns of the gauge must be read, as a very small difference in bore of the tubes will make an appreciable difference in the results if only one column of the U tube is being read and doubled. Furthermore, it is quite possible to obtain inaccurate results due to the water adhering to the surface of the tube on the high pressure side. A reasonable interval of time should be allowed for the water to seek its proper levels before reading.

The difficulties of the U tube consisting of two small bore columns may be obviated by using a U tube in which a high pressure side is made of a chamber of considerable area as compared with the low pressure column. That is, if the area of the high pressure chamber or column is 99 times as great in area as the low pressure column, the water will drop 1 inch on the high side while it rises 99 inches in the low pressure column for a total differential of 100 inches due to the fact that the high pressure chamber is much greater in area than the low pressure column. The rise of 99 inches in the low pressure column may be uniformly divided into 100 parts, then each division of $\frac{99}{100}$ of an inch would represent one inch of water differential. The water in the low pressure column rises $\frac{99}{100}$ of an inch while the water in the high pressure column falls $\frac{1}{100}$ of an inch. If the high pressure column is 1000 times the area of the low pressure column the use of a scale marked in inches would be sufficiently accurate as the total error in 100 inches would be only $\frac{1}{10}$ of an inch

ORIFICE METER MEASUREMENT

in water pressure. Furthermore, in an installation of this kind the water adhering to the sides of either column is so small when compared to the total volume of water that the error in levels would not be appreciable and thus the necessity of waiting for the water to seek its level is eliminated.

Either of the above mentioned gauges may be used for testing under pressure, if the fittings and material are of sufficient strength to withstand the pressure.

Portable Water Differential Test Gauges

Fig. 69 shows portable water gauges constructed on the above principle for testing gauges in the field under working conditions.

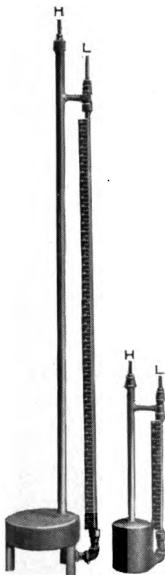

Fig. 69

Courtesy of H. R. Pierce

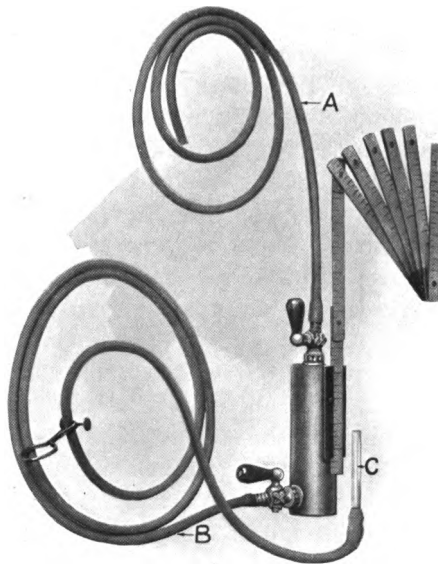

Fig. 70

Courtesy of L. E. Ingham

ORIFICE METER MEASUREMENT

Fig. 70 also shows a small portable outfit which may be used for testing the differential range of gauges. Tube **A** is attached to the high pressure test tap. The small cylinder made of tin or copper is partly filled with water as is also the rubber tubing **B** and the portion of the glass tube **C**. The glass tube **C** is etched or marked and the mark is held at the zero point of the scale attached to the small cylinder. The water is added to the cylinder or through the glass tube **C** until its level reaches the etched mark. When pressure is exerted on the low pressure portion of the gauge, the same pressure acts also on the water in the cylinder causing water to rise on the glass tube **C**. For instance, if it was desired to test the gauge at 10 inches differential, the glass tube **C** is raised until the etched mark is level with the 10 inch mark on the scale. When pressure is exerted on the high pressure side and the differential pen arm rests at the 10 inch mark on the chart the glass tube is moved either up or down until the water surface reaches the etched mark and the check reading is obtained from the scale at a point opposite the mark. It is evident that when the water reaches the etched mark that the surface of the water in the cylinder is at the same point as at the beginning of the test or the zero position, for the combined volume of the water in the cylinder below the zero mark, in the rubber tube **B**, and in the glass tube **C** up to the etched mark is the same as at the beginning of the test. A very small difference may be caused by elasticity of the rubber tubing **B** but since the area of the cylinder is very many times as great as the area of the rubber tubing the effect on the zero position is negligible. When this apparatus is attached to the low pressure side for testing under a vacuum the connection is made with the top of the glass tube **C** instead of being made at the top of the cylinder.

PART FOUR

MEASUREMENT OF GAS AND AIR

AIR AND GAS MEASUREMENT—COEFFICIENTS
—MULTIPLIERS FOR REVISION OF COEFFICIENTS
—OSAGE NATION SPECIFICATIONS—TABLES OF C_v —
ORIFICE CAPACITIES—COMPARATIVE MEASURE-
MENTS—ATMOSPHERIC PRESSURE VARIATIONS—
GAS CONTRACTS—MULTIPLE ORIFICE METER
INSTALLATION—INSTALLING AND TESTING GAS
AND AIR METERS—READING CHARTS.

The Differential and Static Pressure Gauge records on a chart the differential pressure existing between the pressure connections, and the static pressure at one of the connections. These factors, with the known area of the orifice, enable the operator to determine the flow from the formula:

$$Q = C \sqrt{hP}$$

Where Q = the quantity of gas or air passing the orifice.
The result is expressed in cubic feet per hour.

C = the Hourly Orifice Coefficient for gas or air. *The value of this term remains the same for each installation and basis of measurement.*

h = the Differential Pressure existing between the two pressure connections expressed in inches of water head, this value being recorded graphically on the chart of the recording differential gauge.

P = the Static Pressure expressed in absolute units, being equal to the atmospheric pressure (which is recorded on the chart) plus the gauge pressure. The value of the gauge pressure is also recorded on the chart.

The value of the Hourly Orifice Coefficient C in the above formula is found on Pages 173 to 184, computed for various diameters of orifice and diameters of pipe, these values having been determined by exhaustive experimental and practical tests in comparison with actual displacement. The extensions of the values of \sqrt{hP} have been compiled and are given in the book entitled "Pressure Extensions" published by this Company.

Example—One hour reading (Air Flow):

Diam. of Pipe = 4 inches. Diam. of Orifice = 2 inches.

Average Differential reading h = 25 inches.

Base and Flowing Temperature = 60 degrees fahr.

Average Gauge Pressure p = 90 pounds.

Hourly Orifice Coefficient C = 1019.4 for 2 inch orifice in a 4 inch line (Page 173).

Quantity per hour, $Q = 1019.4 \sqrt{25 \times (90 + 14.4)}$

$$\begin{array}{r}
 \text{Orifice Pressure} \\
 = 1019.4 \times 51.088 = 52079 \text{ cu. ft.} \\
 \text{Coefficient. Extension.}
 \end{array}$$

Using the same data, when measuring gas at a 4 oz. Pressure Base, the Hourly Orifice Coefficient C is 1293.7 for a 2 inch orifice in a 4 inch line, (Table 29, Page 175),

$$\begin{array}{r}
 \text{Orifice Pressure} \\
 Q = 1293.7 \sqrt{25 \times (90 + 14.4)} = 1293.7 \times 51.088 \\
 \text{Coefficient. Extension.}
 \end{array}$$

or the volume passing through the orifice = 66093 cubic feet per hour.

Therefore the Quantity per hour flowing in the lines is equal to the Coefficient of the Disc multiplied by the Pressure Extension.

In the formula $V = C_v \sqrt{2gH}$ the differential head or the difference in pressure between the upstream side of the orifice and the downstream side of the orifice is expressed in feet head of flowing fluid and as it is not practical to register this value directly, the differential head is recorded on the chart in inches of water.

Using the same data as used on Page 80 in determination of the value of the air coefficient, the details of the development of the values of the constants for the formula for the flow of air and gases are given below.

1 foot head of air at 32 deg. fahr. (492 degrees absolute) at 14.7 lb. per sq. in. = .015534 inches of water.

Therefore, 1 inch of water = 64.375 feet of air at 32 degrees at 14.7 lb. ($1 \div .015534 = 64.375$).

Since the volume V increases as the pressure decreases, 1 inch of water = 946.31 feet of air at 32 degrees at 1 lb. per sq. in. absolute. ($64.375 \times 14.7 = 946.31$).

Referring to Part 2, we find that the volume decreases as the temperature decreases.

1 inch of water = 1.9234 feet of air at 1 deg. fahr. absolute at 1 lb. per sq. in. absolute. ($946.31 \div 492 = 1.9234$).

For any pressure and temperature:

1 inch of water = $\frac{1.9234 \times T}{P}$ feet of air at T degrees absolute at P lb. absolute, according to the Law of Perfect Gases.

Where T = Temperature in deg. fahr. absolute.

P = Pressure in pounds per square inch absolute.

For gas, as the Specific Gravity G increases the weight per cubic foot increases, and the differential head in feet head of gas decreases, and vice versa.

1 inch of water = $\frac{1.9234T}{PG}$ feet head of gas.

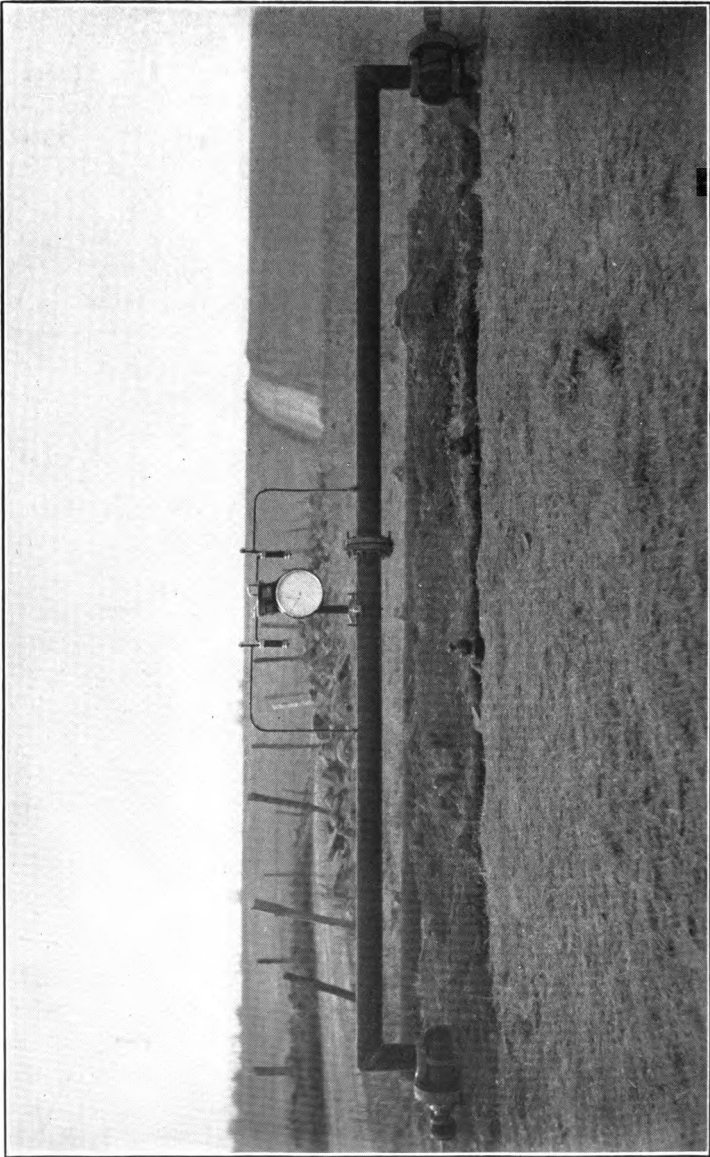

Fig. 71—ORIFICE METER SETTING IN OSAGE NATION See Fig. 98, Page 241.

Then h inches of water = $\frac{1.9234Th}{PG}$ feet head of gas,

But H feet of gas equals h inches of water,

Therefore, $H = \frac{1.9234hT}{PG}$ in feet head of gas,

Where H = differential pressure expressed in feet head of flowing gas.

h = differential in inches of water.

Substituting this value of H in the formula

$V = C_v \sqrt{2gH}$, we obtain

$$V = C_v \sqrt{\frac{2g \times 1.9234hT}{PG}} = 11.13 C_v \sqrt{\frac{hT}{PG}}$$

Where V = actual velocity of gas passing the orifice, at temperature T and pressure P .

C_v = coefficient of velocity.

g = acceleration due to gravity in feet per second, per second, (32.2 used on Page 80).

1.9234 = feet head of air at 1 deg. fahr. absolute at 1 lb. per sq. in. absolute equivalent to one inch of water.

h = differential in inches of water.

T = temperature in deg. fahr. absolute.

P = pressure in pounds per sq. in. absolute.

G = specific gravity of gas (air = 1)

The quantity of gas passing through the orifice is equal to the area of the orifice in square feet multiplied by the velocity in feet per hour

$$Q_1 = \frac{0.7854d^2}{144} \times 3600V$$

$$Q_1 = 19.64d^2 \times V$$

Where Q_1 = actual quantity of gas passing the orifice in cubic feet per hour, at the pressure and temperature of the flowing gas.

$$\frac{0.7854d^2}{144} = \text{area of orifice in sq. ft.}$$

d = diameter of orifice in inches.

144 = number of sq. in. in a sq. ft.

3600 = seconds in one hour.

V = velocity of gas through orifice in feet per sec.

Substituting the value of V where

$$V = 11.13C_v \sqrt{\frac{hT}{PG}}, \text{ in the formula from the preceding page, } Q_1 = 19.64d^2 \times V.$$

$$Q_1 = 19.64d^2 \times 11.13 C_v \sqrt{\frac{hT}{PG}}$$

$$Q_1 = 218.6 C_v \sqrt{\frac{hT}{PG}}$$

Since the gas is measured under standard conditions of Base Temperature and Pressure Base it is really measured by weight by the introduction of these terms.

From the Law of Perfect Gases, Page 59, (in this case Q is substituted for v)

$$\frac{P_b Q}{T_b} = \frac{P Q_1}{T}$$

Where P_b = Pressure Base in pounds per square inch absolute.

P = actual pressure of flowing gas in pounds per square inch absolute.

Q = volume of gas passing orifice expressed in cubic feet at a Pressure Base P_b and a Base Temperature T_b .



Fig. 72.—50 INCH DIFFERENTIAL GAUGE, FLANGE CONNECTIONS

Q_1 = volume in cubic feet passing the orifice at actual Flowing Temperature and Pressure of the gas or air.

T_b = Base Temperature in deg. fahr. absolute.

T = Flowing Temperature in deg. fahr. absolute.

Then $Q = Q_1 \times \frac{PT_b}{P_b T}$

Substituting the value of Q_1 from the previous formula

$$Q_1 = 218.6 C_v d^2 \sqrt{\frac{Th}{PG}} \text{ in this expression.}$$

$$Q = 218.6 C_v d^2 \sqrt{\frac{Th}{PG}} \times \frac{PT_b}{P_b T}$$

with the above

$$Q = 218.6 C_v d^2 \frac{T_b}{P_b} \sqrt{\frac{h P}{T G}}$$

In this formula 218.6 is a constant depending on the units of measurements. On Page 81 the constant for a fifteen minute period is 54.65 being one fourth of 218.6 the constant for one hour.

The net result of these factors is expressed in the formula:

$$Q = K C_v d^2 \frac{T_b}{P_b} \sqrt{\frac{h P}{T G}}$$

Where Q = Quantity of gas passing the orifice expressed in cubic feet at a Base Temperature and a Pressure Base.

K = Constant dependent upon the value of g , weight of water per cubic foot and units of measurement.

C_v = Coefficient of Velocity. The value of this term depends upon the location of the pressure connections in the main line, diameter of orifice, internal diameter of pipe and ratio of differential to line pressure.

d = diameter of orifice in inches.

T_b = Base Temperature in deg. fahr. absolute = 460 +
Base Temperature in degrees fahrenheit on
an ordinary thermometer scale.

P_b = Pressure Base in pounds per square inch absolute.

P = pressure of flowing gas in pounds per square inch
absolute = atmospheric pressure + gauge pres-
sure p . When gas is measured under a vacuum,
 P = atmospheric pressure (in pounds per square
inch) — 0.4908 \times (inches of mercury vacuum).

h = Differential Pressure between the connections
expressed in inches of water.

T = temperature of flowing gas in deg. fahr. absolute
= 460 + temperature in degrees fahrenheit.

G = Specific Gravity of gas compared with air, which
is 1.

The Hourly Coefficient C in Tables 27 to 38

$$= 218.6 C_v d^2 \frac{T_b}{P_b \sqrt{TG}}$$

Thus it is seen that the Coefficient is dependent upon the
values used for K , C_v , d , P_b , T_b , T and G .

Where the conditions of flow are defined, this formula is
simplified as follows:—(Table 27, Page 173).

T_b = 60 deg. fahr. = 520 degrees absolute.

P_b = 0 lb. above atmosphere (14.4 lb.) = 14.4 lb.
per sq. in. absolute.

T = 60 deg. fahr. = 520 deg. absolute.

G = 1.00

$$C = \frac{218.6 C_v d^2 T_b}{P_b \sqrt{TG}} = 218.6 \frac{520 C_v d^2}{14.4 \sqrt{520 \times 1}}$$

$$C = 346.2 C_v d^2.$$

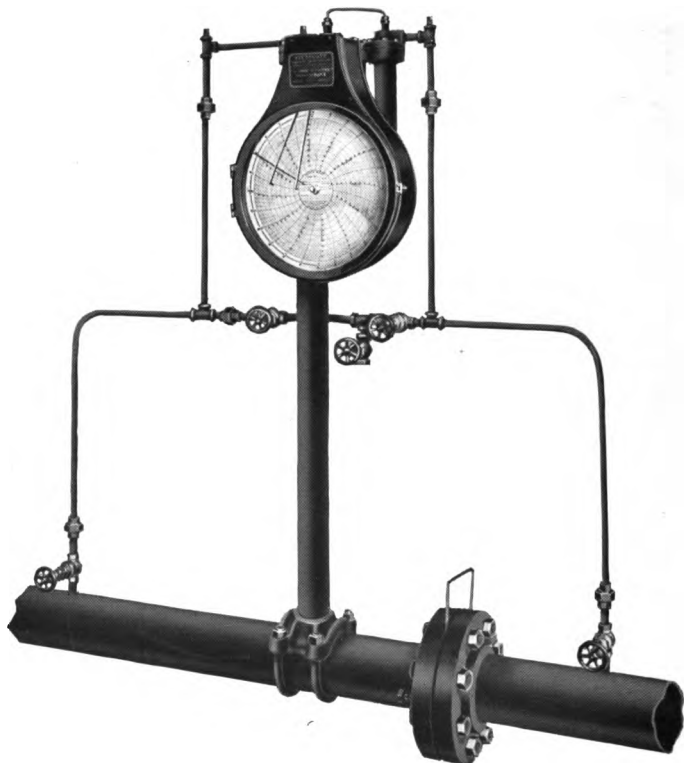

*Fig. 73—ORIFICE, FLANGES AND 100 INCH DIFFERENTIAL GAUGE
INSTALLATION. PIPE TAP CONNECTIONS. NOTE BY-PASS
BETWEEN GAUGE LINES*

The Coefficients in Tables 27 to 38 are prepared for pipe of standard dimensions (4.026, 6.065, 8.071 and 10.191 inches internal diameter), for installations where the pressure connections are made $2\frac{1}{2}$ diameters upstream and 8 diameters downstream. These Hourly Orifice Coefficients were based on the original Hourly Orifice Coefficients (changed for pressure base only). They were calculated from the various values of C_v obtained by inspection from a smooth curve, drawn as a mean through the values of C_v obtained by tests as described in Part 3. The values of C_v were obtained by using the constants used in this article, which constants should be used for calculating orifice coefficients where the conditions do not vary materially from the conditions of the tests.

The values of C_v contained on Pages 208 to 210 were calculated from a formula* which was derived several years later from four points on a curve drawn in a similar manner to the above. These values do not vary more on an average than $\frac{1}{20}$ of one percent from the values of C_v previously mentioned, some of the values being slightly lower and some higher, than those used in the original calculations.

The published values of the air and gas Coefficients are retained in this volume in their original form. Their reliability is not increased by any change except by a series of tests much more comprehensive than those previously conducted. Future tests will no doubt take into consideration the humidity of the atmosphere, and the slight variations due to pressures, differentials, specific gravity, viscosity of the fluid, etc. When such tests are made, it is hoped that they shall be conducted by an authority superior to the operator and the manufacturer and that their findings may be binding upon both the buyer and the seller, such as standard weights and measures are today.

*By H. R. Pierce.

In calculating Hourly Orifice Coefficients for all other dimensions of pipe not contained in the original tables, the use of the values of C_v from Pages 208 to 210 is recommended due to the fact that any two parties will be sure to use the same value, and thus avoid any controversy which may arise over a value obtained by inspection from a plotted curve.

Coefficients for pipes of other internal diameters may be obtained by substituting in the previous formula the proper values for the pressures, temperatures, etc., using the value of 218.6 for K .

Example—Coefficient for a $1\frac{1}{2}$ inch orifice in a pipe 5.188 inches in diameter is desired. Pressure Base 8 oz. above an atmospheric pressure of 14.4 lb. per square inch. Base and Flowing Temperature 60 deg. fahr. Specific Gravity 1.00.

$$P^b = 14.4 + 0.5 = 14.9 \text{ lb. per sq. in. absolute.}$$

$$T^b = 60 + 460 = 520 \text{ deg. fahr. absolute.}$$

$$G = 1.00$$

$$X = \text{diameter of orifice} \div \text{diameter of pipe} = .2891.$$

$$C_v = .6414, \text{ Page 208.}$$

$$C = 218.6 C_v d^2 \frac{T_b}{P_b \sqrt{TG}}$$

$$= \frac{218.6 \times .6414 \times 1.5 \times 1.5 \times 520}{14.9 \sqrt{520 \times 1}} = 482.8$$



Fig. 74—PIPE SADDLE

MEASUREMENT OF GAS AND AIR

Table 27—HOURLY ORIFICE COEFFICIENTS
FOR GAS AND AIR

Pressures taken 2½ diameters upstream and 8 diameters downstream.
Atmospheric Pressure 14.4 lb. Base and Flowing Temperature 60 deg. Fahr.
Pressure Base 0 lb. (14.4 lb. Abs.) Specific Gravity 1.00
Values of C in $Q=C\sqrt{hP}$ where Q=quantity of gas or air passing the orifice
in cubic feet per hour.

DIAMETER OF ORIFICE INCHES	DIAMETER OF PIPE LINE			
	4"	6"	8"	10"
½	53.20	52.88	52.72	52.67
⅝	83.55
¾	121.1	119.6	119.1	118.8
⅞	166.2
1	219.2	214.3	212.7	212.0
1⅛	280.4
1¼	350.6	338.3	334.2	332.5
1⅜	430.1
1½	519.9	493.2	484.6	480.6
1⅝	621.8
1¾	738.2	681.0	665.0	657.5
1⅞	870.2
2	1019.4	904.1	876.4	863.8
2⅛	1189.3
2¼	1382.5	1169.1	1121.8	1100.9
2⅜	1610.8
2½	1856.2	1480.4	1401.2	1368.8
2⅝	2146.8
2¾	2481.9	1851.2	1718.5	1670.0
2⅞	2860.2
3	3296.2	2287.2	2078.8	2004.9
3¼	2806.9	2485.1	2371.9
3½	3428.1	2950.5	2788.3
3¾	4166.8	3474.7	3243.3
4	5050.4	4070.0	3742.9
4¼	6103.8	4752.4	4296.0
4½	7358.2	5519.5	4909.0
4¾	6411.7	5583.7
5	7407.7	6330.8
5¼	8575.8	7164.0
5½	9906.9	8071.2
5¾	11406.5	9098.9
6	13131.1	10225.4
6¼	11481.2
6½	12885.9
6¾	14448.0
7	16196.3
7¼	18125.0
7½	20249.0

MEASUREMENT OF GAS AND AIR

Table 28—HOURLY ORIFICE COEFFICIENTS FOR GAS

Pressures taken $2\frac{1}{2}$ diameters upstream and 8 diameters downstream.
 Atmospheric Pressure 14.4 lb. Base and Flowing Temperature 60 deg. Fahr.
 Pressure Base 0 lb. (14.4 lb. Abs.). Specific Gravity .600
 Values of C in $Q = C \sqrt{hP}$ where Q = quantity of gas passing the orifice in cubic feet per hour.

DIAMETER OF ORIFICE INCHES	DIAMETER OF PIPE LINE			
	4"	6"	8"	10"
$\frac{1}{2}$	68.68	68.27	68.06	68.00
$\frac{5}{8}$	107.90
$\frac{3}{4}$	156.3	154.4	153.8	153.4
$\frac{7}{8}$	214.6
1	282.9	276.7	274.6	273.7
$1\frac{1}{8}$	362.0
$1\frac{1}{4}$	452.6	436.8	431.5	429.2
$1\frac{3}{8}$	555.3
$1\frac{1}{2}$	671.2	636.7	625.6	620.5
$1\frac{5}{8}$	802.8
$1\frac{3}{4}$	953.0	879.1	858.5	848.8
$1\frac{7}{8}$	1123.4
2	1316.1	1167.2	1131.4	1115.2
$2\frac{1}{8}$	1535.4
$2\frac{1}{4}$	1784.8	1509.3	1448.2	1421.2
$2\frac{3}{8}$	2079.5
$2\frac{1}{2}$	2396.3	1911.2	1808.9	1767.2
$2\frac{5}{8}$	2771.5
$2\frac{3}{4}$	3204.1	2390.0	2218.6	2155.9
$2\frac{7}{8}$	3692.5
3	4255.3	2952.7	2683.8	2588.3
$3\frac{1}{4}$	3623.7	3208.3	3062.2
$3\frac{1}{2}$	4425.6	3809.1	3599.7
$3\frac{3}{4}$	5379.3	4485.8	4187.1
4	6520.0	5254.4	4832.0
$4\frac{1}{4}$	7880.0	6135.3	5546.1
$4\frac{1}{2}$	9499.4	7125.7	6337.3
$4\frac{3}{4}$	8277.5	7208.5
5	9563.3	8173.0
$5\frac{1}{4}$	11071.3	9248.6
$5\frac{1}{2}$	12789.7	10419.8
$5\frac{3}{4}$	14725.7	11746.6
6	16952.1	13200.9
$6\frac{1}{4}$	14822.1
$6\frac{1}{2}$	16634.3
$6\frac{3}{4}$	18652.1
7	20909.1
$7\frac{1}{4}$	23399.2
$7\frac{1}{2}$	26141.3

MEASUREMENT OF GAS AND AIR

Table 29—HOURLY ORIFICE COEFFICIENTS FOR GAS

Pressures taken $2\frac{1}{2}$ diameters upstream and 8 diameters downstream.
 Atmospheric Pressure 14.4 lb. Base and Flowing Temp. 60 deg. Fahr.
 Pressure Base 4 oz. (14.65 lb. Abs.) Specific Gravity .600
 Values of C in $Q = C \sqrt{hP}$ where Q = quantity of gas passing the orifice in cubic feet per hour.

DIAMETER OF ORIFICE INCHES	DIAMETER OF PIPE LINE			
	4"	6"	8"	10"
$\frac{1}{2}$	67.5	67.1	66.9	66.8
$\frac{5}{8}$	106.0
$\frac{3}{4}$	153.7	151.8	151.2	150.8
$\frac{7}{8}$	210.9
1	278.1	272.0	269.8	269.1
$1\frac{1}{8}$	355.8
$1\frac{1}{4}$	444.9	429.4	424.1	421.9
$1\frac{3}{8}$	545.9
$1\frac{1}{2}$	659.8	625.9	615.0	609.9
$1\frac{5}{8}$	789.1
$1\frac{3}{4}$	936.8	864.2	844.0	834.4
$1\frac{7}{8}$	1104.3
2	1293.7	1147.4	1112.2	1096.2
$2\frac{1}{8}$	1509.3
$2\frac{1}{4}$	1754.5	1483.7	1423.6	1397.0
$2\frac{3}{8}$	2044.1
$2\frac{1}{2}$	2355.6	1878.7	1778.2	1737.1
$2\frac{5}{8}$	2724.4
$2\frac{3}{4}$	3149.7	2349.4	2180.8	2119.3
$2\frac{7}{8}$	3629.8
3	4183.0	2902.5	2638.2	2544.3
$3\frac{1}{4}$	3562.2	3153.7	3010.1
$3\frac{1}{2}$	4350.4	3744.4	3538.5
$3\frac{3}{4}$	5287.9	4409.6	4116.0
4	6409.2	5165.0	4749.9
$4\frac{1}{4}$	7746.1	6031.0	5451.8
$4\frac{1}{2}$	9337.9	7004.5	6229.6
$4\frac{3}{4}$	8136.8	7084.7
5	9400.8	8034.1
$5\frac{1}{4}$	10883.2	9091.4
$5\frac{1}{2}$	12572.3	10242.7
$5\frac{3}{4}$	14475.4	11547.0
6	16664.0	12976.5
$6\frac{1}{4}$	14570.1
$6\frac{1}{2}$	16350.0
$6\frac{3}{4}$	18335.1
7	20553.8
$7\frac{1}{4}$	23001.5
$7\frac{1}{2}$	25697.0

M E A S U R E M E N T O F G A S A N D A I R

Table 30—HOURLY ORIFICE COEFFICIENTS FOR GAS

Pressures taken $2\frac{1}{2}$ diameters upstream and 8 diameters downstream.
 Atmospheric Pressure 14.4 lb. Base and Flowing Temp. 60 deg. Fahr.
 Pressure Base 8 oz. (14.9 lb. Abs.) Specific Gravity .600
 Values of C in $Q = C \sqrt{hP}$ where Q = quantity of gas passing the orifice in cubic feet per hour.

DIAMETER OF ORIFICE INCHES	DIAMETER OF PIPE LINE			
	4"	6"	8"	10"
$\frac{1}{2}$	66.4	66.0	65.8	65.7
$\frac{5}{8}$	104.2
$\frac{3}{4}$	151.1	149.3	148.3	148.2
$\frac{7}{8}$	207.4
1	273.4	267.4	265.3	264.5
$1\frac{1}{8}$	349.8
$1\frac{1}{4}$	437.4	422.1	417.0	414.8
$1\frac{3}{8}$	536.7
$1\frac{1}{2}$	648.7	615.3	604.6	599.7
$1\frac{5}{8}$	775.8
$1\frac{3}{4}$	921.0	849.6	829.7	820.3
$1\frac{7}{8}$	1085.7
2	1271.9	1128.0	1093.4	1077.7
$2\frac{1}{8}$	1483.9
$2\frac{1}{4}$	1724.9	1458.7	1399.6	1373.5
$2\frac{3}{8}$	2009.7
$2\frac{1}{2}$	2315.9	1847.1	1748.2	1707.9
$2\frac{5}{8}$	2678.5
$2\frac{3}{4}$	3096.6	2309.8	2144.1	2083.5
$2\frac{7}{8}$	3568.6
3	4112.5	2853.6	2593.7	2501.4
$3\frac{1}{4}$	3502.1	3100.6	2959.4
$3\frac{1}{2}$	4277.1	3681.3	3478.9
$3\frac{3}{4}$	5198.8	4335.3	4046.6
4	6301.2	5078.0	4669.9
$4\frac{1}{4}$	7615.6	5929.4	5360.0
$4\frac{1}{2}$	9180.6	6886.5	6124.7
$4\frac{3}{4}$	7999.7	6966.6
5	9242.4	7898.7
$5\frac{1}{4}$	10699.8	8938.3
$5\frac{1}{2}$	12360.5	10070.2
$5\frac{3}{4}$	14231.5	11352.4
6	16383.3	12757.9
$6\frac{1}{4}$	14324.7
$6\frac{1}{2}$	16076.1
$6\frac{3}{4}$	18026.2
7	20207.5
$7\frac{1}{4}$	22613.9
$7\frac{1}{2}$	25264.0

MEASUREMENT OF GAS AND AIR

Table 31—HOURLY ORIFICE COEFFICIENTS FOR GAS

Pressures taken $2\frac{1}{2}$ diameters upstream and 8 diameters downstream.
 Atmospheric Pressure 14.4 lb. Base and Flowing Temp. 60 deg. Fahr.
 Pressure Base 10 oz. (15.025 lb. Abs.) Specific Gravity .600
 Values of C in $Q = C \sqrt{hP}$ where Q = quantity of gas passing the orifice in cubic feet per hour

DIAMETER OF ORIFICE INCHES	DIAMETER OF PIPE LINE			
	4"	6"	8"	10"
$\frac{1}{2}$	65.8	65.4	65.2	65.2
$\frac{5}{8}$	103.4
$\frac{3}{4}$	149.8	148.0	147.4	147.0
$\frac{7}{8}$	205.7
1	271.2	265.2	263.0	262.3
$1\frac{1}{8}$	346.9
$1\frac{1}{4}$	433.7	418.6	413.5	411.4
$1\frac{3}{8}$	532.2
$1\frac{1}{2}$	643.3	610.2	599.6	594.7
$1\frac{5}{8}$	769.4
$1\frac{3}{4}$	913.3	842.5	822.8	813.5
$1\frac{7}{8}$	1076.6
2	1261.3	1118.6	1084.3	1068.7
$2\frac{1}{8}$	1471.6
$2\frac{1}{4}$	1710.6	1446.5	1388.0	1362.1
$2\frac{3}{8}$	1993.0
$2\frac{1}{2}$	2296.6	1831.7	1733.7	1693.7
$2\frac{5}{8}$	2656.2
$2\frac{3}{4}$	3070.9	2290.6	2126.3	2066.2
$2\frac{7}{8}$	3538.9
3	4078.3	2829.9	2572.1	2480.6
$3\frac{1}{4}$	3473.0	3074.8	2934.8
$3\frac{1}{2}$	4241.5	3650.7	3450.0
$3\frac{3}{4}$	5155.5	4299.2	4013.0
4	6248.8	5035.8	4631.0
$4\frac{1}{4}$	7552.2	5880.1	5315.4
$4\frac{1}{2}$	9104.2	6829.2	6073.7
$4\frac{3}{4}$	7933.2	6908.6
5	9165.5	7833.0
$5\frac{1}{4}$	10610.8	8863.9
$5\frac{1}{2}$	12257.7	9986.4
$5\frac{3}{4}$	14113.1	11258.0
6	16247.0	12651.8
$6\frac{1}{4}$	14205.5
$6\frac{1}{2}$	15942.4
$6\frac{3}{4}$	17876.2
7	20039.4
$7\frac{1}{4}$	22425.8
$7\frac{1}{2}$	25053.9

MEASUREMENT OF GAS AND AIR

Table 32—HOURLY ORIFICE COEFFICIENTS FOR GAS

Pressures taken $2\frac{1}{2}$ diameters upstream and 8 diameters downstream.

Atmospheric Pressure 14.4 lb. Base and Flowing Temp 60 deg. Fahr.

Pressure Base 1 lb. (15.4 lb. Abs.) Specific Gravity .600

Values of C in $Q = C\sqrt{hP}$ where Q = quantity of gas passing the orifice in cubic feet per hour.

DIAMETER OF ORIFICE INCHES	DIAMETER OF PIPE LINE			
	4"	6"	8"	10"
$\frac{1}{2}$	64.2	63.8	63.6	63.6
$\frac{5}{8}$	100.9
$\frac{3}{4}$	146.2	144.4	143.8	143.4
$\frac{7}{8}$	200.6
1	264.6	258.7	256.8	256.0
$1\frac{1}{8}$	338.5
$1\frac{1}{4}$	423.2	408.4	403.4	401.4
$1\frac{3}{8}$	519.3
$1\frac{1}{2}$	627.7	595.4	585.0	580.2
$1\frac{5}{8}$	750.6
$1\frac{3}{4}$	891.1	822.0	802.8	793.7
$1\frac{7}{8}$	1050.4
2	1230.6	1091.4	1057.9	1042.7
$2\frac{1}{8}$	1435.7
$2\frac{1}{4}$	1668.9	1411.3	1354.2	1328.9
$2\frac{3}{8}$	1944.5
$2\frac{1}{2}$	2240.7	1787.1	1691.4	1652.4
$2\frac{5}{8}$	2591.6
$2\frac{3}{4}$	2996.1	2234.8	2074.5	2015.9
$2\frac{7}{8}$	3452.8
3	3979.0	2761.0	2509.5	2420.2
$3\frac{1}{4}$	3388.4	2999.9	2863.3
$3\frac{1}{2}$	4138.2	3561.8	3366.0
$3\frac{3}{4}$	5030.0	4194.5	3915.2
4	6096.6	4913.2	4518.3
$4\frac{1}{4}$	7368.3	5736.9	5185.9
$4\frac{1}{2}$	8882.5	6662.9	5925.8
$4\frac{3}{4}$	7740.0	6740.4
5	8942.3	7642.3
$5\frac{1}{4}$	10352.4	8648.1
$5\frac{1}{2}$	11959.2	9743.2
$5\frac{3}{4}$	13769.6	10983.8
6	15851.3	12343.7
$6\frac{1}{4}$	13859.6
$6\frac{1}{2}$	15554.2
$6\frac{3}{4}$	17440.9
7	19551.4
$7\frac{1}{4}$	21879.7
$7\frac{1}{2}$	24443.8

MEASUREMENT OF GAS AND AIR

Table 33—HOURLY ORIFICE COEFFICIENTS FOR GAS

Pressures taken $2\frac{1}{2}$ diameters upstream and 8 diameters downstream.
 Atmospheric Pressure 14.4 lb. Base and Flowing Temperature 60 deg. Fahr.
 Pressure Base $1\frac{1}{2}$ lb. (15.9 lb. Abs.). Specific Gravity .600
 Values of C in $Q = C\sqrt{hP}$ where Q = quantity of gas passing the orifice in cubic feet per hour.

DIAMETER OF ORIFICE INCHES	DIAMETER OF PIPE LINE			
	4"	6"	8"	10"
$\frac{1}{2}$	62.2	61.8	61.6	61.6
$\frac{5}{8}$	97.7
$\frac{3}{4}$	141.6	139.9	139.3	138.9
$\frac{7}{8}$	194.3
1	256.2	250.6	248.7	247.9
$1\frac{1}{8}$	327.8
$1\frac{1}{4}$	409.9	395.6	390.8	388.7
$1\frac{3}{8}$	502.9
$1\frac{1}{2}$	607.9	576.6	566.6	562.0
$1\frac{5}{8}$	727.0
$1\frac{3}{4}$	863.1	796.2	777.6	768.7
$1\frac{7}{8}$	1017.4
2	1191.9	1057.1	1024.7	1009.9
$2\frac{1}{8}$	1390.6
$2\frac{1}{4}$	1616.4	1366.9	1311.6	1287.1
$2\frac{3}{8}$	1883.3
$2\frac{1}{2}$	2170.3	1730.9	1638.2	1600.5
$2\frac{5}{8}$	2510.1
$2\frac{3}{4}$	2901.9	2164.5	2009.3	1952.5
$2\frac{7}{8}$	3344.2
3	3853.9	2674.4	2430.6	2344.1
$3\frac{1}{4}$	3281.9	2905.6	2773.3
$3\frac{1}{2}$	4008.1	3449.8	3260.1
$3\frac{3}{4}$	4871.8	4062.6	3792.1
4	5904.9	4758.7	4376.2
$4\frac{1}{4}$	7136.6	5556.5	5022.9
$4\frac{1}{2}$	8603.2	6453.4	5739.5
$4\frac{3}{4}$	7496.6	6528.4
5	8661.1	7402.0
$5\frac{1}{4}$	10026.9	8376.1
$5\frac{1}{2}$	11583.1	9436.8
$5\frac{3}{4}$	13336.5	10638.4
6	15352.9	11955.5
$6\frac{1}{4}$	13423.8
$6\frac{1}{2}$	15065.0
$6\frac{3}{4}$	16892.5
7	18936.6
$7\frac{1}{4}$	21191.7
$7\frac{1}{2}$	23675.2

MEASUREMENT OF GAS AND AIR

Table 34—HOURLY ORIFICE COEFFICIENTS FOR GAS

Pressures taken $2\frac{1}{2}$ diameters upstream and 8 diameters downstream.
 Atmospheric Pressure 14.4 lb. Base and Flowing Temperature 60 deg. Fahr.
 Pressure Base 2 lb. (16.4 lb. Abs.). Specific Gravity .600
 Values of C in $Q = C \sqrt{hP}$ where Q = quantity of gas passing the orifice in cubic feet per hour.

DIAMETER OF ORIFICE INCHES	DIAMETER OF PIPE LINE			
	4"	6"	8"	10"
$\frac{1}{2}$	60.3	59.9	59.8	59.7
$\frac{5}{8}$	94.7
$\frac{3}{4}$	137.3	135.6	135.1	134.7
$\frac{7}{8}$	188.4
1	248.4	243.0	241.1	240.3
$1\frac{1}{8}$	317.8
$1\frac{1}{4}$	397.4	383.5	378.8	376.9
$1\frac{3}{8}$	487.6
$1\frac{1}{2}$	589.4	559.1	549.3	544.8
$1\frac{5}{8}$	704.9
$1\frac{3}{4}$	836.7	771.9	753.8	745.3
$1\frac{7}{8}$	986.4
2	1155.6	1024.9	993.4	979.1
$2\frac{1}{8}$	1348.2
$2\frac{1}{4}$	1567.1	1325.3	1271.6	1247.9
$2\frac{3}{8}$	1825.9
$2\frac{1}{2}$	2104.1	1678.1	1588.3	1551.7
$2\frac{5}{8}$	2433.5
$2\frac{3}{4}$	2813.4	2098.5	1948.0	1893.0
$2\frac{7}{8}$	3242.2
3	3736.4	2592.6	2356.5	2272.6
$3\frac{1}{4}$	3181.8	2817.0	2688.7
$3\frac{1}{2}$	3885.9	3344.6	3160.7
$3\frac{3}{4}$	4723.3	3938.8	3676.5
4	5724.9	4613.6	4242.8
$4\frac{1}{4}$	6919.0	5387.1	4869.7
$4\frac{1}{2}$	8340.9	6256.7	5564.5
$4\frac{3}{4}$	7268.0	6329.4
5	8397.1	7176.3
$5\frac{1}{4}$	9721.2	8120.7
$5\frac{1}{2}$	11229.9	9149.1
$5\frac{3}{4}$	12929.9	10314.1
6	14884.8	11591.0
$6\frac{1}{4}$	13014.5
$6\frac{1}{2}$	14605.7
$6\frac{3}{4}$	16377.5
7	18359.3
$7\frac{1}{4}$	20545.6
$7\frac{1}{2}$	22953.3

MEASUREMENT OF GAS AND AIR

Table 35—HOURLY ORIFICE COEFFICIENTS FOR GAS AND AIR

Pressures taken $2\frac{1}{2}$ diameters upstream and 8 diameters downstream.
 Atmospheric Pressure 14.7 lb. Base and Flowing Temperature 60 deg. Fahr.
 Pressure Base 0 oz. (14.7 lb. Abs.). Specific Gravity 1.00
 Values of C in $Q = C \sqrt{hP}$ where Q = quantity of gas or air passing the orifice in cubic feet per hour.

DIAMETER OF ORIFICE INCHES	DIAMETER OF PIPE LINE			
	4"	6"	8"	10"
$\frac{1}{2}$	52.11	51.80	51.64	51.60
$\frac{5}{8}$	81.84
$\frac{3}{4}$	118.6	117.2	116.7	116.4
$\frac{7}{8}$	162.8
1	214.7	209.9	208.4	207.7
$1\frac{1}{8}$	274.7
$1\frac{1}{4}$	343.4	331.4	327.4	325.7
$1\frac{3}{8}$	421.3
$1\frac{1}{2}$	509.3	483.1	474.7	470.8
$1\frac{5}{8}$	609.1
$1\frac{3}{4}$	723.1	667.1	651.4	644.1
$1\frac{7}{8}$	852.4
2	998.6	885.6	858.5	846.2
$2\frac{1}{8}$	1165.0
$2\frac{1}{4}$	1354.3	1145.2	1098.9	1078.4
$2\frac{3}{8}$	1577.9
$2\frac{1}{2}$	1818.3	1450.2	1372.6	1340.9
$2\frac{5}{8}$	2103.0
$2\frac{3}{4}$	2431.2	1813.4	1683.4	1635.9
$2\frac{7}{8}$	2801.8
3	3228.9	2240.5	2036.4	1964.0
$3\frac{1}{4}$	2749.6	2434.4	2323.5
$3\frac{1}{2}$	3358.1	2890.3	2731.4
$3\frac{3}{4}$	4081.8	3403.8	3177.1
4	4947.3	3986.9	3666.5
$4\frac{1}{4}$	5979.2	4655.4	4208.3
$4\frac{1}{2}$	7208.0	5406.9	4808.8
$4\frac{3}{4}$	6280.9	5469.7
5	7256.5	6201.6
$5\frac{1}{4}$	8400.8	7017.8
$5\frac{1}{2}$	9704.7	7906.5
$5\frac{3}{4}$	11173.7	8913.2
6	12863.1	10016.7
$6\frac{1}{4}$	11246.9
$6\frac{1}{2}$	12622.9
$6\frac{3}{4}$	14153.1
7	15865.8
$7\frac{1}{4}$	17755.1
$7\frac{1}{2}$	19835.8

MEASUREMENT OF GAS AND AIR

Table 36—HOURLY ORIFICE COEFFICIENTS FOR GAS

Pressures taken $2\frac{1}{2}$ diameters upstream and 8 diameters downstream.
 Atmospheric Pressure 14.7 lb. Base and Flowing Temperature 60 deg. Fahr.
 Pressure Base 4 oz. (14.95 lb. Abs.). Specific Gravity .60
 Values of C in $Q = C \sqrt{h P}$ where Q = quantity of gas passing the orifice
 in cubic feet per hour.

DIAMETER OF ORIFICE INCHES	DIAMETER OF PIPE LINE			
	4"	6"	8"	10"
$\frac{1}{2}$	66.15	65.76	65.56	65.50
$\frac{5}{8}$	103.9
$\frac{3}{4}$	150.6	148.7	148.1	147.7
$\frac{7}{8}$	206.7
1	272.6	266.5	264.5	263.6
$1\frac{1}{8}$	348.7
$1\frac{1}{4}$	436.0	420.7	415.6	413.5
$1\frac{3}{8}$	534.8
$1\frac{1}{2}$	646.5	613.3	602.6	597.6
$1\frac{5}{8}$	773.2
$1\frac{3}{4}$	918.0	846.8	826.9	817.6
$1\frac{7}{8}$	1082.1
2	1267.6	1124.2	1089.8	1074.1
$2\frac{1}{8}$	1478.9
$2\frac{1}{4}$	1719.1	1453.8	1395.0	1369.0
$2\frac{3}{8}$	2003.0
$2\frac{1}{2}$	2308.2	1840.9	1742.4	1702.1
$2\frac{5}{8}$	2669.5
$2\frac{3}{4}$	3086.2	2302.0	2137.0	2076.6
$2\frac{7}{8}$	3556.7
3	4098.8	2844.1	2585.0	2493.1
$3\frac{1}{4}$	3490.4	3090.2	2949.5
$3\frac{1}{2}$	4262.8	3668.9	3467.3
$3\frac{3}{4}$	5181.4	4320.8	4033.0
4	6280.2	5061.0	4654.3
$4\frac{1}{4}$	7590.1	5909.6	5342.1
$4\frac{1}{2}$	9149.9	6863.5	6104.3
$4\frac{3}{4}$	7972.9	6943.3
5	9211.5	7872.3
$5\frac{1}{4}$	10664.0	8908.4
$5\frac{1}{2}$	12319.2	10036.5
$5\frac{3}{4}$	14184.0	11314.5
6	16328.5	12715.3
$6\frac{1}{4}$	14276.9
$6\frac{1}{2}$	16023.6
$6\frac{3}{4}$	17966.1
7	20140.1
$7\frac{1}{4}$	22538.4
$7\frac{1}{2}$	25179.6

MEASUREMENT OF GAS AND AIR

Table 37—HOURLY ORIFICE COEFFICIENTS FOR GAS

Pressures taken $2\frac{1}{2}$ diameters upstream and 8 diameters downstream.
 Atmospheric Pressure 14.7 lb. Base and Flowing Temperature 60 deg fahr.
 Pressure Base 8 oz. (15.2 lb. Abs.). Specific Gravity .60
 Values of C in $Q = C \sqrt{hP}$ where Q = quantity of gas passing the orifice
 in cubic feet per hour.

DIAMETER OF ORIFICE INCHES	DIAMETER OF PIPE LINE			
	4"	6"	8"	10"
$\frac{1}{2}$	65.07	64.67	64.48	64.42
$\frac{5}{8}$	102.2
$\frac{3}{4}$	148.1	146.3	145.7	145.3
$\frac{7}{8}$	203.3
1	268.1	262.1	260.1	259.3
$1\frac{1}{8}$	342.9
$1\frac{1}{4}$	428.8	413.8	408.7	406.7
$1\frac{3}{8}$	526.0
$1\frac{1}{2}$	635.9	603.2	592.7	587.8
$1\frac{5}{8}$	760.5
$1\frac{3}{4}$	920.9	832.9	813.3	804.2
$1\frac{7}{8}$	1064.3
2	1246.8	1105.8	1071.9	1056.5
$2\frac{1}{8}$	1454.6
$2\frac{1}{4}$	1690.9	1429.9	1372.0	1346.5
$2\frac{3}{8}$	1970.1
$2\frac{1}{2}$	2270.2	1810.6	1713.7	1674.1
$2\frac{5}{8}$	2625.6
$2\frac{3}{4}$	3035.5	2264.1	2101.8	2042.5
$2\frac{7}{8}$	3498.2
3	4031.4	2797.4	2542.5	2452.1
$3\frac{1}{4}$	3433.0	3039.4	2900.9
$3\frac{1}{2}$	4192.7	3608.6	3410.2
$3\frac{3}{4}$	5096.2	4249.7	3966.7
4	6176.9	4977.8	4577.7
$4\frac{1}{4}$	7465.2	5812.4	5254.2
$4\frac{1}{2}$	8999.4	6750.6	6003.9
$4\frac{3}{4}$	7841.8	6829.1
5	9060.0	7742.9
$5\frac{1}{4}$	10488.6	8761.9
$5\frac{1}{2}$	12116.6	9871.5
$5\frac{3}{4}$	13950.7	11128.4
6	16060.0	12506.1
$6\frac{1}{4}$	14042.0
$6\frac{1}{2}$	15760.1
$6\frac{3}{4}$	17670.6
7	19808.8
$7\frac{1}{4}$	22167.7
$7\frac{1}{2}$	24765.5

MEASUREMENT OF GAS AND AIR

Table 38—HOURLY ORIFICE COEFFICIENTS FOR GAS

Pressures taken $2\frac{1}{2}$ diameters upstream and 8 diameters downstream.
 Atmospheric Pressure 14.7 lb. Base and Flowing Temperature 60 deg. Fahr.
 Pressure Base 10 oz. (15.325 lb. Abs.). Specific Gravity .60
 Values of C in $Q = C \sqrt{hP}$ where Q = quantity of gas passing the orifice
 in cubic feet per hour.

DIAMETER OF ORIFICE INCHES	DIAMETER OF PIPE LINE			
	4"	6"	8"	10"
$\frac{1}{2}$	64.54	64.15	63.95	63.89
$\frac{5}{8}$	101.4
$\frac{3}{4}$	146.9	145.1	144.5	144.1
$\frac{7}{8}$	201.6
1	265.9	260.0	258.0	257.2
$1\frac{1}{8}$	340.1
$1\frac{1}{4}$	425.3	410.4	405.4	403.3
$1\frac{3}{8}$	521.7
$1\frac{1}{2}$	630.7	598.3	587.9	583.0
$1\frac{5}{8}$	754.3
$1\frac{3}{4}$	895.5	826.1	806.7	797.6
$1\frac{7}{8}$	1055.6
2	1236.6	1096.7	1063.1	1047.9
$2\frac{1}{8}$	1442.7
$2\frac{1}{4}$	1677.1	1418.2	1360.8	1335.5
$2\frac{3}{8}$	1954.0
$2\frac{1}{2}$	2251.7	1795.8	1699.8	1660.5
$2\frac{5}{8}$	2604.2
$2\frac{3}{4}$	3010.7	2245.6	2084.7	2025.8
$2\frac{7}{8}$	3469.6
3	3998.5	2774.5	2521.7	2432.1
$3\frac{1}{4}$	3405.0	3014.6	2877.3
$3\frac{1}{2}$	4158.5	3579.2	3382.4
$3\frac{3}{4}$	5054.6	4215.1	3934.4
4	6126.5	4937.2	4540.4
$4\frac{1}{4}$	7404.3	5765.0	5211.4
$4\frac{1}{2}$	8926.0	6695.5	5955.0
$4\frac{3}{4}$	7777.8	6773.4
5	8986.1	7679.7
$5\frac{1}{4}$	10403.1	8690.4
$5\frac{1}{2}$	12017.8	9790.9
$5\frac{3}{4}$	13836.9	11037.6
6	15929.0	12404.1
$6\frac{1}{4}$	13927.5
$6\frac{1}{2}$	15631.5
$6\frac{3}{4}$	17526.4
7	19647.3
$7\frac{1}{4}$	21986.9
$7\frac{1}{2}$	24563.5

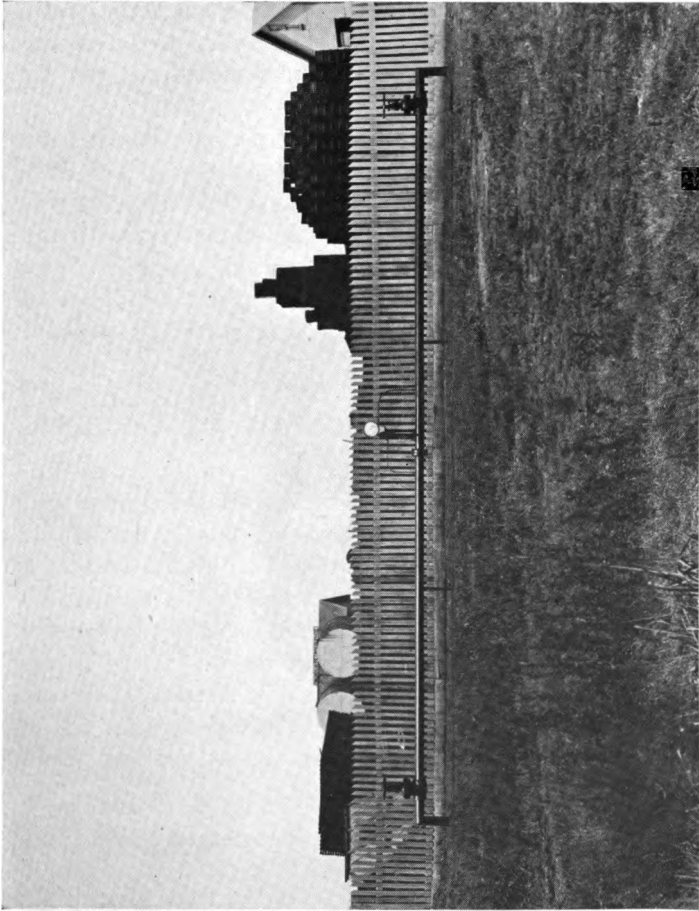

Fig. 75—ONE OF THE FIRST ORIFICE METER INSTALLATIONS. PIPE TAP CONNECTIONS.

SPECIFIC GRAVITY

Specific gravity is the ratio between the density of a body and the density of some body chosen as a standard. In stating the specific gravities of gases, air is generally taken as a standard. It is very necessary to know the specific gravity of a gas when one is measuring gas by an orifice meter.

The most accurate instrument for use in obtaining the specific gravity, is the specific gravity balance. The effusion method cannot be relied upon for accurate determinations unless tests have been made in comparison with the specific gravity balance with various specific gravities of gas. A complete description of the methods and a full set of effusion method tables are contained in our Hand Book of Casinghead Gas.

MULTIPLIERS FOR REVISION OF COEFFICIENTS

It was noted that each Table of Hourly Orifice Coefficients was calculated upon certain values for Base and Flowing Temperature, Gravity, Pressure Base, Atmospheric Pressure and location of connections. It would require a library of unlimited size to present coefficients to meet all conditions of flow measurement which an orifice meter will satisfactorily handle. In this volume we present the Tables of Hourly Orifice Coefficients which will meet the most frequent requirements and Tables of Multipliers for use in converting the coefficients to meet almost any condition.

Let C_n = new Coefficient desired.

T_{bn} = proposed new Base Temperature in degrees fahrenheit absolute.

P_{bn} = proposed new Pressure Base in pounds per square inch absolute.

T_n = new or actual Flowing Temperature of gas in degrees fahrenheit absolute.

G_n = new or actual Specific Gravity of gas being measured.

$$C_n = 218.6 C_v d^2 \frac{T_{bn}}{P_{bn} \sqrt{T_n G_n}}$$

$$\frac{C_n}{C} = \frac{218.6 C_v d^2 T_{bn} P_b \sqrt{TG}}{218.6 C_v d^2 T_b P_{bn} \sqrt{T_n G_n}}$$

$$C_n = C \times \frac{T_{bn} P_b \sqrt{TG}}{T_b P_{bn} \sqrt{T_n G_n}}$$

Therefore, the Multiplier = $\frac{T_{bn} P_b \sqrt{TG}}{T_b P_{bn} \sqrt{T_n G_n}}$

Example—Diameter of pipe, 6 inches. Diameter of orifice, 3 inches.

Pressure taken $2\frac{1}{2}$ diameters upstream and 8 diameters downstream.

Proposed new Base Temperature, 50 deg. fahr. ($T_{bn} = 510$ deg. absolute).

Proposed new Pressure Base, $1\frac{1}{2}$ lb. above an average atmosphere pressure of 14.4 lb. ($P_{bn} = 15.9$ lb. absolute).

New or actual Flowing Temperature, 50 deg. fahr. ($T_n = 510$ deg. absolute).

New or actual Specific Gravity, $G_n = 0.65$

In Table 29 the Coefficient 2902.5 is based upon a Base Temperature T_b and Flowing Temperature T of 60 deg. fahr. (520 deg. absolute), Pressure Base 4 ounces ($P_b = 14.65$ lb. absolute), and Specific Gravity $G = 0.600$

Substituting these values in the above formula.

$$\text{Multiplier} = \frac{510 \times 14.65}{520 \times 15.9} \sqrt{\frac{520 \times 0.60}{510 \times 0.65}} = 0.87679$$

MEASUREMENT OF GAS AND AIR

New Coefficient $C_n = 2902.5 \times .87679 = 2544.9$
 or using the Multiplier Tables 39, 42, 43 and 45.

	Multiplying Factor
Table 42, 50 deg. Base Temperature	= .9808
Table 39, $1\frac{1}{2}$ lb. Pressure Base (Coefficient in Table based on 4 oz.)	= .9214
Table 43, 50 deg. Flowing Temperature	= 1.0098
Table 45, Specific Gravity .65 (Coefficient in Table based on .600)	= .9608

The New Coefficient

$$C_n = 2902.5 \times .9808 \times .9214 \times 1.0098 \times .9608 = 2544.9$$

Multiplier for Change of Pressure Base—

$$C_n = C \frac{P_b}{P_{bn}}, \text{ in which } \frac{P_b}{P_{bn}} \text{ is the multiplier.}$$

C_n = new or revised Coefficient.

C = Coefficient determined upon Pressure Base P_b .

P_b = Pressure Base in pounds per square inch absolute upon which coefficient C was calculated.

P_{bn} = new or proposed Pressure Base in lb. per square inch absolute.

Example—Pressures taken $2\frac{1}{2}$ diameters upstream and 8 diameters downstream.

Pipe Diameter = 4 inches. Base and Flowing Temperature = 60 deg. fahr.

Orifice Diameter = 2 inches. Atmospheric Pressure = 14.4 lb.

Pressure Base = 8 ounces. Specific Gravity = .600.

The Coefficient 1293.7 in Table 29 fulfills all conditions with the exception of Pressure Base (4 oz.) upon which the table was prepared.

In Table 39 the Multiplying Factor for 8 oz. Pressure Base = .9832 (for converting Coefficient from 4 oz. Pressure Base, 14.65 lb. absolute, to an 8 oz. Pressure Base) which is

equal to
$$\frac{14.4+0.25}{14.4+0.50} = \frac{14.65}{14.9}$$

$$C_n = 1293.7 \text{ (Orifice Coefficient from Table 29)} \times .9832 = 1271.9$$

In case that the atmospheric pressure is different from 14.4 and if a different value is specified in the contract, see following subject.

Multiplier for Atmospheric Pressure Changes—

$$C_n = C \frac{A + p_b}{A_n + p_b}, \text{ in which } \frac{A + p_b}{A_n + p_b} \text{ is the multiplier.}$$

C_n = new or revised Coefficient.

C = Coefficient based upon an atmospheric pressure A .

A = Atmospheric Pressure in pounds per square inch upon which the Orifice Coefficient C was calculated. The value used in Tables in this book is 14.4 or 14.7 pounds per square inch.

p_b = Pressure Base (pressure expressed in pounds per square inch above atmosphere).

A_n = actual or new Atmospheric Pressure in lb. per square inch which equals ordinary Barometer reading in inches of mercury times 0.4908.

Example—Pressures taken $2\frac{1}{2}$ diameters upstream and 8 diameters downstream.

MEASUREMENT OF GAS AND AIR

Pipe Diameter = 4 inches. Base Temperature = 60 deg. fahr.

Orifice Diameter = 1 inch. Flowing Temperature = 60 deg. fahr.

Pressure Base = 4 oz. above atmospheric pressure. Atmospheric Pressure = 12.0 lb.

Specific Gravity = .600.

Therefore, the proposed Pressure Base is $12.0 + 0.25$ (4 oz.) = 12.25 lb. (absolute).

The Coefficient 278.1 in Table 29 fulfills all conditions with the exception of the Atmospheric Pressure (14.4 lb.) upon which the Table was calculated.

In Table 41 the Multiplying Factor is 1.1959 for converting the Coefficient from 14.4 lb. to 12 lb. Atmospheric Pressure at 4 oz. Pressure Base.

$$\text{This factor } 1.1959 = \frac{14.4 + 0.25}{12.0 + 0.25} = \frac{14.65}{12.25}$$

$$C_n = 278.1 \text{ (Orifice Coefficient from Table 29)} \times 1.1959 = 332.6.$$

See note at foot of Page 196, also Page 221.

In cases where the Pressure Base also changes or is different from that of the Table,

$$\text{The multiplier is } \frac{A + p_b}{A_n + p_{bn}}$$

Where p_{bn} is the new Pressure Base expressed in pounds per square inch above the atmospheric pressure.

Multiplier for Base Temperature Changes—

$$C_n = C \frac{T_{bn}}{T_b}, \text{ in which } \frac{T_{bn}}{T_b} \text{ is the multiplier.}$$

C_n = new or revised Coefficient.

C = Coefficient based upon Base Temperature T_b .

T_{bn} = new or revised Base Temperature in degrees fahrenheit absolute.

T_b = Base Temperature upon which Coefficient C was calculated. Tables are usually prepared for 60 deg. fahr. (520 deg. absolute)

Example—Pressures taken 2½ diameters upstream and 8 diameters downstream.

Pipe Diameter = 8 inches. Base Temperature = 80 deg. fahr.

Orifice Diameter = 4 inches. Flowing Temperature = 60 deg. fahr.

Pressure Base = 4 ounces. Atmospheric Pressure = 14.4 lb.

Specific Gravity = .600.

The Coefficient 5165 in Table 29 fulfills all conditions with the exception of the Base Temperature (60 deg. fahr.) upon which the Table was calculated.

In Table 42 the multiplying factor is 1.0385.

$$\text{This factor} = \frac{460+80}{460+60} = \frac{540}{520}$$

$$C_n = 5165 \text{ (Orifice Coefficient from Table 29)} \times 1.0385 = 5363.9$$

Multiplier for Changes in Flowing Temperature—

$$C_n = C \sqrt{\frac{T}{T_n}} \text{ in which } \sqrt{\frac{T}{T_n}} \text{ is the multiplier.}$$

C_n = new or revised Coefficient.

C = Coefficient calculated upon the Flowing Temperature T .

T = Flowing Temperature in degrees fahrenheit absolute upon which the Coefficient C was calculated. Tables are usually prepared using a Flowing Temperature of 60 deg. fahr. (520 deg. absolute).

T_n = actual or new Flowing Temperature.

Example—Pressures taken $2\frac{1}{2}$ diameters upstream and 8 diameters downstream.

Pipe Diameter = 6 inches. Base Temperature = 60 deg. fahr.

Orifice Diameter = 4 inches. Flowing Temperature = 90 deg. fahr.

Pressure Base = 0 pounds. Atmospheric Pressure = 14.4 lb.

Specific Gravity = 1.00

The Coefficient 5050.4 in Table 27 fulfills all conditions with the exception of the Flowing Temperature which is 60 deg. fahr. In Table 43 the multiplying factor is .9723 for converting Coefficient from 60 deg. to 90 deg. fahr. Flowing Temperature.

$$\text{This factor} = \sqrt{\frac{460+60}{460+90}} = \sqrt{\frac{520}{550}}$$

$$C_n = 5050.4 \text{ (Orifice Coefficient, Table 27)} \times .9723 = 4910.5.$$

Multiplier for Specific Gravity Changes—

$$C_n = C \sqrt{\frac{G}{G_n}} \text{ in which } \sqrt{\frac{G}{G_n}} \text{ is the multiplier.}$$

C_n = new or revised Coefficient.

C = Coefficient based upon Specific Gravity G .

G = Specific Gravity upon which the Coefficient C was calculated. The Tables on Pages 199 and 200 were prepared for revision of Coefficients based on a Specific Gravity of 1.000 or .600.

G_n = actual or new Specific Gravity.

Example—Pressures taken $2\frac{1}{2}$ diameters upstream and 8 diameters downstream.

Pipe Diameter = 10 inches. Base Temperature = 60 deg. fahr.

Orifice Diameter = 4 inches. Flowing Temperature = 60 deg. fahr.

Pressure Base = 0 pounds. Atmospheric Pressure = 14.4 lb.

Specific Gravity = 1.20

The Coefficient 3742.9 in Table 27 fulfills all conditions with the exception of the Specific Gravity which is 1.00. In Table 44 the multiplying factor is .9129 for converting the Coefficient from 1.00 to 1.20 Specific Gravity:

$$\text{This factor} = \sqrt{\frac{1.00}{1.20}}$$

$$C_n = 3742.9 \text{ (Hourly Orifice Coefficient from Table 27)} \times .9129 = 3416.9.$$

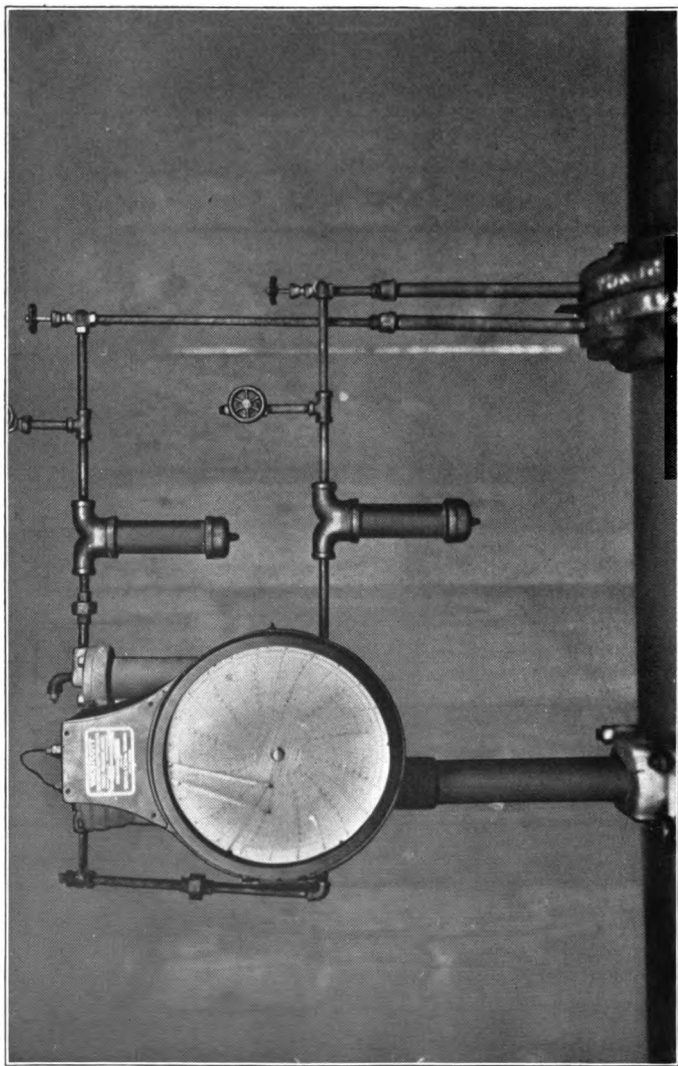

Fig. 76—ORIFICE METER INSTALLATION. FLANGE CONNECTIONS.

Table 39
PRESSURE BASE MULTIPLIERS

Atmospheric Pressure 14.4 lb.

New Pressure Base	Table—0 lb. 14.4 lb. Abs.	Table—4 oz. 14.65 lb. Abs.
0 oz.	1.0000	1.0173
4 oz.	.9829	1.0000
8 oz.	.9664	.9832
10 oz.	.9584	.9750
1 lb.	.9351	.9513
1½ lb.	.9057	.9214
2 lb.	.8780	.8933
3 lb.	.8276	.8420

Table 40
PRESSURE BASE MULTIPLIERS

Atmospheric Pressure 14.7 lb.

New Pressure Base	Table—0 lb. 14.7 lb. Abs.	Table—4 oz. 14.95 lb. Abs.
0 oz.	1.0000	1.0170
4 oz.	.9833	1.0000
8 oz.	.9671	.9836
10 oz.	.9592	.9755
1 lb.	.9363	.9522
2 lb.	.8802	.8952
3 lb.	.8305	.8446

When the new Pressure Base is other than 0 pounds or 4 oz. multiply the Coefficient by the proper Multiplier in these tables to revise the Coefficient for the new Pressure Base provided the original Coefficient was calculated from one of these Bases. Otherwise use formula on Page 189.

MEASUREMENT OF GAS AND AIR

Table 41
MULTIPLIERS FOR ATMOSPHERIC
PRESSURE CHANGES

This Table is calculated for revision of Coefficients based on Atmospheric Pressure 14.4 lb., plus a certain Pressure Base to another Atmospheric Pressure plus the same Pressure Base. If the gas is to be calculated at a Base above 14.4 regardless of the Atmospheric Pressure, do not use this Table. See Page 221.

Atmospheric Pressure Pounds.	PRESSURE BASE							
	0 oz.	4 oz.	8 oz.	10 oz.	1 lb.	1½ lb.	2 lb.	3 lb.
11.8	1.2203	1.2158	1.2114	1.2093	1.2031	1.1955	1.1884	1.1757
12.0	1.2000	1.1959	1.1920	1.1901	1.1846	1.1778	1.1714	1.1600
12.2	1.1803	1.1767	1.1732	1.1715	1.1667	1.1606	1.1549	1.1447
12.4	1.1613	1.1581	1.1550	1.1536	1.1493	1.1439	1.1389	1.1299
12.6	1.1429	1.1401	1.1374	1.1361	1.1324	1.1277	1.1233	1.1154
12.8	1.1250	1.1226	1.1203	1.1192	1.1159	1.1119	1.1081	1.1013
13.0	1.1077	1.1057	1.1037	1.1027	1.1000	1.0966	1.0933	1.0875
13.2	1.0909	1.0892	1.0876	1.0868	1.0845	1.0816	1.0789	1.0741
13.4	1.0746	1.0733	1.0719	1.0713	1.0694	1.0671	1.0649	1.0610
13.6	1.0588	1.0578	1.0567	1.0562	1.0548	1.0530	1.0513	1.0482
13.8	1.0435	1.0428	1.0420	1.0416	1.0405	1.0392	1.0380	1.0357
14.0	1.0286	1.0281	1.0276	1.0274	1.0267	1.0258	1.0250	1.0235
14.2	1.0141	1.0139	1.0137	1.0134	1.0132	1.0127	1.0123	1.0116
14.4	1.0000	1.0000	1.0000	1.0000	1.0000	1.0000	1.0000	1.0000
14.6	.9863	.9865	.9868	.9869	.9872	.9876	.9880	.9886
14.7	.9796	.9799	.9803	.9804	.9809	.9815	.9820	.9831
14.8	.9730	.9734	.9739	.9741	.9747	.9755	.9762	.9775

These factors apply to Atmospheric Pressure changes only. If the Atmospheric Pressure and the Pressure Base both change, make the correction first for Pressure Base and then for Atmospheric Pressure. To use the Table of Pressure Extensions set the static pen arm for Atmospheric Pressure reading above or below the zero line of chart by the number of pounds the Atmospheric Pressure is above or below 14.4 lb. per sq. in. or 29.3 inches of mercury. If Atmospheric Pressure is 27.3 inches of mercury or approximately 13.4 lb. set the static pen arm to read one lb. below zero reading when the gauge lines are open. The Atmospheric Pressure is expressed in pounds per square inch. See Pages 189 and 221.

Table 42

BASE TEMPERATURE MULTIPLIERS

Where the Base Temperature upon which the Coefficients were
calculated was 60 deg. fahr.

Degrees Fahr.	Multi- plier	Degrees Fahr.	Multi- plier	Degrees Fahr.	Multi- plier
41	.9635	61	1.0019	81	1.0404
42	.9654	62	1.0038	82	1.0423
43	.9673	63	1.0058	83	1.0442
44	.9692	64	1.0077	84	1.0462
45	.9712	65	1.0096	85	1.0481
46	.9731	66	1.0115	86	1.0500
47	.9750	67	1.0135	87	1.0519
48	.9769	68	1.0154	88	1.0538
49	.9788	69	1.0173	89	1.0558
50	.9808	70	1.0192	90	1.0577
51	.9827	71	1.0212	91	1.0596
52	.9846	72	1.0231	92	1.0615
53	.9865	73	1.0250	93	1.0635
54	.9885	74	1.0269	94	1.0654
55	.9904	75	1.0288	95	1.0673
56	.9923	76	1.0308	96	1.0692
57	.9942	77	1.0327	97	1.0712
58	.9962	78	1.0346	98	1.0731
59	.9981	79	1.0365	99	1.0750
60	1.0000	80	1.0385	100	1.0769

When the Base Temperature is greater or less than 60 deg., multiply the Coefficient or the result by the Multiplier opposite the Base Temperature in the above Table. See Page 191.

MEASUREMENT OF GAS AND AIR

Table 43

FLOWING TEMPERATURE MULTIPLIERS

Where the Flowing Temperature upon which the Coefficients were
calculated was 60 deg. fahr.

Degrees Fahr.	Multiplier	Degrees Fahr.	Multiplier	Degrees Fahr.	Multiplier
		33	1.0270	67	.9933
0	1.0632	34	1.0260	68	.9924
1	1.0621	35	1.0249	69	.9915
2	1.0609	36	1.0239	70	.9905
3	1.0598	37	1.0229	71	.9896
4	1.0586	38	1.0219	72	.9887
5	1.0575	39	1.0208	73	.9877
6	1.0564	40	1.0198	74	.9868
7	1.0552	41	1.0188	75	.9859
8	1.0541	42	1.0178	76	.9850
9	1.0530	43	1.0167	77	.9841
10	1.0518	44	1.0157	78	.9831
11	1.0507	45	1.0147	79	.9822
12	1.0496	46	1.0137	80	.9813
13	1.0485	47	1.0127	81	.9804
14	1.0474	48	1.0117	82	.9795
15	1.0463	49	1.0107	83	.9786
16	1.0452	50	1.0098	84	.9777
17	1.0441	51	1.0088	85	.9768
18	1.0430	52	1.0078	86	.9759
19	1.0419	53	1.0068	87	.9750
20	1.0408	54	1.0058	88	.9741
21	1.0398	55	1.0048	89	.9732
22	1.0387	56	1.0039	90	.9723
23	1.0376	57	1.0029	91	.9715
24	1.0365	58	1.0019	92	.9706
25	1.0355	59	1.0010	93	.9697
26	1.0344	60	1.0000	94	.9688
27	1.0333	61	.9990	95	.9680
28	1.0323	62	.9981	96	.9671
29	1.0312	63	.9971	97	.9662
30	1.0302	64	.9962	98	.9653
31	1.0291	65	.9952	99	.9645
32	1.0281	66	.9943	100	.9636

When the Flowing Temperature is greater or less than 60 deg., multiply the Coefficient or the result by the Multiplier opposite the Flowing Temperature in the above Table. See Page 192.

Table 44
SPECIFIC GRAVITY MULTIPLIERS

Where the Specific Gravity upon which the Coefficients were
calculated was 1.00

Specific Gravity	Multi-plier	Specific Gravity	Multi-plier	Specific Gravity	Multi-plier
.56	1.3363	.91	1.0483	1.26	.8909
.57	1.3245	.92	1.0426	1.27	.8874
.58	1.3131	.93	1.0370	1.28	.8839
.59	1.3019	.94	1.0314	1.29	.8805
.60	1.2910	.95	1.0260	1.30	.8771
.61	1.2804	.96	1.0206	1.31	.8737
.62	1.2700	.97	1.0153	1.32	.8704
.63	1.2599	.98	1.0102	1.33	.8671
.64	1.2500	.99	1.0050	1.34	.8639
.65	1.2403	1.00	1.0000	1.35	.8607
.66	1.2309	1.01	.9950	1.36	.8575
.67	1.2217	1.02	.9901	1.37	.8544
.68	1.2127	1.03	.9853	1.38	.8513
.69	1.2039	1.04	.9806	1.39	.8482
.70	1.1952	1.05	.9759	1.40	.8452
.71	1.1868	1.06	.9713	1.41	.8422
.72	1.1785	1.07	.9667	1.42	.8392
.73	1.1704	1.08	.9623	1.43	.8362
.74	1.1625	1.09	.9578	1.44	.8333
.75	1.1547	1.10	.9535	1.45	.8305
.76	1.1471	1.11	.9492	1.46	.8276
.77	1.1396	1.12	.9449	1.47	.8248
.78	1.1323	1.13	.9407	1.48	.8220
.79	1.1251	1.14	.9366	1.49	.8192
.80	1.1180	1.15	.9325	1.50	.8165
.81	1.1111	1.16	.9285	1.51	.8138
.82	1.1043	1.17	.9245	1.52	.8111
.83	1.0976	1.18	.9206	1.53	.8085
.84	1.0911	1.19	.9167	1.54	.8058
.85	1.0847	1.20	.9129	1.55	.8032
.86	1.0783	1.21	.9091	1.56	.8006
.87	1.0721	1.22	.9054	1.57	.7981
.88	1.0660	1.23	.9017	1.58	.7956
.89	1.0600	1.24	.8980	1.59	.7931
.90	1.0541	1.25	.8944	1.60	.7906

When the Specific Gravity is greater or less than 1.00 multiply the Coefficient by the multiplier opposite the new Specific Gravity if the Coefficient was based upon a Specific Gravity of 1.00. See Page 193.

MEASUREMENT OF GAS AND AIR

Table 45
SPECIFIC GRAVITY MULTIPLIERS

Where the Specific Gravity upon which the Coefficients were
calculated was .600.

Specific Gravity	Multiplier	Specific Gravity	Multiplier	Specific Gravity	Multiplier
.56	1.0351	.91	.8120	1.26	.6901
.57	1.0260	.92	.8076	1.27	.6873
.58	1.0171	.93	.8032	1.28	.6847
.59	1.0084	.94	.7989	1.29	.6820
.60	1.0000	.95	.7947	1.30	.6794
.61	.9918	.96	.7906	1.31	.6768
.62	.9837	.97	.7865	1.32	.6742
.63	.9759	.98	.7825	1.33	.6717
.64	.9682	.99	.7785	1.34	.6691
.65	.9608	1.00	.7746	1.35	.6667
.66	.9535	1.01	.7708	1.36	.6642
.67	.9463	1.02	.7670	1.37	.6618
.68	.9393	1.03	.7632	1.38	.6594
.69	.9325	1.04	.7596	1.39	.6570
.70	.9258	1.05	.7559	1.40	.6547
.71	.9193	1.06	.7524	1.41	.6523
.72	.9129	1.07	.7488	1.42	.6500
.73	.9066	1.08	.7454	1.43	.6478
.74	.9005	1.09	.7419	1.44	.6455
.75	.8944	1.10	.7385	1.45	.6433
.76	.8885	1.11	.7352	1.46	.6411
.77	.8827	1.12	.7319	1.47	.6389
.78	.8771	1.13	.7287	1.48	.6367
.79	.8715	1.14	.7255	1.49	.6346
.80	.8660	1.15	.7223	1.50	.6325
.81	.8607	1.16	.7192	1.51	.6304
.82	.8554	1.17	.7161	1.52	.6283
.83	.8502	1.18	.7131	1.53	.6262
.84	.8452	1.19	.7101	1.54	.6242
.85	.8402	1.20	.7071	1.55	.6222
.86	.8353	1.21	.7042	1.56	.6202
.87	.8305	1.22	.7013	1.57	.6182
.88	.8257	1.23	.6984	1.58	.6162
.89	.8211	1.24	.6956	1.59	.6143
.90	.8165	1.25	.6928	1.60	.6124

When the Specific Gravity is greater or less than .600 multiply the Coefficient by the multiplier opposite the new Specific Gravity if the Coefficient was based upon a Specific Gravity of .600. See Page 193.

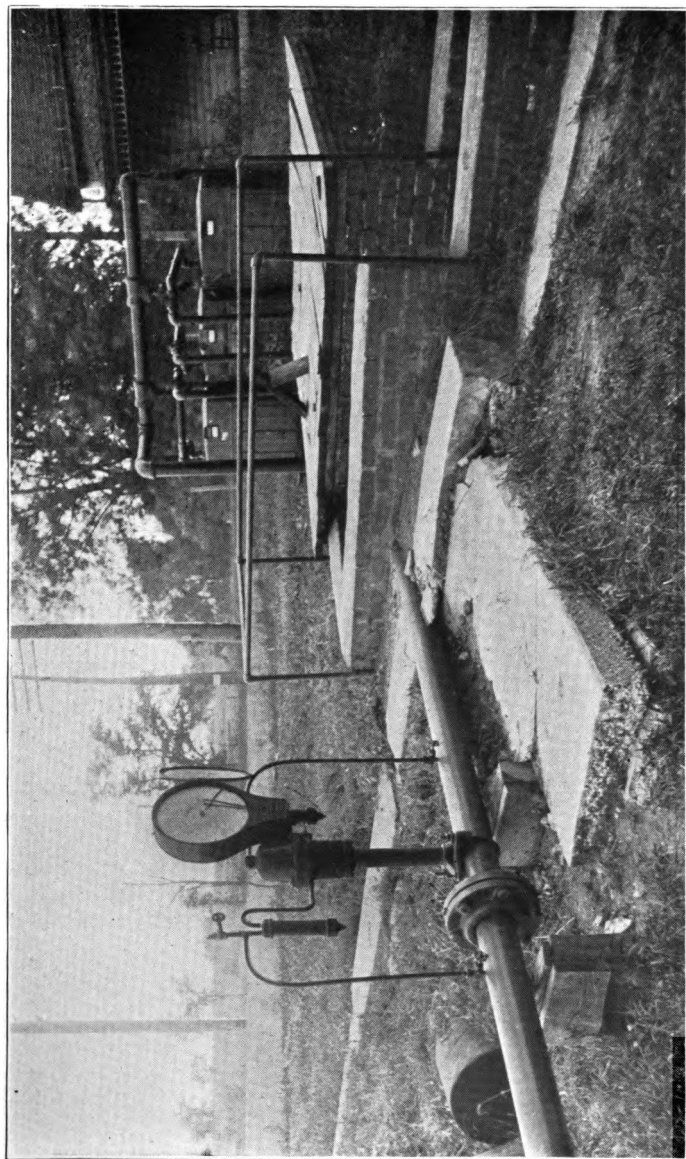

Fig. 77—MEASURING SAME GAS THROUGH AN ORIFICE METER AND THREE 60-A TIN METERS. SEE PAGE 219

SPECIFICATIONS FOR ORIFICE METER COMPUTATIONS FOR OSAGE NATION.*

Symbols Which Will Be Used Throughout

Q = Cubic feet of gas per hour at T_1, P_1 or at T_2, P_2 .

A = Affective area of flowing stream in square feet.

a = Area of orifice in square feet.

C = Coefficient of contraction, friction, etc. (Vc or Eff.)

d = Diameter of orifice in inches.

D = Diameter of pipe in inches.

V = Velocity of the flowing fluid feet per hour.

g = Acceleration of gravity at L and E .

H = Differential across orifice in feet of flowing fluid.

h = Differential across orifice in inches of water at 60 deg. fahr.

P_1 = Absolute pressure of flowing fluid pounds per square inch.

P_2 = Absolute pressure base or (reference pressure).

p = Atmospheric pressure absolute pounds per square inch.

T_1 = Absolute temperature of flowing fluid.

T_2 = Absolute temperature base or (reference temperature).

L = Average latitude of the field in which the gas is measured.

E = Average elevation above sea level of the field in which the gas is measured.

G = Specific gravity of gas flowing. (Compared to air at 14.4 lb. and 60 deg. fahr.)

$$X = \frac{d}{D}$$

\times = The sign of multiplication.

* H. R. Pierce.

**Assumptions in Figuring Hourly Gas Coefficients to be Used
with Orifice Meters.**

Measuring Gas in the Osage Nation

- C. For orifice meters where differential taps are taken 1 inch upstream from face of orifice disc and 1 inch from downstream face of orifice disc and pressure connection taken from downstream connection, is found from this formula:—

$$C = .606 + 1.25 (X - .41)^2 \quad \text{Where } X = .41 \text{ or more.}$$

For any value of X below .41, C is equal to a constant .606 (by Weymouth).

- C. For orifice meters when differential taps are taken 2.5 pipe diameters above upstream face of orifice disc, and downstream connection is made 8 pipe diameters below upstream face of disc. Pressure connection taken at upstream tap.

C is found from this formula;

$$C = (.58925 + .2725X - .825 X^2 + 1.75 X^3)$$

- 1 cubic foot water at 60 deg. fahr. weighs 62.37 lb.
1 cubic foot air at 14.4 lb. and 60 deg. fahr. weighs .0748378 lb.

Therefore, $\frac{62.37}{.0748378} = 833.40237$ feet of air at 14.4

and 60 deg. fahr. to equal in weight 1 foot of water at 60 deg. fahr.

Therefore, 1 inch of water = $\frac{833.40237}{12} = (69.45019$

feet of air at 14.4 lb. and 60 deg. fahr. to equal in weight 1 inch of water at 60 deg. fahr.)

MEASUREMENT OF GAS AND AIR

$$g = (\text{by Pierce's formula}) \quad 32.0894 (1 + .0052375 \sin^2 L) (1 - .0000000957E)$$

$L = 36 \text{ deg. } 45 \text{ min. N. Latitude}$ which is considered the average for the Osage.

$E = 1,000 \text{ ft.}$ above sea level, (considered average elevation for Osage).

$$g = 32.1465.$$

$p = 14.4 \text{ lb.}$ per square inch absolute.

$P_2 = 10 \text{ oz.}$ above atmospheric pressure or 15.025 lb. per square inch absolute. Considering the average atmospheric pressure to be 14.4.

$T_1 = 60 \text{ deg. fahr.}$ or 519.6 deg. absolute fahr.

$T_2 = 60 \text{ deg. fahr.}$ or 519.6 deg. absolute fahr.

Showing all figures used in deduction of Air and Gas Constant to be used in the Osage.

$$Q = AV$$

$$A = aC$$

$$a = \frac{3.1416 d^2}{4 \times 144}$$

$$V = 3600 \sqrt{2 \times 32.1465 H}$$

$$H = h \frac{69.45019}{P_1} \frac{14.4}{519.6} \frac{T_1}{519.6}$$

$$V = 3600 \sqrt{2 \times 32.1465 h \frac{69.45019}{P_1} \frac{14.4}{519.6} \frac{T_1}{519.6}}$$

$$Q = \left(\frac{3.1416 d^2}{4 \times 144} \right)$$

$$\left(3600 C \sqrt{2 \times 32.1465 h \frac{69.45019}{P_1} \frac{14.4}{519.6} \frac{T_1}{519.6}} \right)$$

Simplifying, we get:

$$Q = 218.422 Cd^2 \sqrt{h \frac{T_1}{P_1}}$$

To reduce Q to any desired P_2 or T_2 , we introduce $\frac{T_2}{T_1} \frac{P_1}{P_2}$

$$Q = 218.422 \frac{T_2}{T_1} \frac{P_1}{P_2} Cd^2 \sqrt{h \frac{T_1}{P_1}}$$

Canceling $\frac{P_1}{T_1}$, we have

$$Q = 218.422 \frac{T_2}{P_2} Cd^2 \sqrt{h \frac{P_1}{T_1}}$$

Considering T_2 and T_1 , 60 deg. fahr. or 519.6 deg. absolute fahr., we have

$$Q = 218.422 \frac{\sqrt{519.6}}{P_2} Cd^2 \sqrt{h P_1}$$

$$Q = \frac{4978.872045014}{P_2} Cd^2 \sqrt{h P_1}$$

Gravity of Gas 1.

Pressure Base of 0 oz. = 14.4 lb. Absolute.

$$Q = 345.755 Cd^2 \sqrt{h P_1}$$

Pressure Base of 4 oz. = 14.64 lb. Absolute.

$$Q = 340.087 Cd^2 \sqrt{h P_1}$$

Pressure Base of 6 oz. = 14.75 lb. Absolute.

$$Q = 337.551 Cd^2 \sqrt{h P_1}$$

Pressure Base of 8 oz. = 14.9 lb. Absolute.

$$Q = 334.152 Cd^2 \sqrt{h P_1}$$

MEASUREMENT OF GAS AND AIR

Pressure Base of 10 oz. = 15.025 lb. Absolute.

$$Q = 331.373 C d^2 \sqrt{h P_1}$$

Pressure Base of 1 lb. = 15.4 lb. Absolute.

$$Q = 323.303 C d^2 \sqrt{h P_1}$$

Pressure Base of 2 lb. = 16.4 lb. Absolute.

$$Q = 303.590 C d^2 \sqrt{h P_1}$$

To get Gas Constant divide air constant by the square root of the gravity of gas.

The inside diameter of standard pipe used in orifice meter settings, as a rule, is as follows:—

D for 4 inch pipe = 4.026.

D for 6 inch pipe = 6.065.

D for 8 inch pipe = 8.071.

D for 10 inch pipe = 10.191.

D for 12 inch pipe = 12.000.

Please note on meter setting reports if other than standard pipe is used giving inside diameter, weight, etc.

In reporting size of orifice please give nearest standard size with the actual micrometer of orifice to $\frac{1}{1000}$ inch.

Special

For taps 2.5 and 8 diameters with 10 oz. Pressure Base the one hour gas coefficient is derived from this formula:

$$\frac{331.373 d^2 (.58925 + .2725X - .825X^2 + 1.75X^3)}{\sqrt{\text{Specific gravity of the gas.}}}$$

For taps 1 inch and 1 inch with 10 oz. Pressure Base the one hour gas coefficient is derived from this formula:

$$\frac{331.373 d^2 [.606 + 1.25 (X - .41)^2]^{.75}}{\sqrt{\text{Specific gravity of the gas.}}}$$

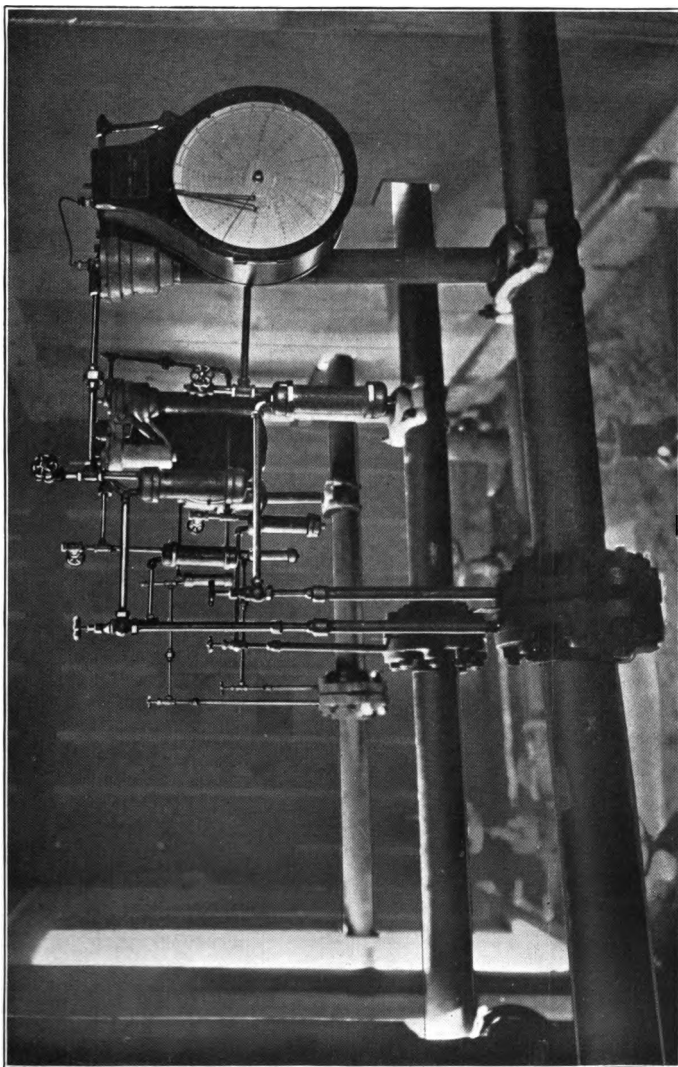

Fig. 78—MEASURING STATION. FLANGE CONNECTIONS.

MEASUREMENT OF GAS AND AIR

Table 46—VALUES OF C_v FOR $2\frac{1}{2}$ AND 8
DIAMETER CONNECTIONS

$$C_v = .58925 + .2725 X - .825 X^2 + 1.75 X^3 \quad X = \frac{\text{Diameter Orifice}}{\text{Actual Internal Diameter Pipe}}$$

From Page 203

X	C_v	X	C_v	X	C_v	X	C_v
.151	.617612	.201	.624903	.251	.633345	.301	.644251
.152	.617755	.202	.625056	.252	.633534	.302	.644503
.153	.617897	.203	.625209	.253	.633735	.303	.644757
.154	.618040	.204	.625364	.254	.633816	.304	.645012
.155	.618183	.205	.625518	.255	.634109	.305	.645269
.156	.618326	.206	.625674	.256	.634303	.306	.645527
.157	.618469	.207	.625829	.257	.634498	.307	.645787
.158	.618612	.208	.625985	.258	.634693	.308	.646049
.159	.618755	.209	.626142	.259	.634890	.309	.646312
.160	.618898	.210	.626299	.260	.635088	.310	.646577
.161	.619041	.211	.626457	.261	.635287	.311	.646843
.162	.619184	.212	.626615	.262	.635487	.312	.647111
.163	.619327	.213	.626774	.263	.635688	.313	.647381
.164	.619470	.214	.626934	.264	.635890	.314	.647652
.165	.619613	.215	.627094	.265	.636094	.315	.647925
.166	.619756	.216	.627255	.266	.636298	.316	.648199
.167	.619900	.217	.627416	.267	.636504	.317	.648475
.168	.620043	.218	.627578	.268	.636711	.318	.648753
.169	.620187	.219	.627741	.269	.636919	.319	.649033
.170	.620330	.220	.627904	.270	.637128	.320	.649314
.171	.620474	.221	.628068	.271	.637338	.321	.649597
.172	.620618	.222	.628232	.272	.637549	.322	.649881
.173	.620762	.223	.628398	.273	.637762	.323	.650168
.174	.620906	.224	.628564	.274	.637976	.324	.650456
.175	.621050	.225	.628730	.275	.638191	.325	.650746
.176	.621195	.226	.628896	.276	.638408	.326	.651038
.177	.621340	.227	.629066	.277	.638625	.327	.651331
.178	.621485	.228	.629235	.278	.638844	.328	.651626
.179	.621630	.229	.629404	.279	.639065	.329	.651923
.180	.621776	.230	.629575	.280	.639286	.330	.652222
.181	.621922	.231	.629746	.281	.639509	.331	.652523
.182	.622068	.232	.629918	.282	.639733	.332	.652825
.183	.622214	.233	.630090	.283	.639958	.333	.653130
.184	.622360	.234	.630264	.284	.640185	.334	.653436
.185	.622507	.235	.630438	.285	.640413	.335	.653744
.186	.622654	.236	.630613	.286	.640642	.336	.654054
.187	.622802	.237	.630789	.287	.640873	.337	.654366
.188	.622950	.238	.630966	.288	.641105	.338	.654679
.189	.623097	.239	.631144	.289	.641338	.339	.654995
.190	.623246	.240	.631322	.290	.641573	.340	.655312
.191	.623394	.241	.631501	.291	.641809	.341	.655631
.192	.623543	.242	.631681	.292	.642047	.342	.655953
.193	.623693	.243	.631863	.293	.642286	.343	.656276
.194	.623843	.244	.632045	.294	.642526	.344	.656601
.195	.623993	.245	.632227	.295	.642768	.345	.656928
.196	.624143	.246	.632412	.296	.643012	.346	.657257
.197	.624294	.247	.632596	.297	.643257	.347	.657589
.198	.624446	.248	.632782	.298	.643503	.348	.657922
.199	.624598	.249	.632969	.299	.643751	.349	.658257
.200	.624750	.250	.633156	.300	.644000	.350	.658594

See Page 171

MEASUREMENT OF GAS AND AIR

Table 47—VALUES OF C_v FOR $2\frac{1}{2}$ AND 8
DIAMETER CONNECTIONS

$$C_v = .58925 + .2725 X - .825 X^2 + 1.75 X^3 \quad X = \frac{\text{Diameter Orifice}}{\text{Actual Internal Diameter Pipe}}$$

From Page 203

X	C_v	X	C_v	X	C_v	X	C_v
.351	.658933	.401	.678704	.451	.704876	.501	.738762
.352	.659274	.402	.679180	.452	.705473	.502	.739527
.353	.659617	.403	.679619	.453	.706074	.503	.740296
.354	.659963	.404	.680090	.454	.706679	.504	.741069
.355	.660310	.405	.680545	.455	.707286	.505	.741845
.356	.660660	.406	.681011	.456	.707896	.506	.742625
.357	.661011	.407	.681481	.457	.708509	.507	.743409
.358	.661365	.408	.681953	.458	.709125	.508	.744196
.359	.661720	.409	.682427	.459	.709745	.509	.744987
.360	.662078	.410	.682904	.460	.710368	.510	.745782
.361	.662438	.411	.683384	.461	.710994	.511	.746580
.362	.662800	.412	.683866	.462	.711623	.512	.747382
.363	.663165	.413	.684351	.463	.712255	.513	.748188
.364	.663531	.414	.684839	.464	.712891	.514	.748998
.365	.663899	.415	.685330	.465	.713530	.515	.749811
.366	.664270	.416	.685823	.466	.714172	.516	.750628
.367	.664643	.417	.686319	.467	.714817	.517	.751449
.368	.665018	.418	.686818	.468	.715466	.518	.752273
.369	.665396	.419	.687320	.469	.716118	.519	.753102
.370	.665775	.420	.687824	.470	.716773	.520	.753934
.371	.666157	.421	.688331	.471	.717431	.521	.754770
.372	.666541	.422	.688841	.472	.718093	.522	.755610
.373	.666927	.423	.689353	.473	.718758	.523	.756453
.374	.667316	.424	.689869	.474	.719426	.524	.757301
.375	.667707	.425	.690386	.475	.720098	.525	.758152
.376	.668100	.426	.690908	.476	.720773	.526	.759008
.377	.668496	.427	.691431	.477	.721451	.527	.759867
.378	.668893	.428	.691958	.478	.722133	.528	.760730
.379	.669293	.429	.692487	.479	.722818	.529	.761596
.380	.669696	.430	.693020	.480	.723506	.530	.762467
.381	.670101	.431	.693555	.481	.724198	.531	.763342
.382	.670507	.432	.694093	.482	.724893	.532	.764220
.383	.670917	.433	.694634	.483	.725592	.533	.765103
.384	.671329	.434	.695178	.484	.726294	.534	.765990
.385	.671743	.435	.695724	.485	.726999	.535	.766880
.386	.672160	.436	.696274	.486	.727708	.536	.767775
.387	.672579	.437	.696827	.487	.728420	.537	.768673
.388	.673001	.438	.697382	.488	.729136	.538	.769575
.389	.673424	.439	.697941	.489	.729855	.539	.770482
.390	.673851	.440	.698502	.490	.730578	.540	.771392
.391	.674279	.441	.699066	.491	.731304	.541	.772306
.392	.674711	.442	.699634	.492	.732034	.542	.773225
.393	.675144	.443	.700204	.493	.732768	.543	.774147
.394	.675580	.444	.700777	.494	.733505	.544	.775074
.395	.676019	.445	.701354	.495	.734245	.545	.776004
.396	.676460	.446	.701933	.496	.734989	.546	.776939
.397	.676904	.447	.702516	.497	.735736	.547	.777878
.398	.677350	.448	.703101	.498	.736487	.548	.778821
.399	.677799	.449	.703690	.499	.737242	.549	.779768
.400	.678250	.450	.704281	.500	.738000	.550	.780719

See Page 171

C See 166

MEASUREMENT OF GAS AND AIR

**Table 48—VALUES OF C_v FOR $2\frac{1}{2}$ AND 8
DIAMETER CONNECTIONS**

$$C_v = .58925 + .2725 X - .825 X^2 + 1.75 X^3 \quad X = \frac{\text{Diameter Orifice}}{\text{Actual Internal Diameter Pipe}}$$

From Page 203

X	C_v	X	C_v	X	C_v	X	C_v
.551	.781674	.601	.834925	.651	.899827	.701	.977693
.552	.782633	.602	.836104	.652	.901253	.702	.979391
.553	.783597	.603	.837288	.653	.902694	.703	.981096
.554	.784564	.604	.838477	.654	.904120	.704	.982806
.555	.785536	.605	.839671	.655	.905562	.705	.984521
.556	.786512	.606	.840869	.656	.907009	.706	.986243
.557	.787492	.607	.842072	.657	.908461	.707	.987970
.558	.788477	.608	.843280	.658	.909918	.708	.989703
.559	.789465	.609	.844492	.659	.911380	.709	.991442
.560	.790458	.610	.845709	.660	.912848	.710	.993187
.561	.791455	.611	.846931	.661	.914321	.711	.994937
.562	.792456	.612	.848158	.662	.915799	.712	.996693
.563	.793462	.613	.849389	.663	.917283	.713	.998455
.564	.794472	.614	.850626	.664	.918772	.714	1.000223
.565	.795485	.615	.851866	.665	.920266	.715	1.001997
.566	.796504	.616	.853112	.666	.921766	.716	1.003777
.567	.797527	.617	.854363	.667	.923271	.717	1.005562
.568	.798553	.618	.855618	.668	.924781	.718	1.007354
.569	.799585	.619	.856879	.669	.926297	.719	1.009151
.570	.800620	.620	.858144	.670	.927818	.720	1.010954
.571	.801660	.621	.859414	.671	.929344	.721	1.012763
.572	.802704	.622	.860689	.672	.930876	.722	1.014578
.573	.803753	.623	.861969	.673	.932413	.723	1.016399
.574	.804806	.624	.863253	.674	.933956	.724	1.018226
.575	.805863	.625	.864543	.675	.935504	.725	1.020059
.576	.806925	.626	.865838	.676	.937058	.726	1.021898
.577	.807991	.627	.867137	.677	.938616	.727	1.023742
.578	.809062	.628	.868441	.678	.940181	.728	1.025593
.579	.810137	.629	.869751	.679	.941751	.729	1.027450
.580	.811216	.630	.871065	.680	.943326	.730	1.029312
.581	.812300	.631	.872384	.681	.944907	.731	1.031181
.582	.813388	.632	.873708	.682	.946493	.732	1.033056
.583	.814481	.633	.875037	.683	.948085	.733	1.034936
.584	.815578	.634	.876371	.684	.949683	.734	1.036823
.585	.816680	.635	.877711	.685	.951285	.735	1.038716
.586	.817786	.636	.879055	.686	.952894	.736	1.040615
.587	.818897	.637	.880404	.687	.954508	.737	1.042520
.588	.820012	.638	.881758	.688	.956127	.738	1.044431
.589	.821132	.639	.883118	.689	.957753	.739	1.046349
.590	.822256	.640	.884482	.690	.959383	.740	1.048272
.591	.823385	.641	.885851	.691	.961019	.741	1.050201
.592	.824518	.642	.887226	.692	.962661	.742	1.052137
.593	.825656	.643	.888606	.693	.964309	.743	1.054079
.594	.826798	.644	.889990	.694	.965962	.744	1.056027
.595	.827945	.645	.891380	.695	.967621	.745	1.057981
.596	.829097	.646	.892775	.696	.969286	.746	1.059941
.597	.830253	.647	.894175	.697	.970956	.747	1.061907
.598	.831414	.648	.895580	.698	.972631	.748	1.063880
.599	.832580	.649	.896991	.699	.974313	.749	1.065860
.600	.833750	.650	.898406	.700	.976000	.750	1.067844

See Page 171

MEASUREMENT OF GAS AND AIR

Table 49—VALUES OF C_v FOR FLANGE CONNECTIONS

$$C_v = .606 + 1.25 (X - .41)^2 \quad X = \frac{\text{Diameter of Orifice}}{\text{Actual Internal Diameter of Pipe}}$$

From Page 203

X	C_v	X	C_v	X	C_v	X	C_v
.150	.606000	.451	.608101	.501	.616351	.551	.630851
.200	.606000	.452	.608205	.502	.616580	.552	.631205
.250	.606000	.453	.608311	.503	.616811	.553	.631561
.300	.606000	.454	.608420	.504	.617045	.554	.631920
.350	.606000	.455	.608531	.505	.617281	.555	.632281
.400	.606000	.456	.608645	.506	.617520	.556	.632645
.405	.606000	.457	.608761	.507	.617761	.557	.633011
.408	.606000	.458	.608880	.508	.618005	.558	.633380
.409	.606000	.459	.609001	.509	.618251	.559	.633751
.410	.606000	.460	.609125	.510	.618500	.560	.634125
.411	.606001	.461	.609251	.511	.618751	.561	.634501
.412	.606005	.462	.609380	.512	.619005	.562	.634880
.413	.606011	.463	.609511	.513	.619261	.563	.635261
.414	.606020	.464	.609645	.514	.619520	.564	.635645
.415	.606031	.465	.609781	.515	.619781	.565	.636031
.416	.606045	.466	.609920	.516	.620045	.566	.636420
.417	.606061	.467	.610061	.517	.620311	.567	.636811
.418	.606080	.468	.610205	.518	.620580	.568	.637205
.419	.606101	.469	.610351	.519	.620851	.569	.637601
.420	.606125	.470	.610500	.520	.621125	.570	.638000
.421	.608151	.471	.610651	.521	.621401	.571	.638401
.422	.606180	.472	.610805	.522	.621680	.572	.638805
.423	.606211	.473	.610961	.523	.621961	.573	.639211
.424	.606245	.474	.611120	.524	.622245	.574	.639620
.425	.606281	.475	.611281	.525	.622531	.575	.640031
.426	.606320	.476	.611445	.526	.622820	.576	.640445
.427	.606361	.477	.611611	.527	.623111	.577	.640861
.428	.606405	.478	.611780	.528	.623405	.578	.641280
.429	.606451	.479	.611951	.529	.623701	.579	.641701
.430	.606500	.480	.612125	.530	.624000	.580	.642125
.431	.606551	.481	.612301	.531	.624301	.581	.642551
.432	.606605	.482	.612480	.532	.624605	.582	.642980
.433	.606661	.483	.612661	.533	.624911	.583	.643411
.434	.606720	.484	.612845	.534	.625220	.584	.643845
.435	.606781	.485	.613031	.535	.625531	.585	.644281
.436	.606845	.486	.613220	.536	.625845	.586	.644720
.437	.606911	.487	.613411	.537	.626161	.587	.645161
.438	.606980	.488	.613605	.538	.626480	.588	.645605
.439	.607051	.489	.613801	.539	.626801	.589	.646051
.440	.607125	.490	.614000	.540	.627125	.590	.646500
.441	.607201	.491	.614201	.541	.627451	.591	.646951
.442	.607280	.492	.614405	.542	.627780	.592	.647405
.443	.607361	.493	.614611	.543	.628111	.593	.647861
.444	.607445	.494	.614820	.544	.628445	.594	.648320
.445	.607531	.495	.615031	.545	.628781	.595	.648781
.446	.607620	.496	.615245	.546	.629120	.596	.649245
.447	.607711	.497	.615461	.547	.629461	.597	.649711
.448	.607805	.498	.615680	.548	.629805	.598	.650180
.449	.607901	.499	.615901	.549	.630151	.599	.650651
.450	.608000	.500	.616125	.550	.630500	.600	.651125

MEASUREMENT OF GAS AND AIR

Table 50—VALUES OF C_v FOR FLANGE CONNECTIONS

$$C_v = .606 + 1.25 (X - .41)^2 \quad X = \frac{\text{Diameter of Orifice}}{\text{Actual Internal Diameter of Pipe}}$$

From Page 203

X	C_v	X	C_v	X	C_v
.601	.651601	.651	.678601	.701	.711851
.602	.652080	.652	.679205	.702	.712580
.603	.652561	.653	.679811	.703	.713311
.604	.653045	.654	.680420	.704	.714045
.605	.653531	.655	.681031	.705	.714781
.606	.654020	.656	.681645	.706	.715520
.607	.654511	.657	.682261	.707	.716261
.608	.655005	.658	.682880	.708	.717005
.609	.655501	.659	.683501	.709	.717751
.610	.656000	.660	.684125	.710	.718500
.611	.656501	.661	.684751	.711	.719251
.612	.657005	.662	.685380	.712	.720005
.613	.657511	.663	.686011	.713	.720761
.614	.658020	.664	.686645	.714	.721520
.615	.658531	.665	.687281	.715	.722281
.616	.659045	.666	.687920	.716	.723045
.617	.659561	.667	.688561	.717	.723811
.618	.660080	.668	.689205	.718	.724580
.619	.660601	.669	.689851	.719	.725351
.620	.661125	.670	.690500	.720	.726125
.621	.661651	.671	.691151	.721	.726901
.622	.662180	.672	.691805	.722	.727680
.623	.662711	.673	.692461	.723	.728461
.624	.663245	.674	.693120	.724	.729245
.625	.663781	.675	.693781	.725	.730031
.626	.664320	.676	.694445	.726	.730820
.627	.664861	.677	.695111	.727	.731611
.628	.665405	.678	.695780	.728	.732405
.629	.665951	.679	.696451	.729	.733201
.630	.666500	.680	.697125	.730	.734000
.631	.667051	.681	.697801	.731	.734801
.632	.667605	.682	.698480	.732	.735605
.633	.668161	.683	.699161	.733	.736411
.634	.668720	.684	.699845	.734	.737220
.635	.669281	.685	.700531	.735	.738031
.636	.669845	.686	.701220	.736	.738845
.637	.670411	.687	.701911	.737	.739661
.638	.670980	.688	.702605	.738	.740480
.639	.671551	.689	.703301	.739	.741301
.640	.672125	.690	.704000	.740	.742125
.641	.672701	.691	.704701	.741	.742951
.642	.673280	.692	.705405	.742	.743780
.643	.673861	.693	.706111	.743	.744611
.644	.674445	.694	.706820	.744	.745445
.645	.675031	.695	.707531	.745	.746281
.646	.675620	.696	.708245	.746	.747120
.647	.676211	.697	.708961	.747	.747961
.648	.676805	.698	.709680	.748	.748805
.649	.677401	.699	.710401	.749	.749651
.650	.678000	.700	.711125	.750	.750500

MEASUREMENT OF GAS AND AIR

**Table 51—HOURLY ORIFICE COEFFICIENTS
FOR GAS AND AIR**

Pressures taken at Flanges, Standard Pipe, Page 206.

Atmospheric Pressure 14.4

Base and Flowing Temperature 60 deg. Fahr.

Pressure Base 0 lb.

Specific Gravity 1.000

Diameter of Orifice Inches	DIAMETER OF PIPE LINE				
	4"	6"	8"	10"	12"
1/2	52.3819	52.3819	52.3819	52.3819	52.3819
5/8	81.8467	81.8467	81.8467	81.8467	81.8467
3/4	117.859	117.859	117.859	117.859	117.859
7/8	160.420	160.420	160.420	160.420	160.420
1	209.528	209.528	209.528	209.528	209.528
1 1/8	265.183	265.183	265.183	265.183	265.183
1 1/4	327.387	327.387	327.387	327.387	327.387
1 3/8	396.138	396.138	396.138	396.138	396.138
1 1/2	471.437	471.437	471.437	471.437	471.437
1 5/8	553.283	553.283	553.283	553.283	553.283
1 3/4	642.484	641.678	641.678	641.678	641.678
1 7/8	741.338	736.620	736.620	736.620	736.620
2	851.126	838.110	838.110	838.110	838.110
2 1/8	973.238	946.148	946.148	946.148	946.148
2 1/4	1109.22	1060.74	1060.74	1060.74	1060.74
2 3/8	1260.77	1181.86	1181.86	1181.86	1181.86
2 1/2	1429.76	1309.56	1309.55	1309.55	1309.55
2 5/8	1618.20	1445.33	1443.78	1443.78	1443.78
2 3/4	1828.25	1590.71	1584.55	1584.55	1584.55
2 7/8	2062.25	1746.52	1731.88	1731.88	1731.88
3	2322.68	1913.62	1885.75	1885.75	1885.75
3 1/4	2285.45	2213.14	2213.14	2213.14
3 1/2	2714.51	2569.67	2566.71	2566.71
3 3/4	3210.19	2964.62	2946.48	2946.48
4	3782.97	3403.11	3352.44	3352.44
4 1/4	4444.48	3890.68	3784.97	3784.59
4 1/2	5207.37	4433.47	4251.65	4242.93
4 3/4	5038.25	4758.16	4727.47
5	5712.42	5308.43	5238.67
5 1/4	6463.97	5906.84	5784.11
5 1/2	7301.55	6558.11	6368.75
5 3/4	8234.42	7267.37	6995.86
6	9272.46	8040.14	7669.02
6 1/4	8882.33	8392.05
6 1/2	9800.26	9169.10
6 3/4	10800.57	10004.55
7	11890.4	10903.11
7 1/4	13077.1	11869.7
7 1/2	14368.7	12909.7
8	15231.9
8 1/2	17917.6
9	21018.7

Based on $345.755 d^2 [.606 + 1.25 (X - .41)^2]$ Page 205.

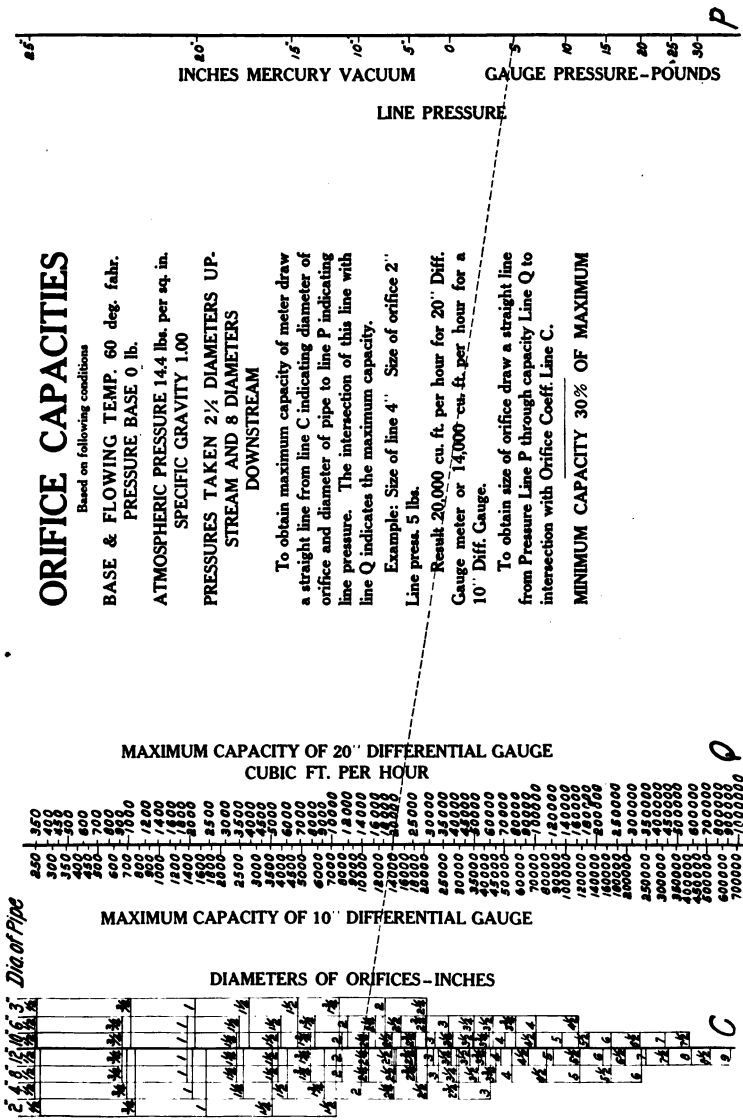

ORIFICE CAPACITIES

Based on following conditions

- BASE & FLOWING TEMP. 60 deg. fabr.
- PRESSURE BASE 0 lb.
- ATMOSPHERIC PRESSURE 14.4 lb. per sq. in.
- SPECIFIC GRAVITY 1.00

PRESSURES TAKEN 2 1/2 DIAMETERS UP.
STREAM AND 8 DIAMETERS DOWNSTREAM

To obtain maximum capacity of meter draw a straight line from line C indicating diameter of orifice and diameter of pipe to line P indicating line pressure. The intersection of this line with line Q indicates the maximum capacity.

Example: Size of line 4" Size of orifice 2" Line press. 5 lbs.
Result 20,000 cu. ft. per hour for 20" Diff. Gauge meter or 14,000 cu. ft. per hour for a 10" Diff. Gauge.

To obtain size of orifice draw a straight line from Pressure Line P through capacity Line Q to intersection with Orifice Coeff. Line C.

MINIMUM CAPACITY 30% OF MAXIMUM

MAXIMUM CAPACITY OF 20" DIFFERENTIAL GAUGE
CUBIC FT. PER HOUR

250	350
300	450
350	550
400	650
450	750
500	850
600	1000
700	1150
800	1300
900	1450
1000	1600
1200	1800
1400	2000
1600	2200
1800	2400
2000	2600
2500	3200
3000	3800
3500	4400
4000	5000
4500	5600
5000	6200
6000	7200
7000	8200
8000	9200
9000	10200
10000	11200
12000	13000
14000	14800
16000	16600
18000	18400
20000	20200
25000	24000
30000	28000
35000	32000
40000	36000
45000	40000
50000	44000
55000	48000
60000	52000
65000	56000
70000	60000
75000	64000
80000	68000
85000	72000
90000	76000
95000	80000
100000	84000

MAXIMUM CAPACITY OF 10" DIFFERENTIAL GAUGE

DIAMETERS OF ORIFICES - INCHES

1/8	1/4	3/8	1/2	5/8	3/4	7/8	1	1 1/8	1 1/4	1 1/2	1 3/4	2	2 1/4	2 1/2	3	3 1/4	3 1/2	4	4 1/4	4 1/2	5	5 1/4	5 1/2	6	6 1/4	6 1/2	7	7 1/4	7 1/2	8	8 1/4	8 1/2	9	9 1/4	9 1/2	10	10 1/4	10 1/2	11	11 1/4	11 1/2	12
-----	-----	-----	-----	-----	-----	-----	---	-------	-------	-------	-------	---	-------	-------	---	-------	-------	---	-------	-------	---	-------	-------	---	-------	-------	---	-------	-------	---	-------	-------	---	-------	-------	----	--------	--------	----	--------	--------	----

Fig. 79

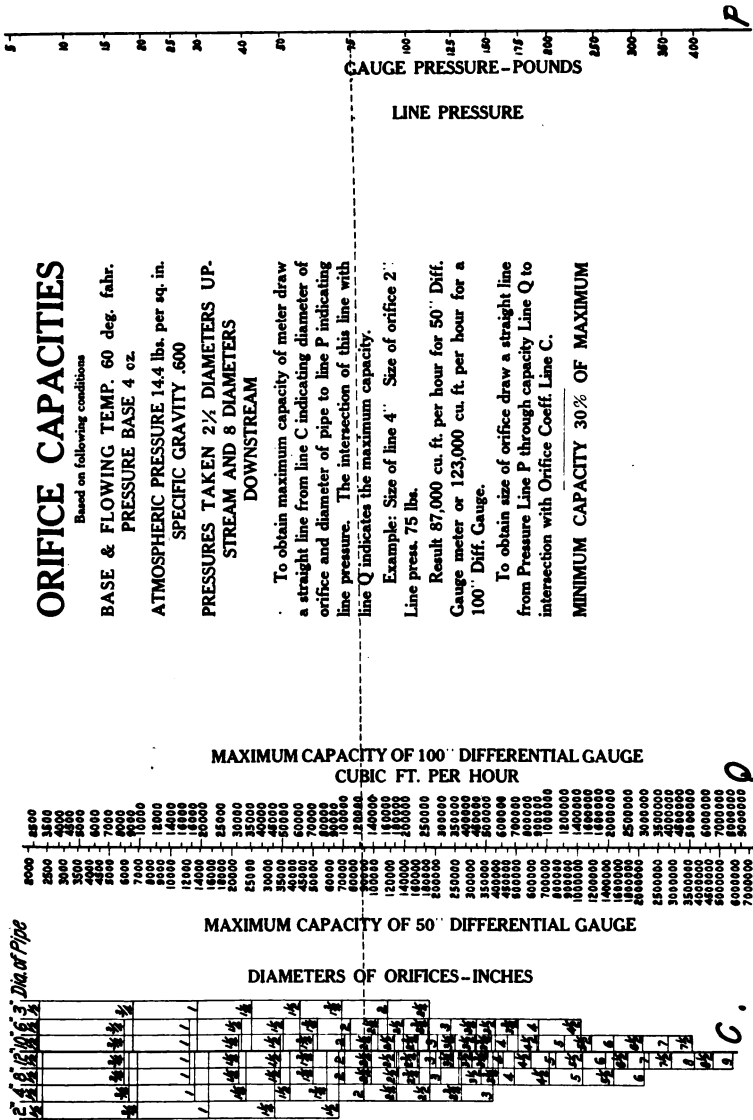

ORIFICE CAPACITIES

Based on following conditions

BASE & FLOWING TEMP. 60 deg. Fahr.
PRESSURE BASE 4 oz.

ATMOSPHERIC PRESSURE 14.4 lbs. per sq. in.
SPECIFIC GRAVITY .600

PRESSURES TAKEN 2 1/2 DIAMETERS UP-STREAM AND 8 DIAMETERS DOWNSTREAM

To obtain maximum capacity of meter draw a straight line from line C indicating diameter of orifice and diameter of pipe to line P indicating line pressure. The intersection of this line with line Q indicates the maximum capacity.

Example: Size of line 4" Size of orifice 2" Line press. 75 lbs.

Result 87,000 cu. ft. per hour for 50" Diff. Gauge meter or 123,000 cu. ft. per hour for a 100" Diff. Gauge.

To obtain size of orifice draw a straight line from Pressure Line P through capacity Line Q to intersection with Orifice Coeff. Line C.

MINIMUM CAPACITY 30% OF MAXIMUM

MAXIMUM CAPACITY OF 100" DIFFERENTIAL GAUGE CUBIC FT. PER HOUR

8000	8200
2500	3150
3000	4000
3500	4850
4000	5700
4500	6550
5000	7400
5500	8250
6000	9100
6500	9950
7000	10800
7500	11650
8000	12500
8500	13350
9000	14200
9500	15050
10000	15900
10500	16750
11000	17600
11500	18450
12000	19300
12500	20150
13000	21000
13500	21850
14000	22700
14500	23550
15000	24400
15500	25250
16000	26100
16500	26950
17000	27800
17500	28650
18000	29500
18500	30350
19000	31200
19500	32050
20000	32900
20500	33750
21000	34600
21500	35450
22000	36300
22500	37150
23000	38000
23500	38850
24000	39700
24500	40550
25000	41400
25500	42250
26000	43100
26500	43950
27000	44800
27500	45650
28000	46500
28500	47350
29000	48200
29500	49050
30000	49900
30500	50750
31000	51600
31500	52450
32000	53300
32500	54150
33000	55000
33500	55850
34000	56700
34500	57550
35000	58400
35500	59250
36000	60100
36500	60950
37000	61800
37500	62650
38000	63500
38500	64350
39000	65200
39500	66050
40000	66900
40500	67750
41000	68600
41500	69450
42000	70300
42500	71150
43000	72000
43500	72850
44000	73700
44500	74550
45000	75400
45500	76250
46000	77100
46500	77950
47000	78800
47500	79650
48000	80500
48500	81350
49000	82200
49500	83050
50000	83900
50500	84750
51000	85600
51500	86450
52000	87300
52500	88150
53000	89000
53500	89850
54000	90700
54500	91550
55000	92400
55500	93250
56000	94100
56500	94950
57000	95800
57500	96650
58000	97500
58500	98350
59000	99200
59500	100050
60000	100900
60500	101750
61000	102600
61500	103450
62000	104300
62500	105150
63000	106000
63500	106850
64000	107700
64500	108550
65000	109400
65500	110250
66000	111100
66500	111950
67000	112800
67500	113650
68000	114500
68500	115350
69000	116200
69500	117050
70000	117900

MAXIMUM CAPACITY OF 50" DIFFERENTIAL GAUGE

DIAMETERS OF ORIFICES - INCHES

1	1.1	1.2	1.3	1.4	1.5	1.6	1.7	1.8	1.9	2	2.1	2.2	2.3	2.4	2.5	2.6	2.7	2.8	2.9	3	3.1	3.2	3.3	3.4	3.5	3.6	3.7	3.8	3.9	4	4.1	4.2	4.3	4.4	4.5	4.6	4.7	4.8	4.9	5	5.1	5.2	5.3	5.4	5.5	5.6	5.7	5.8	5.9	6	6.1	6.2	6.3	6.4	6.5	6.6	6.7	6.8	6.9	7	7.1	7.2	7.3	7.4	7.5	7.6	7.7	7.8	7.9	8	8.1	8.2	8.3	8.4	8.5	8.6	8.7	8.8	8.9	9	9.1	9.2	9.3	9.4	9.5	9.6	9.7	9.8	9.9	10
---	-----	-----	-----	-----	-----	-----	-----	-----	-----	---	-----	-----	-----	-----	-----	-----	-----	-----	-----	---	-----	-----	-----	-----	-----	-----	-----	-----	-----	---	-----	-----	-----	-----	-----	-----	-----	-----	-----	---	-----	-----	-----	-----	-----	-----	-----	-----	-----	---	-----	-----	-----	-----	-----	-----	-----	-----	-----	---	-----	-----	-----	-----	-----	-----	-----	-----	-----	---	-----	-----	-----	-----	-----	-----	-----	-----	-----	---	-----	-----	-----	-----	-----	-----	-----	-----	-----	----

Fig. 80

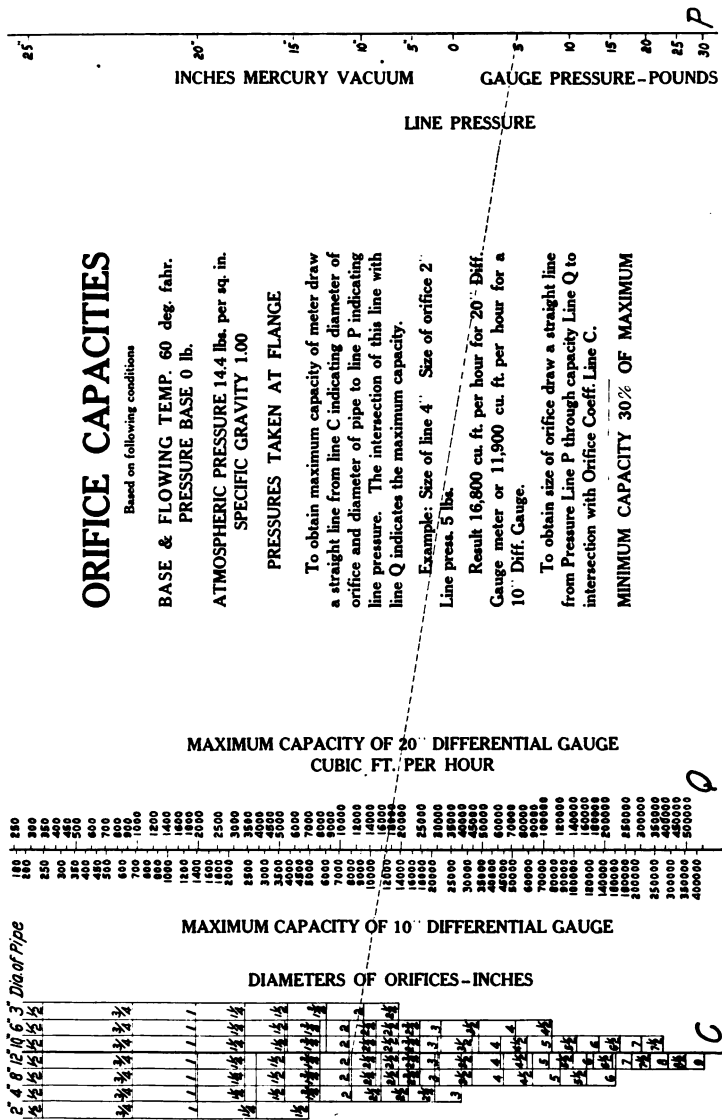

Fig. 81

MEASUREMENT OF GAS AND AIR

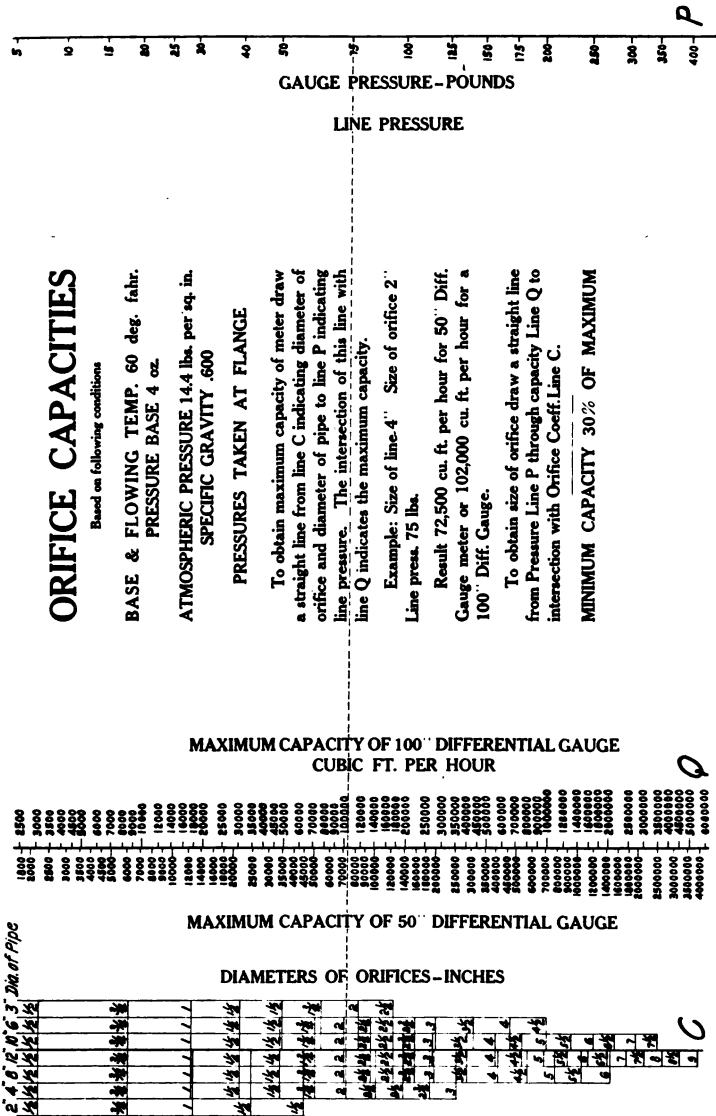

Fig. 82



Fig. 83—20 INCH DIFFERENTIAL GAUGE

MEASURING GAS IN LARGE VOLUMES*

"The following information was compiled from records obtained under ordinary operating conditions.

Data obtained at the city gates of Lawrence, Kansas, where the Kansas Natural Gas Company maintains two orifice meter settings—one in a 6 inch line and the other in an 8 inch line:—After the gas passes through the orifice meters it is again measured through a 100,000 cu. ft. per hour Thomas electric meter and, covering a period of 444 days, there was 342,156,000 cu. ft. registered through the orifice meters, 343,108,000 cu. ft. registered through the Thomas electric meter, a difference of 952,000 cu. ft., or a difference in percentage of 0.28 (twenty-eight one-hundredths of one per cent).

Data which was obtained at the city gates of Leavenworth, Kansas, where the Kansas Natural Gas Company maintains a 10 inch orifice meter setting:—After the gas passes through the orifice meter it is then measured through a 100,000 cu. ft. per hour Thomas electric meter and, covering a period of 252 days, there was 186,251,000 cu. ft. registered through the orifice meter, and 185,969,000 cu. ft. registered through the Thomas electric meter, a difference of 282,000 cu. ft. or a difference in percentage of 0.15 (fifteen one-hundredths of one per cent).

Comparative runs under ordinary operating conditions, at a 4 inch orifice meter setting measuring gas to an isolated portion of the Wyandotte County Gas Company's distribution system in Rosedale, Kansas, supplying about two hundred domestic consumers:—After the gas passed through the orifice meter it was again measured through three 60-A tin meters (1800 cu. ft. per hour each) and, covering a period of 120 days, there was registered by the orifice meter 4,553,840 cu. ft., and through the three 60-A tin meters 4,480,380 cu. ft., a difference of 73,460 cu. ft., or a difference in per-

* By V. C. Jarboe

MEASUREMENT OF GAS AND AIR

centage of 1.61 (one and sixty-one one-hundredths per cent). The differential carried on this orifice meter varied from 2 inches at night to about 48 inches during the peak, or meal-time load.

Taking into consideration the figures closed as of February 25th, 1922, at the city gates of Lawrence, Kansas, covering a period of 750 days, the orifice meters registered 547,759,000 cu. ft., the Thomas meter 548,417,000 cu. ft., a difference of 658,000 cu. ft. or a difference in percentage of 0.12 (twelve one-hundredths of one per cent).

The figures closed as of February 25th, 1922, at the city gates of Leavenworth, Kansas, covering a period of 527 days, the orifice meter registered 357,978,000 cu. ft., the Thomas meter 357,961,000 cu. ft., a difference of 17,000 cu. ft.

During all of this operation the meters were given the ordinary attention that meters should be given in order to get dependable measurements.

The Thomas meters referred to above are the property of the Lawrence and Leavenworth Gas Companies, and the three 60-A tin meters are the property of the Wyandotte County Gas Company."

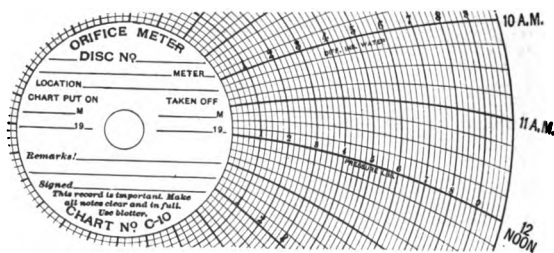

Fig. 84.—SECTION OF 10 INCH, 10 LB. ORIFICE METER CHART

EFFECT OF ATMOSPHERIC PRESSURE ON GAS MEASUREMENT

The volume of gas measured is expressed at a certain pressure base, which is usually designated as a certain number of ounces or pounds per square inch. This pressure is the gauge pressure above the atmospheric pressure at the point of measurement unless otherwise designated by contract or common understanding.

The standard practice has been to consider atmospheric pressure as 14.4 lb. per square inch. While it is true that this value is a representative one for most of the gas fields, gas is being produced in large volumes in locations of high altitude where the pressure of the atmosphere is 11.9 pounds per square inch and even less.

Where the atmospheric pressure is 14.4 lb. per square inch and gas is measured at an 8 ounce base, the total or absolute pressure base in pounds per square inch, is 14.4 lb. plus 8 ounces (0.5 lb.) or 14.9 lb. per square inch. However, at 11.9 lb. atmospheric pressure, the same 8 ounce pressure base represents an absolute pressure of 11.9 lb. plus 8 ounces (0.5 lb.) or 12.4 lb. per square inch, so that with temperature conditions similar, the weight of gas in a cubic foot in the first instance is approximately 20 per cent greater than in the second.

If the gas being produced at the higher altitude were piped to a lower altitude, the calculated volume decreases if the same pressure base is used for measurement above the atmospheric pressure at each point. Using the two values above cited, 600,000 cu. ft. measured at 8 oz. above 11.9 lb. atmospheric pressure would become only 500,000 cu. ft. at the 14.4 lb. pressure at an 8 ounce base. The weight does not change neither does the heat content.

The value of gas consists mainly of its heat producing quality. Although it is not purchased or sold on this basis directly, this condition is approached in high pressure meas-

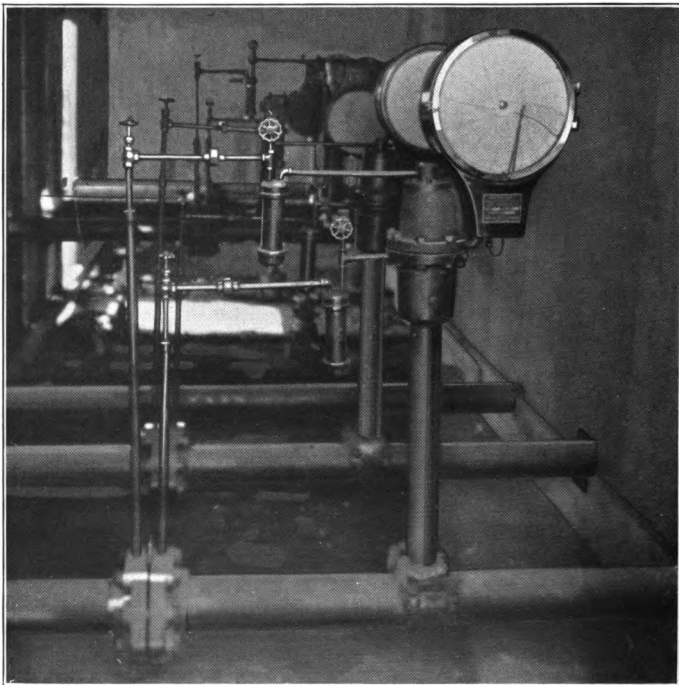

*Fig. 85—ORIFICE METER INSTALLATION, FLANGE
TAP CONNECTIONS*

urement, by contract requirements of a certain pressure base and base temperature at which the volume shall be calculated. If all gas had the same specific gravity the above method of measurement would insure the same weight of gas in each cubic foot. However, the heat content varies with the chemical constituents of the gas, so that the only manner in which gas could be sold on a heat or B. t. u. basis would be to have a combustion analysis made. Such an analysis is not usually made but for practical purposes gas and fuel oil are used under the same or similar boilers at the same load to determine the relative economy of the two fuels.

A barrel of fuel oil will weigh nearly the same regardless of atmospheric pressure so that in comparing fuel oil with gas it is necessary to know the absolute pressure under which the gas volume is expressed. If the gas measured at 8 ounces above a atmosphere of 11.9 lb. or 12.4 lb. per square inch absolute contained 800 B. t. u. per cubic foot, the same gas measured at 8 ounces above 14.4 or 14.9 lb. absolute would contain 960 B. t. u. per cubic foot. Assuming the barrel of fuel oil contained 4,800,000 B. t. u. it would be equivalent to 6,000 cu. ft. measured at 12.4 lb. absolute and 5,000 cu. ft. measured at 14.9 absolute. So that in making comparisons, the atmospheric pressure may become an important factor.

The above examples illustrate what an important part atmospheric pressure plays in gas measurement at high altitudes.

For purposes of comparison gas must be calculated on the same absolute pressure base. The Department of Interior have issued regulations in regard to this subject in "Regulations to Govern the Production of Oil and Gas,"* which provides that all gas must be reported on a base of 10 oz. above an atmospheric pressure of 14.4 lb. per sq. in. or 15.025 lb. absolute. The effect of the atmospheric pres-

* See Page 232

sure on the absolute pressure base only affects the value of the Coefficient. If the atmospheric pressure varies from 14.4 and it is desired to measure the gas at a certain number of ounces or pounds above the atmosphere, the Coefficient must be revised if it was derived by using 14.4 as the atmospheric pressure, for the Coefficient C is equal to:—

$$KC_v d^2 \frac{T_b}{P_b \sqrt{GT}}$$

Where P_b is the pressure base in pounds per square inch absolute. It is readily seen that as P_b decreases in value; C increases, and consequently the calculated volume increases. The formula for revision of the Coefficient is given on Page 189 and Table of Multipliers on Page 196.

When it is desired to measure gas at a pressure base above a pressure of 14.4 so that the volume would be equal to that which would occur if the pressure were 14.4 regardless of the atmospheric pressure at point of measurement, then the Coefficient should not be revised, on account of the different atmospheric pressure, if the Coefficient was derived by using 14.4. The reader is referred to Contracts, Page 230, for interpretations of various phrases regarding pressure base and atmospheric pressure.

In addition to the effect on the basis of measurement, the pressure of the atmosphere also affects the quantity due to the absolute pressure of the gas being measured. The quantity of gas when measured by an orifice meter is

$$Q = C \sqrt{hP}$$

where Q = quantity in cubic feet per hour passing the orifice.

C = Hourly Orifice Coefficient of the orifice. The value of this term is affected by the pressure base and any factor which affects the value of the pressure base in absolute units.

h = differential in inches of water.

P = Static or line pressure expressed in pounds per square inch absolute which is the atmospheric pressure plus or minus the gauge pressure.*

The static pressure or line pressure in pounds per square inch or in inches of mercury vacuum is usually recorded on the same chart as the differential pressure.

When orifice meters were first commercially used, the average atmospheric pressure of all the gas fields was 14.4 lb. and this value was used and is still used in the preparation of tables of Pressure Extensions, which tables give the values of \sqrt{hP} for various values of differential in combination with various pressures. In these tables P is equal to 14.4 plus the gauge pressure, and in cases of vacuum lines, P equals 14.4 minus .4908 times inches of mercury vacuum. 14.4 lb. is considered the atmospheric pressure.

It is readily understood that if the atmospheric pressure varies from 14.4, the volume will be affected. For example, if the gas is flowing under an atmospheric pressure of 11.9 or 2.5 lb. below 14.4 and the static pen rested at zero without any previous adjustment, the pressure on the gas would be equivalent to a minus pressure or 5 inches vacuum below an absolute pressure of 14.4 lb.

If the tables of Pressure Extensions are used without any adjustment for change of atmospheric pressure the error in this case is $\sqrt{(14.4+0)h}$ compared with $\sqrt{(11.9+0)h}$ or $3.795h$ compared with $3.456h$, being 10 per cent error. At 125 lb. the error is about 1 per cent $\sqrt{(14.4+125)h}=11.81h$, and $\sqrt{(11.9+125)h}=11.70h$. At 500 lb. the error is one-fourth per cent. However, under a vacuum the error increases as the vacuum increases. At 20 inches of mercury vacuum the error is 46 per cent.

$$\sqrt{(14.4 - .4908 \times 20)h} = 2.14h$$

$$\sqrt{(11.9 - .4908 \times 20)h} = 1.46h$$

* See Page 169.

The book of Pressure Extensions may be used by making adjustments either to the readings or to the static gauge.

When the atmospheric pressure is less than 14.4 make a deduction from the static reading equal to the amount that the atmospheric pressure is less than 14.4. For example, where the atmospheric pressure is 2.5 lb. less than 14.4 or 11.9 lb. subtract 2.5 lb. from all gauge readings. When the gauge reading for a period is 20.5 lb. and differential is 30 inches, look up the extension of 20.5—2.5 lb. or 18 lb., and 30 inches differential. This method may be proved thus:

$$\begin{aligned}\sqrt{(11.9+20.5)30} &= \sqrt{(14.4+18)30} \\ \sqrt{32.4 \times 30} &= \sqrt{32.4 \times 30}\end{aligned}$$

In cases of vacuum, add numerically to the gauge reading in inches of mercury, the difference between 29.3 inches mercury (14.4 lb.) and the barometric reading. If the barometric reading is 24.3 inches (11.9 lb.) the difference is 5 inches, then if the static reading is 20 inches and the differential is 10 inches, to obtain proper volume for the period look up the extension of 20 plus 5 or 25 inches of mercury vacuum and 10 inches differential.

$$\begin{aligned}\text{For } \sqrt{(11.9-.4908 \times 20)10} &= \sqrt{(14.4-.4908 \times 25)10} \\ \sqrt{(11.9-9.8)10} &= \sqrt{(14.4-12.3)10} \\ \sqrt{2.1 \times 10} &= \sqrt{2.1 \times 10}\end{aligned}$$

Adjustments may be made on the gauge to save all office work. When the atmospheric pressure is less than 14.4, install the recording differential and static gauge with the static pen located a space below the zero line equal to the number of pounds that the pressure of the atmosphere is less than 14.4. Thus, when the atmospheric pressure is 11.9 set the static pen 2.5 lb. below zero when the gauge is open to

the air. When a pressure acts on the gauge and the gauge registers 0, the absolute pressure will be $11.9+2.5$ or 14.4 which corresponds to the absolute pressure for 0 lb. in the pressure extension tables. Where the reading is 10 lb. the absolute pressure registered by the pen is $12.5+11.9=24.4$ lb. per square inch absolute, which is the absolute pressure corresponding to 10 lb. in the Pressure Extension Book. Gauges on vacuum lines are adjusted in a similar manner. If the barometer reading is 24.3 inches (11.9 lb.) which is 5 inches of mercury less than 29.3 inches (14.4 lb.) set the pen at 5 inches of mercury vacuum (below the zero line) when the gauge is installed or when open to the atmosphere. When the chart reading is 20 inches of vacuum the pressure is 15 inches below the atmosphere (24.3 less 15) or 9.3 inches absolute which is the same absolute pressure used in calculating the pressure extension ($29.3-20=9.3$) except that this value is expressed in pounds in making the calculations. When the atmospheric pressure is greater than 14.4 adjustments are made in the opposite manner. For instance if the atmospheric pressure is 14.7 lb. add 0.3 lb. to the static pressure readings before looking up the extensions. If on a vacuum line subtract 0.6 inches of mercury from the gauge reading before obtaining the extension. If it is desired to have the change made by the gauge so as to use the Pressure Extension Tables without any further trouble set the static pen to read 0.3 lb. or 0.6 inches of mercury above the zero when the gauge is open to the atmosphere.

Do not make revisions to both the readings and the gauge but only to the one or the other. When adjustments are made notations should be shown on charts and reports so that checkers may be able to make calculations in proper manner.

From the preceding discussion it will be noted that the effect of the atmospheric pressure on the pressure base, creates a constant percentage deviation on the quantity

and the effect on the static pressure is variable. The following examples indicate the varying results which may be obtained from the same data.

Gas being measured with pressure connections at $2\frac{1}{2}$ and 8 diameters from the orifice. Period one day.

Size of line, 8 inches. Diameter of Orifice, 6 inches.
 Pressure Base, 4 oz. Specific Gravity, .600.
 Atmospheric Pressure 12.4 lb. Temperature 60 deg. fahr.
 Unrevised Hourly Coefficient is 16664, see Page 175.
 Average Gauge Pressure 10 lb.
 Average Differential Pressure 16 inches.
 Gauge not adjusted.

(1) Coefficient revised, Pressure Extensions not revised.

$$Q = 24 \times 16664 \frac{(14.4 + .25)^*}{(12.4 + .25)} \sqrt{(14.4 + 10)16} = 9,152,000 \text{ cu. ft. per day.}$$

(2) Coefficient and Pressure Extension revised.

$$Q = 24 \times 16664 \frac{(14.4 + .25)^*}{(12.4 + .25)} \sqrt{(14.4 + 8)16} = 8,768,000 \text{ cu. ft. per day.}$$

(3) Coefficient not revised, Pressure Extension not revised.

$$Q = 24 \times 16664 \sqrt{(14.4 + 10)16} = 7,927,000 \text{ cu. ft. per day.}$$

(4) Coefficient not revised. Pressure Extension revised.

$$Q = 24 \times 16664 \sqrt{(14.4 + 8)16} = 7,572,000 \text{ cu. ft. per day.}$$

Whether method (2) or (4) should be applied depends upon the contract.

* See Page 189 for revision of coefficient for change of atmospheric pressure.

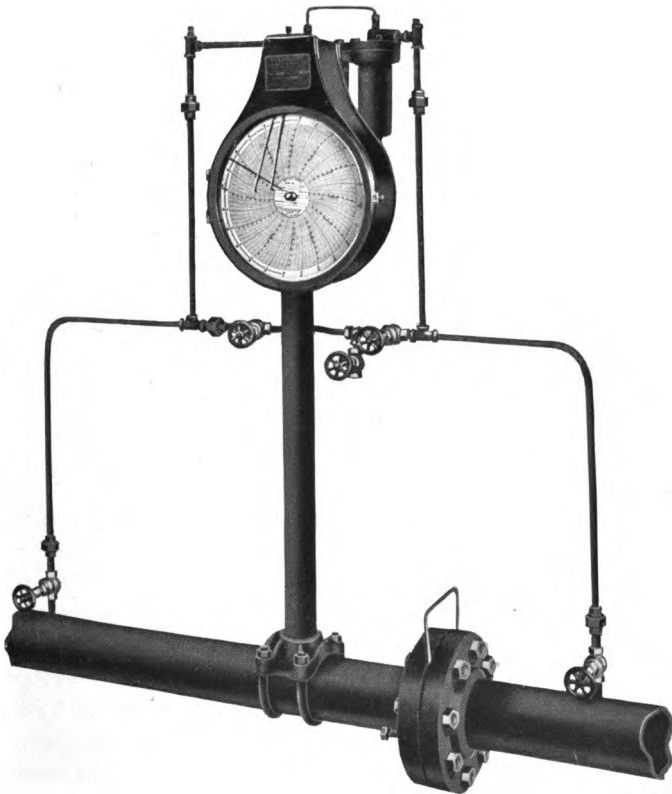

*Fig. 86—ORIFICE, FLANGES AND 50 INCH DIFFERENTIAL GAUGE
INSTALLATION. PIPE TAP CONNECTIONS. NOTE BY-PASS
BETWEEN GAUGE LINES*

GAS CONTRACTS

All true contracts begin with an agreement. By agreement is meant the meeting of the minds of the contracting parties in a common assent to the same definite conclusion. In order that the agreement may cover completely all points over which doubt may arise it should be drawn up as complete as possible.

The following are specimen clauses which appear in gas leases regarding the methods of measurement of gas:

"All meters necessary for the Measurement of Gas under this contract shall be furnished by the buyer and shall be either or at the option of the buyer and gas measurement by same shall be corrected to a basis of oz. pressure. It is agreed that should the meter, for any reason, fail to work and fail to register the amount of gas to the buyer, then the amount to be paid by the buyer during such time as the meters shall fail to register, shall be the average per day for the last preceding calendar month for which an accurate meter reading was had, multiplied by the number of days during which the meter failed to register. In case any question arises as to the accuracy of the meter measurement at any time, the meter shall be tested by either party, and the party demanding the test shall pay the expense of such test. No corrections for meter measurements are to be made dating back to the last test prior to date of complaint."

"The buyer shall at his own expense install and keep in repair meters of standard type sufficient in size to measure the number of cubic feet of gas received by him under this agreement, together with said meters to be installed on the above described property. The said meters shall be read daily in accordance with rules, methods and instructions of the Metric Metal Works or other standard forms for correct reading of such meters and the amount of gas so metered shall be computed on the basis of ounces to

a square inch above atmosphere. The seller shall have at all times, the right to inspect such meters providing, however, the buyer shall be notified in time to be present when such test is made, if he so desires. And it is agreed that if, after such examination it shall be found that the meter or meters are correctly measuring or registering the said gas, then the expense of such examination and test shall be borne by the seller, but if it shall be found, after such examination, that the said meter or meters are in bad repair, or do not correctly measure or register the gas, then the party of the second part shall correct same at his own expense and pay expense of such examination."

Other contracts have been prepared which read as follows:

"The meters to be used in the Measurement of Gas shall be Orifice Meters and furnished by the buyer, and the amount of gas measured shall be reduced by calculations to oz. pressure above an assumed atmospheric pressure of 14.4 and the volume shall be expressed at a temperature of 60 deg. fahr."

Inasmuch as a contract is legally assumed to be a meeting of the minds of the parties making the contract, it is very essential that the contract shall contain sufficient data or description to eliminate a different interpretation or construction being placed upon the words by either of the parties.

On Pages 221 to 228 the subject of atmospheric pressure is explained in detail, and on Page 171 the minor deviations due to standard values used in the computation of formulas etc., are mentioned. In order that the parties of the contract shall have full knowledge of the basis of measurement, it is recommended that the subject of the Table of Hourly Orifice Coefficients to be used should be incorporated as well as a more definite phraseology regarding pressure base on which the gas shall be calculated, especially in those fields where the average atmospheric pressure varies appreciably below, or above 14.4 lb. per square inch.

On Pages 221 to 228 it is noted that the difference of atmospheric pressure produces a considerable effect upon the basis of measurement or upon the value of the coefficient used when different interpretations are placed upon the term "atmospheric pressure." In order that the same quantity of gas shall constitute a cubic foot as far as is practically possible, (which would exactly constitute the same cubic foot at all places) the use of absolute atmospheric pressure is recommended, an expression of a certain number of ounces above an assumed atmospheric pressure of 14.4. A cubic foot of gas at 10 oz. above the assumed atmospheric pressure of 14.4 or an absolute pressure of 15.025 pounds would contain exactly the same weight of gas at any place providing the chemical constituents of the gas were the same.

The Bureau of Mines has issued definite instruction in regard to pressure base and temperature base as follows.

ARTICLE 15* REVISED MAY 31, 1921.

"All gas subject to royalty shall be measured by meters approved by the supervisor and installed at the expense of the lessee at such places as may be determined by the supervisor or his deputy. The standard of pressure in all measurements of gas sold or subject to royalty shall be 10 ounces above an atmospheric pressure of 14.4 pounds per square inch regardless of the atmospheric pressure at the point of measurement, and the standard of temperature shall be 60 deg. fahr. and all measurements of gas shall be reduced by computation to these standards no matter what may have been the pressure and temperature at which the gas was actually measured."

It is noted on Page 224 that if this is the intention of the party entering the agreement to use a base above an assumed pressure of 14.4 lb., no revision is required for the Coefficients.

* Plan for Conducting Work under Operating Regulations to Govern the Production of Oil and Gas. Under the Act of February 25, 1920.

During the past few years some companies have made their own orifice discs or have had them made at a nearby machine shop and have calculated Coefficients for the discs from data given in books of reference. In addition, many companies have prepared tables of Orifice Coefficients based upon an average mean curve of values of the "coefficient of velocity" which Coefficients deviate from those which have been published by the various manufacturers. For example, the Tables of Coefficients for $2\frac{1}{2}$ diameters upstream and 8 diameters downstream, as published in this book, were computed from a mean curve drawn through the plotted values of the coefficient of velocity as determined by experiment. This curve was plotted on a very large scale and the values of the coefficient of velocity were obtained from the curve by inspection. After several years work a formula was derived for a curve by using four points on the plotted curve, which very closely approximated the original curve. However, in some places the curve of the formula deviates from the plotted curve by approximately one-tenth of one per cent and therefore any Coefficients obtained by use of the formula will differ by one-tenth of one per cent from the Coefficients derived from the plotted curve. Even though the matter of even one-quarter of a per cent has no appreciable effect upon the price per thousand cubic feet of gas in preparing the contract, the mention of a certain published Table of Coefficients or a statement of the Coefficients to be used, incorporated as a part of the contract would eliminate the discussion or friction between the chart reading departments of the parties to the contract. It is obvious that, if one party was using a Table in which the Hourly Orifice Coefficient for a 4 x 2 orifice at 4 oz. pressure base, atmospheric pressure 14.4, base and flowing temperature 60 deg. fahr., specific gravity .6, was 2,019.4 and the other party used a Table where the Coefficient for the same orifice under the same conditions was 2,014.0 that there would be a difference at the rate of five

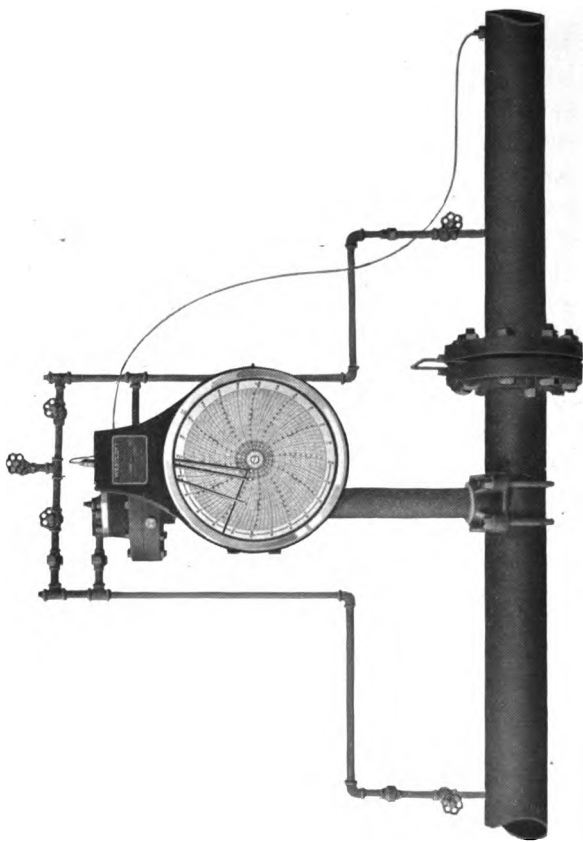

Fig. 87—DIFFERENTIAL, STATIC PRESSURE AND TEMPERATURE RECORDING GAUGE.
ALL RECORDS ON SAME CHART. SEE PAGE 132. Patent applied for.

dollars for each \$2000 worth of gas sold. It is also perfectly obvious that if the gas is being sold at 40 cents per thousand, the acceptance or rejection of the contract would never hinge on whether the rate should be 40 or 40.1 cents per thousand. However, after contracts have been made these variations in tables have been brought up by parties interested with consequent friction. The incorporation of either a reference to the Table to be used or the publication of a Table as a part of the contract would eliminate most of the friction which now exists relative to the use of Coefficients and methods of determination of volumes.

A clause of which the following is an example could be used.

“All meters necessary for measurement of gas under this contract shall be furnished by the buyer and shall be orifice meters. The gas measurement determined by same shall be revised to a pressure base of 8 oz. above an assumed atmospheric pressure of 14.4 lb. per square inch (absolute pressure 14.9 lb. per square inch). The basis of temperature for measurement shall be 60 deg. fahr. The values of the Coefficients used for orifices shall be those contained on Page . . . of the book “Measurement of Gases and Liquids by Orifice Meter,” published by the Metric Metal Works. The Coefficient shall be revised for changes in specific gravity of gas using multipliers in Table . . . in book above referred to. The specific gravity shall be determined by the method monthly or about the 25th of the month. Representatives of both parties shall be present at the test and their decision shall be the basis for calculation for the following month. revision to the Coefficient used shall be made on account of flowing temperature. The average temperature for each week shall be obtained by a recording thermometer. In case that there is no revision to the coefficient the word “no” is inserted and the second sentence relative to method obtaining temperature is omitted.

In the example given above the reference to this Hand Book may be replaced by reference to other published tables, or tables prepared and made a part of a contract.

An additional phrase in regard to Coefficients for various sizes of orifices not given in the above Tables, follows: Coefficients for orifices not given in the above Table shall be calculated from the formulae given on Page . . . from the book "Measurement of Gases and Liquids by Orifice Meter," and such values shall be used only after agreement by both parties.

MULTIPLE ORIFICE METER INSTALLATION

In cases where the flow of gas varies over very wide limits it may become necessary to install meters on parallel lines to accurately measure the minimum rate of flow.

Fig. 88 shows a layout for this purpose. When the rate of flow is small, the Regulator or Differential Gas Relief Valve prevents the gas from flowing through the secondary meter and thus all of the gas passes through and is measured by the primary meter. As the rate of flow through the primary meter increases, the differential pressure increases. When the differential pressure reaches a certain pre-determined amount which is slightly less than the maximum range of the primary differential gauge, the differential pressure which also acts on the regulator, causes the regulator to open the valve quickly and permit the increased quantity of gas to flow through both lines and be measured by two meters, both meters being in operation when larger quantities of gas are flowing. When the gas volume decreases the differential pressure at each orifice meter decreases and when it has reached a certain minimum which is insufficient to create a fair differential reading on both of the charts the Differential Relief Valve closes and causes all of the gas to pass through the primary meter.

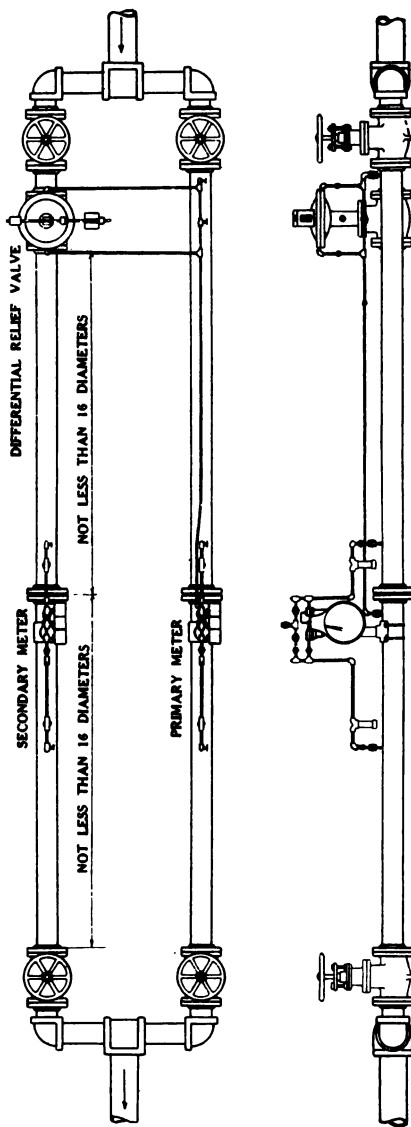

Fig. 88—MULTIPLE ORIFICE METER INSTALLATION

MEASUREMENT OF GAS AND AIR

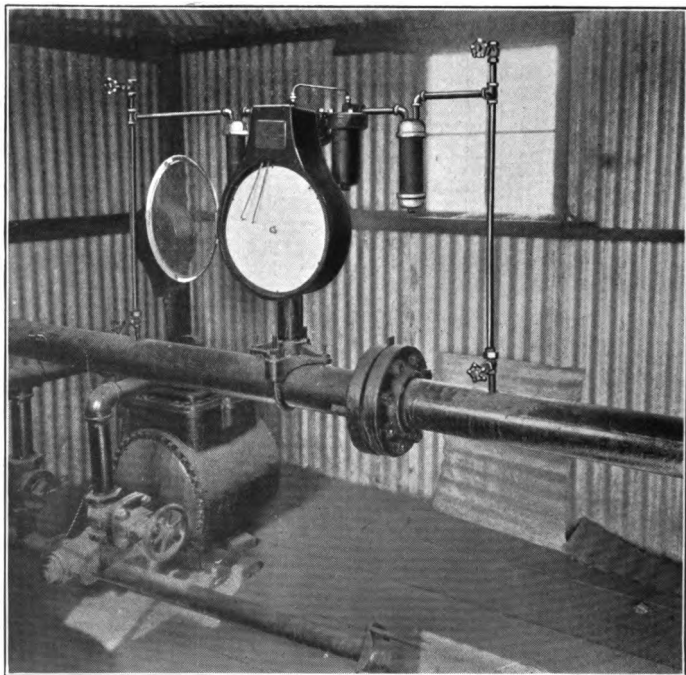

Fig. 80

INSTALLING GAS OR AIR METERS

The location of taps in the main line, for pressure connections between the pipe line and the Differential Gauge are dependent upon the Hourly Orifice Coefficients which are used, and vice versa.

Connections $2\frac{1}{2}$ diameters upstream and 8 diameters downstream from the orifice are Full Flow Connections. The stream flow occupies the full section of the pipe at the taps and is not restricted in area which is the case for all points closer to the orifice. See Fig. 90. Flange Connections are also used for gas, air, and water measurement.

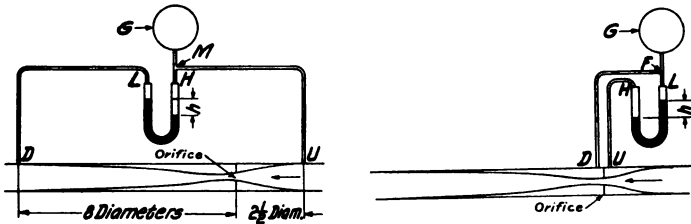

Fig. 90—FULL FLOW CONNECTIONS Fig. 91—FLANGE CONNECTIONS
 SKETCHES OF ORIFICE METER INSTALLATIONS. CURVED
 LINES ARE LINES OF STREAM FLOW

When Full Flow Connections are used as in Fig. 90, the static pressure recorded at G is the pressure at U. For Flange Connections the line pressure at D is recorded on the chart. See Fig. 91.

When Gauges are received with the Static Pressure Spring connected with the upstream pressure portion of the Differential Gauge, no change is required when used with Full Flow Connections. However, when Flange Connections are used the Static Pressure Spring must be connected to the downstream portion of the Differential Gauge. In this case remove the stuffing box at M (at the end of the flexible steel tubing) from the high pressure side of the gauge and attach it to the low pressure portion at tap F. The tubing is flexible and may be bent in any position.

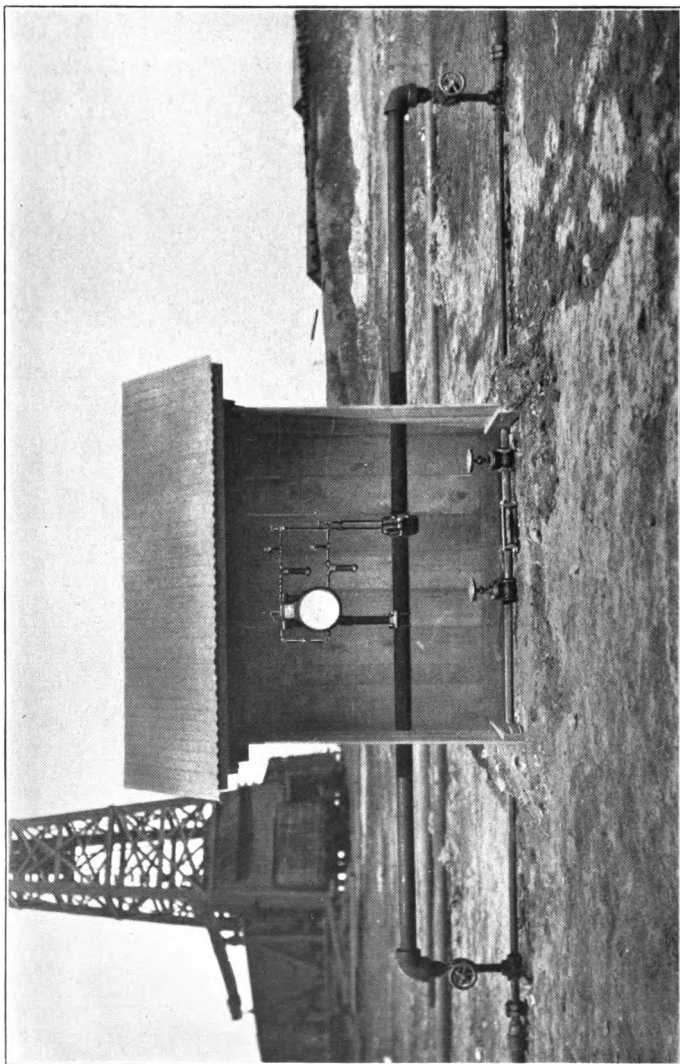

Fig. 92.

Orifice Meter Installation For Measuring Gases

Install the meter as far as possible from compressors, pumps or regulators. It is impossible to accurately measure any gas or liquid subject to violent pulsation.

The installation should be made with a level section of pipe on each side of the orifice, using a straight run of pipe of the same diameter without any fittings of any description within a distance of 16 diameters of pipe in either direction from the orifice.

When installing in a gas line place one gate valve at a distance of 16 diameters or greater upstream from the orifice and another gate valve at the same distance downstream. Gas must be dry to obtain proper measurement. Use drips at all low points in the line to remove condensates.

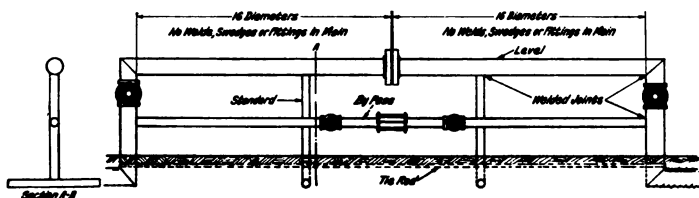

Fig. 95—AN INSTALLATION USED IN THE OSAGE INDIAN RESERVATION. SEE PAGE 164

The minimum distances of 16 diameters mentioned, apply for all locations where it is possible to obtain this distance on each side of the orifice without any valves or elbows. Distances less than these have been used satisfactorily and it is quite possible to reduce this distance, although no definite rule can be given as to the effect that different combinations of fittings at each location will produce.

It is possible to test out orifice installations in which shorter lengths of straight pipe have been used on each side

of the orifice. This is accomplished by drilling 3 one-quarter inch holes in the pipe at $2\frac{1}{2}$ diameters upstream, one hole in the top of the pipe and one on each side of the pipe where the upstream section is less than 16 diameters in length. In case the downstream section is less than 16 diameters in length, the three holes should be drilled at 8 diameters from the orifice, one on top and one on each side of the pipe. If the stream line flow through the orifice converges and diverges uniformly, the pressure at any two of the three taps upstream or downstream should be the same. If there is any appreciable difference in the pressures at either set of taps it is evident that the stream line flow is not concentric with the pipe. In order to make a simple test, connect one column of a U tube to the tap in top of the pipe, and the other column to one of the taps in the side of the pipe. When the normal rate of flow exists through the orifice, the difference in the heads of the water in the two columns of the U tube should not be more than one-quarter of an inch. If more than this, it is evident that the flow of the gas is influenced by some condition other than the orifice.

The stream line flow through the orifice will be the same irrespective of where the pressure taps are made. It does not make any difference whether they are made at the pipe connections, at the flanges or at other intermediate points. Any condition which will affect the stream line flow other than the orifice will affect the differential readings.

A by-pass for the main line should be installed, connecting the main line ahead of the inlet valve and the main line beyond the outlet valve, around the meter layout.

The size of pipe for the by-pass should be one half of the diameter of the main or greater and contain one valve, or two valves with a sleeve between them. In the latter case when the valves are closed the sleeve can be left open and thus prevent the flow of any gas through the by-pass.



Fig. 94.—ORIFICE METER BODY AND 50 INCH DIFFERENTIAL GAUGE INSTALLATION. PIPE TAP CONNECTIONS

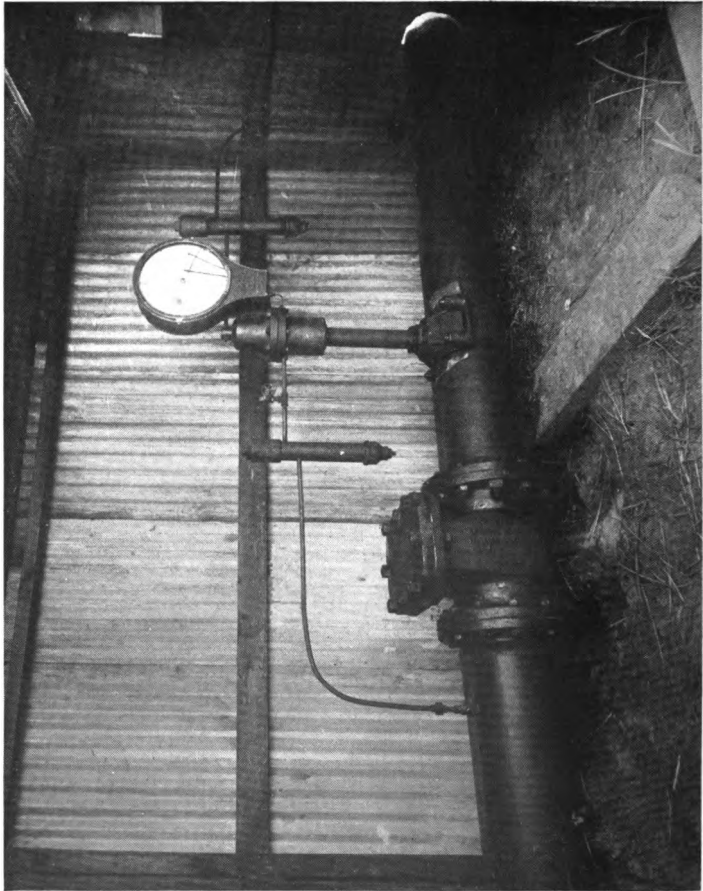

Fig. 96—ONE OF THE FIRST INSTALLATIONS OF ORIFICE METER BODY AND 50 INCH DIFFERENTIAL GAUGE
 $\frac{3}{4}$ and 8 Diameter Connections

Orifice Meter Body

Set the meter level in the line with the inlet and outlet lines connected to the correct end of the meter casting.

Leave space under the body so that the drain plug can be removed whenever desired.

Use oil on the thread of the orifice disc before screwing into place. Screw disc tight but without using force.

Orifice Meter Flanges

Set up the Flanges so that the jack screws are level with each other. Flanges tapped for pressure connections should be set with the taps vertical.

Place orifice disc with bevelled edge downstream.

Use a gasket on each side of the orifice disc. These gaskets should contain openings as large as the pipe and should be shellaced on the pipe flanges. Do not use shellac on the face of the gaskets next to the orifice plate, white lead is preferable.

Gauge Line Connections or Taps For Full Flow or Pipe Connections

(2½ Diameters Upstream and 8 Diameters Downstream).
See Pages 251 to 254.

Tap the pipe line at U, 2½ diameters upstream, and at D 8 diameters downstream from the orifice for ¼ inch pipe connections to the differential gauge. Larger connections may be used.

Tap above the center of the pipe, so that any condensate accumulating in the connections will drain into the main.

The openings must be tapped clean and perpendicular to the pipe line. After the nipples have been screwed in, examine the interior of the pipe to be sure that there are no burrs or that the nipple does not extend into the pipe. All burrs, chips, etc., should be removed. The inside of the pipe should have a smooth surface at the tap, otherwise the differential reading may be affected.

Instead of making taps in the pipe line for the connections if possible weld a short length of $\frac{1}{4}$ inch pipe to the main at points **U** and **D** then drill the pipe with a small drill passing through the nipple. This will avoid the possibility of any large projections in the pipe.

Taps $2\frac{1}{2}$ diameters upstream and 8 diameters downstream from the face of the orifice, are 10 inches upstream and 32 inches downstream for a 4 inch pipe.

Screw two $\frac{1}{4}$ inch pipe plugs in taps in flanges, if flanges contain taps.

Gauge Line Connections or Taps For Flange Connections

See Pages 252 to 254.

Flanges furnished for Orifice Meters contain holes tapped for $\frac{1}{4}$ inch pipe.

Hourly Orifice Coefficients for Flange Connections are not the same as for Full Flow Connections ($2\frac{1}{2}$ diameters upstream and 8 diameters downstream).

Orifice Meter for Coke Oven Gas

In an installation for measuring Coke Oven Gas, place the orifice disc (with the small hole in the disc below the orifice) between Steam Jacketed Flanges, so that the meter can be kept heated. Any tar which is deposited on the orifice plate will be kept in a fluid state and will run off, leaving a thin skim which will prevent the orifice plate from being oxidized by the action of the ammonium sulphates contained in the gas. The tar, which is deposited on the upstream side of the orifice, is drained, by the small opening in the orifice plate, into the downstream side, where it may be drained off by a drip placed in the line. The tar will form a seal for the small hole in the plate. All other instructions are identical with those for measuring gas.

**INSTALLING THE RECORDING DIFFERENTIAL AND
STATIC PRESSURE GAUGE**

For Measuring Gas or Air

- 100 inch Gauge and Orifice Meter Body. Page 251.
- 50 inch Gauge and Orifice Meter Body. Page 251.
- 50 inch Gauge, Full Flow Connections. Page 252.
- 50 inch Gauge, Flange Connections. Page 252.
- 10 inch or 20 inch Gauge, Full Flow Connections. Page 253.
- 10 inch or 20 inch Gauge, Flange Connections. Page 253.
- 50 inch or 100 inch Gauge, Full Flow Connections. Page 254.
- 50 inch or 100 inch Gauge, Flange Connections. Page 254.

These instructions apply to any of the diagrams above mentioned. See Pages 251 to 254.

Setting up Gauge—Install the gauge on a 2 inch pipe support, attached to the line or on a solid foundation. It may be attached directly to a solid post or placed on a shelf. The gauge must be set level and rigid so that it will not be affected by any excessive vibration.

Differential Pen Arm—Remove the plate (on which the number plate is fastened) and attach the differential pen arm in accordance with the instructions pasted on face of chart.

Glass—Remove the glass face from box of charts and attach to frame underneath the wire clips.

Adding Mercury—Remove the plug with rod from the funnel in the top casting and pour in the mercury, which is shipped in a pipe container. The plug with the rod attached is used only in shipping the gauge.

Add mercury until the differential pen rests at zero. The float should rise about one-eighth inch above the bottom of the low pressure chamber. When the pen rests at zero insert a small rod through the funnel opening, touch the float and be sure that it is floating and not resting on the bottom of the chamber. The funnel is closed with the one-eighth inch plug shipped with the gauge.

Static Pressure Connections—On account of the variable conditions under which meters and gauges are installed, it is impossible to present layouts which will meet all requirements. However, the instructions and layouts indicating the relative location of test connections **V** and **P**, and valves should be strictly followed.

Connect the tap in gauge at **H** with the tap **U** in the line, and tap **L** in the gauge with tap **D** in the line, with $\frac{1}{4}$ inch pipe. Larger pipe and fittings may be used.

Insert valves in the connecting lines just above the taps in the main with unions above the valves.

Drips may be installed in gauge lines for the purpose of collecting moisture and acting as partial shock absorbers. They are generally omitted.

Always give the lines a slight slant from the gauge toward the main and avoid any traps. Place valves and fittings in the same relation to each other as shown in diagram.

Supplementary valves **W** and **X** may be placed near the gauge if the gauge is located some distance from the line. Place them between the pipe line taps **U** and **D**, and the test or by-pass connections, never between the gauge and any test or by-pass connection.

By-Pass—It is desirable to install a by-pass as shown, placing valves at **Y** and **Z** and plug or valve at **K**.

Removing Chart—To remove the chart, raise the pens from chart with the pen lifter and remove the knurled thumb-nut in the center. The metallic dial can be taken off by twisting it slightly to the left after the four holding screws have been loosened. (Do not take them out).

Clock—The clock should be wound with the key furnished with the instrument. The movement is carefully timed before leaving the factory; however, if it should be necessary to regulate it, remove the dial and cover of clock box, and shift the small regulating lever in the proper direction. Clock movements are usually wound each day but will run for two days.

Placing Chart—Keep the pens from resting on dial by means of pen lifter and slip on a chart without touching the pens. Set the chart so that the pens will point to the particular hour of the day desired and secure in place with the knurled thumb-nut.

Pens and Ink—Fill the V shaped pens with ink using the ink dropper. Do not fill the pen more than two-thirds full and see that the ink flows when the pen touches the chart. Use **black*** ink in the lower or static pressure marking pen and **red** ink in the upper or differential pressure marking pen. Use the special ink only. Clean the pens frequently using a moistened edge or piece of blotting paper. To protect the pens the chart should be kept on the instrument whether in operation or not. Pens should rest at zero before turning gas or air into the meter and gauge. Be sure that the pen bears lightly on the chart, enough to make a clear line, but not so hard as to impair its sensitiveness. Do not bend the pens up or down but let them incline as received if they follow the arc. The ink will rise, due to capillary attraction.

Turning on Gas or Air.

Close **K**

Open **Y** and **Z**

Then open **W** and **X**

After the pressure is equalized in both portions of the gauge

Close **Y** and **Z**

Open **K**

Leaks—Be sure that valves **Y** and **Z** do not leak. Test all connections with soap suds and stop all leaks. Look after valve stems especially.

Orifice Capacity—After gauge is in operation, if the differential pen records near the maximum reading, change the orifice for one of a larger size. If this is not possible and it is found that the flow of gas keeps the marking arm

* Blue or green ink may be used.

at or above the maximum differential circle, it will be necessary to use a larger size of line and orifice flanges or meter casting in order to use a larger size of orifice, or use a differential gauge with a higher range of differential.

If, after twenty-four hours, the differential reading ranges at or below 10 per cent of the maximum range of the chart in inches, change the orifice for one of a smaller size or use a differential gauge with a smaller maximum range. Temporarily the gas may show an abnormally high static and differential pressure until the flow becomes settled.

For tables of different sizes of orifices required for measuring gas and air, see Pages 214 to 217.

Vibrating Differential Pen Arm—The hole in the bottom of the mercury pot of gauges, Figs. 97, 98, and 99, is $\frac{3}{8}$ inch in diameter. When the gas measured shows a pulsation which affects the differential pen arm marking on the chart, decrease the size of the opening in the mercury pot by screwing in one of the two bushings shipped with the gauge. For severe vibration use the bushing having a $\frac{1}{16}$ inch hole. For slight vibration use the bushing having a $\frac{1}{8}$ inch hole. In testing gauges for accuracy when a small hole bushing is used, allow extra time for the mercury to reach its level before reading chart. The bushing furnished for the U type of gauges is screwed in the upper end of the $\frac{1}{8}$ inch pipe where it enters the low pressure chamber. In gauges, Figs. 100 and 109, the vibration is lessened by reducing the opening in the rubber gasket, (which is placed between the bottom casting and the ring forming the division between the high and low mercury chamber), with a small wooden wedge.

If the static pressure pen arm vibrates regularly and rapidly install the meter farther from the source of the pulsation. Never partially close the valves **W** or **X** when in operation. See Pulsating Flow, Page 143.

MEASUREMENT OF GAS AND AIR

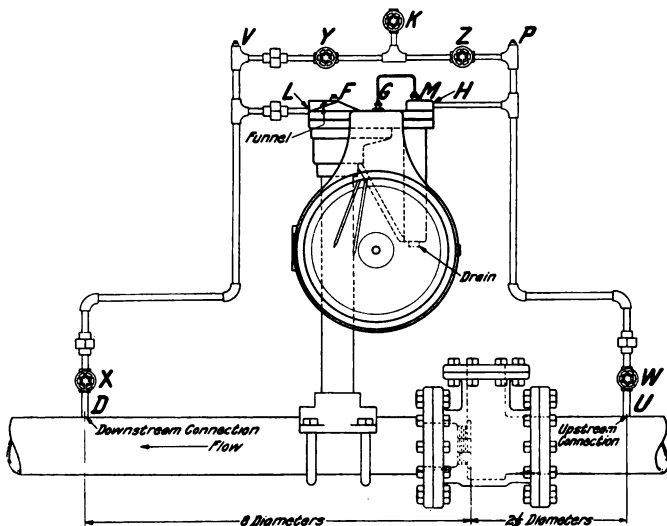

Fig. 96—ORIFICE METER BODY AND 60 OR 100 INCH GAUGE INSTALLATION FOR MEASURING GAS OR AIR

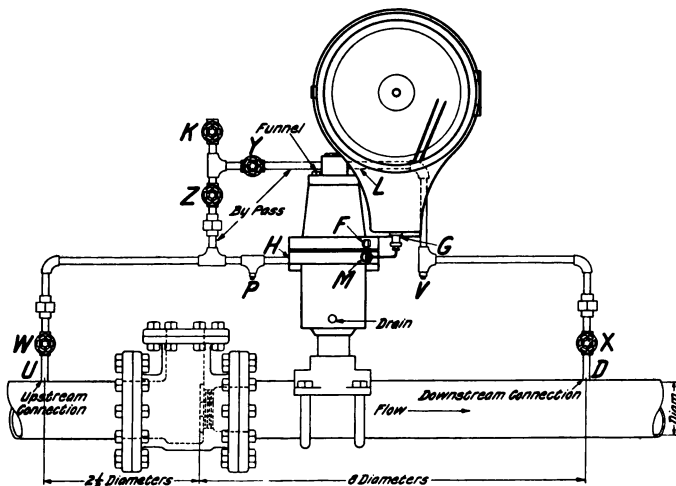

Fig. 97—ORIFICE METER BODY AND 50 INCH GAUGE INSTALLATION FOR MEASURING GAS OR AIR

MEASUREMENT OF GAS AND AIR

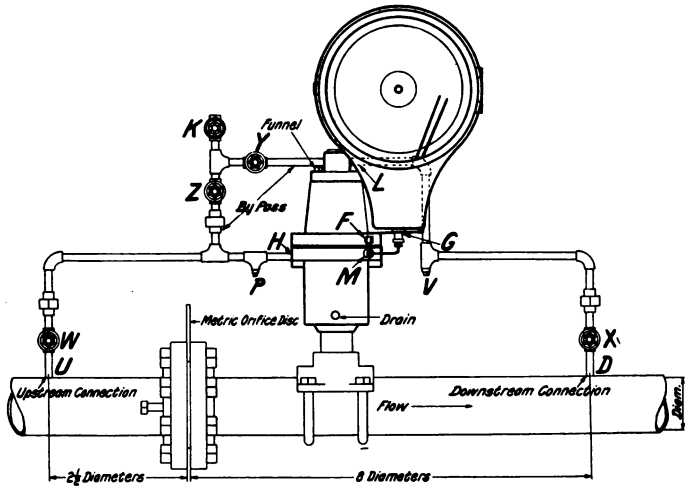

Fig. 98—50 INCH GAUGE INSTALLATION FOR MEASURING GAS OR AIR, FULL FLOW CONNECTIONS

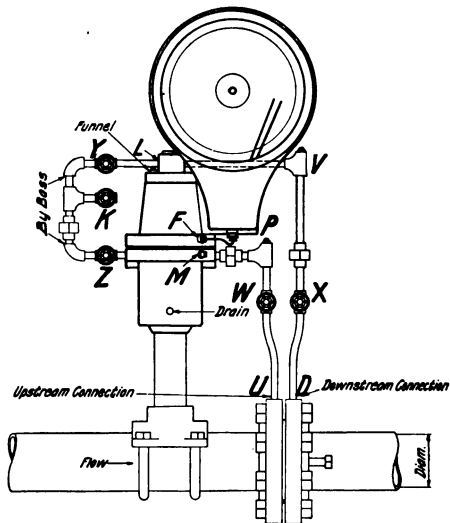

Fig. 99—50 INCH GAUGE INSTALLATION FOR MEASURING GAS OR AIR, FLANGE CONNECTIONS

MEASUREMENT OF GAS AND AIR

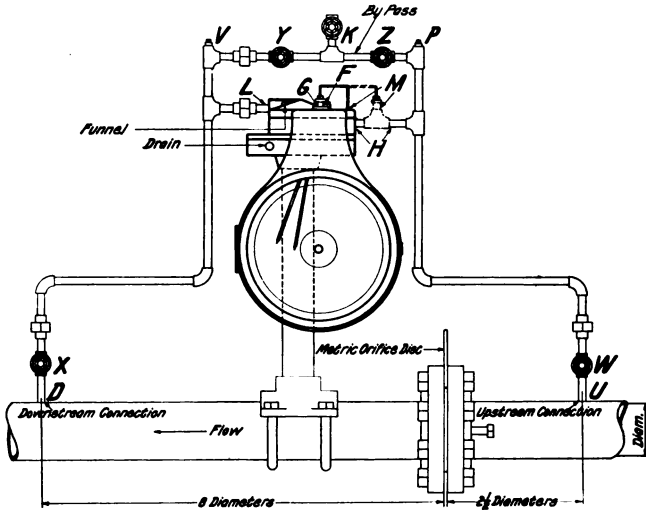

Fig. 100—10 OR 20 INCH GAUGE INSTALLATION FOR MEASURING GAS OR AIR, FULL FLOW CONNECTIONS

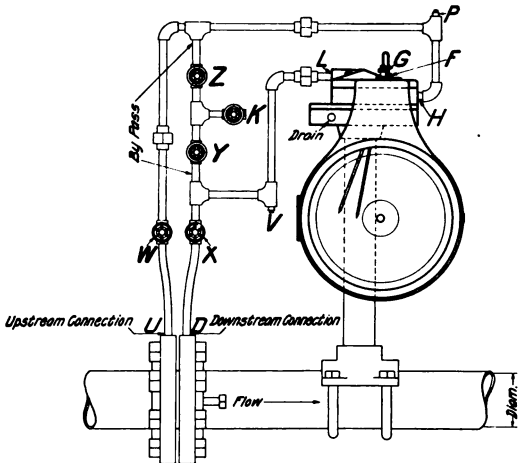

Fig. 101—10 OR 20 INCH GAUGE INSTALLATION FOR MEASURING GAS OR AIR, FLANGE CONNECTIONS

MEASUREMENT OF GAS AND AIR

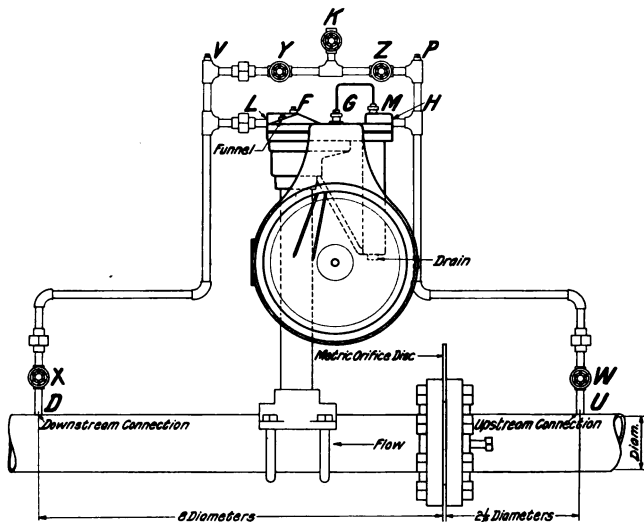

Fig. 102—50 OR 100 INCH GAUGE INSTALLATION FOR MEASURING GAS OR AIR, FULL FLOW CONNECTIONS

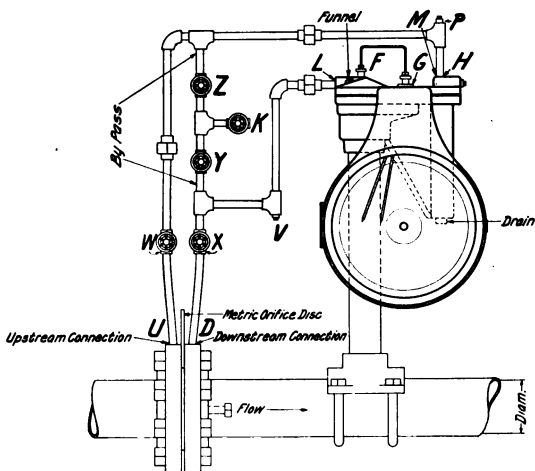

Fig. 103—50 OR 100 INCH GAUGE INSTALLATION FOR MEASURING GAS OR AIR, FLANGE CONNECTIONS

TESTING DIFFERENTIAL GAUGES

For Measuring Gas or Air

Gauges should be checked daily or weekly by turning off the gas to see if the marking arms rest at zero.

Checking Gauge for Zero:—

Close **K**

Open **Y** and **Z**

Close **W** and **X**

The differential pen arm should return to zero.

Open **K** slowly and allow the gas or air to escape slowly into the atmosphere, thus making sure that there is no pressure on either portion of the gauge.

The static pressure pen arm should return to zero.

There will be a slight difference between the zero position of the differential pen arm when the gauge is under pressure and not under pressure. This difference is created by the expansion of the metal under pressure. The arm should be checked for zero under working pressure conditions. The difference between the zero position under working pressure and not under pressure should be noted and this constant difference should be maintained when checked with the test gauge.

The differential pen arm should be kept in practically a straight line at the flexible joint. The differential pen arm can be adjusted to zero by a small movement of the pen arm at the flexible joint, or at the connection with the shaft. When the pen rests at zero determine if the float is floating and not resting on the bottom of the mercury pot.

Partially close **Y**

Open **X** carefully when the differential pen should recede one-fourth inch or more (actual measurement) below the zero line. If the float rests on the zero bottom of the chamber add mercury. See paragraph Adding Mercury, Page 247.

After test close **X**, open **Y**.

Checking Differential Gauge on Pressure Lines—

Close **K**

Open **Y** and **Z**

Close **W** and **X**

Open **K**

Remove plugs at **P** and **V**

Attach test gauge by suitable connections at **P**

Close **Y**, Be sure **Z** is open

Open valve **W** slightly when a pressure will be exerted on mercury in the high pressure portion of the gauge, and on the test gauge.

By partially opening or closing valve **Z**, the pen arm can be stopped at any point on the chart and checked with the reading on the test gauge.

After tests remove the test gauge and replace plugs **P** and **V**.

Proceed as for **Turning on Gas**, Page 249..

Checking Differential Gauge on Vacuum Lines—

Close **K**

Open **Y** and **Z**

Close **W** and **X**

Open **K**

Remove plugs **V** and **P**

Attach test gauge by suitable connections at **V**

Close **Z**

Be sure **Y** is open

Open valve **X** slightly, when a vacuum will be formed in the low pressure portion of the gauge also on the test gauge.

By partially opening and closing valve **Y** the pen can be stopped at any point desired and reading checked with the test gauge.

After tests remove the test gauge and replace plugs **P** and **V**.

Proceed as for **Turning on Gas**, Page 249.

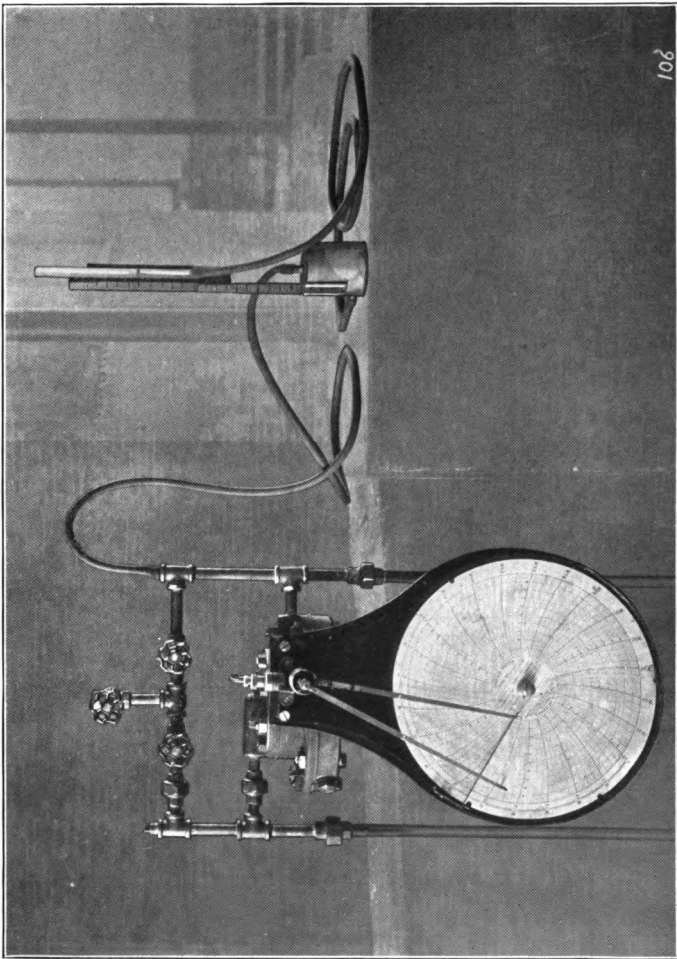

Fig. 104—TESTING A 10 INCH DIFFERENTIAL GAUGE

Checking Differential Gauge under Working Pressure—If the glass tubes of the test gauge are of sufficient strength to hold the pressure, and the scale is of equal range with the chart in inches of water, the recording differential gauge may be checked with a test gauge by connecting one column of test gauge with tap at **P** and the other column with the tap at **V**.

Close **K**

Open **Y** and **Z**

Then open **W** and **X**

By partially opening and closing valve **Y** the reading can be checked with the test gauge. It can be left as a permanent installation for checking the recorded differential reading of the pen.

Adjustment—If the zero position of the differential pen is O. K. and the higher readings of the differential pen on the chart do not check with the test gauge, make adjustment by increasing the length of the float lever arm when the reading is fast, and decreasing when slow. This is accomplished by moving the lock nuts **NN** (shown in Figs. 105 and 106) in the proper direction.

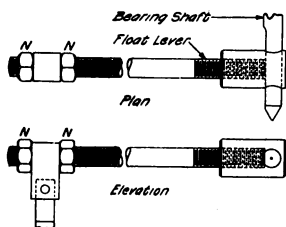

Fig. 105.

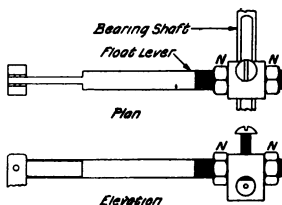

Fig. 106.

Testing Static Spring—To test static spring attach the test gauge at **G** and check the two gauges. The use of an inspector's test gauge is recommended rather than the use of a portable dead weight tester. The inspector's test gauge

should be accurately calibrated against a mercury column at proper intervals to be sure that it is accurate and that the spring has not lost its elasticity. Dead weight testers under ideal conditions give satisfactory results but it is very difficult to obtain these conditions especially in the field.

General—Before turning the gas into the gauge always be sure that valves **Y** and **Z** are open before opening valves **W** and **X** or either valve **W** or **X**. This precaution will eliminate practically all damage to differential pen arm.

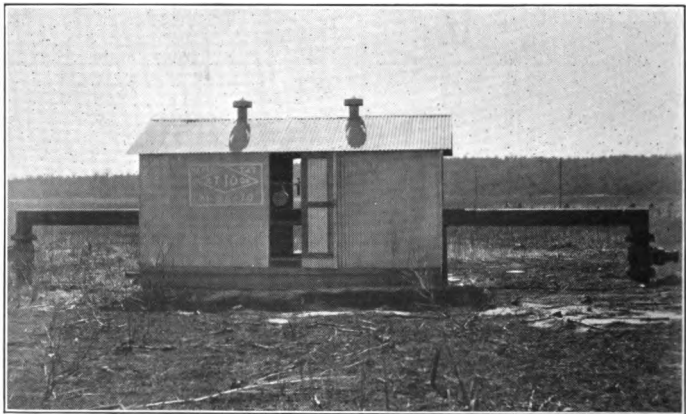

Fig. 108

READING CHARTS

The formula for use in measuring gas or air with the orifice meter is

$$\text{Quantity} = C\sqrt{h \times (A \pm p)}.$$

C = Coefficient obtained from Table of Coefficients or calculated for the proper size of orifice, diameter of pipe, Pressure Base, Base and Flowing Temperature, and Specific Gravity.

h = differential pressure in inches of water.

A = atmospheric pressure in lb. per square inch.

p = static pressure expressed in lb. per square inch, plus when above atmospheric pressure, minus when below atmospheric pressure. The gauge pressure above atmosphere is usually expressed in pounds per square inch so that no change of units is required. However, vacuum is indicated in inches of mercury vacuum below atmospheric pressure. To use this value in the formula it must be converted into pounds per square inch below atmospheric pressure. The vacuum in pounds per square inch, below atmospheric pressure, is equal to the vacuum gauge reading in inches of mercury multiplied by 0.4908; for example, 20 inches mercury vacuum is equal to 9.82 lb. per sq. in. below atmospheric pressure ($20 \times .4908 = 9.82$).

To simplify all calculations, Tables of Pressure Extensions have been published which give the results of the formula $\sqrt{h \times (14.4 \pm p)}$, in figures for various combinations of pressure and differential readings from 29 inches vacuum to 500 lb. pressure and from 1 inch to 100 inches differential. This eliminates the necessity of figuring out the formula for each reading in determining the volume of gas passing the meter. In this formula, the atmospheric pressure is assumed as 14.4 lb. If the atmospheric pressure varies ap-

MEASUREMENT OF GAS AND AIR

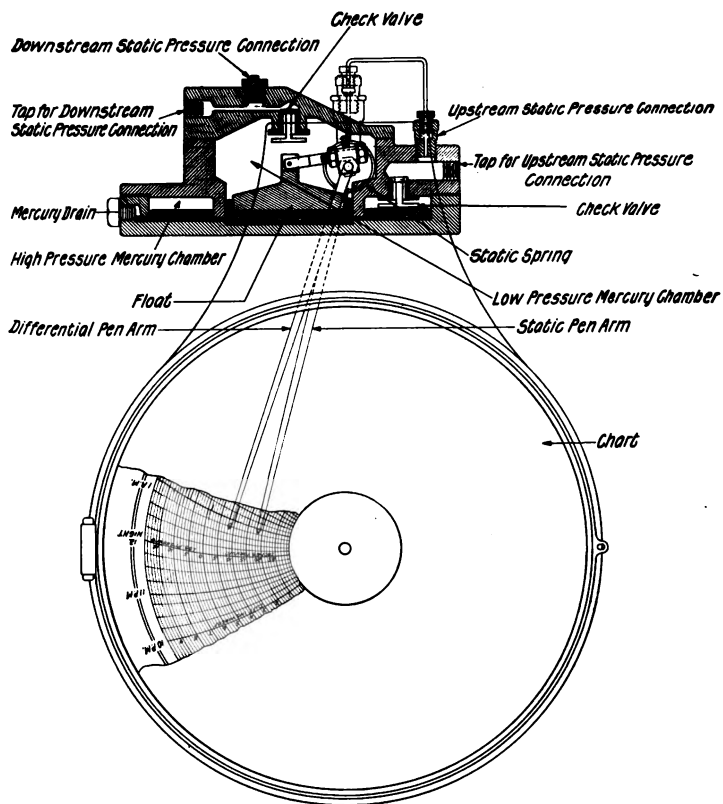

Fig. 109—10 INCH DIFFERENTIAL GAUGE. SECTIONAL VIEW

preciably from 14.4 lb., adjustment must be made to the static pen arm, or to the static pressure readings as explained on Pages 221 to 228.

To obtain the quantity passing the meter, average the differential pressure (marked in red ink) and the static pressure (marked in black ink*) on the chart for each hour. Obtain from the book of Pressure Extensions the extensions for the (differential and static) pressure readings for each hour, add the extensions together and multiply the sum by the Hourly Orifice Coefficient for the orifice under the conditions being used. The result will be the volume of gas in cubic feet passing the meter for the period during which the pressures were averaged.

If the differential pressure varies over wide ranges during the hourly period, fifteen minute periods should be used. When fifteen minute periods are used the sum of the extensions should be divided by four before multiplying by the Hourly Orifice Coefficient.

On Page 265 is shown an orifice meter chart report and on Page 264 is an extract from a book of Pressure Extensions which apply to the chart shown on Page 264. To follow the work through in detail, the chart when obtained from the field, is examined to note whether any extraordinary conditions took place at the meter during the period. The differential pressure on the chart is averaged by inspection for each hour, and the average differential reading is noted opposite the differential record, in pencil on the chart. Beginning at 8 A. M. the average differential is $20\frac{1}{2}$ inches from 8 A. M. to 9 A. M. for the first hour; 22 inches from 9 A. M. to 10 A. M. and 22 inches from 10 A. M. to 11 A. M., etc., the numerical values being marked in the hourly period opposite the differential record. The static pressure is then averaged by inspection for each hour; being 30 lb. from 8 A. M. to 9 A. M., 31 lb. from 9 A. M. to 10 A. M.

*Blue or green ink may be used.

MEASUREMENT OF GAS AND AIR

PRESSURE EXTENSIONS

30-39 LB.

18.5 to 100 Inches of Water Differential Pressure

In. Diff. or H.	80	81	32	33	34	In. Diff. or H.	35	36	37	38	39	In. Diff. or H.
18.5	28 660	28 961	29 268	29 612	29 923	18.5	30 231	30 535	30 837	31 135	31 431	18.5
19.	29 045	29 370	29 692	30 010	30 325	19.	30 637	30 945	31 251	31 553	31 853	19.
.5	29 424	29 754	30 080	30 402	30 721	.5	31 037	31 350	31 659	31 966	32 269	.5
20.	29 799	30 133	30 463	30 790	31 113	20.	31 432	31 749	32 062	32 373	32 680	20.
.5	30 170	30 507	30 842	31 172	31 499	.5	31 823	32 144	32 461	32 775	33 086	.5
21	30 535	30 877	31 215	31 550	31 881	21	32 209	32 533	32 854	33 172	33 487	21
22	31 254	31 604	31 950	32 292	32 631	22	32 967	33 299	33 627	33 953	34 275	22
23	31 956	32 314	32 668	33 018	33 365	23	33 708	34 047	34 383	34 716	35 046	23
24	32 644	33 009	33 371	33 728	34 082	24	34 433	34 779	35 123	35 463	35 799	24
25	33 317	33 690	34 059	34 424	34 785	25	35 143	35 496	35 847	36 194	36 538	25

Fig. 110—EXTRACT OF "PRESSURE EXTENSIONS" APPLYING TO CHART (Fig. 111). (Size Reduced one-third)

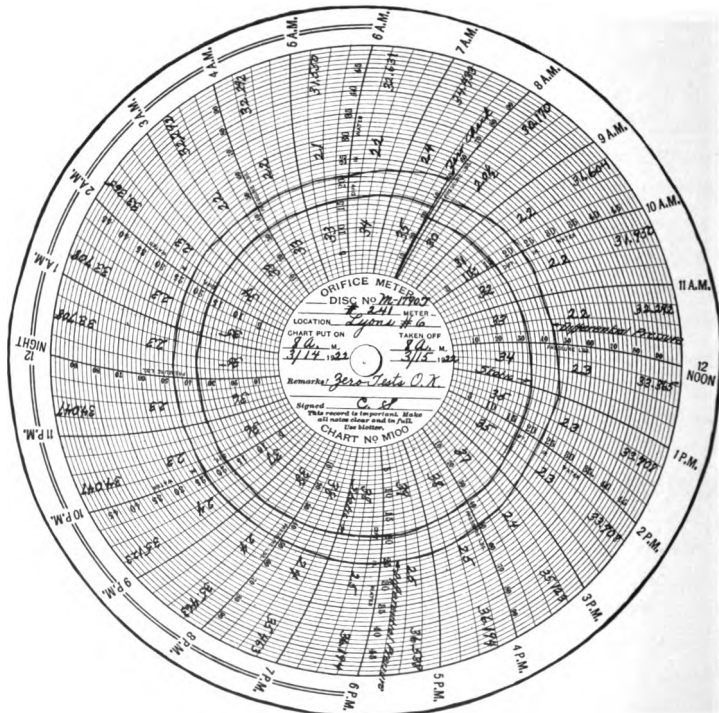

Fig. 111—ORIFICE METER CHART

MEASUREMENT OF GAS AND AIR

ORIFICE METER CHART REPORT

LOCATION—*Lyons No. 6.* DATE—*3-14-22.*
 Meter No. *241* Size *4x2* Orifice Coefficient *1184.7*

Time	Static Gauge Pressure	Differential Inches Water	Extension
8- 9 A. M.	30	20½	30.170
9-10 A. M.	31	22	31.604
10-11 A. M.	32	22	31.960
11-12 A. M.	33	22	32.292
12- 1 P. M.	34	23	33.365
1- 2 P. M.	35	23	33.703
2- 3 P. M.	35	23	33.708
3- 4 P. M.	37	24	35.123
4- 5 P. M.	38	25	36.194
5- 6 P. M.	39	25	36.538
6- 7 P. M.	38	25	36.194
7- 8 P. M.	38	24	35.463
8- 9 P. M.	38	24	35.463
9-10 P. M.	37	24	35.123
10-11 P. M.	36	23	34.047
11-12 P. M.	36	23	34.047
12- 1 A. M.	35	23	33.708
1- 2 A. M.	35	23	33.708
2- 3 A. M.	34	23	33.365
3- 4 A. M.	33	22	32.292
4- 5 A. M.	33	22	32.292
5- 6 A. M.	33	21	31.550
6- 7 A. M.	34	22	32.631
7- 8 A. M.	35	24	34.433

Total 808.97
 Coefficient 1184.7
 Delivery 958,387 cu. ft.

Fig. 112

and 32 lb. from 10 A. M. to 11 A. M., etc. The average reading for each hour being noted on the chart in the hourly period opposite the static pressure record. The extension obtained from the Table of Pressure Extensions, may be written on the outer margin of the chart as shown in Fig. 111. In case they are compiled on a report as on Page 265, all calculations are made on the report and the extensions are added and multiplied by the Coefficient of the disc which will give the delivery. In case the extensions are written on the outer margin of the chart, they are added on an adding machine, the sum is noted on back of the chart, where this sum is multiplied by the Coefficient giving the quantity passing for the day. Where the chart only is used all data is compiled on one record which eliminates the use of other forms and the charts for each meter can be assembled in a large envelope day by day with the extension, Coefficient, and daily quantity being noted on the face of the envelope as is shown in Fig. 114. One envelope is used for a month for each meter or location.

To reduce the work involved, some companies average the differential reading for the day and the static reading for the day. The pressure extension is obtained for the average readings and is multiplied by the number of hours for which the average was obtained. This product is then multiplied by the Hourly Orifice Coefficient. The average differential for the chart shown on Page 264 is 23 inches. The average pressure is 35 lb. The extension of these average values is 33.708, which multiplied by 24 equals the total of the pressure extensions for the day. ($24 \times 33.708 = 808.99$). It will be noted that this result is slightly greater than that derived by obtaining the extension for each hour and adding. Where the differential and static pressure records do not vary over wide ranges this method will give results which will check very closely with the previous method. However, these results will invariably be higher.

In case the differential and static pressures vary over wide ranges, this method is not satisfactory due to the fact that the results will be considerably higher than the true result. For very wide variations the charts should be averaged for fifteen minute periods and extensions for the fifteen minute periods should be made to obtain accurate results.

Quite frequently a planimeter and reference chart is used to obtain the average differential reading and average static reading. The results obtained by this method are as accurate as those obtained by averaging the differential and static pressure records for the day and then obtaining the average extension, which extension is multiplied by the number of hours for which the average was obtained. This method eliminates the necessity of recording the differential and static pressures on the chart and greatly simplifies the work. It should only be used when the static pressures or differential pressures do not vary over wide limits, as the results in such cases will be greater than the true result.

If, for any reason, the meter is out of service for a period during which the gas has been flowing, the average reading for the period prior to shut down and after shut down should be used for the period of the shut down.

ORIFICE METER CALCULATOR

As has been previously explained, the best method of reading and calculating the charts for the determination of flow, is to obtain the pressure extension for each period and add these pressure extensions together and multiply by the coefficient. It has also been explained that the method of averaging the differential pressure for the day, the static pressure for the day, and using these averages for the calculation of the flow, will often produce a considerable error if the static or differential pressures vary over a wide range during the day. The use of the planimeter or averaging instrument is also open to the same objection and does not

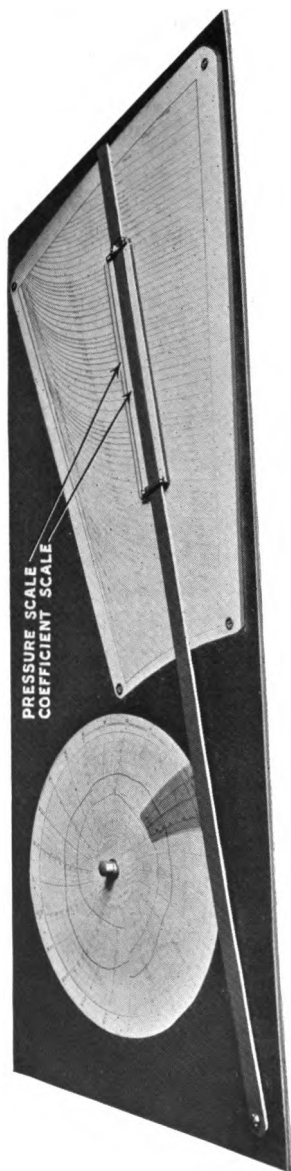

Fig. 113—ORIFICE METER CALCULATOR.

TO USE THIS CALCULATOR, ONLY THE COEFFICIENT IS NECESSARY. NO PRESSURE EXTENSIONS ARE REQUIRED. READINGS ARE EXPRESSED IN CUBIC FEET OF GAS PER HOUR, BARRELS OF OIL PER HOUR OR POUNDS OF STEAM PER HOUR. ON A MONTH'S READINGS THE ERROR WILL BE LESS THAN ONE-FIFTH OF ONE PER CENT. IN PREVIOUS METHODS THE ERROR IS VARIABLE AND DEPENDS UPON METHODS USED.

Patent applied for.

in any way increase the accuracy but will produce about the same accuracy. To simplify all work and obtain an instantaneous value of the flow for each hour, or smaller period if desired, a calculator has been placed on the market.

By using this instrument the operator can place the chart in proper position on the instrument and determine the flow for any hour during the day without any calculations whatever. That is:—the instrument adds 14.4 to the static reading and multiplies the square root of this value by the square root of the differential by the coefficient of the disc at one setting giving the hourly flow.

The operation of the instrument is as follows: The chart is placed on the instrument, the sliding scale is moved so that the value of the coefficient is opposite the indicating mark on the lever, and without any further alteration for each chart the lever is moved until the hair line on the transparent indicator is over the average differential reading. The operator then reads the hourly flow opposite the static pressure on the scale. This hourly flow is registered on an adding machine. The chart is moved one hour ahead, lever moved so that the indicator is over the differential reading for the following hour, he looks opposite the static pressure for that hour on the scale and obtains the reading which is placed on the adding machine. For the third hour, the lever is moved until the indicator is over the differential reading for the third hour and opposite the static pressure, he obtains the reading on the diagram and adds this value on the adding machine, etc. At the end of the 24 hour period the total result is added and the volume per day is read from the adding machine. This eliminates any extended calculations, eliminates the necessity of the operator reading the differential pressure and carrying these readings in his mind and obtaining the extension from an extension book. In fact all laborious work involved in calculating orifice meter charts is eliminated.

MEASUREMENT OF GAS AND AIR

LOCATION—*Lyons No. 6.*

Meter No. *241* Orifice No. *M1790T* Month—*March, 1922*
 Internal Diameter of Pipe *4.026"* Diameter Orifice *2"*
 Pressures at $2\frac{1}{2}$ and 8 Diameter Connections.
 Atmospheric Pressure *14.4.* Temperature *60 deg. fahr.*
 Pressure Base *10 oz.* Coefficient, *1261.3* Specific Gravity *.60.*
 Remarks—*Gas Tested 3-10-'21.* *Specific Gravity, 0.68*
1261.3 x .9393 = 1184.7 Revised Coefficient used after 10th.

Date	Pressure Extension	Coeffi- cient	Quantity	Remarks
1	774.97	1261.3	977470.	
2	752.31	"	948889.	
3	736.94	"	929502.	
4	715.23	"	902120.	
5	692.14	"	872996.	
6	676.33	"	853055.	
7	672.86	"	848678.	
8	663.54	"	836923.	
9	654.92	"	826051.	
10	643.41	"	811533.	
11	632.16	1184.7	748920.	
12	681.02	"	806804.	
13	762.45	"	903274.	
14	808.97	"	958387.	
15				
16				
17				
18				
19				
20				
21				
22				
23				
24				
25				
26				
27				
28				
29				
30				
31				

Fig. 114

PART FIVE

MEASUREMENT OF STEAM

An orifice meter will measure the flow of any gas, vapor or liquid of fairly uniform gravity at high pressure or under a vacuum. It is especially adaptable for the measurement of steam as the properties peculiar to steam simplify all calculations to a minimum. Being a weight measuring instrument as well as a volume instrument, as will be shown later, it becomes the nearest approach to a perfect flowing fluid weighing machine and steam power recording instrument. It automatically weighs the moisture in unsaturated steam and even though the amount of moisture or superheat in the steam is unknown, the power as determined is approximately correct for the reason that the correcting factors are very small for relatively large amounts of moisture and superheat.

The great advantage in using the type of meter which is used for measuring gas is that the operator obtains a definite continuous record of the pressure in the line as well as the flow. Flow meters do not give a pressure record on the same chart, this information must be obtained from an independent pressure gauge.

Furthermore, it is the consensus of opinion of engineers that the orifice will give more consistent results than can be obtained by the pitot tube or a modification, and the flow nozzle. The ease of installation of the plain orifice, as compared with the nozzle, has made a distinct appeal to the steam engineer.

For a description of the orifice meter the reader is referred to Part 3. This Part precedes the following details which apply to steam.

The Differential Gauge records on a chart the differential pressure between the pressure connections, and the static pressure at one of the connections. These factors with the area of the orifice enable us to determine the flow from the formula:

$$W = C \sqrt{h P}$$

Where W = the quantity of steam passing the orifice. The result can be expressed in "pounds" or "pounds from and at 212 deg. fahr."

C = the Hourly Orifice Coefficient for steam. The value of this term remains the same for each installation and basis of measurement.

h = the differential pressure existing between the two pressure connections expressed in inches of water head, this value being recorded graphically on the chart of the recording differential gauge.

P = the static pressure expressed in absolute units, being equal to the gauge pressure (which is recorded on the chart) plus the atmospheric pressure. The value of the gauge pressure is also recorded on the chart.

The value of the Hourly Orifice Coefficient C in the above formula is found on Pages 282 and 287, computed for various diameters of orifice and diameters of pipe, these values having been determined by exhaustive experimental and practical tests in comparison with actual displacement. The extensions of the values of \sqrt{hP} have been compiled and are given in the book entitled "Pressure Extensions" published by this Company.

MEASUREMENT OF STEAM

Example—One hour reading (weight desired):

Average differential reading $h=25$ inches.

Diam. of Pipe = 4 inches. Diam. of Orifice = 2 inches.

Average Gauge Pressure $p=90$ pounds.

Hourly Orifice Coefficient $C=48.19$ for 2 inch orifice in a 4 inch line, (Page 282).

$$\begin{aligned} \text{Weight per hour, } W &= 48.19 \sqrt{25 \times (90 + 14.4)} \\ &= 48.19 \times 51.088 = 2462 \text{ pounds.} \\ &\quad \begin{array}{cc} \text{Orifice} & \text{Pressure} \\ \text{Coefficient.} & \text{Extension.} \end{array} \end{aligned}$$

If the heat content or power is desired (using the same data with feed water temperature at 62 deg. fahr.) the Hourly Orifice Coefficient C is 57.55 for a 2 inch orifice in a 4 inch line, (Table 55, Page 287).

$$\begin{aligned} W &= 57.55 \sqrt{25 \times (90 + 14.4)} = 57.55 \times 51.088 \\ &\quad \begin{array}{cc} \text{Orifice} & \text{Pressure} \\ \text{Coefficient.} & \text{Extension.} \end{array} \end{aligned}$$

or the power passing through the orifice = 2940 "pounds from and at 212 deg. fahr." per hour.

Therefore, the Power flowing in the line is equal to the Coefficient of the Disc multiplied by the Pressure Extension.

The relation between the differential pressure and the velocity of the fluid through the orifice is expressed by the formula:

$$V = C_v \sqrt{2 gH}$$

Where V = velocity of flowing fluid in feet per second.

g = acceleration due to gravity in feet per sec., per sec. = 32.16.

H = differential expressed in feet head of flowing fluid.

The well known formula $V = \sqrt{2 gH}$ expresses the theoretical flow eliminating friction and other influences. When applied to actual conditions a multiplier is used to take care of the influences due to contraction of jet, friction,

etc. This factor C_v is commonly known as the "coefficient of velocity." This formula may be applied directly for measurement as in the following example.

Atmospheric Pressure 14.7. Line Pressure, 100 lb. Gauge. Diameter of Orifice, 3 inches. Diameter of Pipe, 6.065 inches. Differential, 2 inches of Mercury. Pressure Connections, $2\frac{1}{2}$ and 8 diameters from the orifice, no moisture in the steam.

$$\text{Ratio of diam. of orifice to diam. of pipe} = \frac{3.00}{6.065} = .495$$

$$C_v \text{ for } .495 \text{ ratio} = .734.$$

For the measurement of steam, the gauge connections to the gauge are filled with water as in measuring liquids and consequently each inch of mercury differential is offset by an inch of water so that 2 inches of mercury pressure as indicated is equal to $(2 \times 12.6 = 25.2)$ 25.2 inches of water differential.

As one cubic foot of steam at 100 lb. gauge pressure weighs 0.257 lb. per cu. ft. one foot head of water equals $\frac{62.35}{0.257}$ or 243 feet head of steam and one inch of water equals 20.25 feet of steam head at an absolute pressure of 14.7 lb. per square inch.

Therefore, $H = 20.25 \times 25.2$ or 510 feet head of steam.

Therefore, $V = C_v \sqrt{2gH} = .734 \sqrt{2 \times 32.16 \times 510} = 132.9$ ft. per second.

Area of the orifice = .0491 sq. ft. Page 75.

Quantity = area \times velocity = $.0491 \times 132.9 = 6.53$ cu. ft. per second.

Weight = volume in cubic feet \times weight per cubic foot = $6.53 \times 0.257 = 1.68$ lb. per second = 6050 lb. per hour.

M E A S U R E M E N T O F S T E A M

In the formula $V = C_v \sqrt{2 g H}$ the differential head is expressed in feet head of flowing fluid. As it is not practical to register this value directly, the differential is recorded on the chart in inches of water pressure. If steam is flowing in a line under a pressure of 100 pounds gauge, the weight of a cubic foot of steam is 0.257 lb. and as water weighs 62.35 lb. per cubic foot or 243 times as much, one foot of water pressure is equivalent to 243 feet head of steam at 100 lb. pressure; one inch of water pressure is equal to one-twelfth of 243 feet or 20.25 feet of steam head and 20 inches of water head would equal 20 times 20.25 feet or 405 feet head of steam at 100 pounds gauge. This relation may be expressed by the following formula:

$$H = \frac{w_w h}{12 w}$$

Where H = differential in feet head of flowing steam.

w_w = weight of water in pounds per cubic foot = 62.35.

h = differential in inches of water pressure.

12 = number of inches in a foot.

w = weight of flowing steam in pounds per cu. ft.

The above example can be written thus:

$$H = \frac{62.35 \times 20}{12 \times 0.257} = 405 \text{ feet steam head.}$$

Substituting the value of H in the formula $V = C_v \sqrt{2 g H}$

$$\text{We obtain } V = C_v \sqrt{\frac{2 g w_w h}{12 w}} = C_v \sqrt{\frac{2 \times 32.16 \times 62.35 h}{12 w}}$$

$$\text{or } V = 18.281 C_v \sqrt{\frac{h}{w}}$$

This expression forcibly illustrates the fact that the velocity depends upon the weight per cubic foot of the fluid. As the weight per cubic foot increases, the velocity decreases when the differential pressure is a constant.

Or using a plain illustration with the same force applied, a ball containing a cubic foot of lead will move with less speed or velocity than a ball containing the same quantity of wood.

The weight of steam passing the orifice per hour is equal to the area of the orifice in square feet multiplied by the velocity in feet per hour multiplied by the weight per cubic foot. This fact may be expressed by the following formula:

$$W_1 = \frac{0.7854 d^2}{144} \times 3600 V \times w$$

$$W_1 = 19.635 d^2 \times V \times w$$

Where W_1 = actual weight of steam passing the orifice in pounds per hour.

$$\frac{0.7854 d^2}{144} = \text{area of orifice in square feet.}$$

d = diameter of orifice in inches.

144 = number of square inches in a square foot.

3600 = seconds in one hour.

V = velocity of fluid through orifice in feet per sec.

Substituting the value of V where $V = 18.281 C_v \sqrt{\frac{h}{w}}$ in the expression, $W_1 = 19.635 d^2 \times V \times w$

$$W_1 = 19.635 d^2 \times 18.281 C_v \sqrt{\frac{h}{w}} \times w$$

$$W_1 = 358.95 C_v d^2 \sqrt{hw}$$

This expression is true for any gas, vapor or liquid.

When measuring steam with an Orifice Meter the connecting lines and the gauge itself would be partially filled with condensed water, which would create an erroneous differential reading if the head of water acting on the two

MEASUREMENT OF STEAM

Table 52—PROPERTIES OF SATURATED STEAM

	Temp. Deg. Fahr.	Heat of the Liquid	Latent Heat	Total Heat	Weight of 1 Cubic Foot, Lb.	Volume of 1 Lb., Cubic Feet
Vacuum In. Mer.	<i>t</i>	<i>h</i>	<i>L</i>	<i>H</i>	<i>S</i>	<i>Q</i>
25	133.2	101.1	1017.0	1118.1	.00689	145.2
20	161.2	129.0	1001.0	1130.0	.0133	75.2
15	178.9	146.8	990.4	1137.2	.0195	51.1
10	192.2	160.1	982.6	1142.7	.0255	39.7
5	202.9	170.9	975.9	1146.8	.0314	31.8
Gauge Pres.						
0	212.0	180.0	970.4	1150.4	.0373	26.8
5	227.2	195.3	960.6	1155.9	.0491	20.38
10	239.4	207.7	952.5	1160.2	.0607	16.40
15	249.8	218.2	954.5	1163.7	.0721	13.87
20	258.8	227.4	939.2	1166.6	.0834	11.99
25	266.8	235.6	933.6	1169.2	.0946	10.57
30	274.1	243.1	928.5	1171.6	.1058	9.47
35	280.6	249.7	923.8	1173.5	.1168	8.56
40	286.7	256.0	919.3	1175.3	.1278	7.82
45	292.4	261.8	915.2	1177.0	.1387	7.20
50	297.7	267.2	911.2	1178.4	.1497	6.68
55	302.6	272.3	907.4	1179.7	.1605	6.23
60	307.3	277.1	903.9	1181.0	.1714	5.83
65	311.8	281.7	900.5	1182.2	.1823	5.49
70	316.0	286.0	897.3	1183.3	.1930	5.18
75	320.1	290.3	894.1	1184.4	.2041	4.91
80	323.9	294.3	891.1	1185.4	.2145	4.66
85	327.6	298.1	888.2	1186.3	.2252	4.44
90	331.2	301.8	885.4	1187.2	.2358	4.24
95	334.6	305.3	882.6	1187.9	.2465	4.05
100	337.9	308.8	880.0	1188.8	.2570	3.89
105	341.1	312.1	877.4	1189.5	.2677	3.735
110	344.2	315.3	874.9	1190.2	.2785	3.592
115	347.2	318.4	872.5	1190.9	.2890	3.460
120	350.1	321.5	870.1	1191.6	.2996	3.338
125	352.9	324.4	867.8	1192.2	.3101	3.226
130	355.6	327.2	865.6	1192.8	.3207	3.118
135	358.3	330.0	863.4	1193.4	.3314	3.018
140	360.8	332.7	861.2	1193.9	.3419	2.925
145	363.4	335.4	859.0	1194.4	.3523	2.839
150	365.9	338.0	857.0	1195.0	.3627	2.758
155	368.4	340.6	854.8	1195.4	.3732	2.680
160	370.7	343.1	852.8	1195.9	.3837	2.606
165	373.0	345.5	850.9	1196.4	.3942	2.537
170	375.3	347.9	848.9	1196.8	.4046	2.472
175	377.5	350.3	847.0	1197.3	.4151	2.410
180	379.7	352.5	845.1	1197.7	.4256	2.350
185	381.8	354.8	843.3	1198.1	.4364	2.294
190	383.9	357.0	841.5	1198.5	.4464	2.240
195	385.9	359.1	839.7	1198.8	.4564	2.190
200	387.9	361.3	838.0	1199.3	.4670	2.141
210	391.8	365.4	834.5	1199.9	.488	2.049
220	395.5	369.3	831.2	1200.5	.508	1.966
230	399.2	373.2	828.0	1201.2	.529	1.889
240	402.6	376.9	824.8	1201.7	.550	1.818
250	406.1	380.6	821.7	1202.3	.570	1.752

MEASUREMENT OF STEAM

portions of the gauge were not equal. To make the heads equal, a reservoir **R** made of a 12 inch length of 3 inch pipe and two caps, is installed on each gauge line. These reservoirs are placed horizontal on the same level, above the gauge and connections, tapped in the center of one of the caps for connections to the main and in the bottom for connections in the gauge. When the steam enters the connections, reservoirs, and gauge, it will condense as these are not insulated or jacketed, and in a short time the water will fill both portions of the gauge, connections between the gauge and

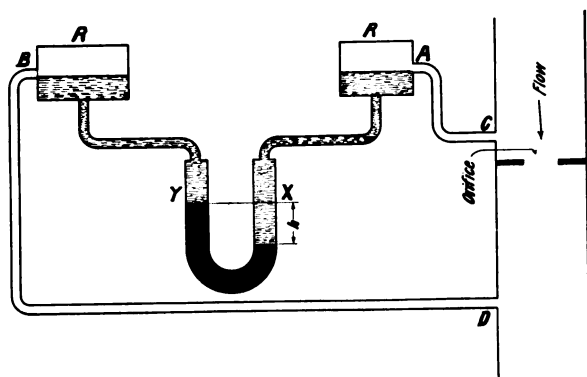

Fig. 115—SKETCH OF ORIFICE METER INSTALLATION FOR MEASURING STEAM IN A VERTICAL LINE

the reservoirs, and the lower portion of the reservoirs, any excess condensate returning to the main through connections **A C** and **B D**. These connections always slope toward the main to avoid trapping any water. Therefore, since the inlets to the reservoir which become the outlets for excess condensation are on the same level, the water pressures on each portion of the gauge are equal and balance one another for all differentials. When the differential h increases the water level at **A** is lowered and at **B** is raised, causing a portion to flow through the connection **B D** into the main. In

the meantime additional condensation is filling the reservoir **A** to the outlet level. This change of levels in the reservoir, for the short period of time it does exist, is immaterial for the reason that a volume of water equivalent to $\frac{1}{4}$ inch in depth of the reservoir is sufficient to fill the space vacated by the mercury throughout the total range of the gauge.

Due to the fact that the recording gauges are filled with water each inch of mercury differential is partially counter-balanced by an inch of water and therefore each inch of mercury differential is equivalent to only 12.6 inches of

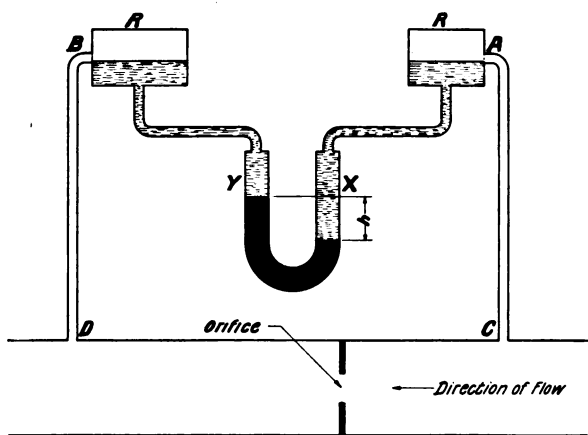

Fig. 116—SKETCH OF ORIFICE METER INSTALLATION FOR MEASURING STEAM IN A HORIZONTAL LINE

water differential instead of 13.6 inches which would be the case if the water did not fill the connections. Therefore a correcting factor $\frac{12.6}{13.6}$ must be introduced and the differential h be multiplied by this factor, for the reason that the gauges are constructed to indicate 13.6 inches of water pressure differential for each inch of mercury differential.

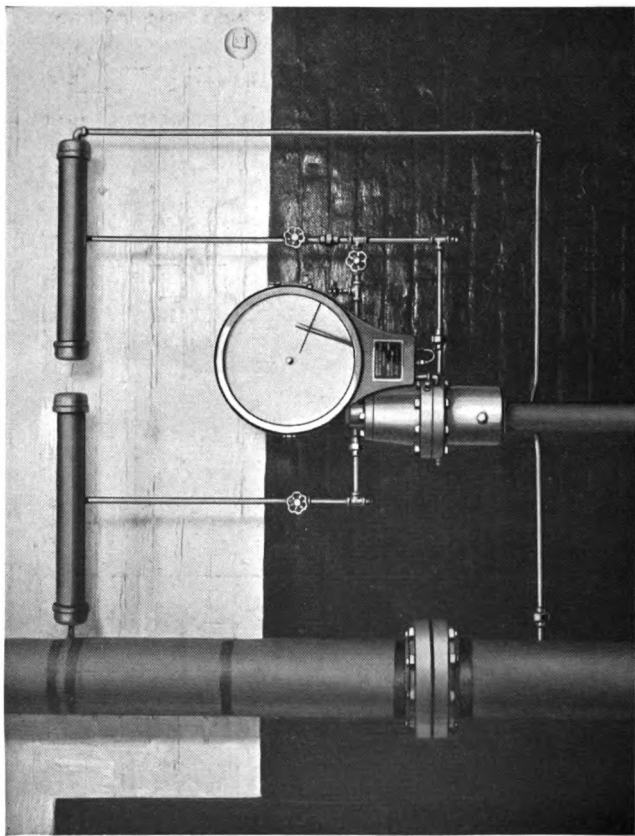

Fig. 117—MEASURING STEAM WITH A 60 INCH DIFFERENTIAL PRESSURE GAUGE

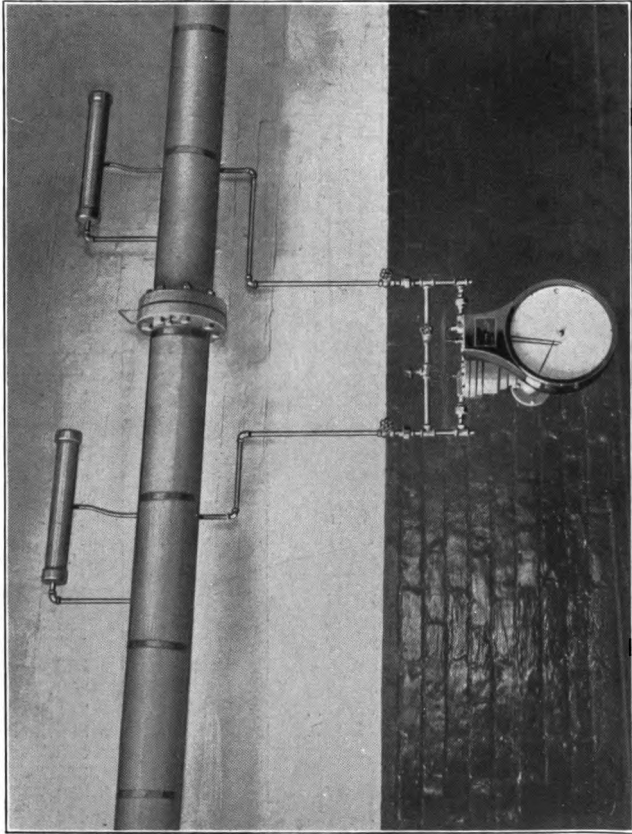

Fig. 118—MEASURING STEAM WITH A 50 INCH DIFFERENTIAL GAUGE

MEASUREMENT OF STEAM

**Table 53—HOURLY ORIFICE COEFFICIENTS
FOR STEAM**

Pressures taken $2\frac{1}{2}$ diameters upstream and 8 diameters downstream.
 Values of C in $W_1 = C \sqrt{hP}$ where W_1 = actual weight of saturated steam passing orifice in pounds per hour.
 Size of meter is diameter of pipe line in which orifice is placed.
 See Table 54 for correcting factors.

Diameter of Orifice Inches	Diameter of Pipe Line			
	4"	6"	8"	10"
$\frac{1}{2}$	2.515	2.500	2.492	2.490
$\frac{5}{8}$	3.950
$\frac{3}{4}$	5.725	5.654	5.631	5.617
$\frac{7}{8}$	7.857
1	10.36	10.13	10.06	10.02
$1\frac{1}{8}$	13.26
$1\frac{1}{4}$	16.58	15.99	15.80	15.72
$1\frac{3}{8}$	20.33
$1\frac{1}{2}$	24.58	23.32	22.91	22.72
$1\frac{5}{8}$	29.40
$1\frac{3}{4}$	34.90	32.20	31.44	31.08
$1\frac{7}{8}$	41.14
2	48.19	42.74	41.43	40.84
$2\frac{1}{8}$	56.23
$2\frac{1}{4}$	65.36	55.27	53.04	52.05
$2\frac{3}{8}$	76.15
$2\frac{1}{2}$	87.76	69.99	66.24	64.71
$2\frac{5}{8}$	101.5
$2\frac{3}{4}$	117.3	87.52	81.25	78.95
$2\frac{7}{8}$	135.2
3	155.8	108.1	98.28	94.79
$3\frac{1}{4}$	132.7	117.5	112.1
$3\frac{1}{2}$	162.1	139.5	131.8
$3\frac{3}{4}$	197.0	164.3	153.3
4	238.8	192.4	177.0
$4\frac{1}{4}$	288.6	224.7	203.1
$4\frac{1}{2}$	347.9	260.9	232.1
$4\frac{3}{4}$	303.1	264.0
5	350.2	299.3
$5\frac{1}{4}$	405.4	338.7
$5\frac{1}{2}$	468.4	381.6
$5\frac{3}{4}$	539.3	430.2
6	620.8	483.4
$6\frac{1}{4}$	542.8
$6\frac{1}{2}$	609.2
$6\frac{3}{4}$	683.1
7	765.7
$7\frac{1}{4}$	856.9
$7\frac{1}{2}$	957.3

Table 54

**MULTIPLIERS FOR VARIOUS GAUGE PRESSURES,
MOISTURE, AND SUPERHEAT**

Used with Table 53.

Percent- age of Moisture	Static Pressure Pounds Gauge					
	25	50	100	150	200	250
30	1.232	1.214	1.195	1.184	1.177	1.173
25	1.191	1.173	1.155	1.145	1.138	1.134
20	1.153	1.135	1.117	1.107	1.100	1.097
15	1.119	1.102	1.085	1.075	1.069	1.064
10	1.087	1.071	1.054	1.045	1.038	1.034
5	1.058	1.042	1.026	1.017	1.011	1.007
3	1.046	1.031	1.015	1.006	1.000	.997
2	1.041	1.026	1.010	1.001	.995	.992
1	1.036	1.021	1.005	.996	.990	.987
0	1.031	1.016	1.000	.991	.985	.981

Super- heat deg. fahr.						
20	1.016	1.001	.985	.976	.970	.967
50	.992	.978	.961	.952	.945	.940
100	.950	.945	.929	.919	.911	.904
150	.930	.915	.899	.889	.882	.877
200	.902	.890	.874	.863	.855	.846
250	.878	.866	.850	.839	.832	.826
300	.855	.843	.829	.819	.811	.805
400	.818	.806	.792	.781	.773	.768
500	.781	.770	.760	.750	.743	.737

The weight of steam per cubic foot varies approximately with the absolute pressure.

$$w = .002241 P$$

Where w = weight of steam in pounds per cubic foot.

P = the static pressure of steam expressed in absolute units being equal to the gauge pressure plus the atmospheric pressure.

Substituting these factors in $W_1 = 358.95 C_v d^2 \sqrt{h w}$

We obtain $W_1 = 358.95 C_v d^2 \sqrt{\frac{12.6 h \times .002241 P}{13.6}}$

$$\text{or } W_1 = 16.36 C_v d^2 \sqrt{h P} = C \sqrt{h P}$$

Where W_1 is equal to the actual weight of dry steam passing the orifice in pounds per hour.

The Hourly Orifice Coefficient, C in Table 53, is equal to $16.36 C_v d^2$.

The multipliers for revision of the Coefficients are determined by substituting the weight of the unsaturated or superheated steam in pounds per cubic foot (Page 277,) for w in the formula. These multipliers may be applied either to the coefficient or the calculated result.

The main purpose in measuring steam is to determine the amount of heat or power furnished by the boiler and supplied to the heat or power consuming units. The amount of steam power produced and consumed is expressed in "pounds from and at 212 deg. fahr." This term is a steam engineer's unit of measurement just as one of the units for the measurement of gas is a "cubic foot at 60 deg. fahr. at 4 ounces pressure." The expression "pound from and at 212 deg. fahr." is a unit of heat measurement being equal to 970.4 B. t. u., the number of heat units required to convert one pound of water "from" 212 deg. fahr. into dry steam "at" that temperature. A boiler horse power is equivalent to $34\frac{1}{2}$ "pounds of steam from and at 212 deg. fahr." The number of "pounds from and at 212 deg. fahr." may be either greater or less than the actual weight. For example, it takes 11587 B. t. u. to convert 10 lb. of water from 62 deg. fahr. into dry steam at 100 lb. gauge pressure and therefore the heat supplied to or the power content of the 10 lb. of steam is equal to 11587 B. t. u. divided by 970.4 B. t. u. or 11.94 "pounds from and at 212 deg. fahr." If the tempera-

ture of the water were 72 deg. fahr. or 10 degrees higher than the previous instance, the heat absorbed would be 11487 B. t. u. or equal to 11.83 "pounds from and at 212 deg. fahr.," about 1 per cent less. Although the actual weight is not changed the heat absorbed does change. The heat content of 1 lb. of steam at 100 lb. gauge pressure above water at a temperature of 62 deg. fahr. is 1158.7 B. t. u. and at 250 lb. pressure is 1172.2 B. t. u. above same temperature base. In other words, the unit "pounds from and at 212 deg. fahr." is the steam engineer's "yard stick." The power passing through the line could be expressed in B. t. u. just as well as in "pounds from and at 212 deg. fahr.," except that the B. t. u. unit is so small. Furthermore, this expression has become firmly established in the steam engineers' vocabulary by universal usage.

Just as in measuring gas or any fluid, whose volume per pound is affected by pressure and temperature, bases are established, so in measuring steam a temperature base is established from which all calculations are made. In gas measurement an average temperature of 60 deg. fahr. and an atmospheric pressure 14.4 lb. per sq. in. are used as bases. In calculating the value of the Hourly Orifice Coefficients for the measurement of the flow of steam (Page 287) we have used 62 deg. fahr. (a low feed water temperature) as a temperature base above which the heat content is expressed.

The heat content of steam for various pressures may be found in the Table of Properties of Steam, Page 277. The total heat content of steam for various pressures in this table is expressed above a temperature base of 32 deg. fahr. and to change to a base of 62 deg. fahr. 30.1 B. t. u. should be subtracted. The total heat content of steam at 100 lb. gauge pressure is 1188.8 minus 30.1 or 1158.7 B. t. u. above a temperature base of 62 deg. fahr.

To express the weight on the basis of heat units or *W* weight per hour in "pounds from and at 212 deg. fahr.,"

M E A S U R E M E N T O F S T E A M

we assume an average heat content of saturated steam per pound for all pressures as 1158.7 B. t. u. above a temperature base of 62 deg. fahr. This is an approximation but the net effect of using this value nearly cancels the error involved in assuming the value of w as equal to .002241 P for all pressures.

B. t. u. per pound "from and at 212 deg. fahr." = 970.4.

Then one pound of steam = $\frac{1158.7}{970.4} = 1.194$ "pounds from and at 212 deg. fahr."

Or $W = 1.194$ multiplied by the actual weight.

Where W = quantity of steam passing the orifice per hour in "pounds from and at 212 deg. fahr."

$$W = 1.194 \times 16.36 C_v d^2 \sqrt{h P}$$

$$W = 19.53 C_v d^2 \sqrt{h P}$$

in which formula $19.53 C_v d^2$ is equal to the value of C , the coefficient published in the Table of Hourly Orifice Coefficients for Steam on Page 287. In this Table a separate value is given for each diameter of orifice and each size of line, the value of C varying as the square of the diameter of orifice and directly with the value of C_v , C_v being dependent upon the ratio of the size of the orifice to the size of the pipe. Its value has been determined experimentally for all ratios.

In case the steam contains moisture its weight per cubic foot increases but this increase is more than offset by the decrease in the number of heat units contained in a pound and therefore the multiplier is less than 1 instead of greater, in expressing the power in "pounds from and at 212 deg. fahr." In the case of superheat the weight per cubic foot decreases more rapidly than the heat content per pound increases making the correcting factor less than unity instead of greater.

MEASUREMENT OF STEAM

Table 55—HOURLY ORIFICE COEFFICIENTS FOR STEAM

Pressures taken $2\frac{1}{2}$ diameters upstream and 8 diameters downstream.
 Values of C in $W = C \sqrt{hP}$ where W expresses quantity passing through orifice
 in "pounds of steam from and at 212 deg. Fahr."
 Size of Meter is diameter of pipe line in which orifice is placed.
 Heat content calculated above 62 deg. Fahr.

Diameter of Orifice Inches	Diameter of Pipe Line			
	4"	6"	8"	10"
$1\frac{1}{2}$	3.003	2.985	2.976	2.973
$5\frac{1}{8}$	4.716
$3\frac{3}{4}$	6.836	6.751	6.723	6.706
$7\frac{1}{8}$	9.382
1	12.37	12.10	12.01	11.97
$1\frac{1}{8}$	15.83
$1\frac{1}{4}$	19.79	19.10	18.87	18.77
$1\frac{3}{8}$	24.28
$1\frac{1}{2}$	29.35	27.84	27.36	27.13
$1\frac{5}{8}$	35.10
$1\frac{3}{4}$	41.67	38.44	37.54	37.12
$1\frac{7}{8}$	49.12
2	57.55	51.04	49.47	48.76
$2\frac{1}{8}$	67.14
$2\frac{1}{4}$	78.04	66.00	63.33	62.15
$2\frac{3}{8}$	90.93
$2\frac{1}{2}$	104.8	83.57	79.10	77.27
$2\frac{5}{8}$	121.2
$2\frac{3}{4}$	140.1	104.5	97.01	94.27
$2\frac{7}{8}$	161.5
3	186.1	129.1	117.3	113.2
$3\frac{1}{4}$	158.4	140.3	133.9
$3\frac{1}{2}$	193.5	166.6	157.4
$3\frac{3}{4}$	235.2	196.1	183.1
4	285.1	229.8	211.3
$4\frac{1}{4}$	344.6	268.3	242.5
$4\frac{1}{2}$	415.4	311.6	277.1
$4\frac{3}{4}$	361.9	315.2
5	418.2	357.4
$5\frac{1}{4}$	484.1	404.4
$5\frac{1}{2}$	559.2	455.6
$5\frac{3}{4}$	643.9	513.6
6	741.3	577.2
$6\frac{1}{4}$	648.1
$6\frac{1}{2}$	727.4
$6\frac{3}{4}$	815.6
7	914.3
$7\frac{1}{4}$	1023.
$7\frac{1}{2}$	1143.

MEASUREMENT OF STEAM

**Table 56—MULTIPLIERS FOR GAUGE PRESSURE,
MOISTURE, SUPERHEAT AND FEED WATER
TEMPERATURE**

To be used in connection with Table 55.

Gauge Pressure Pounds	Percentage of Moisture				Saturated Steam	Superheat deg. Fahr.				
	20	15	10	5		50	100	200	300	500
Feed Water Temperature 32 deg. Fahr.										
25	.977	.994	1.009	1.024	1.040	1.022	1.008	.986	.970	.950
50	.975	.990	1.005	1.019	1.033	1.017	1.003	.982	.966	.946
100	.976	.990	1.002	1.014	1.026	1.010	.996	.975	.960	.941
150	.978	.990	1.000	1.011	1.022	1.007	.992	.969	.955	.938
250	.982	.991	.999	1.009	1.017	1.003	.986	.962	.949	.931
Feed Water Temperature 62 deg. Fahr.										
25	.947	.965	.981	.997	1.013	.996	.983	.963	.948	.930
50	.946	.962	.978	.992	1.007	.992	.978	.959	.944	.926
100	.948	.961	.974	.988	1.000	.985	.972	.952	.938	.921
150	.949	.962	.973	.985	.996	.982	.968	.947	.934	.918
250	.954	.964	.972	.983	.992	.979	.963	.940	.928	.912
Feed Water Temperature 92 deg. Fahr.										
25	.917	.936	.953	.970	.987	.971	.958	.939	.926	.910
50	.917	.933	.950	.965	.980	.966	.954	.936	.922	.906
100	.919	.933	.947	.961	.975	.961	.948	.930	.917	.902
150	.921	.934	.946	.958	.971	.958	.944	.924	.913	.899
250	.926	.936	.945	.957	.967	.954	.940	.919	.907	.893
Feed Water Temperature 122 deg. Fahr.										
25	.888	.907	.924	.942	.960	.945	.933	.916	.903	.890
50	.887	.905	.922	.938	.954	.941	.929	.913	.900	.886
100	.890	.905	.920	.935	.949	.936	.924	.907	.895	.882
150	.892	.906	.919	.932	.945	.933	.920	.902	.892	.879
250	.897	.909	.918	.931	.941	.930	.916	.897	.886	.874
Feed Water Temperature 152 deg. Fahr.										
25	.858	.878	.896	.915	.933	.919	.909	.893	.881	.869
50	.858	.876	.894	.911	.928	.916	.905	.890	.879	.866
100	.861	.877	.893	.908	.923	.911	.900	.884	.874	.862
150	.863	.879	.892	.906	.919	.908	.897	.880	.870	.860
250	.869	.881	.892	.905	.916	.906	.893	.875	.866	.855
Feed Water Temperature 182 deg. Fahr.										
25	.828	.849	.868	.887	.907	.894	.884	.869	.859	.849
50	.828	.848	.867	.884	.901	.890	.880	.867	.857	.846
100	.832	.849	.865	.882	.897	.884	.876	.862	.852	.843
150	.835	.851	.865	.879	.894	.883	.873	.857	.849	.840
250	.840	.854	.865	.879	.890	.881	.869	.853	.845	.836
Feed Water Temperature 212 deg. Fahr.										
25	.798	.820	.840	.860	.880	.868	.859	.846	.837	.829
50	.799	.819	.839	.857	.875	.865	.856	.844	.835	.826
100	.803	.821	.838	.855	.871	.861	.852	.839	.831	.823
150	.806	.823	.838	.853	.868	.859	.849	.835	.828	.821
250	.812	.826	.838	.853	.865	.857	.846	.831	.824	.817

M E A S U R E M E N T O F S T E A M

The steam as measured usually contains the same percentage of moisture or amount of superheat and therefore the multiplier can be either applied to the hourly coefficient for the orifice or to the result.

Table 57—HORSE POWER—“POUNDS FROM AND AT 212 DEG. FAHR.”

Horse Power	Pounds from and at 212 deg. fahr.	Units of Evaporation or “pounds from and at 212 deg. fahr.”	Horse Power
1	34.5	1	.028986
2	69.0	2	.057971
3	103.5	3	.086957
4	138.0	4	.115942
5	172.5	5	.144928
6	207.0	6	.173913
7	241.5	7	.202899
8	276.0	8	.231884
9	310.5	9	.260870

Due to the fact that steam does not accurately follow the law of perfect gases, slight revisions were required for various gauge pressures, the Tables being calculated for 100 pounds gauge pressure.

It will be noted in the Table of Multipliers, Page 288, that the percentage differences between the multipliers are very small for wide differences in the percentage of moisture and quantity of superheat. The gain or loss in weight per cubic foot and loss and gain in heat content per pound partially offset each other. For this reason the orifice meter is most adaptable for the direct measurement of power.

The following examples illustrate the use of the Multipliers for revision of Coefficients.

Example—Steam being measured. Gauge Pressure, 200 lb. per square inch. Internal diameter of line, 6.065 inches. Diameter of orifice, 3 inches. 5 per cent moisture. Feed Water Temperature 182 deg. fahr. Actual weight desired.

In Table 53, Page 282, the Coefficient for a 6×3 orifice is 108.1, the Multiplier for revision is 1.011 (Table 54, Page 283) for 200 lb. static pressure containing 5 per cent moisture.

$$\text{The New Coefficient} = 108.1 \times 1.011 = 109.3.$$

If the power is desired in Table 55, Page 287, the Coefficient for a 6×3 orifice is 129.1, the Multiplier for 200 lb. static pressure, feed water temperature 182 degrees, 5 per cent moisture is .879. Table 56, Page 288.

$$\text{The New Coefficient} = 129.1 \times .879 = 113.5.$$

Therefore, a 6×3 orifice will pass 113.5 lb. of steam (from and at 212 deg. fahr.) at a theoretical absolute pressure of 1 lb. and at one inch differential per hour.

The values of *C*, the Hourly Orifice Coefficient for steam, contained in Tables 53 and 55, are prepared for pipe of standard dimensions (4.026, 6.065, 8.071, 10.191 inches internal diameter). Coefficients for pipes of other internal dimensions can be derived as follows.

Example—Steam being measured.

Internal diameter of pipe 3.548.

Diameter of Orifice $2\frac{1}{4}$ inches.

Actual Weight desired.

$$\text{Ratio } X = \frac{2.25}{3.548} = .6342$$

$$C_v \text{ for ratio } .6342 = .877 \text{ (Page 210).}$$

$$\begin{aligned} \text{Coefficient} &= 16.36 C_v d^2 \\ &= 16.36 \times .877 \times 2.25 \times 2.25 \\ &= 72.64 \text{ lb. of steam per hour.} \end{aligned}$$

The Multipliers applicable to Table 53 should be used where the pressure and quality of steam differ from 100 lb. gauge and saturated steam.

MEASUREMENT OF STEAM

Table 58—HOURLY CAPACITY OF ORIFICES FOR STEAM

Pressures taken $2\frac{1}{2}$ diameters upstream and 8 diameters downstream. Capacities expressed in pounds of steam per hour.
 Size of Meter is diameter of pipe line in which orifice is placed.

50 Inch Differential Chart.

Diam. Orifice Inches	2 Inch Meter						3 Inch Meter						4 Inch Meter					
	Gauge Pressure Pounds						Gauge Pressure Pounds						Gauge Pressure Pounds					
	25	50	100	200	25	50	100	200	25	50	100	200	25	50	100	200		
$\frac{1}{2}$	73	93	124	170	70	90	120	164	70	90	120	164	70	90	120	164		
$\frac{5}{8}$	115	147	200	270	112	144	190	260	112	144	190	260	112	144	190	260		
$\frac{3}{4}$	173	220	290	400	163	210	280	380	160	200	270	370	160	200	270	370		
$\frac{7}{8}$	240	310	420	570	230	290	390	520	220	280	380	510	220	280	380	510		
1	340	430	570	790	300	380	510	700	290	370	500	680	290	370	500	680		
$1\frac{1}{8}$	460	580	760	1050	390	500	660	900	370	480	640	870	370	480	640	870		
$1\frac{1}{4}$	620	790	1050	1440	490	630	840	1150	470	600	790	1090	470	600	790	1090		
$1\frac{3}{8}$	810	1040	1390	1900	620	790	1050	1440	570	730	970	1340	570	730	970	1340		
$1\frac{1}{2}$	1080	1400	1860	2500	760	970	1290	1770	690	880	1180	1600	690	880	1180	1600		
$1\frac{3}{4}$	1140	1470	1940	2600	980	1250	1640	2200	980	1250	1640	2200		
2	1690	2150	2900	3900	1850	2300	3100	4200	1850	2300	3100	4200		
$2\frac{1}{4}$	2440	3100	4200	5700	2470	3200	4200	5600	2470	3200	4200	5600		
$2\frac{1}{2}$		
$2\frac{3}{4}$		
3		

For Maximum Capacity add 50 per cent.
 For Minimum Capacity subtract 50 per cent.

MEASUREMENT OF STEAM

Table 59—HOURLY CAPACITY OF ORIFICES FOR STEAM

Pressures taken $2\frac{1}{2}$ diameters upstream and 8 diameters downstream. Capacities expressed in pounds of steam per hour.
Size of Meter is diameter of pipe line in which orifice is placed.

50 Inch Differential Chart.

Diam. Orifice Inches	6 Inch Meter						8 Inch Meter						10 Inch Meter						
	Gauge Pressure Pounds						Gauge Pressure Pounds						Gauge Pressure Pounds						
	25	50	100	200	50	100	200	25	50	100	200	25	50	100	200	25	50	100	200
$1\frac{1}{4}$	450	570	770	1050	440	570	760	1040	440	560	750	1030	440	560	750	1030	440	560	750
$1\frac{1}{2}$	660	830	1100	1520	650	820	1100	1500	640	810	1100	1500	640	810	1100	1500	640	810	1100
$1\frac{3}{4}$	900	1160	1540	2100	880	1120	1500	2100	870	1100	1500	2000	870	1100	1500	2000	870	1100	1500
2	1200	1540	2000	2800	1160	1480	2000	2700	1140	1460	1950	2700	1140	1460	1950	2700	1140	1460	1950
$2\frac{1}{2}$	2000	2500	3300	4600	1860	2400	3200	4300	1800	2300	3100	4300	1800	2300	3100	4300	1800	2300	3100
3	3000	3900	5200	7100	2700	3500	4700	6500	2700	3400	4500	6200	2700	3400	4500	6200	2700	3400	4500
$3\frac{1}{2}$	4500	5700	7700	10600	3900	5000	6700	9200	3700	4700	6300	8700	3700	4700	6300	8700	3700	4700	6300
4	6800	8600	11500	15800	5400	6900	9200	12600	5000	6300	8500	11600	5000	6300	8500	11600	5000	6300	8500
$4\frac{1}{2}$	9800	12500	16800	23000	7300	9300	12400	17000	6500	8300	11000	15200	6500	8300	11000	15200	6500	8300	11000
5	9800	12600	16800	23000	8400	10800	14400	20000	8400	10800	14400	20000	8400	10800	14400
$5\frac{1}{2}$	13200	16800	22000	31000	10700	13700	18200	25000	10700	13700	18200	25000	10700	13700	18200
6	17400	22000	30000	41000	13600	17200	23000	32000	13600	17200	23000	32000	13600	17200	23000
$6\frac{1}{2}$	17000	22000	29000	40000	17000	22000	29000	40000	17000	22000	29000
7
$7\frac{1}{2}$

For Maximum Capacity add 50 per cent.
For Minimum Capacity subtract 50 per cent.

MEASUREMENT OF STEAM

Table 60
SIZE OF ORIFICES FOR MEASURING STEAM

Pressures taken $2\frac{1}{2}$ diameters upstream and 8 diameters downstream.
Weight expressed in pounds of steam per hour. 50 inch Chart.
Size of Meter is diameter of pipe line in which orifice is placed.

Pounds per Hour	2 Inch Meter				3 Inch Meter				4 Inch Meter			
	Gauge Pressure Pounds				Gauge Pressure Pounds				Gauge Pressure Pounds			
	25	50	100	200	25	50	100	200	25	50	100	200
200	$\frac{3}{4}$	$\frac{3}{4}$	$\frac{5}{8}$	$\frac{1}{2}$	$\frac{5}{8}$	$\frac{3}{4}$	$\frac{5}{8}$	$\frac{1}{2}$	$\frac{7}{8}$	$\frac{3}{4}$	$\frac{5}{8}$	$\frac{1}{2}$
300	1	$\frac{7}{8}$	$\frac{3}{4}$	$\frac{5}{8}$	1	$\frac{7}{8}$	$\frac{3}{4}$	$\frac{5}{8}$	1	$\frac{7}{8}$	$\frac{3}{4}$	$\frac{5}{8}$
400	$1\frac{1}{8}$	1	$\frac{7}{8}$	$\frac{3}{4}$	$1\frac{1}{8}$	1	$\frac{7}{8}$	$\frac{3}{4}$	$1\frac{1}{8}$	1	$\frac{7}{8}$	$\frac{3}{4}$
600	$1\frac{1}{4}$	$1\frac{1}{8}$	1	$\frac{7}{8}$	$1\frac{3}{8}$	$1\frac{1}{4}$	1	$\frac{7}{8}$	$1\frac{3}{8}$	$1\frac{1}{4}$	$1\frac{1}{8}$	1
800	$1\frac{3}{8}$	$1\frac{1}{4}$	$1\frac{1}{8}$	1	$1\frac{1}{2}$	$1\frac{3}{8}$	$1\frac{1}{4}$	1	$1\frac{5}{8}$	$1\frac{3}{8}$	$1\frac{1}{4}$	$1\frac{1}{8}$
1000	$1\frac{1}{2}$	$1\frac{3}{8}$	$1\frac{1}{4}$	$1\frac{1}{8}$	$1\frac{3}{4}$	$1\frac{1}{2}$	$1\frac{3}{8}$	$1\frac{1}{8}$	$1\frac{3}{4}$	$1\frac{5}{8}$	$1\frac{3}{8}$	$1\frac{1}{4}$
1500	...	$1\frac{1}{2}$	$1\frac{3}{8}$	$1\frac{1}{4}$	2	$1\frac{3}{4}$	$1\frac{5}{8}$	$1\frac{3}{8}$	2	$1\frac{7}{8}$	$1\frac{5}{8}$	$1\frac{1}{2}$
2000	$1\frac{1}{2}$	$1\frac{3}{8}$	$2\frac{1}{8}$	2	$1\frac{3}{4}$	$1\frac{1}{2}$	$2\frac{1}{4}$	$2\frac{1}{8}$	$1\frac{3}{4}$	$1\frac{5}{8}$
3000	$1\frac{1}{2}$	$2\frac{1}{4}$	$2\frac{1}{4}$	2	$1\frac{3}{4}$	$2\frac{1}{2}$	$2\frac{1}{2}$	$2\frac{1}{4}$	2
4000	$2\frac{1}{4}$	2	3	$2\frac{3}{4}$	$2\frac{1}{2}$	$2\frac{1}{4}$
6000	$2\frac{1}{4}$...	3	$2\frac{3}{4}$	$2\frac{1}{2}$
8000	3	$2\frac{3}{4}$
10000	3

Pounds per Hour	6 Inch Meter				8 Inch Meter				10 Inch Meter			
	Gauge Pressure Pounds				Gauge Pressure Pounds				Gauge Pressure Pounds			
	25	50	100	200	25	50	100	200	25	50	100	200
400	$1\frac{1}{4}$	1	$\frac{7}{8}$	$\frac{3}{4}$	$1\frac{1}{4}$	1	$\frac{7}{8}$	$\frac{3}{4}$	$1\frac{1}{4}$	1	$\frac{7}{8}$	$\frac{3}{4}$
600	$1\frac{1}{2}$	$1\frac{1}{4}$	$1\frac{1}{8}$	1	$1\frac{1}{2}$	$1\frac{1}{4}$	$1\frac{1}{8}$	1	$1\frac{1}{2}$	$1\frac{1}{4}$	$1\frac{1}{8}$	1
800	$1\frac{5}{8}$	$1\frac{1}{2}$	$1\frac{1}{4}$	$1\frac{1}{8}$	$1\frac{3}{4}$	$1\frac{1}{2}$	$1\frac{1}{4}$	$1\frac{1}{8}$	$1\frac{3}{4}$	$1\frac{1}{2}$	$1\frac{1}{4}$	$1\frac{1}{8}$
1000	$1\frac{7}{8}$	$1\frac{3}{4}$	$1\frac{1}{2}$	$1\frac{1}{4}$	$1\frac{7}{8}$	$1\frac{3}{4}$	$1\frac{1}{2}$	$1\frac{1}{4}$	$1\frac{7}{8}$	$1\frac{3}{4}$	$1\frac{1}{2}$	$1\frac{1}{4}$
1500	$2\frac{1}{4}$	2	$1\frac{3}{4}$	$1\frac{1}{2}$	$2\frac{1}{4}$	2	$1\frac{3}{4}$	$1\frac{1}{2}$	$2\frac{1}{4}$	2	$1\frac{3}{4}$	$1\frac{1}{2}$
2000	$2\frac{1}{2}$	$2\frac{1}{4}$	2	$1\frac{3}{4}$	$2\frac{5}{8}$	$2\frac{1}{4}$	2	$1\frac{3}{4}$	$2\frac{5}{8}$	$2\frac{3}{8}$	2	$1\frac{3}{4}$
3000	3	$2\frac{5}{8}$	$2\frac{1}{2}$	2	3	$2\frac{3}{4}$	$2\frac{1}{2}$	2	3	$2\frac{7}{8}$	$2\frac{1}{2}$	$2\frac{1}{8}$
4000	$3\frac{1}{2}$	3	$2\frac{3}{4}$	$2\frac{3}{8}$	$3\frac{1}{2}$	3	$2\frac{3}{4}$	$2\frac{1}{2}$	$3\frac{1}{2}$	$3\frac{1}{4}$	$2\frac{7}{8}$	$2\frac{3}{8}$
6000	4	$3\frac{1}{2}$	3	$2\frac{3}{4}$	$4\frac{1}{4}$	$3\frac{3}{4}$	$3\frac{1}{4}$	3	$4\frac{1}{4}$	4	$3\frac{1}{2}$	3
8000	$4\frac{1}{4}$	4	$3\frac{1}{2}$	$3\frac{1}{4}$	$4\frac{1}{2}$	$4\frac{1}{4}$	$3\frac{3}{4}$	$3\frac{1}{4}$	5	$4\frac{1}{2}$	4	$3\frac{1}{2}$
10000	$4\frac{1}{2}$	$4\frac{1}{4}$	4	$3\frac{1}{2}$	5	$4\frac{1}{2}$	4	$3\frac{1}{2}$	$5\frac{1}{2}$	5	$4\frac{1}{2}$	$3\frac{3}{4}$
15000	...	$4\frac{1}{2}$	$4\frac{1}{2}$	4	$5\frac{1}{2}$	$5\frac{1}{2}$	5	$4\frac{1}{4}$	$6\frac{1}{4}$	$5\frac{1}{2}$	5	$4\frac{1}{2}$
20000	$4\frac{1}{4}$	6	6	$5\frac{1}{2}$	$4\frac{3}{4}$	$6\frac{3}{4}$	$6\frac{1}{2}$	$5\frac{3}{4}$	5
30000	6	$5\frac{1}{2}$	$7\frac{1}{2}$	$7\frac{1}{4}$	$6\frac{1}{2}$	6
40000	6	$7\frac{1}{4}$	$6\frac{1}{2}$
60000	$7\frac{1}{2}$

MEASUREMENT OF STEAM

STEAM COEFFICIENT TESTS

The following tests are a portion of series of tests which were conducted at the Metric Metal Works several years ago. The layout shown on Page 149 was used, in which a portion of the steam from the main header was measured through an orifice and subsequently weighed as condensate by passing the steam into a barrel of cold water.

Table 61

Orifice	Static Pressure lb.	Differential	Time Hr.	Quantity lb.	Coefficient	Remarks
Pipe Tap Connections						
4" x 3/4"	103.5	22.3	.0766	22.75	5.80	
4" x 3/4"	100.0	23.7	.0883	26.75	5.82	
4" x 3/4"	88.0	39.7	.0568	20.5	5.65	5.72a
4" x 3/4"	95.0	29.6	.0723	23.0	5.53	5.75c
4" x 3/4"	99.0	18.5	.1231	32.75	5.80	
4" x 3/4"	105.0	31.0	.1078	37.5	5.71	
4" x 3/4"	102.0	37.8	.0874	33.25	5.73	
4" x 1/2"	102.0	18.5	.2750	32.5	2.54	
4" x 1/2"	106.0	20.2	.2663	33.5	2.54	
4" x 1/2"	110.0	20.3	.2687	35.0	2.58	
4" x 1/2"	102.0	18.8	.2713	32.5	2.56	
4" x 1/2"	98.0	19.4	.2585	31.0	2.57	2.54a
4" x 1/2"	101.0	21.2	.2845	35.25	2.51	2.53c
4" x 1/2"	96.0	21.0	.2833	34.0	2.50	
4" x 1/2"	103.0	26.0	.2072	29.0	2.53	
4" x 1/2"	100.0	3.6	.5000	25.0	2.46	
4" x 1/2"	101.0	5.4	.4525	29.5	2.61	
4" x 1/2"	102.0	22.0	.2400	30.5	2.51	
4" x 1"	98.0	30.7	.0605	37.0	10.42	
4" x 1"	97.6	35.0	.0555	36.0	10.35	10.44a
4" x 1"	89.8	21.9	.0614	30.5	10.45	10.41c
4" x 1"	107.0	43.6	.0415	30.5	10.10	
Flange Connections						
4" x 1"	109.5	53.0	.0547	44.5	10.04	
4" x 1"	100.0	42.0	.0536	35.75	9.63	9.80a
4" x 1"	110.5	32.5	.0702	44.0	9.84	9.90c
4" x 1"	101.5	43.0	.0537	36.75	9.70	

In the column Remarks, (a) refers to the average value of the Coefficient obtained by the tests and (c) is the calculated value of the Coefficient obtained by assuming that the coefficient of velocity of steam is the same for steam as for air.

Preliminary tests indicated a serious discrepancy between the coefficients as obtained by the tests and the coefficients as obtained by calculating the value assuming the coefficient of velocity of steam the same as the coefficient of velocity for air. These discrepancies were attributed to condensation and after the lines were thoroughly insulated they continued with the result that the deviation was found to be due to pulsation as explained on Pages 146 to 151.

Previous experiments by French scientists have shown that the flow of steam through orifices indicated that the coefficient of velocity for steam and air was the same.

In order to verify the previous results, a portion of the tests were made when there were no reciprocating units connected with the line and a portion were conducted when the reciprocating units were operating. By making proper deduction for pulsation, as indicated before and after the test, the results obtained compared favorably with the results in cases where the reciprocating units were not in operation. As is noted the duration of the tests was very limited and the amount of condensate obtained was comparatively small. However, the above results indicate that the results obtained by early experimenters were correct.

In addition to the above series of tests, numerous tests have been conducted using the orifice meter and differential gauge by various refineries in which the duration of the tests lasted for several hours and in which condensate amounted to several hundred pounds where the percentage of moisture ranged from 0 to 15 per cent. The coefficients obtained in these tests ranged within 1 per cent of the published coefficients, some of them being higher and some lower and the average deviation was less than one-half of 1 per cent.

Some manufacturers of steam flow meters drill a small opening in the orifice disc below the orifices, even with the level of the lowest surface of the pipe when the orifice is

installed in a horizontal line. This small opening is based on the theory that any condensate forming ahead of the orifice will pass through the small opening. Subsequent tests have indicated that such an opening is entirely unnecessary in actual practice, for the reason that all of the moisture is carried through the orifice by the steam and that after the orifice has been in service a few moments no moisture can be obtained from a bleeder placed just ahead of the orifice.

INSTALLING AND TESTING STEAM METERS

See Pages 303 and 304.

To successfully measure steam with an orifice meter violent pulsation and vibration must be eliminated.

The steam main should be opened at a flange connection, old flanges removed and new flanges installed. The orifice disc is placed between the flanges using sheet asbestos gaskets shellaced to the flanges on each side of the orifice disc.

When pressures are taken at the flanges installed in a horizontal line, the flanges should be set up so that the connections are on the side or on the top.

In drilling openings for connections where the pressures are taken at points $2\frac{1}{2}$ diameters upstream and 8 diameters downstream from the orifice, the taps should be on level with the center of the pipe or on top of the pipe if the main is a horizontal line.

Connect the taps in the main or at the flanges with reservoirs each constructed of either a 12 inch length of 3 inch pipe or 2 feet of 2 inch pipe.

The tap in the reservoir should be at the middle point of the reservoir either at the side or in the end. Place the reservoirs in a horizontal position level with each other. Taps for connections from the reservoirs to the gauge should be in the bottom of the reservoirs. The pipe lines between the reservoirs and the main line should always drain toward the main. The reservoirs must be at the highest point in

the gauge line connection. Do not place reservoirs close to the main as it is desirable to keep them cool. However, they must be higher than the gauge.

Connect the reservoir (attached to the downstream connection **D** on the main), at tap in the bottom, with gauge at tap **L**. Place valve **X** in the line adjacent to the gauge.

Connect upstream reservoir, at tap in the bottom, with the gauge at tap **H** placing valve **W** near the gauge.

Install a by-pass placing valves at **Z** and **Y** and a pet-cock or valve at **K**.

The reservoirs when in operation will be half filled with water, level with the connection from the reservoirs to the main. The gauge lines from the reservoir to the gauge and the gauge itself will be filled with water when in operation. Therefore, in order to maintain a balanced pressure on both sides of the gauge due to condensation, the reservoirs must be level with each other and higher than the gauge itself. Valves near **U** and **D** are auxiliary valves used in long lines.

Setting up Gauge, Glass, Differential Pen Arm, Adding Mercury, Clock, Placing Chart, Pens and Ink, Vibrating Pen Arm, and Adjustments.

See the remarks contained under these various headings for measurement of gas. They apply for measurement of steam. See Pages 247 to 250.

Static Pen Arm—The static pressure arm will rest at a pressure equal to the head of water in the reservoir above the elevation of the static spring when there is no pressure in the main. Thus, if the reservoirs are $11\frac{1}{2}$ feet above the elevation of the static spring the pen should rest at 5 pounds, one pound being equivalent to 2.3 feet water head. The static pen can be adjusted to eliminate this difference by setting on zero when the gauge, gauge lines and reservoirs are filled with water.

Turning on Steam—Before turning steam pressure into gauge fill the gauge with water,

Open **K**, **Y** and **Z**

Then open **W** and **X** very slowly to admit water to the gauge and lines and release air through valve at **K** and at funnel.

Close **X**

After the air is eliminated close funnel

Close **Y** and **Z**

Open **X**

K should be left open

Be sure that valves **Y** and **Z** do not leak.

Orifice Capacities—After the gauge is in operation if the differential pen arm records near the maximum reading change the orifice to one of a larger size. If this is not possible and it is found that the flow of steam keeps the marking arm at or above the maximum differential circle it will be necessary to use a differential gauge of a higher range of differential. If, after 24 hours, the differential reading is at or below 10 per cent of the maximum range of the chart in inches, change the orifice for one of a smaller size or use a differential gauge with a smaller maximum range. For Orifice Capacities see Pages 291 and 292.

Checking Differential Gauge for Zero:—

Open **Y** slightly until water flows from **K**

Close **K**

Close **W** and **X**

Open **Y** and **Z**, then open **K**

The differential pen arm should return to zero.

Buoyancy of Float—The zero position of the pen arm in a gauge filled with water is not the same as when filled with air due to the increased buoyancy of the float on account of the water.

MEASUREMENT OF STEAM



Fig. 119—DIFFERENTIAL GAUGE WHICH INDICATES RATE OF FLOW PER HOUR. SEE PAGES 130 AND 131.
Patent applied for

Zero Float Position—The differential pen arm should be kept in a straight line at the flexible joint. The differential pen arm can be adjusted to zero by moving slightly at the flexible joint or at the connection with the shaft. When the pen arm rests at zero determine if the float is floating and not resting on the bottom of the mercury pot.

Partially close **Y**

Open **X** carefully when the differential pen should recede one-fourth inch or more (actual measurement) below the zero line. If the float rests on the bottom of the chamber at zero add mercury. See paragraph Adding Mercury, Page 247.

After test, close **X**

Open **Y**

Checking Differential Pen Arm—

Close **W** and **X**

Attach a single column glass tube with a rubber connection and nipple to tap at **P** and fasten tube in a rigid vertical position. See Figs. 120 and 121 for examples.

Open **K**, **Y** and **Z**

Open **W** and admit water slowly to expel air from **K**

Mark level of water in glass tube attached to connection at **P**

Close **Z**

By partially opening and closing **W** the reading can be checked with the column of water in the tube above the zero mark. One inch of water reading on the chart is equal to 0.926 inches of water head in the glass column above the zero position. The following Table indicates the various check readings.

MEASUREMENT OF STEAM

Table 62—CHECK READINGS FOR DIFFERENTIAL GAUGE FILLED WITH WATER

Differential Gauge Reading Inches	Water Column Head Inches	Differential Gauge Reading Inches	Water Column Head Inches
1	.93	10	9.3
2	1.85	20	18.5
3	2.77	30	27.7
4	3.71	40	37.1
5	4.63	50	46.3
6	5.56	60	55.6
7	6.49	70	64.9
8	7.41	80	74.1
9	8.34	90	83.4
		100	92.6

After Test, open **Z**, close **P**, then proceed as in Turning on Steam, Page 298.

The differential pen arm may be tested as in testing with gas if the water is removed from the gauge and air pressure is used.

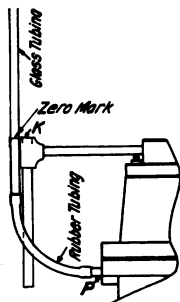

Fig. 120

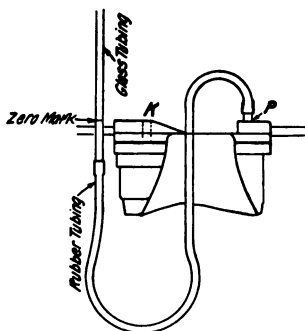

Fig. 121

Showing typical methods of attaching tube for water column test. Points **K** and **P** may be located at other openings as shown in the various installations.

Testing Static Spring—To test the static pressure gauge, attach the test gauge at **G**, and check the two gauges.

If the static spring is adjusted for head of water in gauge lines and reservoirs above the gauge, in testing, the adjustment should be added to the static pressure arm reading to check with the test gauge. See same subject, Page 258.

Leaks—Watch all connections for leaks. There should be no leaks at any connection. Special attention should be given to valve stems for leakage.

General—Before turning the pressure into the gauge, always make sure valves **W** and **X** are closed before opening valves **Y** and **Z** or either **Y** or **Z**. This precaution will eliminate the circulation of water through the by-pass, and heating of the gauge lines.

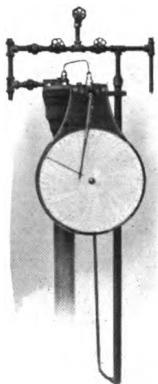

Fig. 122—400 INCH GAUGE USED FOR TESTING PURPOSES

MEASUREMENT OF STEAM

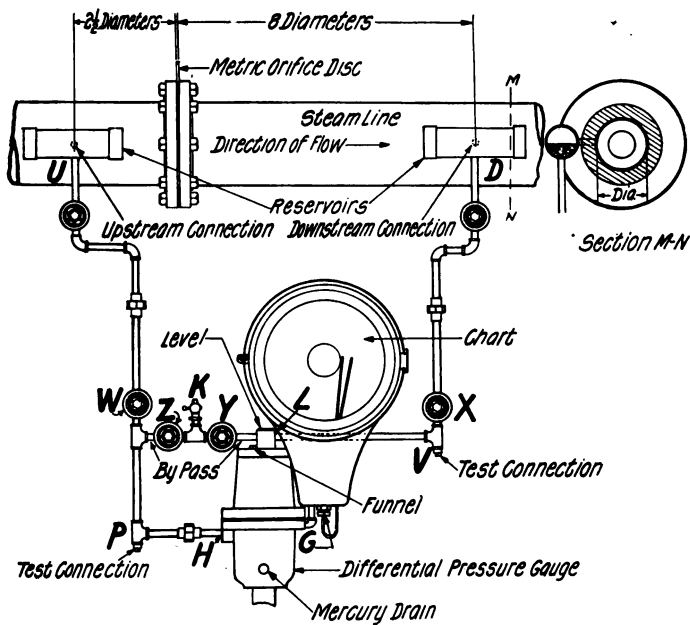

Fig. 123—50 INCH GAUGE INSTALLATION FOR MEASURING STEAM

MEASUREMENT OF STEAM

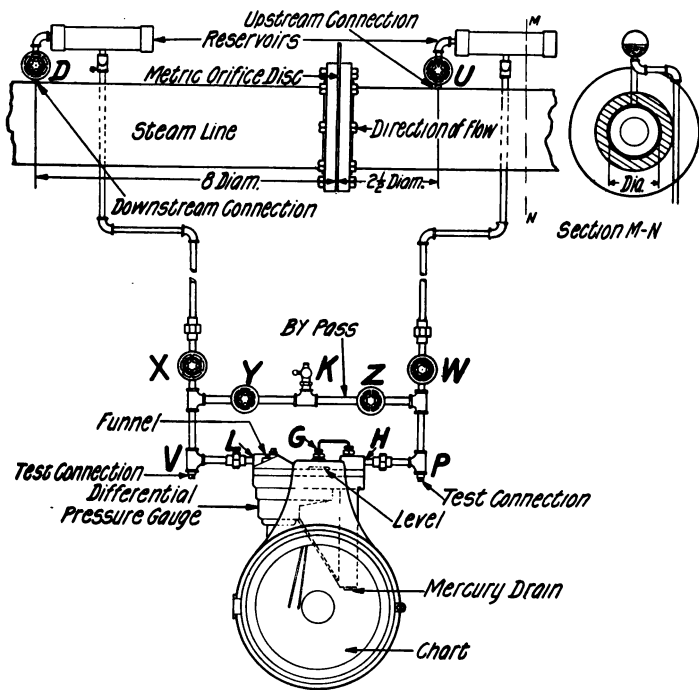

Fig. 124—50 or 100 INCH GAUGE INSTALLATION FOR MEASURING STEAM

READING CHARTS

The formula for use in measuring steam with the orifice meter is

$$\text{Quantity} = C \sqrt{h \times (A + p)}$$

C = Coefficient obtained from Table of Coefficients or calculated for the proper size of orifice, diameter of pipe, quality and pressure.

h = differential pressure in inches of water.

A = atmospheric pressure in lb. per square inch.

p = static pressure expressed in lb. per square inch.

To simplify all calculations, Tables of Pressure Extensions have been published which give the results of the formula

$$\sqrt{h \times (14.4 + p)}$$

in figures for various combinations of pressure and differential readings from 29 inches vacuum to 500 lb. pressure and from 1 inch to 100 inches differential. This eliminates the necessity of figuring out the formula for each reading in determining the volume of steam passing the meter. In this formula, the atmospheric pressure is assumed as 14.4 lb. Adjustment must be made to the static pen arm, or to the static pressure readings as explained on Page 297, on account of the elevation of the reservoirs above the gauge.

To obtain the quantity passing the meter, average the differential pressure (marked in red ink) and the static pressure (marked in black ink) on the chart for each hour.

If the differential pressure varies over wide ranges during the daily period, the method used for gas should be applied.

As the static pressure is usually fairly constant, average the differential reading for the day and the static reading for the day. The pressure extension is obtained for the average readings and is multiplied by the number of hours for which the average was obtained. This product is then multiplied by the Hourly Orifice Coefficient.

Frequently a planimeter and reference chart is used to obtain the average differential reading and average static reading. This method eliminates the necessity of recording the differential and static pressures on the chart and greatly simplifies the work. It should only be used when the static pressures or differential pressures do not vary over wide limits, as the results in such cases will be greater than the true result.

The pressure carried in steam lines does not usually vary over wide ranges, and quite frequently is almost constant. Due to this fact, the static pressure is not recorded by some makes of flow meters, thus these meters have a semblance of simplicity which does not really exist. Meters which record the static pressure as well as the differential pressure give the operator an accurate report of the condition at the meter.

When the static or line pressure is constant the work involved in obtaining the flow is greatly simplified. The formula $C\sqrt{hP}$ can be reduced to $C_s\sqrt{h}$ in which C_s is equal to $C\sqrt{P}$, P being the pressure extension for one inch differential. This steam Coefficient C_s is used as a multiplier for the sum of the hourly values of \sqrt{h} (Page 313).

Example—

Line Pressure, 100 lb.

Pipe Diameter, 4 inches.

Orifice Diameter, $2\frac{1}{2}$ inches.

$C = 87.76$ (Page 282)

$C_s = 87.76 \sqrt{100 + 14.4}$

$= 87.76 \times 10.696 = 938.7$

This Steam Coefficient is also used as the multiplier for the average differential reading obtained by using a planimeter and multiplying by 24.

All Orifice meter chart calculations are simplified by the use of the Orifice Meter Calculator, Page 267.

PART SIX

MEASUREMENT OF WATER.

The type of meter and gauge used for measuring water is identical with that used for measuring gas or air, with the exception that the static pressure spring may be omitted as water and oil are practically incompressible. The same types of charts are used, reducing to a minimum the various styles and amounts of supplies required, not to mention the decrease of maintenance and inspection. The operator needs to be familiar with only one type of meter and the office work is greatly simplified as only one kind of chart is to be read.

The measurement of water by the orifice meter is greatly simplified due to absence of all multipliers for revision of coefficients.

For each installation the orifice in the orifice disc, when placed in the pipe line, forms a definite section of unchanging area, and creates a definite difference between the static pressure of the fluid on the upstream side of the orifice, and the static pressure of the fluid on the downstream side of the orifice, for each velocity or rate of flow of the fluid, at the same density. This difference in static pressures is termed the differential pressure or the "differential." In other words the "differential," in cases of liquids, indicates the velocity.

The Differential Gauge records on a chart the differential pressure existing between the pressure connections. This factor with the known area of the orifice enables us to determine the flow from the formula:

$$Q = C \sqrt{h}$$

Where Q = the Quantity of liquid passing the orifice. The result can be expressed in "gallons" or "barrels" per hour.

C = the Hourly Coefficient. The value of this term remains the same for each installation and basis of measurement.

h = the Differential Pressure existing between the two pressure connections, expressed in inches of water head, this value is recorded graphically on the chart of the Recording Differential Gauge.

The value of the Hourly Orifice Coefficient C in the above formula is found on Page 312, computed for various diameters of orifice and diameters of pipe, these values having been determined by exhaustive experimental and practical tests in comparison with actual displacement. The extensions of the values of \sqrt{h} have been compiled and are given in Table 64.

Example—One hour reading (water being measured):

Average differential reading $h = 25$ inches.

Diameter of Pipe = 4 inches.

Diameter of Orifice = 2 inches.

Hourly Orifice Coefficient $C = 963.1$ for 2 inch orifice in a 4 inch line (Page 312).

Quantity per hour, $Q = 963.1 \sqrt{25}$

$$\begin{array}{rcc}
 \text{Orifice} & & \text{Pressure} \\
 = 963.1 & \times & 5.000 = 4816 \text{ gallons.} \\
 \text{Coefficient} & & \text{Extension.}
 \end{array}$$

Therefore the quantity per hour flowing in the line is equal to the Orifice Coefficient multiplied by the Differential.

The relation between the differential and the velocity of the fluid through the orifice is expressed by the formula:

$$V = C_v \sqrt{2gH}$$

Where V = velocity of flowing fluid in feet per second.

g = acceleration due to gravity in feet per sec., per sec. = 32.16.

H = differential expressed in feet head of flowing fluid.

The well known formula $V = \sqrt{2gH}$ expresses the theoretical flow eliminating friction and other influences. When applied to actual conditions a correcting factor is used to take care of influences due to contraction of jet, friction, etc. This correcting factor C_v is commonly known as the "coefficient of velocity."

In this formula the differential head is expressed in feet head of flowing fluid:

$$H = h/12$$

Where H = differential in feet head of flowing fluid.

h = differential in inches of water pressure.

12 = number of inches in a foot.

Substituting the value of H in formula $V = C_v \sqrt{2gH}$

$$\text{We obtain } V = C_v \sqrt{\frac{2gh}{12}} = C_v \sqrt{\frac{2 \times 32.16 \times h}{12}}$$

$$V = 2.3152 C_v \sqrt{h}$$

In measuring water with an orifice meter the connecting lines and the gauge itself are filled with water, thus the heads of liquid acting on each portion of the gauge are equal.

Due to the fact that the recording gauges are filled with water each inch of mercury differential is partially counter-balanced by an inch of water. Each inch of mercury differential is equivalent to only (13.6—1.0) inches of water differential instead of 13.6 inches which would be the case if the water did not fill the gauge and connections.

Where 13.6 = specific gravity of mercury.

1.0 = specific gravity of water in gauge.

Therefore, the differential h is multiplied by the factor 12.6/13.6 for the reason that differential gauges are constructed to indicate 13.6 inches of water pressure differential for each inch of mercury differential.

Substituting these factors in

$$V = 2.3152 C_v \sqrt{h}$$

we obtain

$$V = 2.3152 C_v \sqrt{\frac{12.6 h}{13.6}} = 2.2284 \sqrt{h}$$

The quantity of water passing the orifice in gallons per hour is equal to the area of the orifice in square inches multiplied by the velocity in inches per hour divided by 231. This fact may be expressed by the following formula:

$$Q = \frac{0.7854 d^2}{231} \times 3600 \times V \times 12$$

$$Q = 146.88 d^2 \times V$$

Where Q = quantity of water passing the orifice in gallons per hour.

0.7854 d^2 = area of orifice in square inches.

d = diameter of orifice in inches.

231 = number of cubic inches in a gallon.

3600 = seconds in one hour.

V = velocity of water through orifice in feet per sec.

12 = number of inches in a foot.

Substituting the value of V where $V = 2.2284 C_v \sqrt{h}$ in this expression.

$$Q = 146.88d^2 \times 2.2284C_v \sqrt{h}$$

$$Q = 327.31 C_v d^2 \sqrt{h} = C \sqrt{h}$$

The Hourly Coefficient C in Table 63 is equal to $327.31 C_v d^2$.

It has been found that the simple layout shown in Figs. 125 and 126 can be used very satisfactorily for measuring light oils or oils of low viscosity, see Part 7.

The values of C , the Hourly Orifice Coefficients for Water, are given in Table 63. These Coefficients are prepared for pipe of standard dimensions (2.067, 3.068, 4.026, 6.065, 8.071 and 10.191 inches internal diameter). Coefficients for pipes of other internal diameters for various sizes of orifices can be calculated as follows.

Example—Water being measured.

Internal Diameter of Pipe 7.981 inches.

Diameter of Orifice 4 inches.

$$\text{Ratio } X = \frac{4.000}{7.981} = .5012$$

C_v for ratio .5012 = .739 (Page 209).

$$\begin{aligned} \text{Coefficient} &= 327.31C_v d^2 \\ &= 327.31 \times .739 \times 4 \times 4 \\ &= 3870 \text{ gallons per hour.} \end{aligned}$$

MEASUREMENT OF WATER

Table 63

HOURLY ORIFICE COEFFICIENTS FOR WATER

Pressures taken $2\frac{1}{2}$ diameters upstream and 8 diameters downstream.

Values of C in $Q = C\sqrt{h}$ where Q expresses the quantity of water passing through the orifice in gallons per hour.

Size of Meter is the diameter of pipe line in which orifice is placed.

Diam. of Orifice Inches	DIAMETER OF PIPE LINE					
	2"	3"	4"	6"	8"	10"
$\frac{1}{2}$	51.69	50.68	50.22
$\frac{5}{8}$	82.42	79.96	79.04
$\frac{3}{4}$	122.1	116.4	114.7	113.0
$\frac{7}{8}$	172.8	160.5	157.3
1	237.7	213.1	207.2	202.8	200.9
$1\frac{1}{8}$	321.2	275.3	264.8
$1\frac{1}{4}$	429.3	348.6	330.7	320.0	316.1	313.8
$1\frac{3}{8}$	569.7	435.2	405.8
$1\frac{1}{2}$	752.2	537.5	491.1	466.0	458.6	454.5
$1\frac{5}{8}$	658.8	587.7
$1\frac{3}{4}$	802.9	697.3	642.8	628.9	622.1
$1\frac{7}{8}$	974.9	821.6
2	1180.	963.1	853.7	828.5	817.2
$2\frac{1}{8}$	1424.	1124.
$2\frac{1}{4}$	1716.	1308.	1104.	1059.	1041.
$2\frac{3}{8}$	1518.
$2\frac{1}{2}$	1758.	1399.	1323.	1294.
$2\frac{5}{8}$	2033.
$2\frac{3}{4}$	2347.	1749.	1623.	1577.
$2\frac{7}{8}$	2707.
3	3118.	2162.	1963.	1893.
$3\frac{1}{4}$	2654.	2349.	2244.
$3\frac{1}{2}$	3240.	2787.	2632.
$3\frac{3}{4}$	3940.	3283.	3061.
4	4777.	3848.	3535.
$4\frac{1}{4}$	5776.	4491.	4057.
$4\frac{1}{2}$	6973.	5224.	4636.
$4\frac{3}{4}$	6060.	5275.
5	7017.	5982.
$5\frac{1}{4}$	8112.	6766.
$5\frac{1}{2}$	9364.	7635.
$5\frac{3}{4}$	10800.	8600.
6	12430.	9674.
$6\frac{1}{4}$	10870.
$6\frac{1}{2}$	12190.
$6\frac{3}{4}$	13670.
7	15310.
$7\frac{1}{4}$	17130.
$7\frac{1}{2}$	19160.

MEASUREMENT OF WATER

Table 64
DIFFERENTIAL PRESSURE EXTENSIONS
 Values of \sqrt{h} from 1 to 100 Inches

Differential Reading h Inches	Extension \sqrt{h}	Differential Reading h Inches	Extension \sqrt{h}	Differential Reading h Inches	Extension \sqrt{h}
1.0	1.000	8.4	2.898	45	6.708
1.1	1.049	8.6	2.933	46	6.782
1.2	1.095	8.8	2.966	47	6.856
1.3	1.140	9.0	3.000	48	6.928
1.4	1.183	9.2	3.033	49	7.000
1.5	1.225	9.4	3.066	50	7.071
1.6	1.265	9.6	3.098	51	7.141
1.7	1.304	9.8	3.130	52	7.211
1.8	1.342	10.0	3.162	53	7.280
1.9	1.378	10.2	3.194	54	7.348
2.0	1.414	10.4	3.225	55	7.416
2.1	1.449	10.6	3.256	56	7.483
2.2	1.483	10.8	3.286	57	7.550
2.3	1.517	11.0	3.317	58	7.616
2.4	1.549	11.5	3.391	59	7.681
2.5	1.581	12.	3.464	60	7.746
2.6	1.612	12.5	3.536	61	7.810
2.7	1.643	13.	3.606	62	7.874
2.8	1.673	13.5	3.674	63	7.937
2.9	1.703	14.	3.742	64	8.000
3.0	1.732	14.5	3.808	65	8.062
3.1	1.761	15.	3.873	66	8.124
3.2	1.789	15.5	3.937	67	8.185
3.3	1.817	16.	4.000	68	8.246
3.4	1.844	16.5	4.062	69	8.307
3.5	1.871	17.	4.123	70	8.367
3.6	1.897	17.5	4.183	71	8.426
3.7	1.924	18.	4.243	72	8.485
3.8	1.949	18.5	4.301	73	8.544
3.9	1.975	19.	4.359	74	8.602
4.0	2.000	19.5	4.416	75	8.660
4.1	2.025	20.	4.472	76	8.718
4.2	2.049	20.5	4.528	77	8.775
4.3	2.074	21	4.583	78	8.832
4.4	2.098	22	4.639	79	8.888
4.5	2.121	23	4.796	80	8.944
4.6	2.145	24	4.899	81	9.000
4.7	2.168	25	5.000	82	9.055
4.8	2.191	26	5.099	83	9.110
4.9	2.214	27	5.196	84	9.165
5.0	2.236	28	5.292	85	9.220
5.2	2.280	29	5.385	86	9.274
5.4	2.324	30	5.477	87	9.327
5.6	2.366	31	5.568	88	9.381
5.8	2.408	32	5.657	89	9.434
6.0	2.449	33	5.745	90	9.487
6.2	2.490	34	5.831	91	9.539
6.4	2.530	35	5.916	92	9.592
6.6	2.569	36	6.000	93	9.644
6.8	2.608	37	6.083	94	9.695
7.0	2.646	38	6.164	95	9.747
7.2	2.683	39	6.245	96	9.798
7.4	2.720	40	6.325	97	9.849
7.6	2.757	41	6.403	98	9.899
7.8	2.793	42	6.481	99	9.950
8.0	2.828	43	6.557	100	10.000
8.2	2.864	44	6.633		

MEASUREMENT OF WATER

Table 65
HOURLY CAPACITIES OF ORIFICES FOR WATER

Pressures taken $2\frac{1}{2}$ Diameters Upstream and 8 Diameters Downstream.
Capacities expressed in Gallons.

Size of Meter is the Diameter of Pipe Line in which Orifice is placed.
50 Inch Differential Chart

Orifice Diam. Inches	Size of Meter			Orifice Diam. Inches	Size of Meter		
	2"	3"	4"		6"	8"	10"
$\frac{1}{2}$	232	227	225	$1\frac{1}{4}$	1430	1410	1400
$\frac{5}{8}$	370	358	353	$1\frac{1}{2}$	2090	2050	2030
$\frac{3}{4}$	550	520	510	$1\frac{3}{4}$	2880	2810	2780
$\frac{7}{8}$	780	720	700	2	3830	3710	3670
1	1080	960	930	$2\frac{1}{2}$	6300	5900	5800
$1\frac{1}{8}$	1460	1230	1190	3	9700	8800	8500
$1\frac{1}{4}$	1960	1570	1480	$3\frac{1}{2}$	14500	12500	11800
$1\frac{3}{8}$	2620	1950	1820	4	21400	17200	15800
$1\frac{1}{2}$	3460	2420	2200	$4\frac{1}{2}$	31100	23300	20800
$1\frac{3}{4}$	3620	3130	5	31300	26800
2	5370	4320	$5\frac{1}{2}$	42000	34200
$2\frac{1}{4}$	7800	5860	6	56000	43000
$2\frac{1}{2}$	7900	$6\frac{1}{2}$	55000
$2\frac{3}{4}$	10500	7	68000
3	14000	$7\frac{1}{2}$	86000

100 Inch Differential Chart

Orifice Diam. Inches	Size of Meter			Orifice Diam. Inches	Size of Meter		
	2"	3"	4"		6"	8"	10"
$\frac{1}{2}$	328	320	318	$1\frac{1}{4}$	2020	2000	2000
$\frac{5}{8}$	520	510	500	$1\frac{1}{2}$	2950	2900	2880
$\frac{3}{4}$	780	740	730	$1\frac{3}{4}$	4080	3980	3940
$\frac{7}{8}$	1100	1020	990	2	5400	5300	5200
1	1520	1350	1310	$2\frac{1}{2}$	8900	8400	8200
$1\frac{1}{8}$	2070	1750	1680	3	13700	12500	12000
$1\frac{1}{4}$	2780	2220	2100	$3\frac{1}{2}$	20500	17700	16700
$1\frac{3}{8}$	3700	2770	2570	4	30200	24400	22400
$1\frac{1}{2}$	4900	3420	3110	$4\frac{1}{2}$	44000	33000	29400
$1\frac{3}{4}$	5100	4420	5	44300	37000
2	7600	6100	$5\frac{1}{2}$	59000	48000
$2\frac{1}{4}$	11000	8300	6	79000	61000
$2\frac{1}{2}$	11100	$6\frac{1}{2}$	77000
$2\frac{3}{4}$	14900	7	97000
3	19700	$7\frac{1}{2}$	122000

For Minimum Capacity deduct 50 per cent., and for Maximum Capacity add 50 per cent.

MEASUREMENT OF WATER

WATER COEFFICIENT TESTS

In the following tests, **a** refers to the average value of the coefficient as obtained by the test. The calculated coefficient **c**, is the coefficient which was obtained by assuming that the "coefficient of velocity" for water was the same as the "coefficient of velocity" for air, the actual internal diameter of pipe being used in all instances. The results of the above tests substantiate the fact that the coefficient of velocity for air can be used as the coefficient of velocity for water in orifice meter computations.

Table 66

Orifice	Differential Inches	Time Seconds	Quantity Gallons	Coefficient	Remarks
Pressures taken 2½ diameters upstream and 8 diameters downstream					
2" x ½"	34.2	373	31.5	52.0	51.8a
2" x ½"	44.5	330	31.5	51.6	51.8c
2" x ¾"	38.0	148	31.5	124.5	
2" x ¾"	37.0	149	31.5	125.2	
2" x ¾"	36.0	150.5	31.5	125.5	125.0a
2" x ¾"	50.0	128.5	31.5	124.7	123.0c
2" x 1"	30.0	85.8	31.5	241.5	242.0a
2" x 1"	20.0	105.5	31.5	240.2	240.5c
2" x 1"	11.0	140.0	31.5	244.0	
4" x 1"	48.0	666.5	262.3	205.	205.0a
4" x 1"	35.0	770.0	259.0	205.	207.2c
4" x 1¾"	36.0	221.5	253.0	686.	
4" x 1¾"	23.0	271.0	256.5	713.	
4" x 1¾"	41.5	209.0	261.0	698.	700.0a
4" x 1¾"	30.5	241.5	260.0	702.	697.3c
4" x 1¾"	42.0	206.5	259.0	697.	
4" x 1¾"	23.0	279.0	261.0	704.	
Pressures taken at Flange					
2" x ¾"	44.0	153.0	31.5	111.8	112.1a
2" x ¾"	32.0	178.5	31.5	112.3	111.5c
4" x 1"	46.5	715.5	262.3	194.	195.0a
4" x 1"	48.0	680.0	256.5	196.	198.0c
4" x 1¾"	52.0	212.0	259.0	610.	613.0a
4" x 1¾"	29.0	277.0	255.5	616.	609.0c

INSTALLING AND TESTING WATER METERS

The preceding instructions relative to gas: **Measuring Gases and Liquids, Orifice Meter Body, Orifice Meter Flanges, Gauge Line Connections or Taps, Setting up Gauge, Differential Pen Arm, Glass, Adding Mercury, Static Pressure Connections**, (Pages 239 to 248) apply for measuring water with the following exceptions: In measuring water the installation may be made in any line whether level, inclined or vertical. The main line by-pass and valves may be omitted.

By Pass—Install by-pass, placing valve at **Z**.

Removing Chart, Clock, Placing Chart, Pens and Ink, Vibrating Pen Arm, and Adjustments (Pages 248–250, 258)—These articles apply with the exception that the static spring and pen arm are not necessary for measurement as these liquids are practically incompressible.

Starting Gauge—Fill gauge with water.

Open **Z**, **K** and **P**

Open valve **W** slightly to admit line pressure eliminating air at **K** and **P**. Open and close funnel to release all of the air. When all air is eliminated,

Close **P** and **K**

Open **W**

Close **Z**

Open **X**

Leaks—Stop all leaks.

Orifice Capacities—See Page 298. Same subject, these instructions apply for water as well as for steam. For capacities see Page 314.

Checking Differential Gauge for Zero—

Close **W** and **X**

Open **K** Open **Z**

The differential pen should return to zero.

The differential pen arm should be kept in a straight line. It can be adjusted to zero by moving slightly at the joint or at the connection with the shaft. When the pen rests at zero, determine if the float is floating and not resting on the bottom of the chamber. See Buoyancy of Float, Page 298.

Close **Z** and **K**

Partially open **P**

Then open **X** carefully when the differential pen should recede one-fourth inch or more (actual measurement) below the zero line. If the float rests on the bottom of the chamber at zero, add mercury. (See Adding Mercury.) Page 247.

After test close **P** and **X**

Open **Z**

Checking Differential Pen Arm—

Close **W** and **X**

Attach a single column glass tube with a rubber connection and nipple at tap **P** and fasten tube in a rigid vertical position. Page 301.

Open **K** and **Z**

Open **W** slightly and admit pressure slowly to expel air from **K**

Mark level of water in glass tube attached to connection at **P**.

Close **Z**

By opening and closing **W** the reading can be checked with the column of water in the tube above the zero mark. One inch of differential reading on the chart being equal to 0.926 inches of water head in the water column. See Table Page 301.

Reading Charts—See Page 340. These instructions, relative to Reading Charts, apply to the water measurement.

MEASUREMENT OF WATER

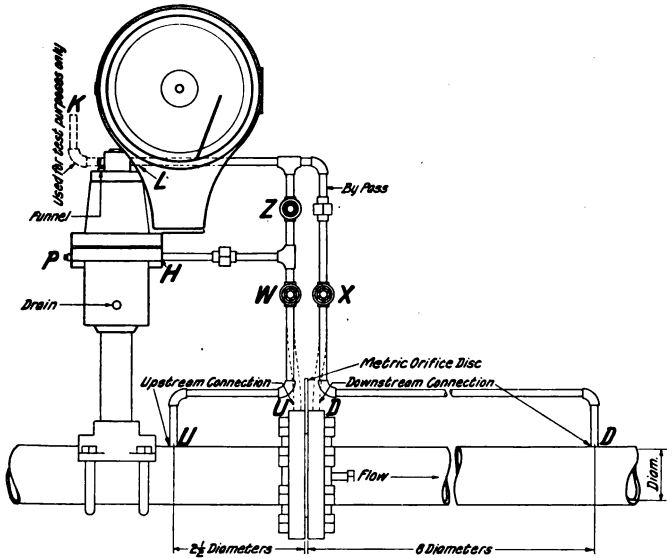

Fig. 125—50 INCH GAUGE INSTALLATION FOR MEASURING WATER OR LIGHT OILS. FLANGE CONNECTIONS SHOWN DOTTED

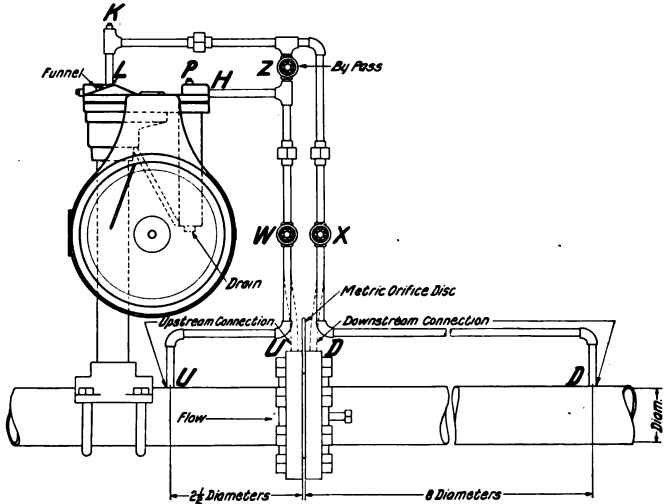

Fig. 126—50 OR 100 INCH GAUGE INSTALLATION FOR MEASURING WATER OR LIGHT OILS. FLANGE CONNECTIONS SHOWN DOTTED

PART SEVEN

MEASUREMENT OF OIL

The Orifice Meter in combination with the Differential Gauge was designed primarily to measure gases under high pressure. During the past few years they have been used successfully for measuring many kinds of liquids, such as gasoline, kerosene, crude oil, and reduced Mexican crude oil.

The type of meter and gauge used for measuring oil is identical with that used for measuring gas or air, with the exception that the static pressure spring may be omitted as water and oil are practically incompressible. The same types of charts are used, reducing to a minimum the various styles and amounts of supplies required, not to mention the decrease of maintenance and inspection. The operator needs to be familiar with only one type of meter and the office work is greatly simplified as only one kind of chart is to be read.

The meter is installed in the same manner as for measuring gas. Simply place an orifice in an orifice meter body or between two flanges in an existing line, making two small pipe pressure connections leading from the pipe line, one on each side of the orifice, to the differential gauge. The gauge may be installed at any location convenient for observation and inspection.

For each installation the orifice, in the orifice disc, when placed in the pipe line, forms a definite section of unchanging area, and creates a definite difference between the static

pressure of the fluid on the upstream side of the orifice, and the static pressure of the fluid on the downstream side of the orifice, for each velocity or rate of flow of the fluid, at the same density. This difference in static pressures is termed the differential pressure or the "differential." In other words the "differential," in cases of liquids, indicates the velocity.

The Differential Gauge records on a chart the differential pressure existing between the pressure connections. This factor with the known area of the orifice enables us to determine the flow of liquids from the formula:

$$Q = C \sqrt{h}$$

Where Q = the Quantity of liquid passing the orifice. The result can be expressed in "gallons" or "barrels" per hour.

C = the Hourly Coefficient. The value of this term remains the same for each installation and basis of measurement.

h = the Differential Pressure existing between the two pressure connections, expressed in inches of water head, this value is recorded graphically on the chart of the Recording Differential Gauge.

The value of the Hourly Orifice Coefficient C in the above formula is found on Page 330, computed for various diameters of orifice and diameters of pipe, these values having been determined by exhaustive experimental and practical tests in comparison with actual displacement. The extensions of the values of \sqrt{h} have been compiled and are given in Table 64 Page 313.

Example—One hour reading:

Average differential reading $h = 25$ inches.

Diameter of Pipe = 4 inches.

Diameter of Orifice = 2 inches.

MEASUREMENT OF OIL

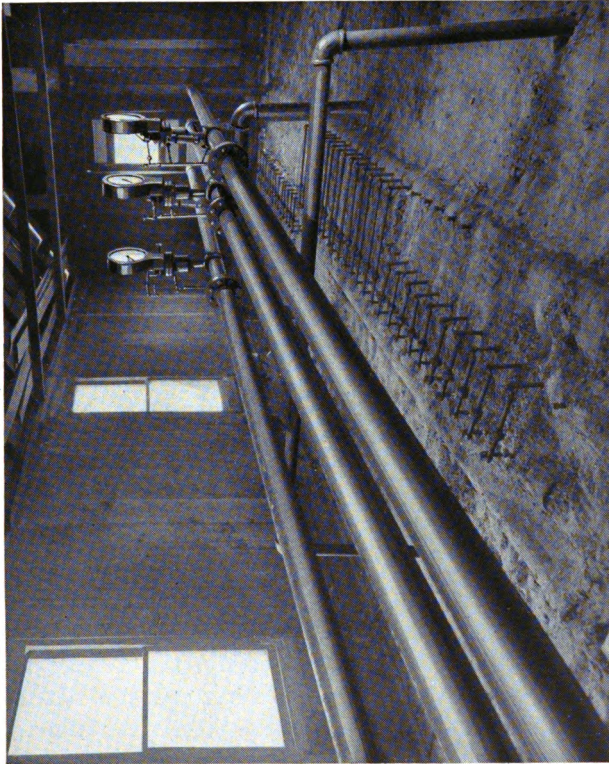

Fig. 127—ORIFICE METER INSTALLATIONS

When oil is measured (using the above data with Gravity 30 deg. Baume) the Hourly Orifice Coefficient C is 24.64 of a 2 inch orifice in a 4 inch line, (Table 67, Page 330).

$$Q = 24.64 \sqrt{25} \begin{array}{c} \text{Orifice} \\ \text{Coefficient} \end{array} \cdot \times \begin{array}{c} \text{Pressure} \\ \text{Extension} \end{array} = 24.64 \cdot \times 5.000$$

or the quantity passing through the orifice = 123.2 barrels per hour.

Therefore the quantity per hour flowing in the line is equal to the Orifice Coefficient multiplied by the Differential.

The relation between the differential and the velocity of the fluid through the orifice is expressed by the formula:

$$V = C_v \sqrt{2gH}$$

Where V = velocity of flowing fluid in feet per second.

g = acceleration due to gravity in feet per sec., per sec. = 32.16.

H = differential expressed in feet head of flowing fluid.

The well known formula $V = \sqrt{2gH}$ expresses the theoretical flow, eliminating friction and other influences. When applied to actual conditions a correcting factor is used to take care of influences due to contraction of jet, friction, etc. This correcting factor C_v is commonly known as the "coefficient of velocity."

In this formula the differential head is expressed in feet head of flowing fluid; and as it is not practical except in case of water to register this value directly, the differential is recorded on the chart in inches of water pressure. If oil of 30 deg. Baume is flowing in a line, the theoretical differential would be expressed in feet head of oil. The specific gravity of this oil is 0.875 therefore 0.875 feet or $10\frac{1}{2}$ inches of water would be equivalent to one foot of oil. One inch of water equals $1/10.5$ or 0.09525 feet of oil. Twenty inches of water would equal 20 times 0.09525 feet or 1.905 feet head of oil at 30 degrees.

$$H = \frac{h}{12\rho}$$

Where H = differential in feet head of flowing fluid.

h = differential in inches of water pressure.

12 = number of inches in a foot.

ρ = specific gravity of flowing fluid (water = 1.000)

The above example would be written thus:

$$H = \frac{20}{12 \times 0.875} = 1.905 \text{ feet of head oil.}$$

Substituting the value of H in the formula $V = C_v \sqrt{2gH}$

$$\text{We obtain } V = C_v \sqrt{\frac{2gh}{12\rho}} = C_v \sqrt{\frac{2 \times 32.16 \times h}{12\rho}}$$

$$V = 2.3152 C_v \sqrt{\frac{h}{\rho}}$$

This expression illustrates the fact that the velocity depends upon the specific gravity of the liquid. As the specific gravity increases, the velocity decreases when the differential pressure is a constant.

Or using a plain illustration with the same force applied, a cubic foot of hot tar will move with less speed or velocity than the same quantity of gasoline.

In measuring light or heavy oils with an orifice meter the connecting lines and the gauge itself are filled with water or oil and thus the heads of liquid acting on each portion of the gauge are equal.

Due to the fact that the recording gauges are filled with liquid each inch of mercury differential is partially counter-balanced by an inch of liquid. Each inch of mercury differential is equivalent to only $(13.6 - \rho_g)$ inches of water differential instead of 13.6 inches which would be the case if the liquid did not fill the gauge and connections.

Where 13.6 = specific gravity of mercury.

ρ_g = specific gravity of liquid in gauge.

Therefore, the differential h is multiplied by the factor $\frac{13.6 - \rho_g}{13.6}$ for the reason that differential gauges are constructed to indicate 13.6 inches of water pressure differential for each inch of mercury differential.

Substituting these factors in

$$V = 2.3152 C_v \sqrt{\frac{h}{\rho}}$$

we obtain

$$V = 2.3152 C_v \sqrt{\frac{(13.6 - \rho_g) h}{13.6 \rho}}$$

The quantity of fluid passing the orifice in gallons per hour is equal to the area of the orifice in square inches multiplied by the velocity in inches per hour divided by 231. This fact may be expressed by the following formula:

$$Q = \frac{0.7854 d^2}{231} \times 3600 \times V \times 12$$

$$Q = 146.88 d^2 \times V$$

Where Q = quantity of fluid passing the orifice in gallons per hour.

0.7854 d^2 = area of orifice in square inches.

d = diameter of orifice in inches.

231 = number of cubic inches in a gallon.

3600 = seconds in one hour.

V = velocity of fluid through orifice in feet per sec.

12 = number of inches in a foot.

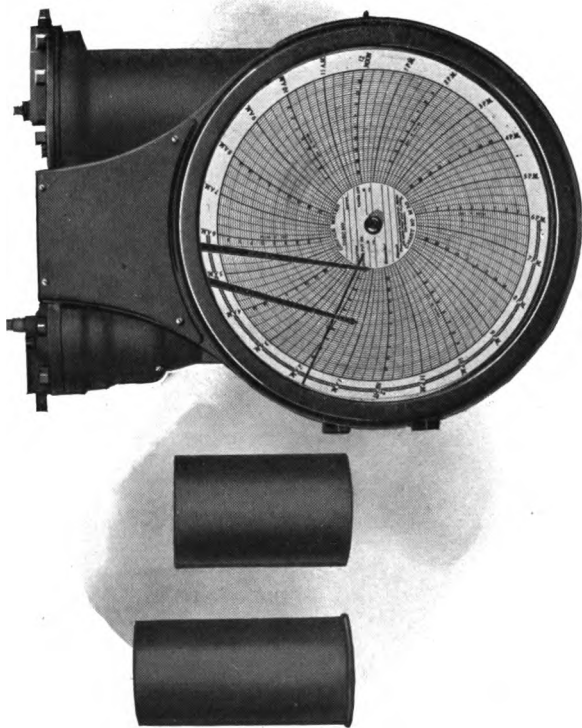

Fig. 128—COMBINATION DIFFERENTIAL GAUGE. RANGE 0 TO 25 INCHES AND 0 TO 100 INCHES.
LARGE BUSHING USED IN HIGH PRESSURE CHAMBER FOR 100 INCH RANGE.
SMALL BUSHING FOR 0 TO 25 INCH RANGE. SEE PAGE 129

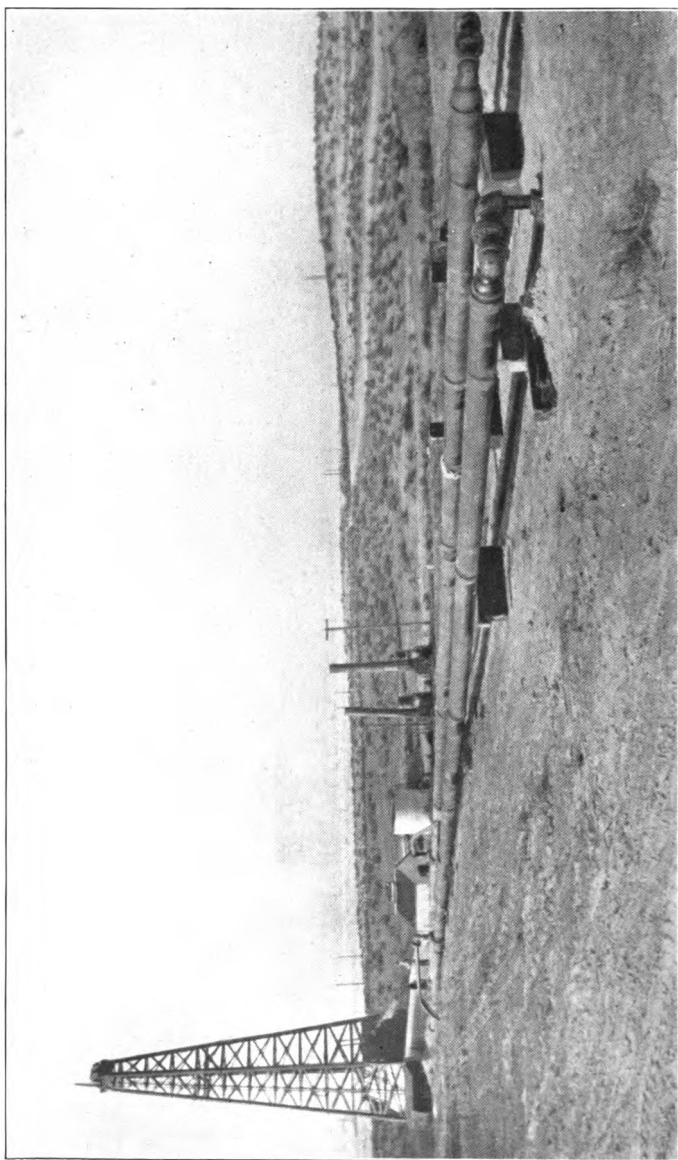

Fig. 189—OIL AND GAS SEPARATOR

MEASUREMENT OF OIL

Substituting the value of V where $V = 2.3152 C_v \sqrt{\frac{(13.6 - \rho_g) h}{13.6 \rho}}$

in this expression.

$$Q = 146.88 d^2 \times 2.3152 C_v \sqrt{\frac{(13.6 - \rho_g) h}{13.6 \rho}}$$

$$Q = 340.06 C_v d^2 \sqrt{\frac{(13.6 - \rho_g) h}{13.6 \rho}}$$

It has been found that the simple layout shown on Page 318 can be used very satisfactorily for measuring light oils or oils of low viscosity.

For heavy oils, reservoirs (Figs. 131 and 132) made of a 12 inch length of 4 or 6 inch pipe and two caps, are installed on each gauge line. These reservoirs are installed vertically on the same level. The reservoirs and gauge are filled with water. When oil is admitted to the reservoirs from the main and when the gauge is open, the air in the gauge lines and gauge will be displaced by the water. The excess water being released by valves **RR**. Figs. 131 and 132, so that the water occupies about one half of the height of the reservoir. When the by-pass lines are open and a flow does not exist through the orifice, the surface of the water will seek the same level and the pressure head of the liquids in the gauge lines and gauge will be equal. When a flow exists and the differential h increases, the water level at **S** is lowered and at **T** is raised, (Fig. 130) causing a portion of the oil to flow through the connection into the main at **D**. In the meantime additional oil is filling the reservoir **S**.

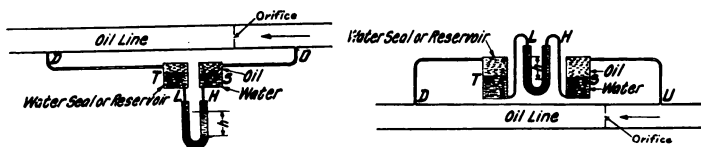

Fig. 130—DIAGRAM OF ORIFICE METER INSTALLATION
FOR MEASURING HEAVY OIL

When the oil is measured without the installation of water seals, the oil occupies the gauge lines and gauge itself. In this case ρ_g and ρ are equal to the specific gravity of the oil being measured. Table 67 was prepared, using as a basis, oil of 30 deg. Baume or specific gravity .875. The previous formulae give results in gallons per hour. To express the quantity in barrels of 42 gallons per hour, of oil of 30 deg. B., the formula

$$Q = 340.06 C_v d^2 \sqrt{\frac{(13.6 - \rho_g)h}{13.6\rho}} \quad \text{becomes}$$

$$Q = \frac{340.06 C_v d^2}{42} \sqrt{\frac{(13.6 - .875) h}{13.6 \times .875}}$$

$$Q = 8.3728 C_v d^2 \sqrt{h}$$

where Q = quantity in barrels of 42 gallons per hour.

The Hourly Coefficient C in Table 67 is equal to $8.3728 C_v d^2$.

The various multipliers shown in Table 68 were determined by using various values of specific gravities of liquids for ρ_g and ρ in the formula and take into account the difference in water levels occurring in various sizes of reservoirs due to displacement above and below the zero level occasioned by the volume of mercury displaced in the gauge. See following example (Page 329) for use of multipliers.

Investigations and tests have shown that the coefficient of velocity C_v for water and oils whose viscosity is less than water is practically the same as for gas, air, or steam. The compiled data of some of the tests given on Pages 333 and 334, indicate that there is no substantial difference. In computing the Tables of Hourly Orifice Coefficients, the values of C_v , determined for air, have been used.

MEASUREMENT OF OIL

The values of C , the Hourly Orifice Coefficient, for oil of 30 deg. B. are given in Table 67 on Page 330. These Coefficients are prepared for pipe of standard dimensions (2.067, 3.068, 4.026, 6.065, 8.071 and 10.191 inches internal diameter). Coefficients for pipes of other internal diameters for various sizes of orifices can be determined as follows.

Example—Oil being measured. 40 deg. Baume. Viscosity, 40 seconds Saybolt. Water seals, 6 inches in diameter, 50 inch gauge.

Internal Diameter of Pipe = 3.548 inches.

Diameter of Orifice = $2\frac{1}{4}$ inches.

$$\text{Ratio } X = \frac{2.250}{3.548} = .6342$$

C_p for ratio .6342 = .877 (Page 210).

Coefficient = $8.3728 C_p d^2$.

$$= 8.3728 \times .877 \times 2.25 \times 2.25$$

= 37.17 barrels per hour for 30 deg. Baume
without reservoirs.

Revision for Coefficient from 30 deg. Baume to 40 deg. Baume including revision on account of water seals and range of gauge (Table 68) = 1.027. Revision for viscosity (Table 69) = 1.020.

Coefficient for above conditions = $37.17 \times 1.027 \times 1.020 = 38.93$.

M E A S U R E M E N T O F O I L

Table 67
HOURLY COEFFICIENTS FOR OIL

Pressures taken $2\frac{1}{2}$ diameters upstream and 8 diameters downstream.

Values of C in $Q = C \sqrt{h}$ where Q expresses the quantity of oil or other liquids in Barre's (42 gallons) having a density of 30 deg. Baume, passing through the orifice per hour.

Size of meter is the diameter of pipe line in which orifice is placed.

Diam. of Orifice Inches	DIAMETER OF PIPE LINE					
	2"	3"	4"	6"	8"	10"
$\frac{1}{2}$	1.322	1.296	1.285
$\frac{5}{8}$	2.108	2.046	2.022
$\frac{3}{4}$	3.123	2.977	2.933	2.890
$\frac{7}{8}$	4.420	4.106	4.023
1	6.080	5.451	5.299	5.188	5.138
$1\frac{1}{8}$	8.217	7.043	6.773
$1\frac{1}{4}$	10.98	8.918	8.461	8.186	8.086	8.026
$1\frac{3}{8}$	14.57	11.13	10.38
$1\frac{1}{2}$	19.24	13.75	12.56	11.92	11.73	11.63
$1\frac{5}{8}$	16.85	15.03
$1\frac{3}{4}$	20.54	17.84	16.44	16.09	15.91
$1\frac{7}{8}$	24.94	21.02
2	30.18	24.64	21.84	21.19	20.90
$2\frac{1}{8}$	36.43	28.76
$2\frac{1}{4}$	43.90	33.46	28.24	27.08	26.62
$2\frac{3}{8}$	38.83
$2\frac{1}{2}$	44.97	35.79	33.83	33.09
$2\frac{5}{8}$	52.00
$2\frac{3}{4}$	60.05	44.73	41.51	40.34
$2\frac{7}{8}$	69.23
3	79.76	55.31	50.22	48.43
$3\frac{1}{4}$	67.89	60.09	57.40
$3\frac{1}{2}$	82.88	71.28	67.32
$3\frac{3}{4}$	100.8	83.99	78.31
4	122.2	98.42	90.43
$4\frac{1}{4}$	147.8	114.9	103.8
$4\frac{1}{2}$	178.4	133.6	118.6
$4\frac{3}{4}$	155.0	134.9
5	179.5	153.0
$5\frac{1}{4}$	207.5	173.1
$5\frac{1}{2}$	239.5	195.3
$5\frac{3}{4}$	276.2	220.0
6	317.9	247.5
$6\frac{1}{4}$	278.0
$6\frac{1}{2}$	311.8
$6\frac{3}{4}$	349.6
7	391.6
$7\frac{1}{4}$	438.2
$7\frac{1}{2}$	490.0

See Tables 68 and 69 for Multipliers for Specific Gravity and Viscosity.

MEASUREMENT OF OIL

**Table 68—MULTIPLIERS FOR HOURLY COEFFICIENTS
FOR OIL FOR VARIOUS SPECIFIC GRAVITIES
OF OIL WHEN USING WATER SEALS OR
RESERVOIRS OF VARIOUS SIZES.**

USED WITH TABLE 67

Gravity of Oil Degrees Baume	50" gauge 2½" res. or no res.	100" gauge 1¾" res. or no res.	50" gauge 4" res.	100" gauge 4" res.	50" gauge 6" res.	100" gauge 6" res.	Reser- voirs unlim- ited Area
10	.931	.931	.931	.931	.931	.931	.931
20	.966	.966	.965	.964	.964	.964	.964
30	1.000	1.000	.997	.996	.996	.996	.995
40	1.033	1.033	1.029	1.027	1.027	1.026	1.026
50	1.065	1.065	1.059	1.057	1.057	1.056	1.055
60	1.096	1.096	1.089	1.087	1.086	1.085	1.084
70	1.126	1.126	1.118	1.115	1.114	1.113	1.112
80	1.155	1.155	1.146	1.143	1.142	1.141	1.140
90	1.184	1.184	1.173	1.170	1.169	1.168	1.167
100	1.211	1.211	1.200	1.197	1.196	1.195	1.193
Minimum distance between connect'ns	8"	12"	6"	6"	4"	4"	2"

The reservoirs made of pipe are installed vertically.

The minimum distance mentioned is between the inlet connections and outlet connections of the reservoirs.

**Table 69—MULTIPLIERS FOR HOURLY ORIFICE
COEFFICIENTS FOR OIL FOR VISCOSITY**

USED WITH TABLE 67

Viscosity Saybolt Seconds	Multipliers	Viscosity Saybolt Seconds	Multipliers
40	1.020	150	1.080
50	1.035	200	1.092
60	1.045	300	1.107
70	1.052	500	1.126
80	1.058	700	1.140
100	1.066	1000	1.150

MEASUREMENT OF OIL

Table 70
HOURLY CAPACITIES OF ORIFICES FOR OIL

Pressures taken 2½ Diameters Upstream and 8 Diameters Downstream.
Capacities expressed in Barrels of 42 Gallons.

Size of Meter is the Diameter of Pipe Line in which Orifice is placed.
50 Inch Differential Chart

Diam. Orifice Inches	Size of Meter			Diam. Orifice Inches	Size of Meter		
	2"	3"	4"		6"	8"	10"
½	5.9	5.8	5.8	1¼	37	36	36
⅝	9.5	9.2	9.0	1½	53	52	52
¾	14.1	13.3	13.1	1¾	74	72	71
⅞	19.9	18.4	18.0	2	98	95	94
1	27.5	24.5	23.8	2½	160	152	148
1⅛	37.4	31.7	30.4	3	248	225	217
1¼	50.2	40.1	38.0	3½	371	319	302
1⅝	67.0	50.0	46.6	4	546	440	405
1⅞	88.5	61.9	56.3	4½	796	597	531
1¾	92.9	79.9	5	802	685
2	137	110	5½	1070	873
2¼	199	150	6	1420	1110
2½	201	6½	1390
2¾	268	7	1750
3	357	7½	2190

100 Inch Differential Chart

Diam. Orifice Inches	Size of Meter			Diam. Orifice Inches	Size of Meter		
	2"	3"	4"		6"	8"	10"
½	8.4	8.2	8.2	1¼	52	51	51
⅝	13.4	13.0	12.8	1½	76	74	74
¾	19.9	18.9	18.5	1¾	104	102	101
⅞	28.2	26.1	25.4	2	138	134	132
1	38.9	34.7	33.6	2½	227	214	210
1⅛	53	45	43	3	350	318	307
1¼	71	57	54	3½	525	452	427
1⅝	95	71	66	4	773	623	573
1⅞	125	88	80	4½	1126	845	751
1¾	131	113	5	1134	969
2	194	156	5½	1520	1240
2¼	281	212	6	2010	1570
2½	284	6½	1970
2¾	380	7	2480
3	505	7½	3100

For Minimum Capacity deduct 50 per cent., and for Maximum Capacity add 50 per cent.

MEASUREMENT OF OIL

TESTS—MEASUREMENT OF OIL

Following is a summary of tests conducted for measurement of various grades of oils by orifice meter.

Table 71

Number of Tests	Grade	Line Size	Av. Time Tests (hrs.)	Total Quantity (bbls.)	Viscosity Factor	Average Deviation %	Deviation of Total
4	Kerosene Dis.	8"	2.2	2,800	1.000	1.0	+0.7%
2	Caddo Crude	10"	10.0	18,700	1.000	2.2	+0.7%
2	Coastal Crude	8"	10.0	9,600	1.050	0.2	+0.2%
11	Mex. Crude	10"	5.9	49,500	1.146	2.3	+2.0%
26	Reduced Mexican Crude	3"	0.3	475	{ 1.118 to 1.144	2.5	-0.9%

The results indicate that for oils having a viscosity equal to or less than water, the coefficients of velocity derived for air flow can be used by applying a factor for gravity only, and when oils have a viscosity greater than water the viscosity factor must also be applied.

The above series of tests was conducted for the purpose of determining whether the viscosity of oil or liquids would require the use of a coefficient or multiplier for liquids of various viscosities.

The preliminary tests conducted on Reduced Mexican Crude indicated that such a correction factor or multiplier was necessary. In order to determine whether a multiplier was necessary for oils whose viscosity was equal to or less than water, tests were first conducted on Kerosene Distillate (the viscosity of which is less than water) which indicated that a multiplier was not required. A like result was obtained in measurement of Caddo Crude. However,

in case of Coastal Crude it was found that the orifice meter measurement gave results approximately 5 per cent less than tank measurement when the multiplier was not used. In the case of the Mexican Crude and Reduced Mexican Crude, greater deviations were obtained. These deviations for individual tests were plotted on a logarithmic diagram against the kinematic viscosity of the oil in question. It was found that these deviations did not vary appreciably from a mean curve drawn through the results. From this curve a multiplier was determined for use with oils of varying viscosities which multiplier or factor was afterwards applied to the results with the deviations as shown above.

In order to determine the effect of pumps on lines and relative effect due to location of pumps, approximately one-half of the tests were conducted when the flow through the line was due to gravity only, and in other cases the flow was produced by pumps at various distances from the meter, in some cases being only 10 feet away from the meter. However, in all of these cases the pumps were double acting and made only about 40 revolutions per minute. The results obtained by gravity and those obtained when pumps were used, were similar. There was no evidence of any deviation which could be attributed to the pumps. However, in the measurement of gas or any liquid it is not possible to measure a flowing liquid where pulsations are produced through the orifice by quick acting pumps.

In addition to the above tests, extensive tests covering a period of a month or more were made in which several hundred thousand barrels of Coastal Crude Oil were measured, the results of which checked with tank measurement within $3/10$ of a per cent and at the same time tests were conducted using the orifice meter for measurement of reduced Mexican Crude Oil in which the percentage deviation between tank measurement and meter measurement was varied from $3/10$ of a per cent to $1\frac{1}{2}$ per cent measuring 3800 barrels of oil.

INSTALLING AND TESTING OIL METERS

See Figures on Pages 318 and 339.

To successfully measure oil it is necessary to eliminate violent pulsation and vibration from pumps by means of air chambers or by placing the meter as far away from pumps as possible.

The preceding instructions relative to gas: **Measuring Gases and Liquids, Orifice Meter Body, Orifice Meter Flanges, Gauge Line Connections or Taps, Setting up Gauge, Differential Pen Arm, Glass, Adding Mercury, Static Pressure Connections,** (Pages 239 to 248) apply for measuring oil with the following exceptions: In measuring oil the installation may be made in any line whether level, inclined or vertical. The main line by-pass and valves may be omitted. In measuring heavy oil it is desirable to prevent the oil from entering the gauge or coming in contact with the mercury. The use of water reservoirs or seals eliminate this possibility. Figure 130 shows diagrammatically, oil installations, one where the oil line is above the gauge and the other where it is below. The reservoirs Figs. 131 and 132 should contain valves or plugs in the top for releasing the air when they are being filled with water (Page 339). The valves **RR** are placed at the middle point in the vertical height of the reservoirs and on a level with each other for purposes of determining the height of water in the reservoirs when the installation is ready to be placed in operation. Ordinary visible water gauges and glasses may be used in place of valves **RR** to indicate the level of the water in the reservoirs. The connections or pipe lines from the upstream and downstream connections to the reservoirs and the oil by-pass between the reservoirs, are $\frac{3}{4}$ inch pipe. This oil by-pass is installed so that the head of water in the reservoirs can be leveled by opening valves **B** and **Z** when valves **W** and **X** are closed. If the head of

water is higher in one reservoir than in the other, the differential reading will be affected due to the difference in densities of the water and oil. In measuring light refined oils use the simple layouts shown on Page 318.

By Pass—Install by-pass, placing valve at **Z**.

Removing Chart, Clock, Placing Chart, Pens and Ink, Vibrating Pen Arm, and Adjustments (Pages 248, 249, 250 and 258)—These articles apply with the exception that the static spring and pen arm are not necessary as the liquids are practically incompressible.

Starting Gauge—

Fill gauge and reservoirs with water.

(In measuring light oils omit reference to reservoirs and valve **B**, when using layouts, Page 318)

Open **B**, **Z**, **K** and **P**

Open valve **W** slightly to admit line pressure eliminating air at **K** and **P**. When all of air is eliminated. Open and close funnel to release air.

Close **P** and **K**

Open **W**

Open **RR** until oil flows from each valve, or if visible gauge glasses are used release the water from the petcock from the lower gauge cock until the oil occupies the upper half of the reservoir, then close the valves or petcocks.

Close **B** and **Z**

Open **X**

Leaks—Stop all leaks.

Orifice Capacities—See Page 298. For capacities see Page 332.

Checking Differential Gauge for Zero—

Close **W** and **X**

Open **K**

Open **Z**

The differential pen should return to zero.

The differential pen arm should be kept in a straight line. It can be adjusted to zero by moving slightly at the joint or at the connection with the shaft. When the pen rests at zero, determine if the float is floating and not resting on the bottom of the chamber. (See Page 247).

Close **Z** and **K**

Partially open **P**

Then open **X** carefully when the differential pen should recede one-fourth inch or more (actual measurement) below the zero line. If the float rests on the bottom of the chamber at zero, add mercury. (See Page 247).

After test close **P** and **X** and Open **Z**

Checking Differential Pen Arm—

(In measuring light oils omit reference to valve **B**, when using layouts, Page 318)

Close **W** and **X**

Attach a single column glass tube with a rubber connection and nipple at tap **P** and fasten tube in a rigid vertical position. (Page 301).

Open **K**, **Z** and **B**

Open **W** slightly and admit pressure slowly to expel air from **K**

Mark level of water in glass tube attached to connection at **P** when water seals are used.

Close **B** and **Z**

M E A S U R E M E N T O F O I L

By opening and closing **W** the reading can be checked with the column of water in the tube above the zero mark. One inch of differential reading on the chart is equal to 0.926 inches of water head above the zero mark in the water column.

This statement applies when water seals or reservoirs are used. (See Table, Page 301).

When using the layouts for measuring light oils, Page 318, the light oil will fill the glass tubing. The height that it rises above the zero setting for a certain chart reading will be equal to the water reading revised for the gravity of the oil according to the following Table.

Table 72
CHECK READINGS ON LIQUID COLUMN
IN INCHES OF LIQUID

Be. Grav- ity	Reading on Chart				Be. Grav- ity	Reading on Chart			
	10"	30"	50"	100"		10"	30"	50"	100"
30	10.7	32.0	53.4	106.9	65	13.2	39.6	66.0	131.9
35	11.0	33.1	55.2	110.5	70	13.5	40.6	67.7	135.5
40	11.4	34.2	57.0	114.1	75	13.9	41.7	69.5	139.1
45	11.8	35.3	58.8	117.7	80	14.3	42.8	71.3	142.7
50	12.1	36.4	60.6	121.2	85	14.6	43.9	73.1	146.2
55	12.5	37.4	62.4	124.8	90	15.0	44.9	74.9	149.8
60	12.8	38.5	64.2	128.4	95	15.3	46.0	76.7	153.4

In the latter case the oil may be removed from the gauge and it may be tested by filling the gauge with water, by closing **W**, **X**, and **Z**, opening **K** and adding water through the glass tubing. In this case use Table, Page 301.

MEASUREMENT OF OIL

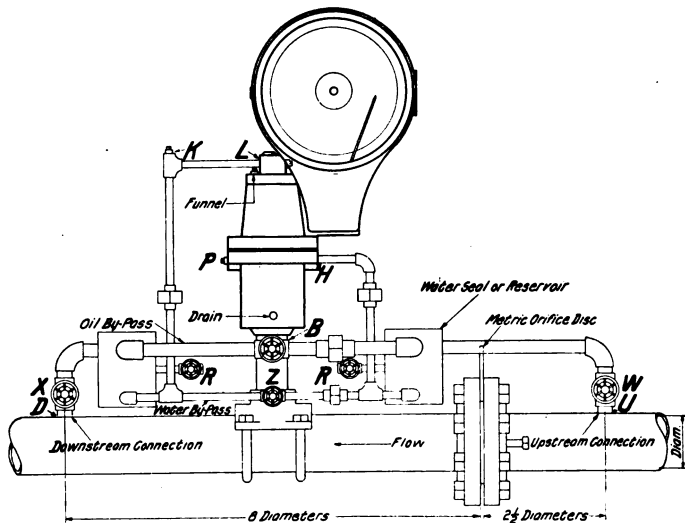

Fig. 131—50 INCH GAUGE INSTALLATION FOR MEASURING OIL

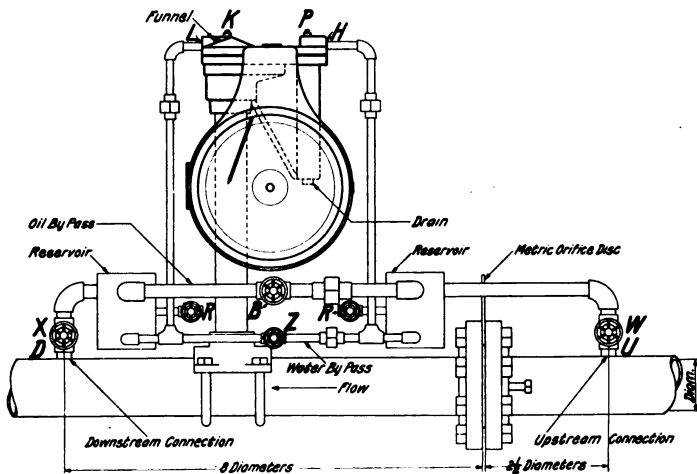

Fig. 132—50 OR 100 INCH GAUGE INSTALLATION FOR MEASURING OIL

MEASUREMENT OF OIL

READING CHARTS

The formula for use of the orifice meter is:

Quantity of liquid per hour = Coefficient $\times \sqrt{h}$,
in which h = differential pressure in inches of water.

To obtain quantity, average the differential pressure for each hour of the day. Obtain values of \sqrt{h} (differential pressure extensions) for each hour. Add these extensions together and multiply the sum by the coefficient for the orifice being used. The product will be the quantity of oil or water passing through the meter for the period during which the differential pressure is averaged.

See Page 313 for a table of Differential Pressure Extensions, (values of \sqrt{h} , 1 to 100 inches).

See Page 268, Orifice Meter Calculator.

ORIFICE METER CHART REPORT.

STATION Tank #4 DATE 6-18-21
No. A-42 Size 4X2 ORIFICE COEFF. 964.5

TIME	Differential Inches Water	Extension
12 - 1 a.m.	26	5.099
1 - 2 a.m.	27	5.196
2 - 3 a.m.	30	5.477
3 - 4 a.m.	25	5.000
4 - 5 a.m.	19	4.359
TOTAL		<u>25.131</u>
Coeff.		<u>964.5</u>
DELIVERY		<u>24,239</u>

Fig. 133—ORIFICE METER CHART REPORT FOR A PERIOD OF 5 HOURS

PART EIGHT

ORIFICE CAPACITIES

The following Tables of Hourly Capacities of Orifices give the approximate capacities for orifices at various differentials, each Table for a certain line pressure. They are based on specific gravity .6, pressure base 4 oz., base and flowing temperature 60 deg. fahr., atmospheric pressure 14.4, and are prepared for ten different pressures and four sizes of line, 40 tables for pressures taken at the flange and 40 for 2½ and 8 diameter connections. The capacities for pressures taken at the flange apply where the static pressure is obtained on the downstream side of the orifice.

Referring to Table 104 for 10 inch line, pressure 0 lb., the capacity of 2¾ inch orifice at 0 pressure, 1 inch differential is 8000 cubic feet per hour. If this size of orifice is being used in connection with a 50 inch gauge, an average reading of 1 inch is entirely too small. If the pressure remains the same it is advisable to obtain a reading at least 4 inches or greater on a 50 inch gauge at this volume of flow. A 2 inch orifice has a capacity of 8300 feet an hour at 4 inches differential, a 1¾ inch orifice would produce a differential of greater than 6 inches and a 1½ inch orifice a differential of between 10 inches and 15 inches. These Tables serve to indicate a proper size of orifice required to obtain a certain average differential for a certain hourly flow. The relative capacities of orifices where the line pressure will be approximately the same before and after changing the orifice, can be determined by using any table for the same size of line. If the pressure is 40 lb. per square inch, the 2¾ inch orifice in a 10 inch line at 2 inches differential will have the same capacity as 1¼ inch orifice in a 10 inch line at 50 inches differential.

ORIFICE CAPACITIES

If the hourly rate of flow is approximately 80,000 cu. ft. per hour for a 4 inch orifice in a 10 inch line, at average differential reading of about 20 inches at zero pressure and it is desired to reduce the flow to 20,000 feet per hour and still obtain the approximate average of 20 inches differential. By following the capacities opposite a 20 inch differential to the right, (Table 104) it is seen that the 2 inch orifice has a capacity of 18,600 cubic feet per hour at zero pressure and 20 inches differential. A $2\frac{1}{4}$ inch orifice has a capacity of 23,700 cubic feet per hour at 0 pressure and 20 inches differential. Use the 2 or $2\frac{1}{4}$, preferably a $2\frac{1}{8}$ inch. It is shown that if the same size of orifice is used, for instance, the 4 inch orifice at 20 inches differential for measuring 80,000 feet per hour the average differential for 20,000 feet per hour would be less than $1\frac{1}{2}$ inches which is entirely too low a differential for a 50 inch gauge.

The Tables also show that a gauge with a maximum differential of 10 inches has 45 per cent of the maximum capacity of a 50 inch gauge and that a 20 inch gauge has 63 per cent of the capacity of a 50 inch gauge. The maximum range of gauge to be used can be determined very quickly by inspection of a table showing the line pressure and size of line. Although these tables are prepared on a pressure base of 4 oz. and specific gravity of .6, they may be used as above indicated by remembering that the relative capacities of various orifices for various differentials are the same regardless of pressure base and specific gravity. If the specific gravity is 1.5, pressure base 3 lb., it is still true that a 4 inch orifice in a 10 inch line at 1 inch differential will have approximately the same capacity as a $1\frac{3}{4}$ inch orifice in a 10 inch line at 40 inches differential. These tables will eliminate delays in making calculations to determine the proper size of orifice to be used where orifices are to be changed on account of change of flow, change of pressure and excessively low or high differentials.

ORIFICE CAPACITIES

The following table gives the multipliers for revision of the Capacity Tables for Pressure Base and Specific Gravity.

Table 73

MULTIPLIERS FOR REVISION OF ORIFICE CAPACITY TABLES FOR GAS FOR SPECIFIC GRAVITY AND PRESSURE BASE

Pressure Base	SPECIFIC GRAVITY								
	.60	.70	.80	.90	1.00	1.10	1.20	1.30	1.40
0 oz.	1.02	.94	.88	.83	.79	.75	.72	.69	.67
4 oz.	1.00	.93	.87	.82	.78	.74	.71	.68	.66
8 oz.	.98	.91	.85	.80	.76	.73	.70	.67	.64
10 oz.	.97	.90	.84	.80	.76	.72	.69	.66	.64
1 lb.	.95	.88	.82	.78	.74	.70	.67	.65	.62
1½ lb.	.92	.85	.80	.75	.71	.68	.65	.63	.60
2 lb.	.89	.83	.77	.73	.69	.66	.63	.61	.59
3 lb.	.84	.78	.73	.69	.65	.62	.59	.57	.55



Fig. 134

ORIFICE CAPACITIES FOR GAS

Table 74
4 INCH LINE **HOURLY CAPACITIES OF ORIFICES** **PRESSURE 0 LB.**
 Specific Gravity .600 Pressure Connections at 2½ and 8 Diameters. Pressure Base 4 oz.
 Base and Flowing Temperature 60 deg. Fahr. Atmospheric Pressure 14.4 lb.
 All capacities expressed in thousands of cubic feet.

Differential in Inches of Water	Diameter of Orifice in Inches												
	½	⅝	¾	⅞	1	1¼	1½	1¾	2	2¼	2½	2¾	3
.10	.081	.128	.185	.253	.335	.54	.79	1.12	1.56	2.11	2.83	3.8	5.0
.15	.099	.156	.227	.310	.411	.66	.97	1.37	1.91	2.59	3.47	4.6	6.2
.20	.114	.181	.262	.358	.474	.76	1.12	1.58	2.20	2.98	4.01	5.4	7.1
.30	.140	.221	.320	.438	.58	.93	1.37	1.94	2.69	3.65	4.91	6.6	8.7
.40	.161	.256	.370	.51	.67	1.07	1.58	2.24	3.11	4.21	5.7	7.6	10.1
.50	.180	.286	.414	.57	.75	1.20	1.77	2.50	3.48	4.71	6.3	8.5	11.2
.60	.198	.312	.453	.62	.82	1.31	1.94	2.74	3.81	5.2	6.9	9.3	12.3
.80	.228	.361	.52	.72	.95	1.52	2.24	3.17	4.40	6.0	8.0	10.7	14.2
1	.256	.403	.58	.80	1.06	1.69	2.50	3.55	4.91	6.6	8.9	12.0	15.9
1.5	.312	.495	.72	.98	1.30	2.08	3.06	4.34	6.0	8.2	11.0	14.7	19.5
2	.361	.57	.83	1.13	1.50	2.40	3.54	5.0	7.0	9.4	12.7	16.9	22.5
3	.442	.70	1.01	1.39	1.84	2.94	4.33	6.1	8.5	11.5	15.5	20.8	27.5
4	.50	.81	1.17	1.60	2.12	3.39	5.0	7.1	9.8	13.3	17.9	24.0	31.8
6	.62	.99	1.43	1.96	2.60	4.15	6.1	8.7	12.1	16.3	21.9	29.4	38.9
8	.72	1.14	1.65	2.26	3.00	4.79	7.1	10.0	13.9	18.8	25.3	33.9	45.0
10	.81	1.28	1.85	2.53	3.35	5.4	7.9	11.2	15.6	21.1	28.3	37.9	50.
15	.99	1.56	2.27	3.10	4.11	6.6	9.7	13.7	19.1	25.9	34.7	46.5	62.
20	1.14	1.81	2.62	3.58	4.74	7.6	11.2	15.8	22.0	29.8	40.1	54.	71.
30	1.40	2.21	3.20	4.38	5.8	9.3	13.7	19.4	26.9	36.5	49.1	66.	87.
40	1.61	2.56	3.70	5.1	6.7	10.7	15.8	22.4	31.1	42.1	57.	76.	101.
50	1.80	2.86	4.14	5.7	7.5	12.0	17.7	25.0	34.8	47.1	63.	85.	112.

ORIFICE CAPACITIES FOR GAS

Table 76
4 INCH LINE HOURLY CAPACITIES OF ORIFICES PRESSURE 10 LB.
 Specific Gravity .600 Pressure Connections at 2½ and 8 Diameters. Pressure Base 4 oz.
 Base and Flowing Temperature 60 deg. Fahr. Atmospheric Pressure 14.4 lb.

All capacities expressed in thousands of cubic feet.

Differential in Inches of Water	Diameter of Orifice in Inches												
	½	⅝	¾	⅞	1	1¼	1½	1¾	2	2¼	2½	2¾	3
.10	.105	.166	.239	.329	.44	.70	1.03	1.47	2.01	2.73	3.7	4.9	6.5
.15	.129	.203	.293	.403	.53	.85	1.27	1.80	2.46	3.35	4.5	6.0	8.0
.20	.149	.235	.338	.465	.62	.98	1.46	2.08	2.84	3.86	5.2	7.0	9.2
.30	.182	.288	.414	.57	.76	1.20	1.79	2.54	3.48	4.73	6.4	8.5	11.3
.40	.211	.332	.478	.66	.87	1.39	2.07	2.93	4.02	5.5	7.3	9.9	13.0
.50	.235	.371	.53	.74	.98	1.56	2.31	3.28	4.50	6.1	8.2	11.0	14.6
.60	.259	.407	.59	.81	1.07	1.70	2.53	3.58	4.9	6.7	9.0	12.1	16.0
.80	.298	.470	.68	.93	1.23	1.97	2.92	4.15	5.7	7.7	10.4	14.0	18.4
1	.333	.52	.75	1.04	1.37	2.19	3.25	4.62	6.3	8.6	11.6	15.6	20.7
1.5	.408	.64	.93	1.27	1.69	2.69	4.04	5.7	7.8	10.6	14.2	19.1	25.2
2	.471	.74	1.07	1.47	1.95	3.11	4.62	6.6	9.0	12.2	16.4	22.1	29.1
3	.58	.91	1.31	1.80	2.39	3.81	5.7	8.0	11.0	15.0	20.1	27.0	35.7
4	.67	1.05	1.51	2.08	2.76	4.4	6.5	9.3	12.7	17.3	23.2	31.2	41.2
6	.82	1.29	1.85	2.55	3.38	5.4	8.0	11.4	15.6	21.2	28.4	38.2	50.
8	.94	1.48	2.14	2.94	3.90	6.2	9.2	13.1	18.0	24.4	32.8	44.1	58.
10	1.05	1.66	2.39	3.29	4.36	7.0	10.3	14.7	20.1	27.3	36.7	49.3	65.
15	1.29	2.03	2.93	4.03	5.3	8.5	12.7	18.0	24.6	33.5	44.9	60.	80.
20	1.49	2.35	3.38	4.65	6.2	9.8	14.6	20.8	28.4	38.6	52.	70.	92.
30	1.82	2.88	4.14	5.7	7.6	12.0	17.9	25.4	34.8	47.3	64.	85.	113.
40	2.11	3.32	4.78	6.6	8.7	13.9	20.7	29.3	40.2	55.	73.	99.	130.
50	2.35	3.71	5.3	7.4	9.8	15.6	23.1	32.8	45.0	61.	82.	110.	146.

ORIFICE CAPACITIES FOR GAS

Table 76
4 INCH LINE HOURLY CAPACITIES OF ORIFICES PRESSURE 20 LB.
 Specific Gravity .600 Pressure Connections at 2½ and 8 Diameters. Pressure Base 4 oz.
 Base and Flowing Temperature 60 deg. Fahr. Atmospheric Pressure 14.4 lb.

All capacities expressed in thousands of cubic feet.

Differential in Inches of Water	Diameter of Orifice in Inches												
	½	⅝	¾	⅞	1	1¼	1½	1¾	2	2¼	2½	2¾	3
.4	.250	.395	.57	.78	1.03	1.64	2.45	3.48	4.8	6.5	8.7	11.7	15.6
.5	.280	.441	.64	.87	1.16	1.84	2.74	3.89	5.3	7.3	9.8	13.0	17.4
.6	.307	.483	.70	.96	1.27	2.01	3.00	4.26	5.9	8.0	10.7	14.3	19.1
.8	.354	.56	.80	1.11	1.46	2.33	3.46	4.92	6.8	9.2	12.3	16.5	22.0
1	.40	.62	.90	1.23	1.63	2.60	3.87	5.5	7.6	10.3	13.8	18.4	24.5
1.5	.49	.76	1.10	1.51	2.00	3.18	4.74	6.7	9.3	12.6	16.9	22.6	30.1
2	.56	.88	1.27	1.75	2.31	3.68	5.5	7.8	10.7	14.6	19.5	26.1	34.8
3	.69	1.08	1.56	2.14	2.83	4.50	6.7	9.5	13.1	17.8	23.9	32.0	42.6
4	.79	1.25	1.80	2.47	3.27	5.1	7.7	11.0	15.1	20.6	27.6	36.9	49.2
6	.97	1.53	2.20	3.03	4.00	6.4	9.5	13.5	18.5	25.2	33.8	45.2	60.
8	1.12	1.76	2.55	3.50	4.62	7.4	10.9	15.6	21.4	29.1	39.0	52.	70.
10	1.25	1.97	2.85	3.91	5.2	8.2	12.2	17.4	23.9	32.6	43.6	58.	78.
15	1.53	2.42	3.49	4.79	6.3	10.1	15.0	21.3	29.3	39.9	53.	71.	95.
20	1.77	2.79	4.02	5.5	7.3	11.6	17.3	24.6	33.8	46.1	62.	83.	110.
30	2.17	3.42	4.93	6.8	9.0	14.2	21.2	30.1	41.4	56.	76.	100.	135.
40	2.50	3.95	5.7	7.8	10.3	16.4	24.5	34.8	48.	65.	87.	117.	156.
50	2.80	4.41	6.4	8.7	11.6	18.4	27.4	38.9	53.	73.	98.	130.	174.
60	3.07	4.83	7.0	9.6	12.7	20.1	30.0	42.6	59.	80.	107.	143.	191.
80	3.54	5.6	8.0	11.1	14.6	23.3	34.6	49.2	68.	92.	123.	165.	220.
100	3.96	6.2	9.0	12.3	16.3	26.0	38.7	55.	76.	103.	138.	184.	245.

ORIFICE CAPACITIES FOR GAS

Table 77
4 INCH LINE HOURLY CAPACITIES OF ORIFICES PRESSURE 40 LB.
 Specific Gravity .600 Pressure Connections at 2½ and 8 Diameters. Pressure Base 4 oz.
 Base and Flowing Temperature 60 deg. Fahr. Atmospheric Pressure 14.4 lb.
 All capacities expressed in thousands of cubic feet.

Differential in Inches of Water	Diameter of Orifice in Inches												
	½	⅝	¾	⅞	1	1¼	1½	1¾	2	2¼	2½	2¾	3
1	.50	.78	1.13	1.56	2.05	3.28	4.9	6.9	9.5	12.9	17.4	23.2	30.8
1.5	.61	.96	1.38	1.91	2.52	4.00	6.0	8.5	11.7	15.9	21.3	28.4	37.8
2	.71	1.11	1.60	2.21	2.91	4.62	6.9	9.8	13.5	18.3	24.6	32.8	43.7
3	.87	1.36	1.96	2.70	3.57	5.7	8.5	12.0	16.5	22.5	30.1	40.2	54.
4	1.00	1.57	2.26	3.12	4.12	6.5	9.8	13.8	19.1	25.9	34.8	46.4	62.
6	1.22	1.92	2.77	3.82	5.0	8.0	12.0	16.9	23.4	31.7	42.6	57.	76.
8	1.41	2.22	3.20	4.41	5.8	9.2	13.8	19.5	27.0	36.7	49.2	66.	87.
10	1.58	2.48	3.57	4.92	6.5	10.3	15.4	21.8	30.2	41.0	55.	73.	98.
15	1.94	3.04	4.38	6.0	8.0	12.7	18.9	26.7	36.9	50.	67.	90.	120.
20	2.24	3.51	5.1	7.0	9.2	14.6	21.8	30.9	42.7	58.	78.	104.	138.
30	2.74	4.29	6.6	8.5	11.3	17.9	26.9	37.8	52.	71.	95.	127.	169.
40	3.16	4.96	7.1	9.9	13.0	20.7	30.8	43.6	60.	82.	110.	147.	195.
50	3.54	5.5	8.0	11.0	14.6	23.1	34.5	48.8	67.	92.	123.	164.	218.
60	3.87	6.1	8.8	12.1	16.0	25.3	37.8	53.	74.	100.	135.	180.	239.
80	4.47	7.0	10.1	14.0	18.4	29.2	43.6	62.	85.	116.	156.	208.	276.
100	4.98	7.8	11.3	15.6	20.5	32.8	48.6	69.	95.	129.	174.	232.	308.

Table 78
4 INCH LINE HOURLY CAPACITIES OF ORIFICES PRESSURE 60 LB.
 Specific Gravity .600 Pressure Connections at 2½ and 8 Diameters. Pressure Base 4 oz.
 Base and Flowing Temperature 60 deg. Fahr. Atmospheric Pressure 14.4 lb.
 All capacities expressed in thousands of cubic feet.

Differential in Inches of Water	Diameter of Orifice in Inches												
	½	5/8	¾	7/8	1	1¼	1½	1¾	2	2¼	2½	2¾	3
1	.58	.91	1.32	1.81	2.39	3.8	5.6	8.0	11.1	15.1	20.3	27.1	36.
1.5	.71	1.12	1.62	2.22	2.94	4.7	7.0	9.9	13.7	18.6	25.0	33.4	44.
2	.82	1.30	1.87	2.57	3.39	5.4	8.1	11.4	15.8	21.4	28.8	38.5	51.
3	1.00	1.59	2.29	3.14	4.16	6.7	9.9	14.0	19.4	26.2	35.3	47.2	62.
4	1.16	1.84	2.64	3.63	4.80	7.7	11.4	16.2	22.4	30.3	40.8	54.	72.
6	1.42	2.25	3.23	4.45	5.9	9.4	14.0	19.8	27.4	37.1	50.	67.	88.
8	1.64	2.60	3.73	5.1	6.8	10.9	16.1	22.9	31.7	42.9	58.	77.	102.
10	1.83	2.90	4.17	5.7	7.6	12.1	18.0	25.6	35.4	47.9	65.	86.	114.
15	2.25	3.56	5.1	7.0	9.3	14.9	22.1	31.3	43.4	59.	79.	106.	139.
20	2.59	4.11	5.9	8.1	10.7	17.2	25.5	36.1	50.	68.	91.	122.	161.
30	3.18	5.0	7.2	9.9	13.1	21.0	31.2	44.3	61.	83.	112.	149.	197.
40	3.67	5.8	8.3	11.5	15.2	24.3	36.1	51.	71.	96.	129.	172.	228.
50	4.10	6.5	9.3	12.8	17.0	27.2	40.3	57.	79.	107.	144.	193.	255.
60	4.49	7.1	10.2	14.1	18.6	29.7	44.2	63.	87.	117.	158.	211.	279.
80	5.2	8.2	11.8	16.2	21.5	34.3	51.	72.	100.	136.	182.	244.	322.
100	5.8	9.1	13.2	18.1	23.9	38.3	56.	80.	111.	151.	203.	271.	360.

ORIFICE CAPACITIES FOR GAS

Table 79
4 INCH LINE HOURLY CAPACITIES OF ORIFICES PRESSURE 100 LB.
 Specific Gravity .600 Pressure Connections at 2½ and 8 Diameters. Pressure Base 4 oz.
 Base and Flowing Temperature 60 deg. Fahr. Atmospheric Pressure 14.4 lb.
 All capacities expressed in thousands of cubic feet.

Differential in Inches of Water	Diameter of Orifice in Inches												
	½	⅕	¼	⅜	1	1¼	1½	1¾	2	2¼	2½	2¾	3
1	.72	1.13	1.64	2.25	2.97	4.7	7.1	10.0	13.8	18.7	25.2	33.7	45.
1.5	.88	1.40	2.02	2.77	3.64	5.8	8.7	12.2	16.9	23.0	30.9	41.1	55.
2	1.02	1.61	2.33	3.20	4.21	6.7	10.0	14.1	19.5	26.5	35.7	47.5	63.
3	1.25	1.97	2.86	3.91	5.2	8.2	12.2	17.3	23.9	32.5	43.7	58.	78.
4	1.44	2.28	3.30	4.52	5.9	9.5	14.1	20.0	27.6	37.5	50.	67.	90.
6	1.77	2.79	4.04	5.5	7.3	11.7	17.3	24.4	33.8	45.9	62.	82.	110.
8	2.04	3.22	4.67	6.4	8.4	13.5	20.0	28.2	39.0	53.	71.	95.	127.
10	2.28	3.61	5.2	7.1	9.4	15.1	22.4	31.6	43.6	59.	80.	106.	142.
15	2.79	4.42	6.4	8.8	11.5	18.4	27.4	38.7	53.	73.	98.	130.	174.
20	3.22	5.1	7.4	10.1	13.3	21.3	31.6	44.7	62.	84.	113.	150.	200.
30	3.95	6.2	9.0	12.4	16.3	26.1	38.7	55.	76.	103.	138.	184.	245.
40	4.56	7.2	10.4	14.3	18.8	30.1	44.7	63.	87.	119.	160.	213.	283.
50	5.1	8.1	11.7	16.0	21.0	33.7	50.	71.	98.	113.	179.	238.	317.
60	5.6	8.8	12.8	17.5	23.0	36.9	55.	77.	107.	145.	196.	260.	347.
80	6.4	10.2	14.8	20.2	26.6	42.6	63.	89.	123.	168.	226.	301.	401.
100	7.2	11.3	16.4	22.5	29.7	47.0	71.	100.	138.	187.	252.	337.	447.

Table 80
4 INCH LINE HOURLY CAPACITIES OF ORIFICES PRESSURE 150 LB.
 Specific Gravity .600 Pressure Connections at 2½ and 8 Diameters. Pressure Base 4 oz.
 Base and Flowing Temperature 60 deg. fahr. Atmospheric Pressure 14.4 lb.
 All capacities expressed in thousands of cubic feet.

Differential in Inches of Water	Diameter of Orifice in Inches												
	½	⅝	¾	7/8	1	1¼	1½	1¾	2	2¼	2½	2¾	3
1	.86	1.36	1.97	2.70	3.6	5.7	8.4	12.0	16.5	22.4	30.1	40.	53.
1.5	1.06	1.66	2.41	3.31	4.4	7.0	10.4	14.2	20.2	27.4	37.1	49.	66.
2	1.22	1.92	2.78	3.82	5.1	8.1	12.0	16.9	23.3	31.4	42.9	57.	76.
3	1.50	2.35	3.40	4.68	6.2	9.9	14.7	20.7	28.6	38.8	52.	70.	93.
4	1.73	2.71	3.93	5.3	7.1	11.4	17.0	24.0	33.0	44.8	60.	81.	107.
6	2.12	3.32	4.81	6.6	8.7	14.0	20.8	29.3	40.4	55.	74.	99.	131.
8	2.44	3.84	5.6	7.6	10.1	16.1	24.0	33.9	46.7	63.	86.	114.	151.
10	2.73	4.29	6.2	8.5	11.3	18.0	26.8	37.9	52.	71.	96.	128.	169.
15	3.35	5.3	7.6	10.5	13.8	22.1	32.8	46.4	64.	87.	117.	156.	207.
20	3.86	6.1	8.8	12.1	16.0	25.5	37.9	53.	74.	100.	136.	181.	239.
30	4.73	7.4	10.8	14.8	19.6	31.2	46.4	65.	90.	123.	166.	221.	293.
40	5.5	8.6	12.4	17.1	22.6	36.1	54.	75.	104.	142.	192.	256.	338.
50	6.1	9.6	13.9	19.1	25.2	40.3	60.	84.	117.	158.	214.	286.	378.
60	6.7	10.5	15.2	20.9	27.7	44.2	66.	92.	128.	174.	235.	312.	414.
80	7.7	12.1	17.6	24.1	31.9	51.	76.	109.	148.	200.	271.	361.	479.
100	8.6	13.6	19.7	27.0	35.6	57.	84.	120.	165.	224.	301.	403.	530.

ORIFICE CAPACITIES FOR GAS

Table 81
4 INCH LINE HOURLY CAPACITIES OF ORIFICES PRESSURE 200 LB.
 Specific Gravity .600 Pressure Connections at 2½ and 3 Diameters. Pressure Base 4 oz.
 Base and Flowing Temperature 60 deg. Fahr. Atmospheric Pressure 14.4 lb.
 All capacities expressed in thousands of cubic feet.

Differential in Inches of Water	Diameter of Orifice in Inches												
	½	⅝	¾	⅞	1	1¼	1½	1¾	2	2¼	2½	2¾	3
1	.99	1.55	2.25	3.08	4.1	6.5	9.7	13.7	18.9	25.6	34.4	46.	61.
1.5	1.21	1.91	2.77	3.78	5.0	8.0	11.8	16.8	23.1	31.2	42.3	56.	75.
2	1.40	2.21	3.20	4.37	5.8	9.2	13.6	19.3	26.7	36.1	48.8	65.	87.
3	1.71	2.70	3.91	5.4	7.1	11.3	16.7	23.7	32.7	44.2	60.	80.	106.
4	1.98	3.12	4.52	6.2	8.2	13.1	19.3	27.4	37.8	50.	69.	92.	122.
6	2.42	3.82	5.5	7.6	10.0	16.0	23.6	33.5	46.3	62.	85.	113.	150.
8	2.80	4.41	6.4	8.7	11.5	18.5	27.2	38.7	53.	72.	98.	130.	173.
10	3.13	4.93	7.7	9.8	12.9	20.7	30.5	43.3	60.	81.	109.	145.	194.
15	3.83	6.0	8.8	12.0	15.8	25.3	37.3	53.	73.	99.	134.	178.	237.
20	4.43	7.0	10.1	13.8	18.2	29.2	43.1	62.	85.	114.	154.	206.	274.
30	5.4	8.5	12.4	16.9	22.3	35.8	53.	76.	104.	140.	189.	252.	335.
40	6.3	9.9	14.3	19.5	25.8	41.4	61.	87.	120.	161.	218.	291.	387.
50	7.0	11.0	16.0	21.8	28.8	46.2	68.	98.	134.	180.	244.	325.	433.
60	7.7	12.1	17.5	23.9	31.6	51.	75.	107.	146.	198.	267.	356.	474.
80	8.9	14.0	20.2	27.6	36.5	58.	86.	123.	169.	228.	309.	411.	500.
100	9.9	15.5	22.5	30.8	40.7	65.	97.	137.	189.	256.	344.	461.	610.

Table 82
4 INCH LINE HOURLY CAPACITIES OF ORIFICES PRESSURE 300 LB.
 Specific Gravity .600 Pressure Connections at 2½ and 8 Diameters. Pressure Base 4 oz.
 Base and Flowing Temperature 60 deg. Fahr. Atmospheric Pressure 14.4 lb.

All capacities expressed in thousands of cubic feet.

Differential in Inches of Water	Diameter of Orifice in Inches												
	½	⅝	¾	7⁄8	1	1¼	1½	1¾	2	2¼	2½	2¾	3
1	1.19	1.88	2.72	3.7	4.9	7.9	11.7	16.6	22.9	31.0	42.	55.	74.
1.5	1.42	2.30	3.34	4.6	6.0	9.7	14.3	20.4	28.2	38.2	51.	69.	91.
2	1.69	2.65	3.85	5.3	7.0	11.2	16.5	23.5	32.5	44.1	59.	79.	105.
3	2.08	3.25	4.72	6.5	8.5	13.7	20.3	28.8	39.8	54.	72.	97.	129.
4	2.40	3.75	5.4	7.5	9.8	15.8	23.4	33.3	46.0	62.	83.	112.	148.
6	2.94	4.59	6.7	9.2	12.1	19.4	28.7	40.8	56.	76.	102.	137.	182.
8	3.39	5.3	7.7	10.6	13.9	22.4	33.1	47.1	65.	88.	118.	158.	210.
10	3.80	5.9	8.6	11.9	15.6	25.0	37.0	53.	73.	99.	132.	177.	235.
15	4.64	7.3	10.6	14.5	19.1	30.6	45.3	64.	89.	121.	161.	217.	287.
20	5.4	8.4	12.2	16.8	22.0	35.4	52.	74.	103.	140.	186.	250.	332.
30	6.6	10.3	14.9	20.5	26.9	43.3	64.	91.	126.	171.	228.	307.	406.
40	7.6	11.9	17.2	23.7	31.1	50.	74.	105.	145.	197.	263.	354.	469.
50	8.5	13.3	19.3	26.5	34.8	56.	83.	118.	163.	229.	294.	396.	520.
60	9.3	14.5	21.1	29.0	38.1	61.	91.	129.	178.	242.	322.	434.	570.
80	10.7	16.8	24.4	33.5	44.0	71.	105.	149.	206.	279.	372.	500.	660.
100	11.9	18.8	27.2	37.4	49.3	79.	117.	166.	229.	310.	420.	550.	740.

Table 83
4 INCH LINE HOURLY CAPACITIES OF ORIFICES PRESSURE 400 LB.
 Specific Gravity .600 Pressure Connections at 1½ and 8 Diameters. Pressure Base 4 oz.
 Base and Flowing Temperature 60 deg. Fahr. Atmospheric Pressure 14.4 lb.
 All capacities expressed in thousands of cubic feet.

Differential in Inches of Water	Diameter of Orifice in Inches												
	½	5/8	¾	7/8	1	1¼	1½	1¾	2	2¼	2½	2¾	3
1	1.37	2.15	3.12	4.3	5.7	9.1	13.4	19.0	26.3	36.	48.	64.	85.
1.5	1.68	2.64	3.82	5.2	6.9	11.1	16.5	23.3	32.2	44.	59.	79.	104.
2	1.93	3.05	4.41	6.1	8.0	12.9	19.0	26.9	37.1	51.	68.	91.	120.
3	2.37	3.74	5.4	7.4	9.8	15.7	23.3	33.0	45.5	62.	83.	111.	147.
4	2.74	4.32	6.2	8.6	11.3	18.2	26.9	38.1	52.	71.	96.	128.	170.
6	3.35	5.3	7.6	10.5	13.8	22.3	32.9	46.7	64.	87.	118.	157.	208.
8	3.87	6.1	8.8	12.1	16.0	25.7	38.0	54.	74.	101.	136.	182.	240.
10	4.33	6.8	9.9	13.5	17.9	28.7	42.5	60.	83.	113.	152.	203.	268.
15	5.3	8.4	12.1	16.6	21.9	35.2	52.	74.	102.	138.	182.	249.	328.
20	6.1	9.7	14.0	19.1	25.3	40.7	60.	85.	117.	160.	215.	287.	379.
30	7.5	11.8	17.1	23.4	30.9	49.8	74.	104.	144.	196.	263.	352.	464.
40	8.7	13.7	19.7	27.1	35.7	57.	85.	120.	166.	226.	304.	406.	540.
50	9.7	15.3	22.1	30.3	40.0	64.	95.	135.	186.	252.	339.	454.	600.
60	10.6	16.7	24.2	33.2	43.8	70.	104.	148.	203.	277.	372.	497.	660.
80	12.2	19.3	27.9	38.3	51.	81.	120.	170.	235.	319.	429.	570.	760.
100	13.7	21.5	31.2	42.9	57.	91.	134.	190.	263.	360.	479.	640.	850.

Table 84
6 INCH LINE HOURLY CAPACITIES OF ORIFICES
 Specific Gravity .600 Pressure Connections at 3½ and 8 Diameters. **PRESSURE 0 LB.**
 Base and Flowing Temperature 60 deg. Fahr. Atmospheric Pressure 14.4 lb.
 Pressure Base 4 oz.

All capacities expressed in thousands of cubic feet.

Differential in Inches of Water	Diameter of Orifice in Inches												
	¾	1	1¼	1½	1¾	2	2¼	2½	2¾	3	3½	4	4½
.10	.182	.326	.51	.75	1.03	1.38	1.79	2.26	2.83	3.48	5.2	7.7	11.2
.15	.223	.399	.63	.92	1.27	1.69	2.19	2.77	3.47	4.26	6.4	9.4	13.7
.20	.257	.461	.72	1.06	1.46	1.95	2.53	3.19	4.01	4.92	7.4	10.8	15.8
.30	.315	.56	.89	1.30	1.79	2.39	3.09	3.91	4.91	6.0	9.0	13.3	19.4
.40	.364	.65	1.02	1.51	2.07	2.76	3.57	4.52	5.7	7.0	10.4	15.3	22.4
.50	.407	.73	1.15	1.68	2.31	3.08	4.00	5.0	6.3	7.8	11.7	17.1	25.0
.60	.445	.80	1.25	1.84	2.53	3.38	4.38	5.5	6.9	8.5	12.8	18.7	27.4
.80	.51	.92	1.45	2.13	2.92	3.90	5.1	6.4	8.0	9.8	14.8	21.6	31.7
1	.58	1.03	1.62	2.37	3.27	4.35	5.6	7.1	8.9	11.0	16.5	24.3	35.4
1.5	.70	1.26	1.98	2.91	4.00	5.3	6.9	8.7	11.0	13.5	20.2	29.6	43.4
2	.81	1.46	2.29	3.37	4.62	6.2	8.0	10.1	12.7	15.6	23.3	34.2	50.1
3	1.00	1.78	2.81	4.12	5.7	7.6	9.8	12.4	15.5	19.1	28.6	41.9	61.
4	1.15	2.06	3.24	4.76	6.5	8.7	11.3	14.3	17.9	22.0	33.0	48.4	71.
6	1.41	2.52	3.97	5.8	8.0	10.7	13.8	17.5	21.9	26.9	40.4	59.	87.
8	1.63	2.91	4.58	6.7	9.2	12.3	16.0	20.2	25.3	31.1	46.7	68.	100.
10	1.82	3.26	5.1	7.5	10.3	13.8	17.9	22.6	28.3	34.8	52.	77.	112.
15	2.23	3.99	6.3	9.2	12.7	16.9	21.9	27.7	34.7	42.6	64.	94.	137.
20	2.57	4.61	7.2	10.6	14.6	19.5	25.3	31.9	40.1	49.2	74.	108.	158.
30	3.15	5.6	8.9	13.0	17.9	23.6	30.9	39.1	49.1	60.	90.	133.	194.
40	3.64	6.5	10.2	15.1	20.7	27.6	35.7	45.2	57.	70.	104.	153.	224.
50	4.07	7.3	11.5	16.8	23.1	30.8	40.0	50.	63.	78.	117.	171.	250.

ORIFICE CAPACITIES FOR GAS

Table 85
6 INCH LINE HOURLY CAPACITIES OF ORIFICES PRESSURE 10 LB.
 Specific Gravity .600 Pressure Connections at 2½ and 3 Diameters. Pressure Base 4 oz.
 Base and Flowing Temperature 60 deg. Fahr. Atmospheric Pressure 14.4 lb.
 All capacities expressed in thousands of cubic feet.

Differential in Inches of Water	Diameter of Orifice in Inches												
	¾	1	1¼	1½	1¾	2	2¼	2½	2¾	3	3½	4	4½
.10	.237	.43	.67	.98	1.34	1.79	2.32	2.93	3.7	4.5	6.8	10.1	14.5
.15	.290	.52	.82	1.20	1.64	2.19	2.85	3.59	4.5	5.5	8.3	12.3	17.8
.20	.335	.60	.95	1.38	1.90	2.53	3.29	4.15	5.2	6.4	9.6	14.2	20.6
.30	.410	.74	1.16	1.69	2.32	3.09	4.03	5.1	6.4	7.8	11.7	17.4	25.2
.40	.474	.85	1.34	1.95	2.68	3.57	4.65	5.9	7.3	9.0	13.5	20.1	29.1
.50	.53	.95	1.50	2.18	3.00	4.00	5.2	6.6	8.2	10.1	15.1	22.5	32.5
.60	.58	1.04	1.64	2.39	3.28	4.38	5.7	7.2	9.0	11.1	16.6	24.6	35.6
.80	.67	1.20	1.90	2.76	3.79	5.1	6.6	8.3	10.4	12.8	19.1	28.4	41.1
1	.75	1.34	2.11	3.09	4.26	5.7	7.3	9.3	11.6	14.3	21.4	31.6	46.1
1.5	.92	1.65	2.60	3.78	5.2	6.9	9.0	11.4	14.2	17.5	26.2	38.9	56
2	1.06	1.90	3.00	4.37	6.0	8.0	10.4	13.1	16.4	20.2	30.3	45.0	65.
3	1.30	2.33	3.67	5.4	7.3	9.8	12.7	16.1	20.1	24.7	37.1	55.	80.
4	1.50	2.69	4.24	6.2	8.5	11.3	14.7	18.5	23.2	28.6	42.8	64.	92.
6	1.83	3.29	5.2	7.6	10.4	13.8	18.0	22.7	28.4	35.0	52.	78.	113.
8	2.12	3.80	6.0	8.7	12.0	16.0	20.8	26.2	32.8	40.4	61.	90.	130.
10	2.37	4.25	6.7	9.8	13.4	17.9	23.2	29.3	36.7	45.2	68.	101.	145.
15	2.90	5.2	8.2	12.0	16.4	21.9	28.5	35.9	44.9	55.	83.	123.	178.
20	3.35	6.0	9.5	13.8	19.0	25.3	32.9	41.5	52.	64.	96.	142.	206.
30	4.10	7.4	11.6	16.9	23.2	30.9	40.3	51.	64.	78.	117.	174.	252.
40	4.74	8.5	13.4	19.5	26.8	35.7	46.5	59.	73.	90.	135.	201.	291.
50	5.3	9.5	15.0	21.8	30.0	40.0	52.	66.	82.	101.	151.	225.	325.

Table 86
6 INCH LINE HOURLY CAPACITIES OF ORIFICES PRESSURE 20 LB.
 Specific Gravity .600 Pressure Connections at 2½ and 8 Diameters. Pressure Base 4 oz.
 Base and Flowing Temperature 60 deg. Fahr. Atmospheric Pressure 14.4 lb.

All capacities expressed in thousands of cubic feet.

Differential in Inches of Water	Diameter of Orifice in Inches												
	¾	1	1¼	1½	1¾	2	2¼	2½	2¾	3	3½	4	4½
.4	.57	1.01	1.60	2.31	3.19	4.2	5.5	7.0	8.7	10.7	16.1	23.7	34.5
.5	.63	1.12	1.79	2.59	3.57	4.7	6.2	7.8	9.8	12.0	18.0	26.5	38.5
.6	.69	1.23	1.96	2.84	3.91	5.2	6.8	8.5	10.7	13.1	19.8	29.0	42.2
.8	.80	1.42	2.26	3.27	4.52	6.0	7.8	9.8	12.3	15.2	22.8	33.5	48.7
1	.89	1.59	2.51	3.66	5.1	6.7	8.7	11.0	13.8	17.0	25.5	37.6	55.
1.5	1.10	1.95	3.09	4.48	6.2	8.2	10.7	13.5	16.9	20.8	31.2	38.9	67.
2	1.27	2.25	3.57	5.2	7.1	9.5	12.3	15.6	19.5	24.0	36.1	53.	77.
3	1.55	2.75	4.37	6.3	8.7	11.6	15.1	19.1	23.9	29.4	44.2	65.	94.
4	1.79	3.18	5.0	7.3	10.1	13.4	17.4	22.0	27.6	33.9	50.	75.	109.
6	2.19	3.89	6.2	9.0	12.4	16.5	21.4	26.9	33.8	41.5	62.	92.	133.
8	2.53	4.50	7.1	10.4	14.3	19.0	24.7	31.1	39.0	47.9	72.	106.	154.
10	2.83	5.0	8.0	11.6	16.0	21.3	27.6	34.8	43.6	54.	81.	119.	172.
15	3.47	6.2	9.8	14.2	19.6	26.0	33.8	42.6	53.	66.	99.	145.	211.
20	4.01	7.1	11.3	16.4	22.6	30.1	39.0	49.2	62.	76.	114.	168.	244.
30	4.91	8.7	13.8	20.0	27.7	36.8	47.8	60.	76.	93.	140.	205.	299.
40	5.7	10.1	16.0	23.1	31.9	42.5	55.	70.	87.	107.	161.	237.	345.
50	6.3	11.2	17.9	25.9	35.7	47.5	62.	78.	98.	120.	180.	265.	385.
60	6.9	12.3	19.6	28.4	39.1	52.	68.	85.	107.	131.	198.	290.	422.
80	8.0	14.2	22.6	32.7	45.2	60.	78.	98.	123.	152.	228.	335.	487.
100	8.9	15.9	25.1	36.6	51.	67.	87.	110.	138.	170.	255.	376.	550.

Table 87
6 INCH LINE HOURLY CAPACITIES OF ORIFICES PRESSURE 40 LB.
 Specific Gravity .600 Pressure Connections at 2½ and 8 Diameters. Pressure Base 4 oz.
 Base and Flowing Temperature 60 deg. Fahr. Atmospheric Pressure 14.4 lb.
 All capacities expressed in thousands of cubic feet.

Differential in Inches of Water	Diameter of Orifice in Inches												
	¾	1	1¼	1½	1¾	2	2¼	2½	2¾	3	3½	4	4½
1	1.12	2.00	3.16	4.6	6.4	8.5	10.9	13.8	17.3	21.4	32.0	47.	69.
1.5	1.37	2.44	3.86	5.6	7.8	10.4	13.3	16.9	21.3	26.2	39.3	58.	85.
2	1.58	2.82	4.46	6.5	9.0	12.0	15.4	19.5	24.6	30.3	45.4	67.	98.
3	1.94	3.46	5.5	8.0	11.0	14.7	18.9	23.9	30.1	37.1	56.	82.	120.
4	2.24	4.00	6.3	9.2	12.7	17.0	21.8	27.6	34.8	42.8	64.	94.	138.
6	2.74	4.89	7.7	11.3	15.6	20.8	26.7	33.8	42.6	52.	79.	116.	169.
8	3.17	5.6	8.9	13.0	18.0	24.0	30.8	39.0	49.2	61.	91.	134.	195.
10	3.53	6.3	10.0	14.5	20.1	26.8	34.5	43.6	55.	68.	102.	149.	218.
15	4.39	7.7	12.2	17.8	24.6	32.8	42.2	53.	67.	83.	124.	183.	267.
20	5.0	8.9	14.1	20.6	28.4	37.9	48.7	62.	78.	96.	144.	211.	309.
30	6.1	10.9	17.3	25.2	34.8	46.4	60.	76.	95.	117.	176.	259.	378.
40	7.1	12.6	19.9	29.1	40.2	54.	69.	87.	110.	135.	203.	299.	436.
50	7.9	14.1	22.3	32.5	45.0	60.	77.	98.	123.	151.	227.	334.	488.
60	8.7	15.4	24.4	35.6	49.3	66.	84.	107.	135.	166.	249.	366.	530.
80	10.0	17.8	28.2	41.1	57.	76.	97.	123.	156.	191.	287.	422.	620.
100	11.2	20.0	31.6	46.1	64.	85.	109.	138.	173.	214.	320.	470.	690.

ORIFICE CAPACITIES FOR GAS

Table 88
6 INCH LINE HOURLY CAPACITIES OF ORIFICES PRESSURE 60 LB.
 Specific Gravity .600 Pressure Connections at 2½ and 8 Diameters. Pressure Base 4 oz.
 Base and Flowing Temperature 60 deg. Fahr. Atmospheric Pressure 14.4 lb.
 All capacities expressed in thousands of cubic feet.

Differential in Inches of Water	Diameter of Orifice in Inches												
	¾	1	1¼	1½	1¾	2	2¼	2½	2¾	3	3½	4	4½
1	1.31	2.34	3.70	5.4	7.5	9.9	12.8	16.2	20.2	25.0	38.	55.	81.
1.5	1.60	2.87	4.52	6.6	9.1	12.1	15.6	19.8	24.7	30.6	46.	67.	99.
2	1.85	3.31	5.2	7.6	10.5	14.0	18.0	22.9	28.6	35.3	53.	78.	114.
3	2.27	4.05	6.4	9.4	12.9	17.0	22.0	28.1	35.0	43.3	65.	95.	140.
4	2.62	4.68	7.4	10.8	14.8	19.8	25.4	32.4	40.4	50.	75.	110.	162.
6	3.20	5.7	9.0	13.2	18.2	24.2	31.2	39.7	49.5	61.	92.	135.	198.
8	3.70	6.6	10.4	15.3	21.0	28.0	36.0	45.8	57.	70.	106.	156.	229.
10	4.14	7.4	11.7	17.1	23.5	31.3	40.2	51.	64.	79.	119.	174.	256.
15	5.1	9.1	14.3	20.9	28.7	38.3	49.3	63.	78.	96.	145.	213.	313.
20	5.8	10.9	16.5	24.1	33.2	44.	57.	72.	90.	111.	168.	246.	361.
30	7.2	12.8	20.2	29.6	40.6	54.	70.	89.	110.	136.	205.	301.	443.
40	8.3	14.8	23.3	34.2	46.9	63.	80.	102.	128.	158.	237.	348.	510.
50	9.2	16.5	26.1	38.2	52.	70.	90.	115.	143.	176.	265.	389.	570.
60	10.1	18.1	28.6	41.8	57.	77.	99.	125.	156.	195.	290.	426.	630.
80	11.7	20.9	33.0	48.3	66.	89.	114.	145.	181.	223.	335.	492.	720.
100	13.1	23.4	37.0	54.	75.	99.	128.	162.	202.	250.	375.	550.	810.

ORIFICE CAPACITIES FOR GAS

Table 89
6 INCH LINE HOURLY CAPACITIES OF ORIFICES PRESSURE 100 LB.
 Specific Gravity .600 Pressure Connections at 2½ and 8 Diameters. Pressure Base 4 oz.
 Base and Flowing Temperature 60 deg. Fahr. Atmospheric Pressure 14.4 lb.
 All capacities expressed in thousands of cubic feet.

Differential in Inches of Water	Diameter of Orifice in Inches											
	¾	1	1¼	1½	1¾	2	2¼	2½	3	3½	4	4½
1	1.63	2.9	4.7	6.7	9.2	12.2	15.8	20.0	25.1	31.0	37.0	43.0
1.5	2.00	3.6	5.6	8.2	11.4	15.0	19.5	24.4	30.9	38.2	46.0	54.0
2	2.31	4.1	6.5	9.5	13.1	17.3	22.5	28.2	35.7	44.1	53.0	62.0
3	2.83	5.0	8.0	11.6	16.1	21.2	27.5	34.6	43.7	54.0	65.0	76.0
4	3.27	5.8	9.2	13.4	18.5	24.5	31.8	40.0	50.0	62.0	75.0	88.0
6	4.00	7.1	11.3	16.5	22.7	30.0	38.9	48.9	62.0	76.0	92.0	108.0
8	4.60	8.2	13.0	19.0	26.2	34.6	45.0	56.5	71.0	88.0	108.0	128.0
10	5.2	9.2	14.5	21.3	29.3	38.7	50.0	63.0	80.0	99.0	121.0	144.0
15	6.3	11.2	17.8	26.0	35.9	47.4	62.0	77.0	98.0	121.0	148.0	176.0
20	7.3	13.0	20.6	30.1	41.5	55.0	71.0	89.0	113.0	140.0	172.0	208.0
30	9.0	15.9	25.2	36.8	51.0	67.0	87.0	109.0	138.0	171.0	212.0	254.0
40	10.3	18.3	29.1	42.5	59.0	77.0	101.0	126.0	160.0	197.0	243.0	293.0
50	11.6	20.5	32.5	47.5	66.0	87.0	112.0	141.0	179.0	228.0	284.0	344.0
60	12.7	22.5	35.6	52.0	72.0	95.0	123.0	154.0	196.0	242.0	300.0	360.0
80	14.6	25.9	41.1	60.0	83.0	109.0	142.0	178.0	226.0	279.0	345.0	415.0
100	16.3	29.1	46.9	67.0	92.0	122.0	158.0	200.0	251.0	310.0	380.0	470.0

Table 90
6 INCH LINE HOURLY CAPACITIES OF ORIFICES PRESSURE 150 LB.
 Specific Gravity .600 Pressure Connections at 2½ and 8 Diameters. Pressure Base 4 oz.
 Base and Flowing Temperature 60 deg. Fahr. Atmospheric Pressure 14.4 lb.
 All capacities expressed in thousands of cubic feet.

Differential in Inches of Water	Diameter of Orifice in Inches												
	¾	1	1¼	1½	1¾	2	2¼	2½	2¾	3	3½	4	4½
1	1.95	3.5	5.5	8.0	11.0	14.7	19.0	24.0	30.1	37.	56.	82.	119.
1.5	2.39	4.3	6.7	9.7	13.6	18.1	23.3	29.4	36.7	46.	68.	101.	147.
2	2.76	4.9	7.8	11.3	15.7	20.9	26.9	33.9	42.4	53.	78.	117.	169.
3	3.38	6.0	9.5	13.8	19.2	25.6	33.0	41.6	51.	64.	96.	143.	207.
4	3.90	7.0	11.0	16.0	22.2	29.5	38.1	48.0	60.	74.	111.	165.	240.
6	4.78	8.5	13.5	19.5	27.2	36.1	46.7	59.	73.	91.	136.	202.	293.
8	5.5	9.8	15.6	22.6	31.4	41.7	54.	68.	84.	105.	157.	233.	339.
10	6.2	11.0	17.4	25.2	35.1	46.7	60.	76.	94.	118.	176.	261.	379.
15	7.6	13.5	21.3	30.9	43.0	57.	74.	93.	116.	144.	215.	319.	464.
20	8.7	15.6	24.6	35.7	49.6	66.	85.	107.	134.	166.	248.	369.	540.
30	10.7	19.1	30.1	43.8	61.	81.	104.	131.	164.	240.	304.	451.	660.
40	12.3	22.0	34.8	50.	70.	93.	120.	152.	189.	235.	351.	520.	760.
50	13.8	24.6	38.9	56.	78.	104.	135.	170.	212.	263.	392.	580.	850.
60	15.1	27.0	42.6	62.	86.	114.	148.	186.	232.	288.	430.	640.	930.
80	17.4	31.1	49.2	71.	99.	132.	170.	215.	268.	333.	496.	740.	1070.
100	19.5	34.9	55.	80.	110.	147.	190.	240.	301.	372.	560.	820.	1190.

Table 91
6 INCH LINE HOURLY CAPACITIES OF ORIFICES PRESSURE 200 LB.
 Specific Gravity .600 Pressure Connections at 2½ and 8 Diameters. Pressure Base 4 oz.
 Base and Flowing Temperature 60 deg. Fahr. Atmospheric Pressure 14.4 lb.
 All capacities expressed in thousands of cubic feet.

Differential in Inches of Water	Diameter of Orifice in Inches												
	¾	1	1¼	1½	1¾	2	2¼	2½	2¾	3	3½	4	4½
1	2.23	3.98	6.3	9.2	12.6	16.8	21.7	27.5	34.4	42.	64.	94.	137.
1.5	2.74	4.89	7.7	11.2	15.4	20.6	26.7	33.7	42.3	52.	78.	115.	168.
2	3.17	5.6	8.9	13.0	17.8	23.8	30.8	38.9	48.8	60.	90.	132.	193.
3	3.88	6.9	10.9	15.9	21.8	29.1	37.8	47.6	60.	73.	110.	162.	237.
4	4.48	8.0	12.6	18.4	25.2	33.6	43.6	55.	69.	85.	127.	187.	274.
6	5.5	9.2	15.4	22.5	30.9	41.1	53.	67.	85.	104.	156.	229.	335.
8	6.3	11.3	17.8	26.0	35.6	47.5	62.	78.	98.	120.	180.	265.	387.
10	7.1	12.6	19.7	29.0	39.8	53.	69.	87.	109.	134.	201.	296.	433.
15	8.7	15.4	24.4	35.6	48.8	65.	84.	107.	134.	164.	246.	363.	530.
20	10.0	17.8	28.2	41.1	56.	75.	97.	123.	154.	190.	284.	419.	610.
30	12.3	21.9	34.5	50.	69.	92.	119.	151.	189.	232.	348.	510.	750.
40	14.2	25.2	39.8	58.	80.	106.	138.	174.	218.	268.	402.	590.	870.
50	15.8	28.2	44.6	65.	89.	119.	154.	194.	244.	300.	450.	660.	970.
60	17.4	30.9	48.8	71.	98.	130.	169.	213.	267.	328.	483.	730.	1060.
80	20.0	35.7	56.	82.	113.	150.	195.	246.	309.	379.	570.	850.	1220.
100	22.3	39.8	63.	92.	126.	168.	217.	275.	344.	425.	640.	940.	1370.

Table 92
6 INCH LINE HOURLY CAPACITIES OF ORIFICES PRESSURE 300 LB.
 Specific Gravity .600 Pressure Connections at 2½ and 3 Diameters. Pressure Base 4 oz.
 Base and Flowing Temperature 60 deg. Fahr. Atmospheric Pressure 14.4 lb.

All capacities expressed in thousands of cubic feet.

Differential in Inches of Water	Diameter of Orifice in Inches												
	¾	1	1¼	1½	1¾	2	2¼	2½	2¾	3	3½	4	4½
1	2.70	4.8	7.6	11.0	15.3	20.3	26.3	33.3	42.	51.	77.	114.	165.
1.5	3.31	5.9	9.3	13.5	18.7	25.0	32.2	40.8	51.	63.	94.	140.	202.
2	3.82	6.8	10.8	15.6	21.6	28.8	37.1	47.1	59.	73.	109.	161.	233.
3	4.68	8.3	13.2	19.1	26.5	35.3	45.5	58.	72.	89.	133.	197.	286.
4	5.3	9.6	15.3	22.0	30.6	40.8	52.	67.	83.	103.	154.	228.	330.
6	6.6	11.8	18.7	26.9	37.5	50.	64.	82.	102.	126.	189.	279.	404.
8	7.6	13.6	21.6	31.1	43.3	58.	74.	94.	118.	146.	218.	322.	467.
10	8.5	15.2	24.1	34.8	48.4	65.	83.	105.	132.	163.	243.	361.	520.
15	10.5	18.6	29.6	42.6	59.	79.	102.	129.	161.	199.	298.	442.	640.
20	12.1	21.5	34.1	49.2	68.	91.	117.	149.	186.	230.	344.	510.	740.
30	14.8	26.3	41.8	60.	84.	112.	144.	182.	228.	282.	422.	620.	900.
40	17.1	30.4	48.3	70.	97.	129.	166.	211.	263.	326.	487.	720.	1040.
50	19.1	33.9	54.	78.	108.	144.	186.	235.	294.	364.	540.	810.	1170.
60	20.9	37.2	59.	85.	119.	158.	203.	259.	322.	399.	600.	880.	1280.
80	24.1	42.9	68.	98.	137.	182.	235.	298.	372.	461.	690.	1020.	1480.
100	27.0	48.2	76.	110.	153.	203.	263.	333.	416.	510.	770.	1140.	1650.

Table 93
6 INCH LINE HOURLY CAPACITIES OF ORIFICES PRESSURE 400 LB.
 Specific Gravity .600 Pressure Connections at 2½ and 3 Diameters. Pressure Base 4 oz.
 Base and Flowing Temperature 60 deg. Fahr. Atmospheric Pressure 14.4 lb.

All capacities expressed in thousands of cubic feet.

Differential in Inches of Water	Diameter of Orifice in Inches												
	¾	1	1¼	1½	1¾	2	2¼	2½	2¾	3	3½	4	4½
1	3.10	5.5	8.7	12.7	17.5	23.3	30.1	38.	48.	59.	89.	130.	190.
1.5	3.78	6.8	10.7	15.6	21.5	28.7	36.7	47.	59.	72.	109.	160.	233.
2	4.37	7.8	12.3	18.0	24.8	33.1	42.4	54.	68.	83.	126.	185.	269.
3	5.4	9.6	15.1	22.0	30.4	40.5	51.	66.	83.	102.	154.	227.	330.
4	6.2	11.1	17.4	25.4	35.1	46.8	60.	76.	96.	118.	178.	262.	381.
6	7.6	13.6	21.4	31.2	43.0	57.	73.	93.	118.	145.	218.	320.	467.
8	8.7	15.7	24.7	36.0	49.6	66.	85.	108.	136.	167.	251.	370.	540.
10	9.8	17.6	27.6	40.2	55.	74.	95.	120.	152.	187.	281.	414.	600.
15	12.0	21.5	33.8	49.3	68.	91.	116.	148.	186.	229.	344.	510.	740.
20	13.8	24.8	39.0	57.	78.	105.	134.	170.	215.	264.	397.	580.	850.
30	16.9	30.4	47.8	70.	96.	128.	164.	209.	263.	323.	486.	720.	1040.
40	19.5	35.1	55.	80.	111.	148.	189.	241.	304.	373.	560.	830.	1200.
50	21.8	39.2	62.	90.	124.	165.	212.	269.	334.	417.	630.	920.	1350.
60	23.9	43.0	68.	99.	136.	181.	232.	295.	372.	457.	690.	1010.	1480.
80	27.6	49.6	78.	114.	157.	209.	268.	341.	429.	530.	790.	1170.	1700.
100	31.0	55.	87.	127.	175.	233.	301.	382.	480.	590.	890.	1300.	1900.

ORIFICE CAPACITIES FOR GAS

Table 94
8 INCH LINE HOURLY CAPACITIES OF ORIFICES
PRESSURE 0 LB.
 Specific Gravity .600 Pressure Connections at 2½ and 8 Diameters. Pressure Base 4 oz.
 Base and Flowing Temperature 60 deg. Fahr. Atmospheric Pressure 14.4 lb.
 All capacities expressed in thousands of cubic feet.

Differential in Inches of Water	Diameter of Orifice in Inches														
	1	1¼	1½	1¾	2	2¼	2½	2¾	3	3½	4	4½	5	5½	6
.10	.323	.50	.74	1.02	1.33	1.71	2.13	2.61	3.76	4.5	6.2	8.4	11.3	15.1	19.7
.15	.395	.62	.91	1.24	1.63	2.09	2.60	3.19	3.87	5.5	7.6	10.3	13.8	18.4	24.4
.20	.456	.71	1.05	1.44	1.88	2.41	3.01	3.69	4.48	6.4	8.8	11.9	16.0	21.3	28.2
.30	.56	.87	1.28	1.76	2.30	2.96	3.68	4.51	5.5	7.8	10.8	14.5	19.6	26.1	34.5
.40	.65	1.01	1.48	2.03	2.66	3.42	4.25	5.2	6.3	9.0	12.4	16.8	22.6	30.1	39.8
.50	.72	1.12	1.65	2.27	2.97	3.82	4.75	5.8	7.1	10.1	13.9	18.7	25.2	33.7	44.6
.60	.79	1.23	1.81	2.49	3.25	4.18	5.2	6.4	7.7	11.1	15.2	20.5	27.7	36.9	48.8
.80	.91	1.42	2.09	2.87	3.76	4.83	6.0	7.4	8.9	12.8	17.6	23.7	31.9	42.6	56.
1	1.02	1.60	2.33	3.20	4.2	5.4	6.7	8.3	10.0	14.2	19.5	26.5	35.6	47.7	63.
1.5	1.25	1.97	2.87	3.93	5.1	6.6	8.2	10.1	12.2	17.5	24.1	32.5	43.7	58.	77.
2	1.44	2.27	3.31	4.54	5.9	7.6	9.5	11.7	14.1	20.2	27.8	37.5	51.	67.	89.
3	1.77	2.78	4.05	5.6	7.3	9.4	11.6	14.3	17.3	24.7	34.0	45.9	62.	82.	109.
4	2.04	3.21	4.68	6.4	8.4	10.8	13.4	16.5	20.0	28.6	39.3	52.	71.	95.	126.
6	2.50	3.93	5.7	7.9	10.3	13.2	16.5	20.2	24.4	35.0	48.1	65.	87.	117.	154.
8	2.88	4.54	6.6	9.1	11.9	15.3	19.0	23.3	28.2	40.4	56.	75.	101.	135.	178.
10	3.23	5.0	7.4	10.2	13.3	17.1	21.3	26.1	37.6	45.2	62.	84.	113.	151.	197.
15	3.95	6.2	9.1	12.4	16.3	20.9	26.0	31.9	38.7	55.	76.	103.	138.	184.	244.
20	4.56	7.1	10.5	14.4	18.8	24.1	30.1	36.9	44.8	64.	88.	119.	160.	213.	282.
30	5.6	8.7	12.8	17.6	23.0	29.6	36.8	45.1	55.	78.	108.	145.	196.	261.	345.
40	6.5	10.1	14.8	20.3	26.6	34.2	42.5	52.	63.	90.	124.	168.	226.	301.	398.
50	7.2	11.2	16.5	22.7	29.7	38.2	47.5	58.	71.	101.	139.	187.	252.	337.	446.

ORIFICE CAPACITIES FOR GAS

Table 95
8 INCH LINE HOURLY CAPACITIES OF ORIFICES PRESSURE 10 LB.
 Specific Gravity .600 Pressure Connections at 2½ and 8 Diameters. Pressure Base 4 oz.
 Base and Flowing Temperature 60 deg. Fahr. Atmospheric Pressure 14.4 lb.
 All capacities expressed in thousands of cubic feet.

Differential in Inches of Water	Diameter of Orifice in Inches														
	1	1¼	1½	1¾	2	2¼	2½	2¾	3	3½	4	4½	5	5½	6
.10	.42	.66	.96	1.32	1.72	2.21	2.78	3.42	4.1	5.8	8.1	10.9	14.7	19.5	26.1
.15	.52	.81	1.17	1.61	2.11	2.71	3.41	4.18	5.1	7.1	9.9	13.4	18.0	23.9	31.9
.20	.60	.94	1.36	1.86	2.44	3.13	3.94	4.83	5.8	8.3	11.4	15.4	20.8	27.9	36.9
.30	.73	1.15	1.66	2.28	2.99	3.84	4.82	5.9	7.2	10.0	14.0	18.9	25.4	33.8	45.1
.40	.84	1.33	1.92	2.63	3.45	4.42	5.6	6.8	8.3	11.7	16.1	21.8	29.3	39.1	52.
.50	.94	1.48	2.14	2.94	3.85	4.94	6.2	7.6	9.2	13.0	18.0	24.4	32.8	43.7	58.
.60	1.03	1.63	2.35	3.22	4.22	5.4	6.8	8.4	10.1	14.3	19.8	26.7	35.9	47.9	64.
.80	1.19	1.88	2.71	3.72	4.87	6.3	7.9	9.7	10.7	16.5	22.8	30.9	41.5	55.	74.
1	1.33	2.09	3.04	4.16	5.5	7.0	8.8	10.7	13.0	18.5	25.5	34.6	46.4	62.	82.
1.5	1.63	2.57	3.71	5.1	6.7	8.6	10.8	13.2	16.0	22.6	31.2	42.3	57.	76.	101.
2	1.88	2.97	4.29	5.9	7.7	9.8	12.4	15.3	18.5	26.1	36.1	48.8	66.	87.	117.
3	2.31	3.64	5.2	7.2	9.4	12.1	15.2	18.7	22.7	32.0	44.2	60.	80.	107.	143.
4	2.66	4.20	6.0	8.3	10.9	14.0	17.6	21.6	26.2	36.9	50.	69.	93.	124.	165.
6	3.26	5.1	7.4	10.2	13.3	17.1	21.6	26.5	32.0	45.2	62.	85.	114.	151.	202.
8	3.77	5.9	8.6	11.8	15.4	19.7	24.9	30.5	37.0	52.	72.	98.	131.	175.	233.
10	4.21	6.6	9.6	13.2	17.2	22.1	27.8	34.2	41.4	58.	81.	109.	147.	195.	261.
15	5.2	8.1	11.7	16.1	21.1	27.1	34.1	41.8	51.	71.	99.	134.	180.	239.	319.
20	6.0	9.4	13.6	18.6	24.4	31.3	39.4	48.3	58.	83.	114.	154.	208.	279.	369.
30	7.3	11.5	16.6	22.8	29.9	38.4	48.2	59.	72.	100.	140.	189.	254.	338.	451.
40	8.4	13.3	19.2	26.3	34.5	44.2	56.	68.	83.	117.	161.	218.	293.	391.	520.
50	9.4	14.8	21.4	29.4	38.5	49.4	62.	76.	92.	130.	180.	244.	328.	437.	580.

ORIFICE CAPACITIES FOR GAS

Table 96
8 INCH LINE HOURLY CAPACITIES OF ORIFICES PRESSURE 20 LB.
 Specific Gravity 600 Pressure Connections at 2½ and 3 Diameters. Pressure Base 4 oz.
 Base and Flowing Temperature 60 deg. Fahr. Atmospheric Pressure 14.4 lb.
 All capacities expressed in thousands of cubic feet.

Differential in Inches of Water	Diameter of Orifice in Inches														
	1	1¼	1½	1¾	2	2¼	2½	2¾	3	3½	4	4½	5	5½	6
.4	1.01	1.57	2.28	3.14	4.14	5.3	6.6	8.1	9.8	13.9	19.2	26.1	34.8	47.	62.
.5	1.12	1.75	2.55	3.51	4.62	5.9	7.4	9.1	10.9	15.6	21.4	29.1	38.9	52.	69.
.6	1.23	1.92	2.79	3.84	5.1	6.4	8.1	9.9	12.0	17.0	23.5	31.9	42.6	57.	76.
.8	1.42	2.22	3.22	4.44	5.8	7.4	9.3	11.5	13.8	19.7	27.1	36.9	49.2	66.	88.
1	1.58	2.48	3.60	4.94	6.5	8.3	10.4	12.7	15.4	21.9	30.2	41.0	55.	74.	98.
1.5	1.95	3.04	4.41	6.1	8.0	10.2	12.7	15.7	18.9	26.9	37.1	50.	67.	90.	120.
2	2.25	3.51	5.1	7.0	9.2	11.8	14.7	18.2	21.8	31.1	42.9	58.	78.	104.	139.
3	2.75	4.30	6.2	8.6	11.3	14.4	18.0	22.2	26.8	38.1	52.	71.	95.	127.	170.
4	3.18	4.96	7.2	9.9	13.1	16.6	20.8	25.7	30.8	44.0	60.	82.	110.	147.	196.
6	3.89	6.1	8.8	12.1	16.0	20.4	25.5	31.4	37.8	54.	74.	101.	135.	180.	240.
8	4.50	7.0	10.2	14.0	18.5	23.5	29.4	36.3	43.7	62.	86.	117.	156.	208.	277.
10	5.0	7.8	11.4	15.7	20.7	26.3	32.9	40.6	48.9	70.	96.	130.	174.	232.	310.
15	6.2	9.6	13.9	19.2	25.3	32.2	40.3	49.7	60.	85.	117.	160.	213.	285.	380.
20	7.1	11.1	16.1	22.2	29.2	37.2	46.5	57.	69.	98.	136.	184.	246.	329.	439.
30	8.7	13.6	19.7	27.2	35.8	45.6	57.	70.	85.	120.	166.	226.	301.	403.	540.
40	10.1	15.7	22.8	31.4	41.4	53.	66.	81.	98.	139.	192.	261.	348.	465.	620.
50	11.2	17.5	25.5	35.1	46.2	59.	74.	91.	109.	156.	214.	291.	389.	520.	690.
60	12.3	19.2	27.9	38.4	51.	64.	81.	99.	120.	170.	235.	319.	426.	570.	760.
80	14.2	22.2	32.2	44.4	58.	74.	93.	115.	138.	197.	271.	369.	492.	660.	880.
100	15.8	24.8	36.0	49.4	65.	83.	104.	127.	154.	219.	302.	410.	550.	740.	980.

Table 97
8 INCH LINE HOURLY CAPACITIES OF ORIFICES PRESSURE 40 LB.
 Specific Gravity .600 Pressure Connections at 2½ and 8 Diameters. Pressure Base 4 oz.
 Base and Flowing Temperature 60 deg. Fahr. Atmospheric Pressure 14.4 lb.
 All capacities expressed in thousands of cubic feet.

Differential in Inches of Water	Diameter of Orifice in Inches														
	1	1¼	1½	1¾	2	2¼	2½	2¾	3	3½	4	4½	5	5½	6
1	1.99	3.13	4.5	6.2	8.2	10.5	13.1	16.1	19.4	27.6	38.	52.	69.	93.	123.
1.5	2.44	3.82	5.5	7.6	10.0	12.9	16.0	19.7	23.9	33.7	47.	63.	85.	114.	150.
2	2.82	4.41	6.4	8.8	11.5	14.8	18.5	22.7	27.6	38.9	54.	73.	98.	131.	173.
3	3.46	5.4	7.8	10.8	14.1	18.2	22.7	27.8	33.8	47.6	66.	89.	120.	161.	212.
4	3.99	6.2	9.0	12.5	16.3	21.0	26.2	32.1	39.0	55.	76.	103.	138.	185.	245.
6	4.89	7.6	11.1	15.3	20.0	25.7	32.0	39.3	47.8	67.	93.	126.	169.	227.	300.
8	5.6	8.8	12.8	17.6	23.1	27.7	37.0	45.4	55.	78.	108.	146.	195.	262.	346.
10	6.3	9.9	14.3	19.7	25.8	33.2	41.4	51.	62.	87.	120.	163.	218.	293.	387.
15	7.8	12.1	17.5	24.2	31.6	40.7	51.	62.	76.	107.	148.	199.	267.	359.	474.
20	8.9	14.0	20.2	27.9	36.5	47.0	58.	72.	87.	123.	170.	230.	309.	415.	550.
30	10.9	17.1	24.8	34.2	44.7	58.	72.	88.	107.	151.	209.	282.	378.	510.	670.
40	12.9	19.7	28.6	39.5	52.	66.	83.	102.	123.	174.	241.	326.	436.	590.	770.
50	14.1	22.1	32.0	44.1	58.	74.	92.	113.	138.	194.	269.	364.	488.	660.	870.
60	15.5	24.2	35.0	48.3	63.	81.	101.	124.	151.	213.	295.	399.	530.	720.	950.
80	17.8	27.9	40.4	56.	73.	94.	117.	144.	174.	246.	341.	461.	620.	830.	1090.
100	19.9	31.3	45.3	62.	82.	105.	131.	161.	194.	276.	380.	520.	690.	930.	1230.

Table 98
8 INCH LINE HOURLY CAPACITIES OF ORIFICES PRESSURE 60 LB.
 Specific Gravity .600 Pressure Connections at 2½ and 8 Diameters. Pressure Base 4 oz.
 Base and Flowing Temperature 60 deg. Fahr. Atmospheric Pressure 14.4 lb.

Differential in Inches of Water	Diameter of Orifice in Inches														
	1	1¼	1½	1¾	2	2¼	2½	2¾	3	3½	4	4½	5	5½	6
1	2.33	3.7	5.3	7.3	9.6	12.2	15.3	18.8	22.7	32.3	45.	60.	81.	108.	143.
1.5	2.84	4.5	6.5	8.9	11.7	15.0	18.7	23.0	27.9	39.7	54.	74.	99.	132.	176.
2	3.28	5.2	7.5	10.3	13.5	17.3	21.6	26.5	32.2	45.8	63.	86.	114.	153.	204.
3	4.02	6.3	9.2	12.6	16.5	21.2	26.5	32.5	39.5	56.	77.	105.	140.	187.	249.
4	4.64	7.3	10.6	14.6	19.1	24.5	30.6	37.5	45.6	65.	89.	121.	162.	216.	288.
6	5.7	9.0	13.0	17.8	23.4	30.0	37.5	45.9	56.	79.	109.	148.	198.	265.	353.
8	6.6	10.4	15.0	20.6	27.0	34.6	43.3	53.	64.	92.	126.	171.	229.	305.	407.
10	7.3	11.6	16.8	23.0	30.2	38.7	48.4	59.	72.	102.	140.	192.	256.	342.	455.
15	9.0	14.2	20.5	28.2	36.9	47.4	59.	73.	88.	125.	172.	235.	313.	418.	560.
20	10.4	16.4	23.7	32.6	42.7	55.	68.	84.	102.	145.	199.	271.	361.	483.	640.
30	12.7	20.0	29.0	39.9	52.	67.	84.	103.	125.	177.	243.	332.	443.	590.	790.
40	14.7	23.1	33.5	46.0	60.	77.	93.	119.	144.	200.	281.	383.	510.	680.	910.
50	16.4	25.9	37.5	51.	67.	87.	108.	133.	161.	229.	314.	429.	570.	760.	1020.
60	18.0	28.4	41.1	56.	74.	95.	119.	145.	177.	251.	344.	469.	630.	840.	1120.
80	20.8	32.7	47.4	65.	85.	109.	137.	168.	204.	290.	397.	540.	720.	970.	1290.
100	23.3	36.6	53.	73.	96.	122.	153.	188.	227.	323.	446.	600.	810.	1080.	1430.

Table 99
8 INCH LINE HOURLY CAPACITIES OF ORIFICES PRESSURE 100 LB.
 Specific Gravity .600 Pressure Connections at 2½ and 8 Diameters. Pressure Base 4 oz.
 Base and Flowing Temperature 60 deg. Fahr. Atmospheric Pressure 14.4 lb.

All capacities expressed in thousands of cubic feet.

Differential in Inches of Water	Diameter of Orifice in Inches														
	1	1¼	1½	1¾	2	2¼	2½	2¾	3	3½	4	4½	5	5½	6
1	2.9	4.5	6.6	9.0	11.9	15.2	19.0	23.3	28.2	40.	55.	75.	101.	135.	178.
1.5	3.6	5.5	8.1	11.0	14.6	18.7	23.3	28.7	34.6	49.	67.	92.	124.	165.	219.
2	4.1	6.4	9.3	12.0	16.8	21.6	26.9	33.1	39.9	56.	78.	106.	143.	190.	252.
3	5.0	7.8	11.4	15.0	20.6	26.5	33.0	40.5	48.9	69.	95.	130.	175.	233.	309.
4	5.8	9.0	13.2	18.0	23.8	30.6	38.1	46.8	56.	80.	110.	150.	202.	269.	357.
6	7.1	11.1	16.2	22.0	29.1	37.5	46.7	57.	69.	97.	135.	183.	247.	329.	437.
8	8.2	12.8	18.7	25.0	33.7	43.3	54.	66.	80.	113.	156.	212.	286.	380.	500.
10	9.2	14.3	20.9	28.4	37.6	48.4	60.	74.	89.	126.	174.	237.	319.	425.	560.
15	11.2	17.5	25.6	34.8	46.1	59.	74.	91.	109.	154.	213.	290.	391.	520.	690.
20	13.0	20.2	29.5	40.2	53.	68.	85.	105.	126.	178.	246.	335.	452.	600.	800.
30	15.9	24.8	36.1	49.2	65.	84.	104.	128.	155.	219.	301.	410.	550.	740.	980.
40	18.3	28.6	41.7	57.	75.	97.	120.	148.	179.	252.	348.	474.	640.	850.	1130.
50	20.5	32.0	46.7	64.	84.	108.	135.	165.	200.	282.	389.	530.	710.	950.	1260.
60	22.5	35.0	51.	70.	92.	119.	148.	181.	219.	310.	426.	580.	780.	1040.	1380.
80	25.9	40.4	59.	80.	106.	137.	170.	209.	253.	358.	492.	670.	900.	1200.	1600.
100	28.9	45.4	66.	90.	119.	152.	190.	233.	282.	400.	550.	750.	1010.	1350.	1780.

Table 100
8 INCH LINE HOURLY CAPACITIES OF ORIFICES PRESSURE 150 LB.
 Specific Gravity .600 Pressure Connections at 2½ and 3 Diameters. Pressure Base 4 oz.
 Base and Flowing Temperature 60 deg. Fahr. Atmospheric Pressure 14.4 lb.

All capacities expressed in thousands of cubic feet.

Differential in Inches of Water	Diameter of Orifice in Inches														
	1	1¼	1½	1¾	2	2¼	2½	2¾	3	3½	4	4½	5	5½	6
1	3.5	5.4	7.9	10.8	14.2	18.3	22.8	28.0	34.	48.	66.	90.	120.	161.	214.
1.5	4.2	6.7	9.7	13.2	17.5	22.4	27.9	34.3	42.	59.	81.	110.	142.	197.	262.
2	4.9	7.7	11.2	15.3	20.2	25.9	32.2	39.6	48.	68.	93.	127.	170.	227.	303.
3	6.0	9.4	13.7	18.7	24.7	31.7	39.5	48.5	59.	83.	114.	155.	208.	278.	371.
4	6.9	10.9	15.8	21.6	28.6	36.6	45.6	56.	68.	96.	132.	180.	240.	321.	428.
6	8.5	13.3	19.4	26.5	35.0	44.8	56.	69.	83.	118.	162.	220.	293.	393.	520.
8	9.8	15.4	22.4	30.5	40.4	52.	64.	79.	96.	136.	187.	254.	339.	454.	610.
10	10.9	17.2	25.0	34.2	45.2	58.	72.	89.	107.	152.	209.	284.	379.	510.	680.
15	13.4	21.1	30.6	41.8	55.	71.	88.	108.	131.	186.	256.	348.	464.	620.	830.
20	15.4	24.4	35.4	48.3	64.	82.	102.	125.	152.	215.	295.	402.	540.	720.	960.
30	18.9	29.9	43.3	59.	78.	100.	125.	153.	186.	263.	361.	492.	660.	890.	1170.
40	21.8	34.5	50.	68.	90.	116.	144.	177.	214.	304.	417.	570.	750.	1020.	1350.
50	24.4	38.5	56.	76.	101.	129.	161.	198.	240.	339.	467.	640.	850.	1130.	1510.
60	26.7	42.2	61.	84.	111.	142.	177.	217.	263.	372.	510.	700.	930.	1240.	1660.
80	30.9	48.7	71.	97.	128.	164.	204.	250.	303.	429.	590.	800.	1070.	1440.	1910.
100	34.6	54.	79.	108.	142.	183.	228.	280.	338.	480.	660.	900.	1200.	1610.	2140.

Table 101
8 INCH LINE HOURLY CAPACITIES OF ORIFICES PRESSURE 200 LB.
 Specific Gravity .600 Pressure Connections at 2½ and 8 Diameters. Pressure Base 4 oz.
 Base and Flowing Temperature 60 deg. Fahr. Atmospheric Pressure 14.4 lb.
 All capacities expressed in thousands of cubic feet.

Differential in Inches of Water	Diameter of Orifice in Inches														
	1	1¼	1½	1¾	2	2¼	2½	2¾	3	3½	4	4½	5	5½	6
1	4.0	6.2	9.0	12.4	16.3	20.8	26.0	32.	39.	55.	76.	102.	138.	184.	244.
1.5	4.9	7.6	11.0	15.1	19.8	25.5	31.8	39.	47.	67.	93.	125.	169.	226.	299.
2	5.6	8.8	12.7	17.5	22.9	29.4	36.8	45.	55.	78.	107.	144.	195.	261.	345.
3	6.9	10.8	15.5	21.4	28.1	36.0	45.0	55.	67.	95.	131.	177.	239.	320.	423.
4	7.9	12.5	18.0	24.7	32.4	41.6	51.	64.	77.	110.	151.	204.	276.	369.	488.
6	9.7	15.3	22.0	30.3	39.7	51.	64.	78.	95.	135.	185.	250.	338.	452.	600.
8	11.2	17.6	25.4	35.0	45.8	59.	74.	90.	109.	156.	214.	288.	390.	520.	690.
10	12.5	19.7	28.4	39.1	51.	66.	82.	101.	122.	174.	239.	323.	436.	580.	770.
15	15.3	24.2	34.8	47.9	63.	81.	101.	123.	150.	213.	293.	395.	530.	710.	950.
20	17.7	27.9	40.2	55.	72.	93.	116.	142.	173.	246.	338.	456.	620.	830.	1090.
30	21.7	34.2	49.2	68.	89.	114.	142.	174.	212.	301.	414.	560.	760.	1000.	1340.
40	25.0	39.5	57.	78.	102.	132.	164.	201.	245.	348.	478.	650.	870.	1170.	1540.
50	28.0	44.1	64.	87.	115.	147.	184.	225.	274.	389.	530.	720.	980.	1300.	1730.
60	30.7	48.3	70.	96.	125.	161.	201.	246.	300.	426.	590.	790.	1070.	1430.	1890.
80	35.4	56.	80.	111.	145.	186.	233.	284.	346.	492.	680.	910.	1230.	1650.	2180.
100	39.5	62.	90.	124.	163.	208.	260.	319.	386.	550.	760.	1020.	1380.	1840.	2440.

Table 102
8 INCH LINE HOURLY CAPACITIES OF ORIFICES PRESSURE 300 LB.
 Specific Gravity .600 Pressure Connections at 2½ and 8 Diameters. Pressure Base 4 oz.
 Base and Flowing Temperature 60 deg. Fahr. Atmospheric Pressure 14.4 lb.
 All capacities expressed in thousands of cubic feet.

Differential in Inches of Water	Diameter of Orifice in Inches														
	1	1¼	1½	1¾	2	2¼	2½	2¾	3	3½	4	4¾	5	5½	6
1	4.8	7.5	10.9	15.0	19.7	25.2	31.5	39.	47.	66.	92.	124.	167.	223.	295.
1.5	5.9	9.2	13.3	18.3	24.1	30.9	38.6	47.	57.	82.	112.	153.	204.	272.	361.
2	6.8	10.6	15.4	21.2	27.8	35.7	44.6	55.	66.	94.	130.	176.	235.	314.	417.
3	8.3	13.0	18.9	25.9	34.0	43.7	55.	67.	81.	115.	159.	216.	288.	385.	510.
4	9.6	15.0	21.8	30.0	39.3	50.	63.	77.	94.	133.	184.	250.	333.	444.	519.
6	11.8	18.3	26.7	36.7	48.1	62.	77.	95.	115.	163.	225.	306.	408.	540.	720.
8	13.6	21.2	30.8	42.4	56.	71.	89.	109.	132.	188.	260.	353.	471.	630.	850.
10	15.2	23.7	34.5	47.4	62.	80.	100.	122.	148.	211.	290.	395.	530.	700.	930.
15	18.6	29.0	42.2	58.	76.	98.	122.	150.	181.	259.	356.	483.	640.	860.	1140.
20	21.5	33.5	48.7	67.	88.	113.	141.	173.	209.	298.	411.	560.	740.	990.	1320.
30	26.3	41.0	60.	82.	108.	138.	173.	212.	256.	365.	500.	680.	910.	1220.	1620.
40	30.4	47.4	69.	94.	124.	160.	199.	245.	296.	421.	580.	790.	1050.	1400.	1870.
50	33.9	53.	77.	106.	139.	179.	223.	274.	331.	471.	650.	880.	1180.	1570.	2090.
60	37.2	58.	84.	116.	152.	196.	244.	300.	363.	520.	710.	970.	1290.	1720.	2290.
80	42.9	67.	97.	134.	176.	226.	282.	346.	419.	600.	820.	1120.	1490.	1990.	2640.
100	48.0	75.	109.	150.	197.	252.	315.	386.	467.	660.	920.	1240.	1670.	2230.	2950.

Table 103
8 INCH LINE HOURLY CAPACITIES OF ORIFICES PRESSURE 400 LB.
 Specific Gravity .600 Pressure Connections at 2½ and 8 Diameters. Pressure Base 4 oz.
 Base and Flowing Temperature 60 deg. Fahr. Atmospheric Pressure 14.4 lb.
 All capacities expressed in thousands of cubic feet.

Differential in Inches of Water	Diameter of Orifice in Inches														
	1	1¼	1½	1¾	2	2¼	2½	2¾	3	3½	4	4½	5	5½	6
1	5.5	8.6	12.5	17.2	22.6	29.0	36.	44.	54.	76.	105.	142.	191.	255.	339.
1.5	6.7	10.6	15.3	20.9	27.7	35.5	45.	54.	66.	93.	129.	175.	235.	312.	415.
2	7.8	12.2	17.6	24.2	32.0	41.0	51.	63.	76.	108.	148.	202.	271.	361.	479.
3	9.5	15.0	21.6	29.6	39.1	50.	63.	77.	93.	132.	182.	247.	333.	442.	590.
4	11.0	17.3	25.0	34.2	45.2	58.	73.	89.	107.	153.	210.	286.	384.	500.	680.
6	13.5	21.2	30.6	41.9	55.	71.	89.	109.	131.	187.	257.	350.	470.	620.	830.
8	15.6	24.4	35.3	48.4	64.	82.	103.	126.	151.	216.	297.	404.	540.	720.	960.
10	17.4	27.3	39.5	54.	71.	92.	115.	140.	169.	241.	332.	452.	610.	810.	1070.
15	21.3	33.5	48.3	66.	88.	112.	141.	172.	207.	296.	407.	550.	740.	990.	1310.
20	24.6	38.6	56.	76.	101.	130.	162.	199.	239.	341.	470.	640.	860.	1140.	1520.
30	30.1	47.3	68.	94.	124.	159.	199.	243.	293.	418.	580.	780.	1050.	1440.	1860.
40	34.8	55.	79.	108.	143.	183.	230.	281.	338.	483.	660.	900.	1210.	1610.	2140.
50	38.9	61.	88.	121.	160.	205.	257.	314.	378.	540.	740.	1010.	1360.	1800.	2400.
60	42.6	67.	97.	132.	175.	225.	281.	344.	414.	590.	810.	1110.	1490.	1980.	2630.
80	49.2	77.	112.	153.	202.	259.	325.	397.	479.	680.	940.	1280.	1720.	2300.	3030.
100	55.	86.	125.	172.	226.	290.	362.	444.	540.	760.	1050.	1420.	1910.	2550.	3390.

ORIFICE CAPACITIES FOR GAS

Table 104
10 INCH LINE HOURLY CAPACITIES OF ORIFICES PRESSURE 0 LB.
 Specific Gravity .600 Pressure Connections at 2½ and 8 Diameters. Pressure Base 4 oz.
 Base and Flowing Temperature 60 deg. Fahr. Atmospheric Pressure 14.4 lb.
 All capacities expressed in thousands of cubic feet.

Differential in Inches of Water	Diameter of Orifice in Inches																
	1¼	1½	1¾	2	2¼	2½	2¾	3	3½	4	4½	5	5½	6	6½	7	7½
.10	.51	.73	1.01	1.32	1.68	2.09	2.56	3.05	4.2	5.7	7.5	9.7	12.3	15.6	19.7	24.8	30.7
.15	.62	.90	1.23	1.61	2.05	2.56	3.16	3.73	5.2	7.0	9.1	11.9	15.1	19.1	24.2	30.4	37.6
.20	.72	1.04	1.42	1.86	2.37	2.95	3.65	4.31	6.0	8.0	10.6	13.7	17.4	22.0	27.9	35.1	43.5
.30	.88	1.27	1.74	2.28	2.90	3.61	4.47	5.3	7.4	9.9	12.9	16.8	21.4	26.9	34.2	42.9	53.
.40	1.02	1.47	2.01	2.63	3.35	4.17	5.2	6.1	8.5	11.4	14.9	19.4	24.7	31.1	39.5	49.6	61.
.50	1.13	1.64	2.25	2.94	3.75	4.67	5.8	6.8	9.5	12.7	16.7	21.6	27.6	34.8	44.1	55.	69.
.60	1.24	1.80	2.46	3.22	4.11	5.1	6.3	7.5	10.4	13.7	18.3	23.7	30.2	38.1	48.3	61.	75.
.80	1.44	2.08	2.84	3.72	4.74	5.9	7.2	8.6	12.0	16.1	21.1	27.4	34.9	44.0	56.	70.	87.
1	1.60	2.31	3.17	4.16	5.3	6.6	8.0	9.7	13.4	18.0	23.6	30.5	38.8	49.	62.	78.	97.
1.5	1.97	2.84	3.89	5.1	6.5	8.1	9.9	11.8	16.5	22.0	28.9	37.5	47.8	60.	76.	96.	119.
2	2.27	3.28	4.50	5.9	7.5	9.3	11.4	13.6	19.0	25.5	33.4	43.3	55.	70.	88.	111.	137.
3	2.78	4.02	5.5	7.2	9.2	11.4	14.0	16.7	23.3	31.2	40.9	53.	68.	85.	108.	136.	168.
4	3.21	4.64	6.4	8.3	10.6	13.2	16.2	19.3	26.9	36.0	47.2	61.	78.	98.	125.	157.	194.
6	3.93	5.7	7.8	10.2	13.0	16.2	19.8	23.6	32.9	44.1	58.	75.	96.	121.	153.	192.	238.
8	4.54	6.6	9.0	11.8	15.0	18.7	22.9	27.2	38.0	51.	67.	87.	110.	139.	176.	222.	275.
10	5.1	7.3	10.1	13.2	16.8	20.9	25.6	30.5	42.5	57.	75.	97.	123.	156.	197.	248.	307.
15	6.2	9.0	12.3	16.1	20.5	25.6	31.6	37.3	52.	70.	91.	119.	151.	191.	242.	304.	376.
20	7.2	10.4	14.2	18.6	23.7	29.5	36.5	43.1	60.	80.	106.	137.	174.	220.	279.	351.	435.
30	8.8	12.7	17.4	22.8	29.0	36.1	44.7	53.	74.	99.	129.	168.	214.	269.	342.	429.	530.
40	10.2	14.7	20.1	26.3	33.5	41.7	52.	61.	85.	114.	149.	194.	247.	311.	395.	496.	610.
50	11.3	16.4	22.5	29.4	37.5	46.7	58.	68.	95.	127.	167.	216.	276.	348.	441.	550.	690.

ORIFICE CAPACITIES FOR GAS

Table 105
10 INCH LINE HOURLY CAPACITIES OF ORIFICES PRESSURE 10 LB.
 Specific Gravity .600 Pressure Connections at 2½ and 8 Diameters. Pressure Base 4 oz.
 Base and Flowing Temperature 60 deg. Fahr. Atmospheric Pressure 14.4 lb.
 All capacities expressed in thousands of cubic feet.

Differential in Inches of Water	Diameter of Orifice in Inches																
	1¼	1½	1¾	2	2¼	2½	2¾	3	3½	4	4½	5	5½	6	6½	7	7½
.10	.66	.96	1.30	1.71	2.18	2.71	3.29	4.0	5.5	7.4	9.8	12.5	16.0	20.3	25.6	31.9	40.
.15	.81	1.17	1.60	2.09	2.67	3.32	4.03	4.9	6.7	9.1	12.0	15.3	19.6	24.9	31.3	39.1	49.
.20	.93	1.36	1.84	2.41	3.09	3.83	4.65	5.6	7.8	10.5	13.8	17.7	22.6	28.7	36.1	45.2	57.
.30	1.14	1.66	2.26	2.96	3.78	4.69	5.7	6.9	9.5	12.8	16.9	21.7	27.7	35.2	44.3	55.	70.
.40	1.32	1.92	2.61	3.42	4.36	5.4	6.6	8.0	11.0	14.8	19.5	25.0	31.9	40.6	51.	64.	80.
.50	1.47	2.14	2.91	3.82	4.88	6.1	7.4	8.9	12.3	16.5	21.8	28.0	35.7	45.4	57.	71.	90.
.60	1.61	2.35	3.19	4.18	5.3	6.6	8.1	9.8	13.5	18.1	23.9	30.7	39.1	49.7	63.	78.	99.
.80	1.86	2.71	3.69	4.83	6.2	7.7	9.3	11.3	15.6	20.9	27.6	35.4	45.2	57.	72.	90.	114.
1	2.09	3.01	4.12	5.4	6.9	8.5	10.4	12.5	17.5	23.5	30.8	40.0	51.	64.	81.	101.	127.
1.5	2.55	3.71	5.0	6.6	8.5	10.5	12.7	15.4	21.3	28.7	37.8	49.	62.	79.	99.	124.	156.
2	2.94	4.29	5.8	7.6	9.8	12.1	14.7	17.8	24.6	33.1	43.7	56.	71.	91.	114.	143.	180.
3	3.60	5.2	7.1	9.4	12.0	14.8	18.0	21.8	30.1	40.5	54.	69.	87.	111.	140.	175.	220.
4	4.16	6.0	8.2	10.8	13.8	17.1	20.8	25.2	34.8	46.8	62.	79.	101.	128.	162.	202.	254.
6	5.1	7.4	10.1	13.2	16.9	21.0	25.5	30.9	42.6	57.	76.	97.	124.	157.	198.	247.	312.
8	5.9	8.6	11.7	15.3	19.5	24.2	29.4	35.6	49.2	66.	87.	112.	143.	182.	229.	286.	360.
10	6.6	9.6	13.0	17.1	21.8	27.1	32.9	39.8	55.	74.	98.	125.	160.	203.	256.	319.	402.
15	8.1	11.7	16.0	20.9	26.7	33.2	40.3	48.8	67.	91.	120.	153.	196.	249.	313.	391.	493.
20	9.3	13.6	18.4	24.1	30.9	38.3	46.5	56.	78.	106.	138.	177.	226.	287.	361.	452.	570.
30	11.4	16.6	22.6	29.6	37.8	46.9	57.	69	95.	128	169	217	277	352	443	550	700
40	13.2	19.2	26.1	34.2	43.6	54.	66.	80.	110.	148.	195.	250.	319.	406.	510.	640.	800.
50	14.7	21.4	29.1	38.2	48.8	61.	74.	89.	123.	165.	218.	280.	357.	454.	570.	710.	900.

ORIFICE CAPACITIES FOR GAS

Table 106
10 INCH LINE HOURLY CAPACITIES OF ORIFICES PRESSURE 20 LB.
 Specific Gravity .600 Pressure Connections at 2½ and 8 Diameters. Pressure Base 4 oz.
 Base and Flowing Temperature 60 deg. Fahr. Atmospheric Pressure 14.4 lb.
 All capacities expressed in thousands of cubic feet.

Differential in Inches of Water	Diameter of Orifice in Inches																
	1¼	1½	1¾	2	2¼	2½	2¾	3	3½	4	4½	5	5½	6	6½	7	7½
.40	1.57	2.26	3.09	4.06	5.2	6.5	7.9	9.4	13.2	17.6	23.1	29.9	37.9	48.	61.	76.	95.
.50	1.75	2.52	3.45	4.54	5.8	7.2	8.8	10.5	14.7	19.6	25.9	33.4	42.4	54.	68.	85.	106.
.60	1.92	2.77	3.78	4.97	6.3	7.9	9.7	11.5	16.1	21.5	28.4	36.6	46.5	59.	75.	93.	116.
.80	2.22	3.19	4.36	5.7	7.2	9.1	11.2	13.3	18.6	24.8	32.7	42.2	54.0	68.	86.	107.	134.
1	2.48	3.58	4.89	6.4	8.2	10.2	12.4	14.9	20.7	27.8	36.5	47.1	60.	76.	96.	120.	150.
1.5	3.04	4.37	6.0	7.9	10.0	12.5	15.3	18.2	25.5	34.0	44.8	58.	73.	93.	118.	147.	184.
2	3.51	5.1	6.9	9.1	11.5	14.4	17.6	21.0	29.4	39.2	52.	67.	85.	108.	136.	170.	212.
3	4.30	6.2	8.5	11.1	14.1	17.7	21.6	25.8	36.0	48.1	63.	82.	104.	132.	167.	208.	259.
4	4.96	7.1	9.8	12.8	16.3	20.4	25.0	29.8	41.6	55.	73.	94.	120.	153.	193.	240.	300.
6	6.1	8.7	12.0	15.7	20.0	25.0	30.6	36.4	51.	68.	90.	116.	147.	187.	236.	293.	367.
8	7.0	10.1	13.8	18.2	23.1	28.8	35.3	42.1	59.	78.	104.	134.	170.	216.	272.	339.	424.
10	7.8	11.3	15.4	20.3	25.8	32.5	39.5	47.1	66.	88.	116.	149.	190.	241.	305.	379.	474.
15	9.6	13.8	18.9	24.9	31.6	39.5	48.3	58.	81.	107.	142.	183.	232.	296.	373.	464.	580.
20	11.1	16.0	21.8	28.7	36.5	45.6	56.	67.	93.	124.	164.	211.	268.	341.	431.	540.	670.
30	13.6	19.6	26.7	35.2	44.7	56.	68.	82.	114.	152.	200.	259.	329.	418.	530.	660.	820.
40	15.7	22.6	30.9	40.6	52.	65.	79.	94.	132.	176.	231.	299.	379.	483.	610.	760.	950.
50	17.5	25.2	34.5	45.4	58.	72.	88.	105.	147.	196.	259.	334.	424.	540.	680.	850.	1060.
60	19.2	27.7	37.8	49.7	63.	79.	97.	1154	161.	215.	285.	366.	465.	590.	750.	930.	1160.
80	22.2	31.9	43.6	57.	72.	91.	112.	133.	186.	248.	327.	422.	540.	680.	860.	1070.	1340.
100	24.8	35.8	48.9	64.	82.	102.	124.	149.	207.	278.	365.	471.	600.	760.	960.	1200.	1500.

ORIFICE CAPACITIES FOR GAS

Table 107
10 INCH LINE HOURLY CAPACITIES OF ORIFICES
PRESSURE 40 LB.
 Specific Gravity .600 Pressure Connections at 2½ and 8 Diameters. Pressure Base 4 oz.
 Base and Flowing Temperature 60 deg. Fahr. Atmospheric Pressure 14.4 lb.
 All capacities expressed in thousands of cubic feet.

Differential in Inches of Water	Diameter of Orifice in Inches																
	1¼	1½	1¾	2	2¼	2½	2¾	3	3½	4	4½	5	5½	6	6½	7	7½
1	3.1	4.5	6.2	8.1	10.3	12.8	15.6	18.7	26.0	35.0	46.	59.	76.	96.	121.	152.	189.
1.5	3.8	5.5	7.6	9.9	12.6	15.7	19.1	23.0	31.8	43.0	56.	72.	93.	117.	147.	186.	231.
2	4.4	6.4	8.7	11.4	14.6	18.2	22.1	26.5	36.8	49.6	65.	83.	107.	135.	170.	214.	267.
3	5.4	7.8	10.7	14.0	17.8	22.2	27.0	32.5	45.0	61.	80.	102.	131.	165.	208.	262.	327.
4	6.2	9.0	12.4	16.2	20.6	25.7	31.2	37.5	51.	70.	92.	118.	151.	191.	240.	303.	378.
6	7.6	11.1	15.1	19.8	25.2	31.4	38.2	45.9	64.	86.	113.	145.	185.	234.	293.	371.	463.
8	8.8	12.8	17.5	22.9	29.1	36.3	44.1	53.	74.	99.	130.	167.	214.	270.	339.	429.	530.
10	9.9	14.3	19.5	25.6	32.6	40.6	49.3	59.	82.	111.	145.	187.	239.	302.	379.	479.	600.
15	12.1	17.5	23.9	31.3	39.9	49.7	60.	73.	101.	136.	178.	229.	293.	369.	464.	590.	730.
20	14.0	20.2	27.6	36.1	46.1	57.	70.	84.	116.	157.	206.	264.	338.	427.	540.	680.	850.
30	17.1	24.8	33.8	44.3	56.	70.	85.	103.	142.	192.	252.	323.	414.	520.	660.	830.	1040.
40	19.7	28.6	39.1	51.	65.	81.	99.	119.	164.	222.	291.	373.	478.	600.	760.	960.	1200.
50	22.9	32.0	43.7	57.	73.	91.	110.	133.	184.	248.	325.	417.	530.	670.	850.	1070.	1340.
60	24.2	35.0	47.9	63.	80.	99.	121.	145.	201.	272.	356.	457.	590.	740.	930.	1170.	1460.
80	27.9	40.4	55.	72.	92.	115.	140.	168.	233.	314.	411.	530.	680.	850.	1070.	1360.	1690.
100	31.1	45.0	62.	81.	103.	128.	156.	187.	260.	350.	460.	590.	760.	960.	1210.	1520.	1890.

ORIFICE CAPACITIES FOR GAS

Table 108
10 INCH LINE HOURLY CAPACITIES OF ORIFICES PRESSURE 60 LB.
 Specific Gravity .600 Pressure Connections at 2½ and 8 Diameters. Pressure Base 4 oz.
 Base and Flowing Temperature 60 deg. Fahr. Atmospheric Pressure 14.4 lb.
 All capacities expressed in thousands of cubic feet.

Differential in inches of Water	Diameter of Orifice in Inches																
	1¼	1½	1¾	2	2¼	2½	2¾	3	3½	4	4½	5	5½	6	6½	7	7½
1	3.6	5.3	7.2	9.4	12.0	15.0	18.3	21.9	30.	41.	54.	69.	88.	112	141.	177.	221.
1.5	4.5	6.4	8.8	11.6	14.7	18.4	22.4	26.9	38.	50.	66.	85.	108.	137.	173.	217.	272.
2	5.2	7.4	10.2	13.4	17.0	21.2	25.9	31.1	43.	58.	76.	98.	124.	158.	200.	250.	314.
3	6.3	9.1	12.5	16.4	20.8	25.9	31.7	38.1	53.	71.	93.	120.	152.	194.	245.	307.	385.
4	7.3	10.5	14.4	18.9	24.0	30.0	36.6	44.0	61.	82.	107.	138.	176.	224.	283.	354.	444.
6	9.0	12.9	17.7	23.1	29.3	36.7	44.8	54.	75.	100.	131.	169.	216.	274.	347.	434.	540.
8	10.4	14.8	20.4	26.7	33.9	42.4	52.	62.	87.	115.	151.	195.	249.	317.	400.	500.	630.
10	11.6	16.6	22.8	29.9	37.9	47.4	58.	70.	97.	129.	169.	218.	278.	354.	448.	560.	700.
15	14.2	20.3	27.9	36.6	46.4	58.	71.	85.	119.	158.	207.	267.	341.	439.	550.	690.	860.
20	16.4	23.5	32.2	42.3	54.	67.	82.	98.	137.	182.	239.	309.	395.	500.	630.	790.	990.
30	20.0	28.8	39.5	52.	66.	82.	100.	120.	168.	223.	293.	378.	482.	610.	780.	970.	1220.
40	23.1	33.2	45.6	60.	76.	95.	116.	139.	194.	258.	338.	436.	560.	710.	900.	1120.	1400.
50	25.9	37.1	51.	67.	85.	106.	129.	156.	216.	288.	378.	488.	620.	790.	1000.	1250.	1570.
60	28.4	40.7	56.	73.	93.	116.	142.	170.	237.	316.	414.	530.	680.	870.	1100.	1370.	1720.
80	32.7	47.0	64.	85.	107.	134.	164.	197.	274.	365.	479.	620.	790.	1000.	1270.	1580.	1990.
100	36.4	53.0	72.	94.	120.	150.	183.	219.	305.	409.	540.	690.	880.	1120.	1410.	1770.	2210.

ORIFICE CAPACITIES FOR GAS

Table 109
10 INCH LINE HOURLY CAPACITIES OF ORIFICES PRESSURE 100 LB.
 Specific Gravity .600 Pressure Connections at 2½ and 8 Diameters. Pressure Base 4 oz.
 Base and Flowing Temperature 60 deg. Fahr. Atmospheric Pressure 14.4 lb.

All capacities expressed in thousands of cubic feet.

Differential in Inches of Water	Diameter of Orifice in Inches																
	1¼	1½	1¾	2	2¼	2½	2¾	3	3½	4	4½	5	5½	6	6½	7	7½
1	4.5	6.5	8.9	11.7	14.9	18.6	22.7	27.2	38.	51.	67.	86.	110.	139.	175.	220.	275.
1.5	5.5	8.0	11.0	14.3	18.3	22.8	27.7	33.4	46.	62.	82.	106.	135.	171.	215.	269.	337.
2	6.4	9.2	12.7	16.5	21.2	26.3	32.0	38.4	54.	71.	94.	122.	156.	197.	248.	311.	389.
3	7.8	11.3	15.5	20.3	25.9	32.2	39.1	47.2	65.	87.	115.	150.	191.	241.	304.	381.	476.
4	9.0	13.1	18.0	23.4	30.0	37.2	45.2	54.	76.	101.	133.	173.	220.	278.	351.	440.	550.
6	11.1	16.0	22.0	28.7	36.7	45.6	55.	67.	93.	124.	163.	212.	269.	341.	430.	540.	670.
8	12.8	18.5	25.4	33.1	42.4	53.	64.	77.	107.	143.	188.	244.	311.	394.	496.	620.	780.
10	14.3	20.7	28.4	37.0	47.4	59.	71.	86.	120.	160.	211.	273.	348.	440.	550.	700.	870.
15	17.5	25.3	34.8	45.3	58.	72.	88.	106.	146.	196.	259.	335.	426.	540.	680.	850.	1070.
20	20.2	29.2	40.2	52.	67.	83.	101.	122.	169.	226.	298.	386.	492.	620.	780.	980.	1230.
30	24.8	35.8	49.2	64.	82.	102.	124.	149.	207.	277.	365.	473.	600.	760.	960.	1200.	1510.
40	28.6	41.4	57.	74.	94.	118.	143.	172.	239.	319.	421.	550.	700.	880.	1110.	1390.	1740.
50	32.0	46.2	64.	83.	106.	132.	160.	193.	267.	357.	471.	610.	780.	980.	1240.	1560.	1940.
60	35.0	51.	70.	91.	116.	144.	175.	211.	293.	391.	520.	670.	850.	1080.	1360.	1700.	2130.
80	40.4	58.	80.	105.	134.	166.	202.	244.	338.	452.	600.	770.	980.	1250.	1570.	1970.	2460.
100	45.	65.	89.	117.	149.	186.	227.	272.	390.	508.	670.	860.	1100.	1390.	1750.	2200.	2750.

ORIFICE CAPACITIES FOR GAS

Table 110
10 INCH LINE HOURLY CAPACITIES OF ORIFICES PRESSURE 150 LB.
 Specific Gravity .600 Pressure Connections at 2½ and 8 Diameters. Pressure Base 4 oz.
 Base and Flowing Temperature 60 deg. Fahr. Atmospheric Pressure 14.4 lb.

All capacities expressed in thousands of cubic feet.

Differential in Inches of Water	Diameter of Orifice in Inches																
	1¼	1½	1¾	2	2¼	2½	2¾	3	3½	4	4½	5	5½	6	6½	7	7½
1	5.4	7.8	10.7	14.0	17.9	22.2	27.1	33.	45.	61.	80.	103.	131.	166.	210.	263.	329.
1.5	6.6	9.6	13.1	17.2	21.9	27.2	33.4	40.	55.	75.	97.	126.	160.	204.	257.	325.	404.
2	7.6	11.1	15.1	19.9	25.2	31.4	38.5	46.	64.	87.	113.	146.	185.	235.	297.	375.	467.
3	9.4	13.6	18.5	24.3	30.9	38.5	47.2	57.	78.	106.	138.	178.	227.	288.	364.	459.	570.
4	10.8	15.7	21.4	28.1	35.7	44.4	54.	65.	90.	122.	160.	206.	262.	333.	420.	520.	660.
6	13.2	19.2	26.2	34.4	43.7	54.	67.	80.	111.	150.	196.	252.	320.	408.	510.	650.	810.
8	15.3	22.2	30.2	39.7	50.	63.	77.	92.	128.	173.	226.	291.	370.	471.	590.	750.	930.
10	17.1	24.8	33.8	44.4	56.	70.	86.	103.	143.	194.	252.	326.	414.	530.	660.	840.	1040.
15	20.9	30.4	46.4	54.	69.	86.	106.	127.	175.	237.	309.	399.	510.	640.	810.	1030.	1280.
20	24.1	35.1	47.9	63.	80.	99.	122.	146.	202.	274.	358.	461.	580.	740.	940.	1190.	1480.
30	29.6	42.9	59.	77.	98.	122.	149.	179.	248.	335.	438.	560.	720.	910.	1150.	1450.	1810.
40	34.2	49.6	68.	89.	113.	140.	172.	207.	288.	387.	510.	650.	830.	1050.	1330.	1680.	2090.
50	38.2	55.	76.	99.	126.	157.	193.	231.	320.	433.	570.	730.	920.	1180.	1480.	1870.	2330.
60	41.8	61.	83.	109.	138.	172.	211.	253.	350.	474.	620.	800.	1010.	1290.	1680.	2050.	2560.
80	48.3	70.	96.	126.	160.	199.	244.	292.	404.	550.	720.	920.	1170.	1490.	1930.	2370.	2950.
100	54.	78.	107.	140.	179.	222.	271.	326.	453.	610.	800.	1030.	1310.	1660.	2100.	2630.	3290.

ORIFICE CAPACITIES FOR GAS

Table 111
10 INCH LINE HOURLY CAPACITIES OF ORIFICES **PRESSURE 200 LB.**
 Specific Gravity .600 Pressure Connections at 2½ and 8 Diameters. Pressure Base 4 oz.
 Base and Flowing Temperature 60 deg. Fahr. Atmospheric Pressure 14.4 lb.
 All capacities expressed in thousands of cubic feet.

Differential in Inches of Water	Diameter of Orifice in Inches																
	1¼	1½	1¾	2	2¼	2½	2¾	3	3½	4	4½	5	5½	6	6½	7	7½
1	6.2	8.9	12.2	16.0	20.4	25.4	31.	37.	52.	70.	91.	117.	149.	190.	240.	300.	376.
1.5	7.6	11.0	15.0	19.7	25.0	31.2	38.	46.	64.	85.	111.	143.	183.	233.	294.	367.	459.
2	8.7	12.7	17.3	22.7	28.8	36.1	44.	53.	74.	98.	129.	165.	212.	269.	339.	424.	530.
3	10.7	15.5	21.2	27.8	35.3	44.2	54.	64.	90.	121.	157.	203.	260.	330.	416.	520.	650.
4	12.4	17.9	24.5	32.1	40.8	50.	62.	74.	104.	139.	182.	234.	300.	381.	480.	600.	750.
6	15.1	21.9	30.0	39.3	50.	62.	76.	91.	127.	171.	223.	287.	367.	467.	590.	730.	920.
8	17.5	25.3	34.6	45.4	58.	72.	87.	105.	147.	197.	257.	331.	424.	540.	680.	850.	1060.
10	19.5	28.3	38.7	51.	65.	81.	98.	118.	164.	220.	287.	370.	474.	600.	760.	950.	1190.
15	23.9	34.7	47.4	62.	79.	99.	120.	144.	200.	270.	352.	453.	580.	740.	930.	1160.	1450.
20	27.6	40.1	55.	72.	91.	114.	138.	166.	231.	311.	407.	520.	670.	850.	1070.	1340.	1680.
30	33.8	49.1	67.	88.	112.	140.	169.	204.	285.	381.	498.	640.	820.	1040.	1310.	1640.	2050.
40	39.1	57.	77.	102.	129.	161.	195.	235.	329.	440.	570.	740.	950.	1200.	1520.	1900.	2370.
50	43.7	63.	87.	113.	144.	180.	218.	263.	368.	492.	640.	830.	1060.	1350.	1700.	2120.	2650.
60	47.9	69.	95.	124.	158.	198.	239.	288.	403.	540.	700.	910.	1160.	1480.	1860.	2320.	2900.
80	55.	80.	109.	144.	182.	228.	276.	333.	465.	620.	810.	1050.	1340.	1700.	2150.	2680.	3350.
100	62.	89.	122.	160.	204.	254.	310.	372.	520.	700.	910.	1170.	1490.	1900.	2400.	3000.	3760.

Table 112
10 INCH LINE HOURLY CAPACITIES OF ORIFICES PRESSURE 300 LB.
 Specific Gravity .600 Pressure Connections at 2½ and 8 Diameters. Pressure Base 4 oz.
 Base and Flowing Temperature 60 deg. Fahr. Atmospheric Pressure 14.4 lb.

All capacities expressed in thousands of cubic feet.

Differential in Inches of Water	Diameter of Orifice in Inches																
	1¼	1½	1¾	2	2¼	2½	2¾	3	3½	4	4½	5	5½	6	6½	7	7½
1	7.5	10.8	14.8	19.4	24.8	31.	38.	45.	63.	84.	110.	142.	181.	230.	290.	364.	455.
1.5	9.2	13.2	18.1	23.9	30.4	38.	46.	55.	77.	103.	135.	175.	222.	282.	355.	448.	560.
2	10.6	15.3	20.9	27.6	35.1	44.	53.	64.	89.	119.	156.	202.	257.	325.	410.	520.	640.
3	13.0	18.7	25.6	33.8	43.0	54.	65.	78.	109.	146.	191.	247.	314.	398.	500.	630.	790.
4	15.0	21.6	29.5	39.0	49.6	62.	75.	90.	126.	168.	220.	286.	363.	460.	580.	730.	910.
6	18.3	26.5	36.1	47.8	61.	76.	92.	111.	154.	206.	269.	350.	445.	560.	710.	900.	1120.
8	21.2	30.5	41.7	55.	70.	87.	106.	128.	178.	238.	311.	404.	510.	650.	820.	1040.	1290.
10	23.7	34.2	46.7	62.	78.	98.	119.	143.	199.	266.	348.	452.	570.	730.	920.	1160.	1440.
15	29.0	41.8	57.	76.	96.	120.	145.	175.	244.	325.	426.	550.	700.	890.	1120.	1420.	1770.
20	33.5	48.3	66.	87.	111.	138.	168.	202.	282.	376.	492.	640.	810.	1030.	1300.	1640.	2040.
30	41.0	59.	81.	107.	136.	169.	205.	248.	345.	460.	600.	780.	990.	1260.	1590.	2000.	2500.
40	47.4	68.	93.	123.	157.	195.	237.	286.	398.	530.	700.	900.	1150.	1450.	1830.	2310.	2880.
50	53.	76.	104.	138.	175.	218.	265.	320.	446.	590.	780.	1010.	1280.	1630.	2050.	2590.	3220.
60	58.	84.	114.	151.	192.	239.	290.	350.	488.	650.	850.	1110.	1410.	1780.	2250.	2840.	3530.
80	67.	97.	132.	174.	222.	276.	335.	404.	560.	750.	980.	1280.	1620.	2060.	2590.	3270.	4080.
100	75.	108.	148.	194.	248.	308.	375.	451.	630.	840.	1100.	1420.	1810.	2300.	2900.	3640.	4550.

Table 113
10 INCH LINE HOURLY CAPACITIES OF ORIFICES PRESSURE 400 LB.
 Specific Gravity .600 Pressure Connections at 2½ and 8 Diameters. Pressure Base 4 oz.
 Base and Flowing Temperature 60 deg. Fahr. Atmospheric Pressure 14.4 lb.
 All capacities expressed in thousands of cubic feet.

Differential in Inches of Water	Diameter of Orifice in Inches																
	1¼	1½	1¾	2	2¼	2½	2¾	3	3½	4	4½	5	5½	6	6½	7	7½
1	8.6	12.4	17.0	22.3	28.4	35.	43.	52.	72.	97.	127.	163.	208.	264.	333.	418.	520.
1.5	10.6	15.3	20.8	27.4	34.9	43.	53.	64.	88.	118.	156.	200.	255.	325.	408.	510.	640.
2	12.2	17.6	24.0	31.7	40.3	50.	61.	74.	102.	136.	180.	231.	294.	375.	471.	590.	740.
3	15.0	21.6	29.4	38.8	49.4	61.	75.	90.	126.	167.	220.	283.	360.	459.	580.	730.	910.
4	17.3	25.0	33.9	44.8	57.	71.	86.	104.	144.	193.	254.	327.	416.	520.	670.	840.	1050.
6	21.2	30.6	41.5	55.	70.	87.	106.	127.	177.	236.	312.	400.	510.	650.	820.	1030.	1290.
8	24.4	35.3	47.9	63.	81.	100.	122.	147.	204.	272.	360.	462.	590.	750.	940.	1190.	1480.
10	27.3	39.5	54.	71.	90.	112.	137.	164.	228.	305.	402.	520.	660.	840.	1050.	1330.	1660.
15	33.5	48.3	66.	87.	110.	137.	167.	201.	279.	373.	493.	630.	810.	1030.	1290.	1630.	2030.
20	38.6	56.	76.	100.	127.	158.	193.	233.	322.	431.	570.	730.	930.	1190.	1490.	1880.	2350.
30	47.3	68.	93.	123.	156.	194.	237.	285.	395.	530.	700.	900.	1140.	1450.	1820.	2300.	2880.
40	55.	79.	107.	142.	180.	224.	273.	329.	456.	610.	800.	1030.	1320.	1680.	2110.	2660.	3320.
50	61.	88.	120.	158.	202.	250.	305.	368.	510.	680.	900.	1160.	1470.	1870.	2350.	2970.	3710.
60	67.	97.	131.	174.	221.	274.	335.	403.	560.	750.	990.	1270.	1610.	2050.	2590.	3250.	4070.
80	77.	112.	152.	200.	255.	317.	386.	465.	640.	860.	1140.	1460.	1860.	2370.	2980.	3760.	4700.
100	86.	124.	170.	223.	284.	354.	431.	520.	720.	970.	1270.	1630.	2080.	2640.	3330.	4180.	5200.

Table 114
4 INCH LINE HOURLY CAPACITIES OF ORIFICES PRESSURE 0 LB.
 Specific Gravity .600 Pressure Connections at Flange. Pressure Base 4 oz.
 Base and Flowing Temperature 60 deg. Fahr. Atmospheric Pressure 14.4 lb.
 All capacities expressed in thousands of cubic feet.

Differential in Inches of Water	Diameter of Orifice in Inches												
	1/2	5/8	3/4	7/8	1	1 1/4	1 1/2	1 3/4	2	2 1/4	2 1/2	2 3/4	3
.10	.080	.124	.180	.243	.319	.50	.71	.98	1.29	1.69	2.18	2.78	3.5
.15	.098	.152	.221	.298	.391	.61	.88	1.20	1.58	2.07	2.67	3.41	4.3
.20	.113	.176	.255	.344	.452	.70	1.01	1.38	1.82	2.39	3.09	3.94	5.0
.30	.138	.215	.312	.422	.55	.86	1.24	1.69	2.23	2.98	3.78	4.84	6.1
.40	.160	.249	.361	.487	.64	1.00	1.43	1.95	2.58	3.38	4.36	5.6	7.1
.50	.179	.278	.403	.54	.71	1.11	1.60	2.18	2.88	3.78	4.88	6.2	7.9
.60	.196	.304	.442	.60	.78	1.22	1.75	2.39	3.16	4.14	5.3	6.8	8.7
.80	.226	.352	.51	.69	.90	1.41	2.02	2.76	3.65	4.79	6.2	7.9	10.0
1	.252	.394	.57	.77	1.00	1.58	2.26	3.09	4.09	5.3	6.9	8.8	11.1
1.5	.309	.481	.70	.94	1.24	1.93	2.77	3.78	5.0	6.6	8.5	10.8	13.7
2	.357	.55	.81	1.09	1.43	2.23	3.20	4.37	5.8	7.6	9.8	12.4	15.8
3	.437	.68	.99	1.33	1.75	2.73	3.91	5.4	7.1	9.3	12.0	15.2	19.4
4	.50	.79	1.14	1.54	2.02	3.15	4.52	6.2	8.2	10.7	13.8	17.6	22.4
6	.62	.96	1.40	1.89	2.47	3.86	5.5	7.6	10.0	13.1	16.9	21.6	27.4
8	.71	1.11	1.61	2.18	2.86	4.46	6.4	8.7	11.5	15.1	19.5	24.9	31.7
10	.80	1.24	1.80	2.43	3.19	4.98	7.1	9.8	12.9	16.9	21.8	27.8	35.4
15	.98	1.52	2.21	2.98	3.91	6.1	8.8	12.0	15.8	20.7	26.7	34.1	43.4
20	1.13	1.76	2.55	3.44	4.52	7.0	10.1	13.8	18.2	23.9	30.9	39.4	50.
30	1.38	2.15	3.12	4.22	5.5	8.6	12.4	16.9	22.3	29.3	37.8	48.2	61.
40	1.60	2.49	3.61	4.87	6.4	10.0	14.3	19.5	25.8	33.8	43.6	56.	71.
50	1.79	2.78	4.03	5.4	7.1	11.1	16.0	21.8	28.8	37.8	48.8	62.	79.

ORIFICE CAPACITIES FOR GAS

Table 115
4 INCH LINE HOURLY CAPACITIES OF ORIFICES PRESSURE 10 LB.
 Specific Gravity .600 Pressure Connections at Flange. Pressure Base 4 oz.
 Base and Flowing Temperature 60 deg. Fahr. Atmospheric Pressure 14.4 lb.
 All capacities expressed in thousands of cubic feet.

Differential in Inches of Water	Diameter of Orifice in Inches												
	1/2	5/8	3/4	7/8	1	1 1/4	1 1/2	1 3/4	2	2 1/4	2 1/2	2 3/4	3
.10	.103	.163	.235	.319	.41	.65	.93	1.28	1.69	2.20	2.83	3.6	4.6
.15	.127	.199	.287	.391	.51	.80	1.14	1.56	2.07	2.70	3.47	4.4	5.6
.20	.146	.230	.332	.452	.58	.92	1.32	1.81	2.39	3.11	4.01	5.1	6.5
.30	.179	.282	.406	.55	.72	1.13	1.62	2.21	2.93	3.81	4.91	6.2	8.0
.40	.207	.326	.469	.64	.83	1.30	1.87	2.56	3.38	4.40	5.7	7.2	9.2
.50	.231	.364	.52	.71	.92	1.46	2.09	2.86	3.78	4.92	6.3	8.1	10.3
.60	.253	.399	.57	.78	1.01	1.60	2.29	3.12	4.14	5.4	6.9	8.8	11.2
.80	.292	.461	.66	.90	1.17	1.84	2.64	3.61	4.79	6.2	8.0	10.2	13.0
1	.329	.51	.74	1.00	1.31	2.05	2.95	4.0	5.3	6.9	9.0	11.4	14.5
1.5	.400	.63	.91	1.24	1.60	2.52	3.61	5.0	6.6	8.5	11.0	14.0	17.7
2	.46	.73	1.05	1.43	1.85	2.91	4.17	5.7	7.6	9.8	12.7	16.1	20.5
3	.57	.89	1.29	1.75	2.27	3.57	5.1	7.0	9.3	12.1	15.5	19.7	25.2
4	.65	1.03	1.48	2.02	2.62	4.12	5.9	8.1	10.7	13.9	17.9	22.8	29.0
6	.80	1.26	1.82	2.47	3.20	5.0	7.2	9.9	13.1	17.1	21.9	27.9	35.6
8	.92	1.46	2.10	2.86	3.70	5.8	8.3	11.4	15.1	19.7	25.3	32.2	41.0
10	1.03	1.63	2.35	3.19	4.14	6.5	9.3	12.8	16.9	22.0	28.3	36.1	45.9
15	1.27	1.99	2.87	3.91	5.1	8.0	11.4	15.6	20.7	27.0	34.7	44.2	56.
20	1.46	2.30	3.32	4.52	5.8	9.2	13.2	18.1	23.9	31.1	40.1	51.	65.
30	1.79	2.82	4.06	5.5	7.2	11.3	16.2	22.1	29.3	38.1	49.1	62.	80.
40	2.07	3.26	4.69	6.4	8.3	13.0	18.7	25.6	33.8	44.0	57.	72.	92.
50	2.31	3.64	5.2	7.1	9.2	14.6	20.9	28.6	37.8	49.2	63.	81.	103.

ORIFICE CAPACITIES FOR GAS

Table 116
4 INCH LINE HOURLY CAPACITIES OF ORIFICES PRESSURE 20 LB.
 Specific Gravity .600 Pressure Connections at Flanges. Pressure Base 4 oz.
 Base and Flowing Temperature 60 deg. Fahr. Atmospheric Pressure 14.4 lb.
 All capacities expressed in thousands of cubic feet.

Differential in Inches of Water	Diameter of Orifice in Inches												
	1/2	5/8	3/4	7/8	1	1 1/4	1 1/2	1 3/4	2	2 1/4	2 1/2	2 3/4	3
.40	.247	.387	.55	.75	.99	1.54	2.22	3.04	4.02	5.2	6.7	8.6	10.9
.50	.276	.433	.62	.84	1.10	1.73	2.48	3.39	4.50	5.8	7.5	9.6	12.2
.60	.302	.474	.68	.92	1.21	1.89	2.72	3.72	4.93	6.4	8.2	10.5	13.4
.80	.349	.55	.78	1.06	1.40	2.18	3.14	4.29	5.7	7.4	9.5	12.1	17.2
1	.390	.61	.87	1.19	1.56	2.44	3.51	4.78	6.3	8.3	10.6	13.6	17.3
1.5	.478	.75	1.07	1.46	1.91	2.99	4.30	5.9	7.8	10.1	13.0	16.6	21.1
2	.55	.87	1.23	1.68	2.21	3.45	4.96	6.8	9.0	11.7	15.0	19.2	24.4
3	.68	1.06	1.51	2.06	2.70	4.23	6.1	8.3	11.0	14.3	18.4	23.5	29.9
4	.78	1.22	1.74	2.38	3.12	4.88	7.0	9.6	12.7	16.5	21.2	27.1	34.5
6	.96	1.50	2.14	2.91	3.82	6.0	8.6	11.8	15.6	20.2	26.0	33.2	42.3
8	1.10	1.73	2.47	3.37	4.41	6.9	9.9	13.6	18.0	23.3	30.0	38.4	48.8
10	1.23	1.94	2.76	3.76	4.93	7.7	11.1	15.2	20.1	26.1	33.5	42.9	55.
15	1.51	2.37	3.38	4.61	6.0	9.5	13.6	18.6	24.6	31.9	41.1	53.	67.
20	1.71	2.74	3.90	5.3	7.0	10.9	15.7	21.5	28.4	36.9	47.4	61.	77.
30	2.14	3.35	4.78	6.5	8.5	13.4	19.2	26.3	34.8	45.1	58.	74.	94.
40	2.47	3.87	5.5	7.5	9.9	15.4	22.2	30.4	40.2	52.	67.	86.	109.
50	2.76	4.33	6.2	8.4	11.0	17.3	24.8	33.9	45.0	58.	75.	96.	122.
60	3.02	4.74	6.8	9.2	12.1	18.9	27.2	37.2	49.3	64.	82.	105.	134.
80	3.49	5.5	7.8	10.6	14.0	21.8	31.4	42.9	57.	74.	95.	121.	154.
100	3.90	6.1	8.7	11.9	15.6	24.4	35.1	47.8	63.	83.	106.	136.	173.

Table 117
4 INCH LINE HOURLY CAPACITIES OF ORIFICES PRESSURE 40 LB.
 Specific Gravity .60 Pressure Connections at Flange. Pressure Base 4 oz.
 Base and Flowing Temperature 60 deg. Fahr. Atmospheric Pressure 14.4 lb.
 All capacities expressed in thousands of cubic feet.

Differential in Inches of Water	Diameter of Orifice in Inches												
	1/2	5/8	3/4	7/8	1	1 1/4	1 1/2	1 3/4	2	2 1/4	2 1/2	2 3/4	3
1	.49	.77	1.10	1.50	1.96	3.06	4.4	6.0	8.0	10.3	13.3	17.1	21.7
1.5	.60	.93	1.35	1.84	2.41	3.75	5.4	7.3	9.8	12.7	16.5	20.9	26.7
2	.70	1.08	1.56	2.12	2.78	4.33	6.2	8.5	11.3	14.7	19.0	24.2	30.8
3	.85	1.32	1.91	2.60	3.40	5.3	7.6	10.4	13.8	18.0	23.3	29.6	37.8
4	.98	1.53	2.20	3.00	3.93	6.1	8.8	12.0	16.0	20.8	26.9	34.2	43.6
6	1.21	1.87	2.69	3.67	4.81	7.5	10.8	14.7	19.6	25.5	32.9	41.9	53.
8	1.39	2.16	3.11	4.24	5.6	8.7	12.4	17.0	22.6	29.4	38.0	48.4	62.
10	1.56	2.41	3.48	4.74	6.2	9.7	13.9	19.0	25.3	32.9	42.5	54.	69.
15	1.91	2.96	4.26	5.8	7.6	11.9	17.0	23.2	31.0	40.3	52.	66.	84.
20	2.20	3.41	4.92	6.7	8.8	13.7	19.7	26.8	35.8	46.5	60.	76.	97.
30	2.69	4.18	6.0	8.2	10.8	16.8	24.1	32.9	43.8	57.	74.	94.	119.
40	3.11	4.83	7.0	9.5	12.4	19.4	27.8	37.9	51.	66.	85.	108.	138.
50	3.48	5.4	7.8	10.6	13.9	21.6	31.1	42.4	57.	74.	95.	121.	154.
60	3.81	5.9	8.5	11.6	15.2	23.7	34.1	46.5	62.	81.	104.	132.	169.
80	4.40	6.8	9.8	13.4	17.6	27.4	39.4	54.	72.	93.	120.	153.	195.
100	4.90	7.7	11.0	15.0	19.6	30.6	44.	60.	80.	103.	133.	171.	217.

Table 118
4 INCH LINE HOURLY CAPACITIES OF ORIFICES PRESSURE 60 LB.
 Specific Gravity .600 Pressure Connections at Flange. Pressure Base 4 oz.
 Base and Flowing Temperature 60 deg. Fahr. Atmospheric Pressure 14.4 lb.
 All capacities expressed in thousands of cubic feet.

Differential in Inches of Water	Diameter of Orifice in Inches												
	1/2	5/8	3/4	7/8	1	1 1/4	1 1/2	1 3/4	2	2 1/4	2 1/2	2 3/4	3
1	.57	.89	1.29	1.75	2.29	3.6	5.2	7.0	9.3	12.1	15.6	20.0	25.4
1.5	.70	1.10	1.59	2.15	2.82	4.4	6.3	8.5	11.5	14.8	19.1	24.4	31.2
2	.81	1.27	1.83	2.48	3.25	5.1	7.3	9.8	13.2	17.1	22.1	28.2	36.1
3	1.00	1.55	2.25	3.04	3.98	6.2	8.9	12.1	16.2	21.0	27.0	34.6	44.2
4	1.15	1.79	2.59	3.51	4.60	7.1	10.3	14.0	18.7	24.2	31.2	40.0	50.
6	1.41	2.19	3.17	4.30	5.6	8.7	12.6	17.1	22.9	29.7	38.2	48.9	62.
8	1.63	2.53	3.67	4.96	6.5	10.1	14.6	19.7	26.5	34.3	44.1	56.	72.
10	1.82	2.83	4.10	5.5	7.3	11.3	16.3	22.1	29.6	38.3	49.3	63.	81.
15	2.23	3.47	5.0	6.8	8.9	13.8	19.9	27.1	36.3	46.9	60.	77.	99.
20	2.57	4.01	5.8	7.8	10.3	16.0	23.0	31.3	41.9	54.	70.	89.	114.
30	3.15	4.91	7.1	9.6	12.6	19.6	28.2	38.3	51.	66.	85.	109.	140.
40	3.64	5.7	8.2	11.1	14.5	22.6	32.6	44.2	59.	77.	99.	126.	161.
50	4.07	6.3	9.2	12.4	16.3	25.2	36.4	49.4	66.	86.	110.	141.	180.
60	4.45	6.9	10.0	13.6	17.8	27.7	39.9	54.	73.	94.	121.	154.	198.
80	5.1	8.0	11.6	15.7	20.6	31.9	46.1	62.	84.	108.	140.	178.	228.
100	5.7	8.9	12.9	17.5	22.9	35.8	52.	70.	93.	121.	156.	200.	254.

Table 119
4 INCH LINE HOURLY CAPACITIES OF ORIFICES · PRESSURE 100 LB.
 Specific Gravity .600 Pressure Connections at Flange. Pressure Base 4 oz.
 Base and Flowing Temperature 60 deg. Fahr. Atmospheric Pressure 14.4 lb.
 All capacities expressed in thousands of cubic feet.

Differential in Inches of Water	Diameter of Orifice in Inches												
	½	⅕	¾	⅞	1	1¼	1½	1¾	2	2¼	2½	2¾	3
1	.71	1.11	1.60	2.17	2.84	4.4	6.4	8.7	11.5	15.0	19.4	24.8	31.5
1.5	.87	1.36	1.97	2.67	3.49	5.4	7.9	10.7	14.2	18.3	23.7	30.4	38.6
2	1.01	1.57	2.27	3.08	4.03	6.3	9.1	12.3	16.4	21.2	27.4	35.1	44.6
3	1.24	1.92	2.78	3.78	4.94	7.7	11.1	15.1	20.1	25.9	33.5	43.0	55.
4	1.43	2.22	3.21	4.36	5.7	8.9	12.8	17.4	23.2	30.0	38.7	49.6	63.
6	1.75	2.72	3.93	5.3	7.0	10.9	15.7	21.4	28.4	36.7	47.4	61.	77.
8	2.02	3.14	4.54	6.2	8.1	12.6	18.2	24.7	32.8	42.4	55.	70.	89.
10	2.26	3.51	5.1	6.9	9.0	14.0	20.3	27.6	36.7	47.4	61.	78.	100.
15	2.77	4.30	6.2	8.4	11.0	17.2	24.9	33.8	44.4	58.	75.	96.	122.
20	3.19	4.96	7.2	9.7	12.7	19.9	28.7	39.0	52.	67.	87.	111.	141.
30	3.91	6.1	8.8	11.9	15.6	24.3	35.2	47.8	64.	82.	106.	136.	173.
40	4.52	7.0	10.2	13.8	18.0	28.1	40.6	55.	73.	94.	122.	157.	199.
50	5.0	7.8	11.3	15.4	20.2	31.4	45.4	62.	82.	106.	137.	175.	223.
60	5.5	8.6	12.4	16.9	22.1	34.4	49.7	68.	90.	116.	150.	192.	244.
80	6.4	9.9	14.4	19.5	25.5	39.7	57.	78.	104.	134.	173.	222.	282.
100	7.1	11.1	16.0	21.7	28.4	44.4	64.	87.	115.	150.	194.	248.	315.

Table 120
4 INCH LINE HOURLY CAPACITIES OF ORIFICES PRESSURE 150 LB.
 Specific Gravity .600 Pressure Connections at Flange. Pressure Base 4 oz.
 Base and Flowing Temperature 60 deg. Fahr. Atmospheric Pressure 14.4 lb.
 All capacities expressed in thousands of cubic feet.

Differential in Inches of Water	Diameter of Orifice in Inches												
	1/2	5/8	3/4	7/8	1	1 1/4	1 1/2	1 3/4	2	2 1/4	1 1/2	2 3/4	3
1	.85	1.33	1.92	2.60	3.41	5.3	7.7	10.4	13.8	18.0	23.2	29.7	38.
1.5	1.05	1.63	2.35	3.18	4.19	6.6	9.4	12.9	16.9	22.0	28.4	36.4	46.
2	1.21	1.88	2.71	3.68	4.84	7.6	10.9	14.8	19.5	25.5	32.8	42.1	54.
3	1.48	2.31	3.33	4.50	5.9	9.3	13.3	18.2	23.9	31.2	40.2	52.	65.
4	1.71	2.66	3.84	5.1	6.8	10.7	15.4	21.0	27.6	36.0	46.4	59.	76.
6	2.10	3.26	4.70	6.4	8.4	13.1	18.9	25.7	33.8	44.1	57.	73.	93.
8	2.42	3.77	5.4	7.4	9.7	15.1	21.8	29.7	39.0	51.	66.	84.	107.
10	2.71	4.21	6.1	8.2	10.8	16.9	24.3	33.2	43.6	57.	73.	94.	120.
15	3.32	5.2	7.4	10.1	13.2	20.7	29.8	40.7	53.	70.	90.	115.	146.
20	3.83	6.0	8.6	11.6	15.3	23.9	34.4	47.0	62.	80.	104.	133.	169.
30	4.69	7.3	10.5	14.2	18.7	29.3	42.2	58.	76.	99.	127.	163.	207.
40	5.4	8.4	12.1	16.4	21.6	33.8	48.7	66.	87.	114.	147.	188.	239.
50	6.1	9.4	13.6	18.4	24.2	37.8	54.	74.	98.	127.	164.	210.	267.
60	6.6	10.3	14.9	20.1	26.5	41.4	60.	81.	107.	139.	180.	230.	293.
80	7.7	11.9	17.2	23.3	30.6	47.9	69.	94.	123.	161.	208.	266.	338.
100	8.5	13.3	19.2	26.0	34.1	53.	77.	104.	138.	180.	232.	297.	380.

Table 121
4 INCH LINE HOURLY CAPACITIES OF ORIFICES PRESSURE 200 LB.
 Specific Gravity .600 Pressure Connections at Flange. Pressure Base 4 oz.
 Base and Flowing Temperature 60 deg. fahr. Atmospheric Pressure 14.4 lb.
 All capacities expressed in thousands of cubic feet.

Differential in Inches of Water	Diameter of Orifice in Inches												
	1/2	5/8	3/4	7/8	1	1 1/4	1 1/2	1 3/4	2	2 1/4	2 1/2	2 3/4	3
1	.97	1.52	2.19	2.98	3.9	6.1	8.8	11.9	15.8	20.6	26.5	33.9	43.
1.5	1.19	1.86	2.69	3.64	4.8	7.4	10.7	14.6	19.3	25.2	32.5	41.5	53.
2	1.37	2.14	3.11	4.21	5.5	8.6	12.3	16.8	22.3	29.1	37.5	47.9	61.
3	1.68	2.62	3.81	5.2	6.8	10.5	15.1	20.6	27.3	35.7	45.9	59.	75.
4	1.94	3.03	4.40	5.9	7.8	12.1	17.4	23.8	31.5	41.2	52.	68.	86.
6	2.38	3.71	5.4	7.3	9.6	14.8	21.4	29.1	38.6	50.	65.	83.	106.
8	2.75	4.29	6.2	8.4	11.0	17.1	24.7	33.7	44.6	58.	75.	96.	122.
10	3.07	4.79	7.0	9.4	12.3	19.2	27.6	37.6	49.8	65.	84.	107.	137.
15	3.76	5.9	8.5	11.5	15.1	23.5	33.8	46.1	61.	80.	103.	131.	167.
20	4.35	6.8	9.8	13.3	17.4	27.1	39.0	53.	70.	92.	119.	152.	193.
30	5.3	8.3	12.0	16.3	21.4	33.2	47.8	65.	86.	113.	145.	186.	237.
40	6.1	9.6	13.9	18.8	24.7	38.3	55.	75.	100.	130.	168.	214.	273.
50	6.9	10.7	15.6	21.0	27.6	42.9	62.	84.	111.	146.	187.	240.	305.
60	7.5	11.7	17.0	23.0	30.2	46.9	68.	92.	122.	160.	205.	263.	335.
80	8.7	13.6	19.7	26.6	34.9	54.	78.	106.	141.	184.	237.	303.	386.
100	9.7	15.2	21.9	29.8	39.0	61.	88.	119.	158.	206.	265.	339.	430.

Table 122
4 INCH LINE HOURLY CAPACITIES OF ORIFICES PRESSURE 300 LB.
 Specific Gravity .600 Pressure Connections at Flange. Pressure Base 4 oz.
 Base and Flowing Temperature 60 deg. Fahr. Atmospheric Pressure 14.4 lb.

All capacities expressed in thousands of cubic feet.

Differential in Inches of Water	Diameter of Orifice in Inches												
	1/2	5/8	3/4	7/8	1	1 1/4	1 1/2	1 3/4	2	2 1/4	2 1/2	2 3/4	3
1	1.17	1.84	2.65	3.6	4.7	7.4	10.6	14.4	19.1	24.9	32.1	41.	52.
1.5	1.45	2.26	3.25	4.4	5.8	9.0	13.0	17.6	23.5	30.6	39.3	50.	64.
2	1.67	2.61	3.75	5.1	6.7	10.4	15.0	20.4	27.1	35.3	45.4	58.	74.
3	2.04	3.20	4.59	6.2	8.2	12.7	18.4	24.9	33.3	43.3	56.	71.	91.
4	2.36	3.69	5.2	7.2	9.4	14.7	21.2	28.8	38.4	50.	64.	82.	105.
6	2.87	4.52	6.5	8.8	11.6	18.0	26.0	35.3	47.0	61.	79.	101.	129.
8	3.34	5.2	7.5	10.2	13.4	20.8	30.0	40.7	54.	70.	91.	117.	148.
10	3.73	5.8	8.4	11.4	14.9	23.2	33.5	45.5	61.	79.	102.	130.	166.
15	4.57	7.1	10.3	13.9	18.3	28.5	41.1	56.	74.	96.	124.	160.	203.
20	5.3	8.3	11.9	16.1	21.1	32.9	47.4	64.	86.	111.	144.	184.	235.
30	6.5	10.0	14.5	19.7	25.9	40.3	58.	79.	105.	136.	176.	226.	288.
40	7.5	11.7	16.8	22.8	29.9	46.5	67.	91.	121.	158.	203.	261.	332.
50	8.3	13.0	18.7	25.5	33.4	52.	75.	102.	136.	176.	227.	291.	371.
60	9.1	14.3	20.5	27.9	36.6	57.	82.	112.	149.	193.	249.	319.	407.
80	10.6	16.5	23.7	32.2	42.2	66.	95.	129.	172.	223.	287.	369.	470.
100	11.7	18.4	26.5	36.0	47.0	74.	106.	144.	191.	249.	321.	410.	520.

Table 123
4 INCH LINE HOURLY CAPACITIES OF ORIFICES PRESSURE 400 LB.
 Specific Gravity .600 Pressure Connections at Flange. Pressure Base 4 oz.
 Base and Flowing Temperature 60 deg. Fahr. Atmospheric Pressure 14.4 lb.
 All capacities expressed in thousands of cubic feet.

Differential in Inches of Water	Diameter of Orifice in Inches												
	1/2	5/8	3/4	7/8	1	1 1/4	1 1/2	1 3/4	2	2 1/4	2 1/2	2 3/4	3
1	1.35	2.11	3.04	4.1	5.4	8.4	12.1	16.5	21.9	28.6	37.	47.	60.
1.5	1.66	2.60	3.75	5.1	6.6	10.4	14.8	20.4	26.9	35.2	45.	58.	73.
2	1.92	3.00	4.33	5.9	7.6	12.0	17.1	23.5	31.1	40.7	52.	67.	85.
3	2.35	3.67	5.3	7.2	9.4	14.7	21.0	28.8	38.1	49.8	64.	82.	104.
4	2.71	4.24	6.1	8.3	10.8	17.0	24.2	33.3	44.0	57.	74.	94.	120.
6	3.32	5.2	7.5	10.2	13.2	20.8	29.7	40.8	54.	70.	90.	116.	147.
8	3.84	6.0	8.7	11.8	15.3	24.0	34.3	47.1	62.	87.	104.	134.	170.
10	4.29	6.7	9.7	13.2	17.1	26.8	38.3	53.	70.	91.	117.	149.	190.
15	5.3	8.2	11.9	16.1	20.9	32.8	46.9	64.	85.	111.	143.	183.	232.
20	6.1	9.5	13.7	18.6	24.1	37.9	54.	74.	98.	129.	165.	211.	268.
30	7.4	11.6	16.8	22.8	29.6	46.4	66.	91.	120.	157.	202.	259.	329.
40	8.6	13.4	19.4	26.3	34.2	54.	77.	105.	139.	182.	233.	299.	379.
50	9.6	15.0	21.6	29.4	38.2	60.	86.	118.	156.	203.	261.	334.	424.
60	10.5	16.4	23.7	32.2	41.8	66.	94.	129.	170.	223.	286.	366.	465.
80	12.1	19.0	27.4	37.2	48.3	76.	108.	149.	197.	257.	330.	422.	540.
100	13.5	21.1	30.4	41.4	54.	84.	121.	165.	219.	286.	370.	472.	600.

Table 124
6 INCH LINE HOURLY CAPACITIES OF ORIFICES PRESSURE 0 LB.
 Specific Gravity .600 Pressure Connections at Flange. Pressure Base 4 oz.
 Base and Flowing Temperature 60 deg. Fahr. Atmospheric Pressure 14.4 lb.
 All capacities expressed in thousands of cubic feet.

Differential in Inches of Water	Diameter of Orifice in Inches												
	3/4	1	1 1/4	1 1/2	1 3/4	2	2 1/4	2 1/2	2 3/4	3	3 1/2	4	4 1/2
.10	.180	.319	.50	.71	.98	1.28	1.63	1.97	2.41	2.93	4.1	5.7	7.9
.15	.221	.391	.61	.88	1.20	1.56	1.99	2.44	2.96	3.59	5.1	7.0	9.6
.20	.255	.452	.70	1.01	1.38	1.81	2.30	2.82	3.41	4.15	5.8	8.1	11.1
.30	.312	.55	.86	1.24	1.69	2.21	2.82	3.45	4.18	5.1	7.2	9.9	13.6
.40	.361	.64	1.00	1.43	1.95	2.56	3.26	3.98	4.83	5.9	8.3	11.5	15.8
.50	.403	.71	1.11	1.60	2.18	2.86	3.64	4.46	5.4	6.6	9.2	12.8	17.6
.60	.442	.78	1.22	1.75	2.39	3.12	3.99	4.88	5.9	7.2	10.1	14.1	19.3
.80	.51	.90	1.41	2.02	2.76	3.61	4.61	5.6	6.8	8.3	11.7	16.2	22.3
1	.57	1.00	1.58	2.26	3.09	4.0	5.1	6.3	7.6	9.2	13.0	18.2	25.0
1.5	.70	1.24	1.93	2.77	3.78	5.0	6.3	7.7	9.3	11.4	16.0	22.2	30.6
2	.81	1.43	2.23	3.20	4.37	5.7	7.3	8.9	10.8	13.1	18.5	25.7	35.3
3	.99	1.75	2.73	3.91	5.4	7.0	8.9	10.9	13.2	16.1	22.7	31.4	43.3
4	1.14	2.02	3.15	4.52	6.2	8.1	10.3	12.6	15.3	18.5	26.2	36.3	50.
6	1.40	2.47	3.86	5.5	7.6	9.9	12.6	15.4	18.7	22.7	32.0	44.5	61.
8	1.61	2.86	4.46	6.4	8.7	11.4	14.6	17.8	21.6	26.2	37.0	51.	70.
10	1.80	3.19	4.98	7.1	9.8	12.8	16.3	19.7	24.1	29.3	41.4	57.	79.
15	2.21	3.91	6.1	8.8	12.0	15.6	19.9	24.4	29.6	35.9	51.	70.	96.
20	2.55	4.52	7.0	10.1	13.8	18.1	23.0	28.2	34.1	41.5	58.	81.	111.
30	3.12	5.5	8.6	12.4	16.9	22.1	28.2	34.5	41.8	51.	72.	99.	136.
40	3.61	6.4	10.0	14.3	19.5	25.6	32.6	39.8	48.3	59.	83.	115.	158.
50	4.03	7.1	11.1	16.0	21.8	28.6	36.4	44.6	54.	66.	92.	128.	176.

Table 125
6 INCH LINE HOURLY CAPACITIES OF ORIFICES **PRESSURE 10 LB.**
 Specific Gravity .600 Pressure Connections at Flange. Pressure Base 4 oz.
 Base and Flowing Temperature 60 deg. Fahr. Atmospheric Pressure 14.4 lb.
 All capacities expressed in thousands of cubic feet.

Differential in Inches of Water	Diameter of Orifice in Inches												
	¾	1	1¼	1½	1¾	2	2¼	2½	2¾	3	3½	4	4½
.10	.235	.41	.65	.93	1.28	1.66	2.11	2.61	3.1	3.7	5.4	7.5	10.3
.15	.287	.51	.80	1.14	1.56	2.03	2.59	3.19	3.8	4.6	6.6	9.2	12.7
.20	.332	.58	.92	1.32	1.81	2.35	2.98	3.69	4.4	5.3	7.6	10.6	14.6
.30	.406	.72	1.13	1.62	2.21	2.88	3.65	4.51	5.4	6.5	9.3	13.0	17.9
.40	.469	.83	1.30	1.87	2.56	3.32	4.21	5.2	6.3	7.5	10.7	15.1	20.7
.50	.52	.92	1.46	2.09	2.86	3.71	4.71	5.8	7.0	8.3	12.0	16.8	23.1
.60	.57	1.01	1.60	2.29	3.12	4.07	5.2	6.4	7.7	9.1	13.1	18.4	25.3
.80	.66	1.17	1.84	2.64	3.61	4.70	6.0	7.4	8.9	10.6	15.2	21.3	29.2
1	.74	1.31	2.05	2.95	4.0	5.2	6.7	8.2	9.9	11.8	17.0	23.7	32.6
1.5	.91	1.60	2.52	3.61	5.0	6.4	8.2	10.1	12.1	14.5	20.8	29.1	40.0
2	1.05	1.85	2.91	4.17	5.7	7.4	9.4	11.7	14.0	16.7	24.0	33.7	46.2
3	1.29	2.27	3.57	5.1	7.0	9.1	11.5	14.3	17.1	20.4	29.4	41.2	57.
4	1.48	2.62	4.12	5.9	8.1	10.5	13.3	16.5	19.8	23.6	33.9	47.6	65.
6	1.82	3.20	5.0	7.2	9.9	12.9	16.3	20.2	24.2	28.9	41.5	58.	80.
8	2.10	3.70	5.8	8.3	11.4	14.8	18.8	23.3	28.0	33.4	47.9	67.	92.
10	2.35	4.14	6.5	9.3	12.8	16.6	21.1	26.1	31.3	37.3	54.	75.	103.
15	2.87	5.1	8.0	11.4	15.6	20.3	25.9	31.9	38.3	45.7	66.	92.	127.
20	3.32	5.8	9.2	13.2	18.1	23.5	29.8	36.9	44.3	53.	76.	106.	146.
30	4.06	7.2	11.3	16.2	22.1	28.8	36.5	45.1	54.	65.	93.	130.	179.
40	4.69	8.3	13.0	18.7	25.6	33.2	42.1	52.	63.	75.	107.	151.	207.
50	5.2	9.2	14.6	20.9	28.6	37.1	47.1	58.	70.	83.	120.	168.	231.

Table 126
6 INCH LINE HOURLY CAPACITIES OF ORIFICES PRESSURE 20 LB.
 Specific Gravity .600 Pressure Connections at Flange. Pressure Base 4 oz.
 Base and Flowing Temperature 60 deg. Fahr. Atmospheric Pressure 14.4 lb.

All capacities expressed in thousands of cubic feet.

Differential in Inches of Water	Diameter of Orifice in Inches												
	¾	1	1¼	1½	1¾	2	2¼	2½	2¾	3	3½	4	4½
.4	.55	.99	1.54	2.22	3.01	3.95	5.0	6.1	7.5	9.0	12.8	17.9	24.5
.5	.62	1.10	1.73	2.48	3.37	4.41	5.6	6.9	8.3	10.1	14.3	20.0	27.4
.6	.68	1.21	1.89	2.72	3.69	4.83	6.1	7.5	9.1	11.1	15.6	21.9	30.0
.8	.78	1.40	2.18	3.14	4.26	5.6	7.1	8.7	10.6	12.8	18.1	25.3	34.6
1	.87	1.56	2.44	3.51	4.8	6.2	7.9	9.7	11.8	14.2	20.2	28.1	38.7
1.5	1.07	1.91	2.99	4.30	5.8	7.6	9.7	11.9	14.5	17.5	24.7	34.6	47.4
2	1.23	2.21	3.45	4.96	6.7	8.8	11.2	13.7	16.7	20.2	28.6	39.9	55.
3	1.51	2.70	4.23	6.1	8.2	10.8	13.7	16.8	20.4	24.7	35.0	48.9	67.
4	1.74	3.12	4.88	7.0	9.5	12.5	15.8	19.4	23.6	28.6	40.4	56.	77.
6	2.14	3.82	6.0	8.6	11.7	15.3	19.4	23.8	28.7	35.0	49.5	69.	95.
8	2.47	4.41	6.9	9.9	13.5	17.6	22.4	27.5	33.4	40.4	57.	80.	109.
10	2.76	4.93	7.7	11.1	15.1	19.7	25.0	30.7	37.3	45.2	64.	89.	122.
15	3.38	6.0	9.5	13.6	18.4	24.2	30.6	37.6	45.7	55.	78.	109.	150.
20	3.90	7.0	10.9	15.7	21.3	27.9	35.4	43.5	53.	64.	90.	126.	173.
30	4.78	8.5	13.4	19.2	26.1	34.2	43.3	53.	65.	78.	111.	155.	212.
40	5.5	9.9	15.4	22.2	30.1	39.5	50.	61.	75.	90.	128.	179.	245.
50	6.2	11.0	17.3	24.8	33.7	44.1	56.	69.	83.	101.	143.	200.	274.
60	6.8	12.1	18.9	27.2	36.9	48.3	61.	75.	91.	111.	156.	219.	300.
80	7.8	14.0	21.8	31.4	42.6	56.	71.	87.	106.	128.	181.	253.	346.
100	8.7	15.6	24.4	35.1	48.0	62.	79.	97.	118.	142.	202.	281.	387.

Table 127
6 INCH LINE HOURLY CAPACITIES OF ORIFICES PRESSURE 40 LB.
 Specific Gravity .600 Pressure Connections at Flange. Pressure Base 4 oz.
 Base and Flowing Temperature 60 deg. Fahr. Atmospheric Pressure 14.4 lb.
 All capacities expressed in thousands of cubic feet.

Differential in Inches of Water	Diameter of Orifice in Inches												
	¾	1	1¼	1½	1¾	2	2¼	2½	2¾	3	3½	4	4½
1	1.10	1.96	3.06	4.4	6.0	7.8	9.9	12.2	14.8	17.9	25.4	35.4	49.
1.5	1.35	2.41	3.75	5.4	7.3	9.6	12.1	15.0	18.2	21.9	31.2	43.4	60.
2	1.56	2.78	4.33	6.2	8.5	11.1	14.0	17.3	21.0	25.2	36.1	50.	69.
3	1.91	3.40	5.3	7.6	10.4	13.6	17.1	21.2	25.8	30.9	44.2	61.	85.
4	2.20	3.93	6.1	8.8	12.0	15.7	19.8	24.5	29.8	35.7	50.	71.	98.
6	2.69	4.81	7.5	10.8	14.7	19.2	24.2	30.0	36.4	43.7	62.	87.	120.
8	3.11	5.6	8.7	12.4	17.0	22.2	28.0	34.6	42.1	50.	72.	100.	138.
10	3.48	6.2	9.7	13.9	19.0	24.8	31.3	38.7	47.1	56.	81.	112.	154.
15	4.26	7.6	11.9	17.0	23.2	30.4	38.3	47.4	58.	69.	99.	137.	189.
20	4.92	8.8	13.7	19.7	26.8	35.1	44.3	55.	67.	80.	114.	158.	218.
30	6.0	10.8	16.8	24.1	32.9	42.9	54.	67.	82.	98.	140.	194.	267.
40	7.0	12.4	19.4	27.8	37.9	49.6	63.	77.	94.	113.	161.	224.	309.
50	7.8	13.9	21.6	31.1	42.4	55.	70.	87.	105.	126.	180.	250.	345.
60	8.5	15.2	23.7	34.1	46.5	61.	77.	95.	115.	138.	198.	274.	378.
80	9.8	17.6	27.4	39.4	54.	70.	89.	109.	133.	160.	228.	317.	436.
100	11.0	19.6	30.6	44.	60.	78.	99.	122.	148.	179.	254.	354.	490.

Table 128
6 INCH LINE HOURLY CAPACITIES OF ORIFICES PRESSURE 60 LB.
 Specific Gravity .600 Pressure Connections at Flange. Pressure Base 4 oz.
 Base and Flowing Temperature 60 deg. Fahr. Atmospheric Pressure 14.4 lb.
 All capacities expressed in thousands of cubic feet.

Differential in Inches of Water	Diameter of Orifice in Inches												
	3/4	1	1 1/4	1 1/2	1 3/4	2	2 1/4	2 1/2	2 3/4	3	3 1/2	4	4 1/2
1	1.29	2.29	3.6	5.2	7.0	9.2	11.6	14.3	17.3	20.9	29.7	41.	57.
1.5	1.59	2.82	4.4	6.3	8.5	11.2	14.2	17.5	21.3	25.7	36.4	51.	70.
2	1.83	3.25	5.1	7.3	9.8	13.0	16.4	20.2	24.6	29.7	42.1	59.	81.
3	2.25	3.98	6.2	8.9	12.1	15.9	20.1	24.7	30.1	36.4	52.	72.	99.
4	2.59	4.60	7.1	10.3	14.0	18.4	23.2	28.6	34.8	42.0	59.	83.	114.
6	3.17	5.6	8.7	12.6	17.1	22.5	28.4	35.0	42.6	51.	73.	102.	140.
8	3.67	6.5	10.1	14.6	19.7	26.0	32.8	40.4	49.2	59.	84.	118.	161.
10	4.10	7.3	11.3	16.3	22.1	29.0	36.7	45.2	55.	66.	94.	132.	180.
15	5.0	8.9	13.8	19.9	27.1	35.6	44.9	55.	67.	81.	115.	161.	221.
20	5.8	10.3	16.0	23.0	31.3	41.1	52.	64.	78.	94.	133.	186.	255.
30	7.1	12.6	19.6	28.2	38.3	50.	64.	78.	95.	115.	163.	228.	312.
40	8.2	14.5	22.6	32.6	44.2	58.	73.	90.	110.	133.	188.	263.	361.
50	9.2	16.3	25.2	36.4	49.4	65.	82.	101.	123.	148.	210.	294.	403.
60	10.0	17.8	27.7	39.9	54.	71.	90.	111.	135.	163.	230.	322.	442.
80	11.6	20.6	31.9	46.1	62.	82.	104.	128.	156.	188.	266.	372.	510.
100	12.9	22.9	35.8	52.	70.	92.	116.	143.	173.	209.	297.	414.	570.

Table 129
6 INCH LINE HOURLY CAPACITIES OF ORIFICES PRESSURE 100 LB.
 Specific Gravity .600 Pressure Connections at Flange. Pressure Base 4 oz.
 Base and Flowing Temperature 60 deg. fahr. Atmospheric Pressure 14.4 lb.
 All capacities expressed in thousands of cubic feet.

Differential in Inches of Water	Diameter of Orifice in Inches												
	3/4	1	1 1/4	1 1/2	1 3/4	2	2 1/4	2 1/2	2 3/4	3	3 1/2	4	4 1/2
1	1.60	2.84	4.4	6.4	8.7	11.3	14.4	17.8	21.5	25.9	37.	51.	71.
1.5	1.97	3.49	5.4	7.9	10.7	14.0	17.6	21.9	26.4	31.8	45.	63.	87.
2	2.27	4.03	6.3	9.1	12.3	16.1	20.4	25.2	30.5	36.8	52.	73.	100.
3	2.78	4.94	7.7	11.1	15.1	19.7	24.9	30.9	37.4	45.0	64.	89.	122.
4	3.21	5.7	8.9	12.8	17.4	22.8	28.8	35.7	43.2	51.	74.	103.	141.
6	3.93	7.0	10.9	15.7	21.4	27.9	35.3	43.7	53.	64.	90.	126.	173.
8	4.54	8.1	12.6	18.2	24.7	32.2	40.7	50.	61.	74.	104.	146.	200.
10	5.1	9.0	14.0	20.3	27.6	36.1	45.5	56.	68.	82.	117.	163.	224.
15	6.2	11.0	17.2	24.9	33.8	44.2	56.	69.	84.	101.	143.	199.	274.
20	7.2	12.7	19.9	28.7	39.0	51.	64.	80.	97.	116.	165.	230.	316.
30	8.8	15.6	24.3	35.2	47.8	62.	79.	98.	118.	142.	202.	282.	387.
40	10.2	18.0	28.1	40.6	55.	72.	91.	113.	137.	164.	233.	326.	447.
50	11.3	20.2	31.4	45.4	62.	81.	102.	126.	153.	184.	261.	364.	500.
60	12.4	22.1	34.4	49.7	68.	88.	112.	138.	167.	201.	286.	399.	550.
80	14.4	25.5	39.7	57.	78.	102.	129.	160.	193.	233.	330.	461.	630.
100	16.0	28.4	44.4	64.	87.	113.	144.	178.	215.	259.	369.	510.	710.

Table 130
6 INCH LINE HOURLY CAPACITIES OF ORIFICES PRESSURE 150 LB.
 Specific Gravity .600 Pressure Connections at Flange. Pressure Base 4 oz.
 Base and Flowing Temperature 60 deg. Fahr. Atmospheric Pressure 14.4 lb.

All capacities expressed in thousands of cubic feet.

Differential in Inches of Water	Diameter of Orifice in Inches												
	¾	1	1¼	1½	1¾	2	2¼	2½	2¾	3	3½	4	4½
1	1.92	3.41	5.3	7.7	10.4	13.6	17.3	21.3	25.9	31.	44.	62.	85.
1.5	2.35	4.19	6.6	9.4	12.7	16.8	21.1	26.2	31.8	38.	54.	76.	104.
2	2.71	4.84	7.6	10.9	14.7	19.3	24.4	30.3	36.8	44.	62.	87.	120.
3	3.33	5.9	9.3	13.3	18.0	23.7	29.9	37.1	45.0	54.	76.	107.	147.
4	3.84	6.8	10.7	15.4	20.8	27.4	34.5	42.8	51.	62.	88.	124.	170.
6	4.70	8.4	13.1	18.9	25.5	33.5	42.3	52.	64.	76.	108.	151.	208.
8	5.4	9.7	15.1	21.8	29.4	38.7	48.8	61.	74.	88.	124.	175.	240.
10	6.1	10.8	16.9	24.3	32.9	43.3	55.	68.	82.	99.	139.	195.	268.
15	7.4	13.2	20.7	29.8	40.3	53.	67.	83.	101.	121.	170.	239.	328.
20	8.6	15.3	23.9	34.4	46.5	61.	77.	96.	116.	140.	197.	276.	379.
30	10.5	18.7	29.3	42.2	57.	75.	94.	117.	142.	171.	241.	338.	464.
40	12.1	21.6	33.8	48.7	66.	87.	109.	135.	164.	197.	278.	391.	540.
50	13.6	24.2	37.8	54.	74.	97.	122.	151.	184.	221.	311.	437.	600.
60	14.9	26.5	41.4	60.	81.	106.	134.	166.	201.	242.	341.	479.	660.
80	17.2	30.6	47.9	69.	93.	122.	154.	191.	233.	279.	394.	550.	760.
100	19.2	34.1	53.	77.	104.	136.	173.	213.	259.	311.	444.	620.	850.

Table 131
6 INCH LINE HOURLY CAPACITIES OF ORIFICES PRESSURE 200 LB.
 Specific Gravity .600 Pressure Connections at Flange. Pressure Base 4 oz.
 Base and Flowing Temperature 60 deg. Fahr. Atmospheric Pressure 14.4 lb.
 All capacities expressed in thousands of cubic feet.

Differential in Inches of Water	Diameter of Orifice in Inches												
	¾	1	1¼	1½	1¾	2	2¼	2½	2¾	3	3½	4	4½
1	2.19	3.9	6.1	8.8	11.9	15.6	19.7	24.3	29.4	36.	50.	70.	97.
1.5	2.67	4.8	7.4	10.7	14.6	19.1	24.1	29.9	36.1	47.	62.	85.	118.
2	3.11	5.5	8.6	12.3	16.8	22.1	27.8	34.5	41.7	51.	71.	98.	136.
3	3.81	6.8	10.5	15.1	20.6	27.0	34.0	42.3	51.	62.	87.	121.	167.
4	4.40	7.8	12.1	17.4	23.8	31.2	39.3	48.8	59.	71.	101.	140.	193.
6	5.4	9.6	14.8	21.4	29.1	38.2	48.1	60.	72.	87.	124.	171.	236.
8	6.2	11.0	17.1	24.7	33.7	44.1	56.	69.	83.	101.	143.	197.	272.
10	7.0	12.3	19.2	27.6	37.6	49.3	62.	77.	93.	113.	160.	221.	305.
15	8.5	15.1	23.5	33.8	46.1	60.	76.	95.	114.	138.	196.	271.	373.
20	9.8	17.4	27.1	39.0	53.	70.	88.	109.	132.	160.	226.	313.	431.
30	12.0	21.4	33.2	47.8	65.	85.	108.	134.	162.	196.	277.	383.	530.
40	13.9	24.7	38.3	55.	75.	99.	124.	154.	187.	226.	319.	442.	610.
50	15.6	27.6	42.9	62.	84.	110.	139.	173.	209.	252.	357.	494.	680.
60	17.0	30.2	46.9	68.	92.	121.	152.	189.	229.	277.	391.	540.	750.
80	19.7	34.9	54.	78.	106.	140.	176.	218.	264.	319.	452.	630.	860.
100	21.9	39.0	61.	88.	119.	156.	197.	243.	294.	360.	500.	700.	970.

ORIFICE CAPACITIES FOR GAS

Table 132
6 INCH LINE HOURLY CAPACITIES OF ORIFICES PRESSURE 300 LB.
 Specific Gravity .600 Pressure Connections at Flange. Pressure Base 4 oz.
 Base and Flowing Temperature 60 deg. Fahr. Atmospheric Pressure 14.4 lb.
 All capacities expressed in thousands of cubic feet.

Differential in Inches of Water	Diameter of Orifice in Inches												
	¾	1	1¼	1½	1¾	2	2¼	2½	2¾	3	3½	4	4½
1	2.65	4.7	7.4	10.6	14.4	18.9	23.9	29.5	36.	43.	61.	85.	117.
1.5	3.25	5.8	9.0	13.0	17.6	23.1	29.1	36.1	44.	53.	75.	104.	143.
2	3.75	6.7	10.4	15.0	20.4	26.7	33.7	41.7	51.	61.	87.	120.	165.
3	4.59	8.2	12.7	18.4	24.9	32.7	41.2	51.	62.	75.	106.	147.	203.
4	5.2	9.4	14.7	21.2	28.8	37.8	47.6	59.	71.	86.	122.	170.	234.
6	6.5	11.6	18.0	26.0	35.3	46.3	58.	72.	87.	106.	150.	208.	287.
8	7.5	13.4	20.8	30.0	40.7	53.	67.	83.	101.	122.	173.	240.	331.
10	8.4	14.9	23.2	33.5	45.5	60.	75.	93.	113.	137.	194.	268.	370.
15	10.3	18.3	28.5	41.1	56.	73.	92.	114.	138.	167.	237.	328.	453.
20	11.9	21.1	32.9	47.4	64.	85.	106.	132.	160.	193.	274.	379.	520.
30	14.5	25.9	40.3	58.	79.	104.	130.	162.	196.	237.	335.	464.	640.
40	16.8	29.9	46.5	67.	91.	120.	151.	187.	226.	273.	387.	540.	740.
50	18.7	33.4	52.	75.	102.	134.	168.	209.	252.	305.	433.	600.	830.
60	20.5	36.6	57.	82.	112.	146.	184.	229.	277.	335.	474.	660.	910.
80	23.7	42.2	66.	95.	129.	169.	213.	264.	319.	386.	550.	760.	1050.
100	26.5	47.	74.	106.	144.	189.	239.	295.	360.	430.	610.	850.	1170.

Table 133
6 INCH LINE HOURLY CAPACITIES OF ORIFICES PRESSURE 400 LB.
 Specific Gravity .600 Pressure Connections at Flange. Pressure Base 4 oz.
 Base and Flowing Temperature 60 deg. Fahr. Atmospheric Pressure 14.4 lb.
 All capacities expressed in thousands of cubic feet.

Differential in Inches of Water	Diameter of Orifice in Inches												
	¾	1	1¼	1½	1¾	2	2¼	2½	2¾	3	3½	4	4½
1	3.04	5.4	8.4	12.1	16.5	21.6	27.4	33.8	41.0	49.	70.	98.	134.
1.5	3.75	6.6	10.4	14.8	20.2	26.4	33.7	41.5	50.	61.	85.	120.	165.
2	4.33	7.6	12.0	17.1	23.3	30.5	38.9	47.9	58.	70.	98.	139.	190.
3	5.3	9.4	14.7	21.0	28.6	37.4	47.6	59.	71.	86.	121.	170.	233.
4	6.1	10.8	17.0	24.2	33.0	43.2	55.	68.	82.	99.	140.	196.	269.
6	7.5	13.2	20.8	29.7	40.4	53.	67.	83.	101.	121.	171.	240.	329.
8	8.7	15.3	24.0	34.3	46.7	61.	78.	96.	117.	140.	197.	277.	380.
10	9.7	17.1	26.8	38.3	52.	68.	87.	107.	130.	157.	221.	310.	425.
15	11.9	20.9	32.8	46.9	64.	84.	107.	131.	160.	192.	271.	380.	520.
20	13.7	24.1	37.9	54.	74.	97.	123.	152.	184.	222.	313.	439.	600.
30	16.8	29.6	46.4	66.	90.	118.	151.	186.	226.	272.	383.	540.	740.
40	19.4	34.2	54.	77.	104.	137.	174.	214.	261.	314.	442.	620.	850.
50	21.6	38.2	60.	86.	117.	153.	194.	240.	291.	351.	494.	690.	950.
60	23.7	41.8	66.	94.	128.	167.	213.	263.	319.	384.	540.	760.	1040.
80	27.4	48.3	76.	108.	148.	193.	246.	303.	369.	444.	630.	880.	1200.
100	30.4	54.	84.	121.	165.	216.	274.	338.	410.	490.	700.	980.	1340.

ORIFICE CAPACITIES FOR GAS

Table 134
8 INCH LINE HOURLY CAPACITIES OF ORIFICES PRESSURE 0 LB.
 Specific Gravity .600 Pressure Connections at Flange. Pressure Base 4 oz.
 Base and Flowing Temperature 60 deg. Fahr. Atmospheric Pressure 14.4 lb.
 All capacities expressed in thousands of cubic feet.

Differential in Inches of Water	Diameter of Orifice in Inches														
	1	1¼	1½	1¾	2	2¼	2½	2¾	3	3½	4	4½	5	5½	6
.10	.319	.50	.71	.98	1.28	1.63	1.97	2.41	2.87	3.9	5.2	6.8	8.7	11.1	14.2
.15	.391	.61	.88	1.20	1.56	1.99	2.44	2.96	3.52	4.8	6.3	8.3	10.7	13.6	17.4
.20	.452	.70	1.01	1.38	1.81	2.30	2.82	3.41	4.07	5.5	7.3	9.6	12.3	15.7	20.0
.30	.55	.86	1.24	1.69	2.21	2.82	3.45	4.18	4.98	6.8	9.0	11.7	15.1	19.2	24.5
.40	.64	1.00	1.43	1.95	2.56	3.26	3.98	4.83	5.7	7.8	10.3	13.5	17.4	22.2	28.3
.50	.71	1.11	1.60	2.18	2.86	3.64	4.46	5.4	6.4	8.7	11.6	15.1	19.4	24.8	31.7
.60	.78	1.22	1.75	2.39	3.12	3.99	4.88	5.9	7.0	9.6	12.7	16.6	21.3	27.2	34.7
.80	.90	1.41	2.02	2.76	3.61	4.61	5.6	6.8	8.1	11.1	14.6	19.1	24.6	31.4	40.1
1	1.00	1.58	2.26	3.09	4.04	5.1	6.3	7.6	9.1	12.3	16.3	21.3	27.5	35.1	44.6
1.5	1.24	1.93	2.77	3.78	4.95	6.3	7.7	9.3	11.1	15.1	20.0	26.2	33.7	43.0	55.
2	1.43	2.23	3.20	4.37	5.7	7.3	8.9	10.8	12.9	17.5	23.1	30.3	38.9	49.6	63.
3	1.75	2.73	3.91	5.4	7.0	8.9	10.9	13.2	15.7	21.4	28.3	37.1	47.6	61.	78.
4	2.02	3.15	4.52	6.2	8.1	10.3	12.6	15.3	18.2	24.7	32.7	42.8	55.	70.	90.
6	2.47	3.86	5.5	7.6	9.9	12.6	15.4	18.7	22.3	30.3	40.0	52.	67.	86.	110.
8	2.86	4.46	6.4	8.7	11.4	14.6	17.8	21.6	25.7	35.0	46.2	61.	78.	99.	127.
10	3.19	4.98	7.1	9.8	12.8	16.3	19.7	24.1	28.7	39.1	52.	68.	87.	111.	142.
15	3.91	6.1	8.8	12.0	15.6	19.9	24.4	29.6	35.2	47.9	63.	83.	107.	136.	174.
20	4.52	7.0	10.1	13.8	18.1	23.0	28.2	34.1	40.7	55.	73.	96.	123.	157.	200.
30	5.5	8.6	12.4	16.9	22.1	28.2	34.5	41.8	49.8	68.	90.	117.	151.	192.	245.
40	6.4	10.0	14.3	19.5	25.6	32.6	39.8	48.3	57.	78.	103.	135.	174.	222.	283.
50	7.1	11.1	16.0	21.8	28.6	36.4	44.6	54.	64.	87.	116.	151.	194.	248.	317.

ORIFICE CAPACITIES FOR GAS

Table 135
8 INCH LINE HOURLY CAPACITIES OF ORIFICES PRESSURE 10 LB.

Specific Gravity .600
 Base and Flowing Temperature 60 deg. Fahr.
 Pressure Connections at Flange.
 Atmospheric Pressure 14.4 lb.
 Pressure Base 4 oz.
 All capacities expressed in thousands of cubic feet.

Differential in Inches of Water	Diameter of Orifice in Inches														
	1	1¼	1½	1¾	2	2¼	2½	2¾	3	3½	4	4½	5	5½	6
.10	.41	.65	.93	1.28	1.66	2.11	2.61	3.1	3.7	5.1	6.8	8.8	11.3	14.4	18.3
.15	.51	.80	1.14	1.56	2.03	2.59	3.19	3.8	4.6	6.2	8.3	10.7	13.8	17.7	22.5
.20	.58	.92	1.32	1.81	2.35	2.98	3.69	4.4	5.3	7.2	9.6	12.4	16.0	20.4	25.9
.30	.72	1.13	1.62	2.21	2.88	3.65	4.51	5.4	6.5	8.8	11.7	15.2	19.6	25.0	31.8
.40	.83	1.30	1.87	2.56	3.32	4.21	5.2	6.3	7.5	10.2	13.5	17.6	22.6	28.8	36.7
.50	.92	1.46	2.09	2.86	3.71	4.71	5.8	7.0	8.3	11.3	15.1	19.6	25.2	32.2	41.0
.60	1.01	1.60	2.29	3.12	4.07	5.2	6.4	7.7	9.1	12.4	16.6	21.5	27.7	35.3	44.9
.80	1.17	1.84	2.64	3.61	4.70	6.0	7.4	8.9	10.6	14.4	19.1	24.8	31.9	40.8	52.
1	1.31	2.05	2.95	4.0	5.2	6.7	8.2	9.9	11.8	16.1	21.3	27.8	35.8	45.7	58.
1.5	1.60	2.52	3.61	5.0	6.4	8.2	10.1	12.1	14.5	19.7	26.2	34.0	43.7	56.	71.
2	1.85	2.91	4.17	5.7	7.4	9.4	11.7	14.0	16.7	22.7	30.3	39.2	51.	64.	82.
3	2.27	3.57	5.1	7.0	9.1	11.5	14.3	17.1	20.4	27.8	37.1	48.1	62.	79.	100.
4	2.62	4.12	5.9	8.1	10.5	13.3	16.5	19.8	23.6	32.1	42.8	55.	71.	91.	116.
6	3.20	5.0	7.2	9.9	12.9	16.3	20.2	24.2	28.9	39.3	52.	68.	87.	112.	142.
8	3.70	5.8	8.3	11.4	14.8	18.8	23.3	28.0	33.4	45.4	61.	78.	101.	129.	164.
10	4.14	6.5	9.3	12.8	16.6	21.1	26.1	31.3	37.3	51.	68.	88.	113.	144.	183.
15	5.1	8.0	11.4	15.6	20.3	25.9	31.9	38.3	45.7	62.	83.	107.	138.	177.	225.
20	5.8	9.2	13.2	18.1	23.5	29.8	36.9	44.3	53.	72.	96.	124.	160.	204.	259.
30	7.2	11.3	16.2	22.1	28.8	36.5	45.1	54.	65.	88.	117.	152.	196.	250.	318.
40	8.3	13.0	18.7	25.6	33.2	42.1	52.	63.	75.	102.	135.	176.	226.	288.	367.
50	9.2	14.6	20.9	28.6	37.1	47.1	58.	70.	83.	113.	151.	196.	252.	322.	410.

Table 136
8 INCH LINE HOURLY CAPACITIES OF ORIFICES PRESSURE 20 LB.
 Specific Gravity .600 Pressure Connections at Flange. Pressure Base 4 oz.
 Base and Flowing Temperature 60 deg. Fahr. Atmospheric Pressure 14.4 lb.
 All capacities expressed in thousands of cubic feet.

Differential in Inches of Water	Diameter of Orifice in Inches														
	1	1¼	1½	1¾	2	2¼	2½	2¾	3	3½	4	4½	5	5½	6
.40	.99	1.54	2.22	3.01	3.95	5.0	6.1	7.5	8.9	12.0	16.0	20.9	26.8	34.5	44.
.50	1.10	1.73	2.48	3.37	4.41	5.6	6.9	8.3	9.9	13.5	17.9	23.3	30.0	38.5	49.
.60	1.21	1.89	2.72	3.69	4.83	6.1	7.5	9.1	10.9	14.8	19.6	25.6	32.8	42.2	53.
.80	1.40	2.18	3.14	4.26	5.6	7.1	8.7	10.6	12.6	17.0	22.6	29.5	37.9	48.7	62.
1	1.56	2.44	3.51	4.8	6.2	7.9	9.7	11.7	14.0	19.1	25.3	32.9	42.5	54.	69.
1.5	1.91	2.99	4.30	5.8	7.6	9.7	11.9	14.5	17.2	23.3	30.9	40.4	52.	67.	85.
2	2.21	3.45	4.96	6.7	8.8	11.2	13.7	16.7	19.9	26.9	35.7	46.7	60.	77.	98.
3	2.70	4.23	6.1	8.2	10.8	13.7	16.8	20.4	24.3	33.0	43.7	57.	73.	94.	120.
4	3.12	4.88	7.0	9.5	12.5	15.8	19.4	23.6	28.1	38.1	50.	66.	85.	109.	138.
6	3.82	6.0	8.6	11.7	15.3	19.4	23.8	28.7	34.4	46.7	62.	81.	104.	133.	169.
8	4.41	6.9	9.9	13.5	17.6	22.4	27.5	33.4	39.7	54.	71.	93.	120.	154.	195.
10	4.93	7.7	11.1	15.1	19.7	25.	30.7	37.3	44.4	60.	80.	104.	134.	172.	218.
15	6.0	9.5	13.6	18.4	24.2	30.6	37.6	45.7	54.	74.	98.	128.	164.	211.	267.
20	7.0	10.9	15.7	21.3	27.9	35.4	43.5	53.	63.	85.	113.	148.	190.	244.	309.
30	8.5	13.4	19.2	26.1	34.2	43.3	53.	65.	77.	104.	138.	181.	232.	299.	378.
40	9.9	15.4	22.2	30.1	39.5	50.	61.	75.	89.	120.	160.	209.	268.	345.	436.
50	11.0	17.3	24.8	33.7	44.1	56.	69.	83.	99.	135.	179.	233.	300.	385.	488.
60	12.1	18.9	27.2	36.9	48.3	61.	75.	91.	109.	148.	196.	256.	328.	422.	530.
80	14.0	21.8	31.4	42.6	56.	71.	87.	106.	126.	170.	226.	295.	379.	487.	620.
100	15.6	24.4	35.1	48.0	62.	79.	97.	117.	140.	191.	253.	329.	425.	540.	690.

Table 137
8 INCH LINE HOURLY CAPACITIES OF ORIFICES PRESSURE 40 LB.
 Specific Gravity .600 Pressure Connections at Flange. Pressure Base 4 oz.
 Base and Flowing Temperature 60 deg. Fahr. Atmospheric Pressure 14.4 lb.
 All capacities expressed in thousands of cubic feet.

Differential in Inches of Water	Diameter of Orifice in Inches														
	1	1¼	1½	1¾	2	2¼	2½	2¾	3	3½	4	4½	5	5½	6
1	1.96	3.06	4.4	6.0	7.8	9.9	12.2	14.8	17.6	24.0	31.8	41.	53.	68.	87.
1.5	2.41	3.75	5.4	7.3	9.6	12.1	15.0	18.2	21.7	29.4	38.9	51.	66.	84.	106.
2	2.78	4.33	6.2	8.5	11.1	14.0	17.3	21.0	25.0	33.9	45.0	59.	76.	97.	122.
3	3.40	5.3	7.6	10.4	13.6	17.1	21.2	25.8	30.7	41.6	55.	72.	93.	118.	150.
4	3.93	6.1	8.8	12.0	15.7	19.8	24.5	29.8	35.4	48.0	64.	83.	107.	137.	173.
6	4.81	7.5	10.8	14.7	19.2	24.2	30.0	36.4	43.4	59.	78.	102.	131.	168.	212.
8	5.6	8.7	12.4	17.0	22.2	28.0	34.6	42.1	50.	68.	90.	118.	151.	193.	244.
10	6.2	9.7	13.9	19.0	24.8	31.3	38.7	47.1	56.	76.	101.	132.	169.	216.	273.
15	7.6	11.9	17.0	23.2	30.4	38.3	47.4	58.	69.	93.	123.	161.	207.	265.	335.
20	8.8	13.7	19.7	26.8	35.1	44.3	55.	67.	79.	107.	142.	186.	239.	306.	386.
30	10.8	16.8	24.1	32.9	42.9	54.	67.	82.	97.	131.	174.	228.	293.	375.	473.
40	12.4	19.4	27.8	37.9	49.6	63.	77.	94.	112.	152.	201.	263.	338.	433.	550.
50	13.9	21.6	31.1	42.4	55.	70.	87.	105.	125.	170.	225.	294.	378.	484.	610.
60	15.2	23.7	34.1	46.5	61.	77.	95.	115.	137.	186.	246.	322.	414.	530.	670.
80	17.6	27.4	39.4	54.	70.	89.	109.	133.	158.	215.	284.	372.	479.	610.	770.
100	19.6	30.6	44.0	60.	78.	99.	122.	148.	176.	240.	318.	414.	530.	680.	870.

Table 138
8 INCH LINE HOURLY CAPACITIES OF ORIFICES PRESSURE 60 LB.
 Specific Gravity .600 Pressure Connections at Flange. Pressure Base 4 oz.
 Base and Flowing Temperature 60 deg. Fahr. Atmospheric Pressure 14.4 lb.
 All capacities expressed in thousands of cubic feet.

Differential in Inches of Water	Diameter of Orifice in Inches														
	1	1 1/4	1 1/2	1 3/4	2	2 1/4	2 1/2	2 3/4	3	3 1/2	4	4 1/2	5	5 1/2	6
1	2.29	3.6	5.2	7.0	9.2	11.6	14.3	17.3	20.6	28.1	37.	48.	62.	80.	101.
1.5	2.82	4.4	6.3	8.5	11.2	14.2	17.5	21.3	25.2	34.6	46.	59.	76.	97.	124.
2	3.25	5.1	7.3	9.8	13.0	16.4	20.2	24.6	29.1	39.9	53.	68.	88.	113.	143.
3	3.98	6.2	8.9	12.1	15.9	20.1	24.7	30.1	35.7	48.9	64.	84.	108.	138.	175.
4	4.60	7.1	10.3	14.0	18.4	23.2	28.6	34.8	41.2	56.	74.	97.	125.	160.	202.
6	5.6	8.7	12.6	17.1	22.5	28.4	35.0	42.6	50.	69.	91.	119.	153.	195.	247.
8	6.5	10.1	14.6	19.7	26.0	32.8	40.4	49.2	58.	80.	105.	137.	176.	226.	286.
10	7.3	11.3	16.3	22.1	29.0	36.7	45.2	55.	65.	89.	118.	153.	197.	252.	319.
15	8.9	13.8	19.9	27.1	35.6	44.9	55.	67.	80.	109.	144.	187.	242.	309.	391.
20	10.3	16.0	23.0	31.3	41.1	52.	64.	78.	92.	126.	166.	216.	279.	357.	452.
30	12.6	19.6	28.2	38.3	50.	64.	78.	95.	113.	155.	204.	265.	342.	438.	550.
40	14.5	22.6	32.6	44.2	58.	73.	90.	110.	130.	179.	235.	306.	395.	505.	640.
50	16.3	25.2	36.4	49.4	65.	82.	101.	123.	146.	200.	263.	342.	441.	565.	710.
60	17.8	27.7	39.9	54.	71.	90.	111.	135.	160.	219.	288.	375.	483.	619.	780.
80	20.6	31.9	46.1	62.	82.	104.	128.	156.	184.	253.	333.	433.	560.	715.	900.
100	22.9	35.8	52.	70.	92.	116.	143.	173.	206.	281.	372.	485.	620.	800.	1010.

Table 139
8 INCH LINE HOURLY CAPACITIES OF ORIFICES PRESSURE 100 LB.
 Specific Gravity .600 Pressure Connections at Flange. Pressure Base 4 oz.
 Base and Flowing Temperature 60 deg. Fahr. Atmospheric Pressure 14.4 lb.

All capacities expressed in thousands of cubic feet.

Differential in Inches of Water	Diameter of Orifice in Inches														
	1	1 1/4	1 1/2	1 3/4	2	2 1/4	2 1/2	2 3/4	3	3 1/2	4	4 1/2	5	5 1/2	6
1	2.84	4.4	6.4	8.7	11.3	14.4	17.8	21.5	25.6	34.9	46.	60.	78.	99.	126.
1.5	3.49	5.4	7.9	10.7	14.0	17.6	21.9	26.4	31.2	42.6	57.	73.	95.	121.	154.
2	4.03	6.3	9.1	12.3	16.1	20.4	25.2	30.5	36.1	49.2	66.	85.	110.	140.	178.
3	4.94	7.7	11.1	15.1	19.7	24.9	30.9	37.4	44.2	60.	80.	104.	135.	171.	218.
4	5.7	8.9	12.8	17.4	22.8	28.8	35.7	43.2	50.	70.	93.	120.	155.	198.	252.
6	7.0	10.9	15.7	21.4	27.9	35.3	43.7	53.	62.	85.	114.	147.	190.	242.	309.
8	8.1	12.6	18.2	24.7	32.2	40.7	50.	61.	72.	98.	131.	170.	220.	280.	356.
10	9.0	14.0	20.3	27.6	36.1	45.5	56.	68.	81.	110.	147.	190.	246.	313.	398.
15	11.0	17.2	24.9	33.8	44.2	56.	69.	84.	99.	135.	180.	232.	301.	383.	488.
20	12.7	19.9	28.7	39.0	51.	64.	80.	97.	114.	156.	208.	268.	347.	443.	560.
30	15.6	24.3	35.2	47.8	62.	79.	98.	118.	140.	191.	254.	329.	426.	540.	690.
40	18.0	28.1	40.6	55.	72.	91.	113.	137.	161.	220.	293.	379.	491.	630.	800.
50	20.2	31.4	45.4	62.	81.	102.	126.	153.	180.	246.	328.	424.	550.	700.	890.
60	22.1	34.4	49.7	68.	88.	112.	138.	167.	198.	270.	359.	460.	600.	770.	980.
80	25.5	39.7	57.	78.	102.	129.	160.	193.	228.	311.	415.	540.	690.	890.	1130.
100	28.4	44.4	64.	87.	113.	144.	178.	215.	256.	349.	460.	600.	780.	990.	1260.

Table 140
8 INCH LINE HOURLY CAPACITIES OF ORIFICES PRESSURE 150 LB.
 Specific Gravity .600 Pressure Connections at Flange. Pressure Base 4 oz.
 Base and Flowing Temperature 60 deg. Fahr. Atmospheric Pressure 14.4 lb.
 All capacities expressed in thousands of cubic feet.

Differential in Inches of Water	Diameter of Orifice in Inches														
	1	1 1/4	1 1/2	1 3/4	2	2 1/4	2 1/2	2 3/4	3	3 1/2	4	4 1/2	5	5 1/2	6
1	3.41	5.3	7.7	10.4	13.6	17.3	21.3	25.8	30.7	42.	55.	72.	93.	119.	151.
1.5	4.19	6.6	9.4	12.7	16.8	21.1	26.2	31.5	37.5	51.	68.	88.	114.	146.	186.
2	4.84	7.6	10.9	14.7	19.3	24.4	30.3	36.4	43.3	59.	78.	102.	131.	168.	214.
3	5.9	9.3	13.3	18.0	23.7	29.9	37.1	44.6	53.	73.	96.	125.	161.	206.	262.
4	6.8	10.7	15.4	20.8	27.4	34.5	42.8	51.	61.	84.	111.	144.	185.	238.	303.
6	8.4	13.1	18.9	25.5	33.5	42.3	52.	63.	75.	103.	136.	177.	227.	291.	371.
8	9.7	15.1	21.8	29.4	38.7	48.8	61.	73.	87.	119.	157.	204.	262.	337.	429.
10	10.8	16.9	24.3	32.9	43.3	55.	68.	81.	97.	133.	176.	228.	293.	376.	479.
15	13.2	20.7	29.8	40.3	53.	67.	83.	100.	119.	163.	215.	279.	359.	461.	590.
20	15.3	23.9	34.4	46.5	61.	77.	96.	115.	137.	188.	248.	322.	415.	530.	680.
30	18.7	29.3	42.2	57.	75.	94.	117.	141.	168.	230.	304.	395.	510.	650.	830.
40	21.6	33.8	48.7	66.	87.	109.	135.	163.	194.	266.	351.	456.	590.	750.	960.
50	24.2	37.8	54.	74.	97.	122.	151.	182.	216.	297.	392.	510.	660.	840.	1070.
60	26.5	41.4	60.	81.	106.	134.	166.	199.	237.	325.	430.	560.	720.	920.	1170.
80	30.6	47.9	69.	93.	122.	154.	191.	230.	274.	376.	496.	640.	830.	1060.	1360.
100	34.1	53.	77.	104.	136.	173.	213.	258.	307.	418.	550.	720.	930.	1190.	1510.

ORIFICE CAPACITIES FOR GAS

Table 141
8 INCH LINE HOURLY CAPACITIES OF ORIFICES PRESSURE 200 LB.
 Specific Gravity .600 Pressure Connections at Flange. Pressure Base 4 oz.
 Base and Flowing Temperature 60 deg. Fahr. Atmospheric Pressure 14.4 lb.

All capacities expressed in thousands of cubic feet.

Differential in Inches of Water	Diameter of Orifice in Inches														
	1	1 1/4	1 1/2	1 3/4	2	2 1/4	2 1/2	2 3/4	3	3 1/2	4	4 1/2	5	5 1/2	6
1	3.9	6.1	8.8	11.9	15.6	19.7	24.3	29.4	35.	48.	63.	82.	106.	136.	172.
1.5	4.8	7.4	10.7	14.6	19.1	24.1	29.9	36.1	43.	58.	78.	101.	130.	166.	211.
2	5.5	8.6	12.3	16.8	22.1	27.8	34.5	41.7	50.	67.	90.	117.	150.	192.	244.
3	6.8	10.5	15.1	20.6	27.0	34.0	42.3	51.	61.	82.	110.	143.	184.	235.	299.
4	7.8	12.1	17.4	23.8	31.2	39.3	48.8	59.	70.	95.	127.	165.	212.	271.	345.
6	9.6	14.8	21.4	29.1	38.2	48.1	60.	72.	86.	117.	156.	202.	260.	332.	423.
8	11.0	17.1	24.7	33.7	44.1	56.	69.	83.	99.	135.	180.	233.	300.	384.	488.
10	12.3	19.2	27.6	37.6	49.3	62.	77.	93.	111.	151.	201.	261.	335.	429.	550.
15	15.1	23.5	33.8	46.1	60.	76.	95.	114.	136.	184.	246.	319.	411.	530.	670.
20	17.4	27.1	39.0	53.	70.	88.	109.	132.	157.	213.	284.	369.	474.	610.	770.
30	21.4	33.2	47.8	65.	85.	108.	134.	162.	192.	261.	348.	451.	580.	740.	940.
40	24.7	38.3	55.	75.	99.	124.	154.	187.	222.	301.	402.	520.	670.	860.	1090.
50	27.6	42.9	62.	84.	110.	139.	173.	209.	248.	337.	450.	580.	750.	960.	1220.
60	30.2	46.9	68.	92.	121.	152.	189.	229.	272.	369.	493.	640.	820.	1050.	1340.
80	34.9	54.	78.	106.	140.	176.	218.	264.	314.	426.	570.	740.	950.	1210.	1540.
100	39.0	61.	88.	119.	156.	197.	243.	294.	350.	480.	630.	820.	1060.	1360.	1720.

Table 142
8 INCH LINE HOURLY CAPACITIES OF ORIFICES PRESSURE 300 LB.
 Specific Gravity .600 Pressure Connections at Flange. Pressure Base 4 oz.
 Base and Flowing Temperature 60 deg. Fahr. Atmospheric Pressure 14.4 lb.
 All capacities expressed in thousands of cubic feet.

Differential in Inches of Water	Diameter of Orifice in Inches														
	1	1 1/4	1 1/2	1 3/4	2	2 1/4	2 1/2	2 3/4	3	3 1/2	4	4 1/2	5	5 1/2	6
1	4.7	7.4	10.6	14.4	18.9	23.9	29.5	36.	42.	58.	77.	100.	128.	164.	209.
1.5	5.8	9.0	13.0	17.6	23.1	29.1	36.1	44.	52.	70.	93.	122.	157.	200.	255.
2	6.7	10.4	15.0	20.4	26.7	33.7	41.7	51.	60.	81.	108.	141.	182.	231.	294.
3	8.2	12.7	18.4	24.9	32.7	41.2	51.	62.	73.	100.	132.	173.	222.	283.	360.
4	9.4	14.7	21.2	28.8	37.8	47.6	59.	71.	85.	115.	153.	200.	257.	327.	416.
6	11.6	18.0	26.0	35.3	46.3	58.	72.	87.	104.	141.	187.	245.	314.	400.	510.
8	13.4	20.8	30.0	40.7	53.	67.	83.	101.	120.	163.	216.	283.	363.	462.	590.
10	14.9	23.2	33.5	45.5	60.	75.	93.	113.	134.	182.	241.	316.	406.	520.	660.
15	18.3	28.5	41.1	56.	73.	92.	114.	138.	164.	223.	296.	387.	497.	630.	810.
20	21.1	32.9	47.4	64.	85.	106.	132.	160.	190.	257.	341.	447.	570.	730.	930.
30	25.9	40.3	58.	79.	104.	130.	162.	196.	232.	315.	418.	550.	700.	900.	1140.
40	29.9	46.5	67.	91.	120.	151.	187.	226.	268.	364.	483.	630.	810.	1030.	1320.
50	33.4	52.	75.	102.	134.	168.	209.	252.	300.	407.	540.	710.	910.	1160.	1470.
60	36.6	57.	82.	112.	146.	184.	229.	277.	328.	445.	590.	770.	990.	1270.	1610.
80	42.2	66.	95.	129.	169.	213.	264.	319.	379.	510.	680.	890.	1150.	1460.	1860.
100	47.	74.	106.	144.	189.	239.	295.	360.	424.	580.	770.	1000.	1280.	1640.	2090.

ORIFICE CAPACITIES FOR GAS

Table 143
8 INCH LINE HOURLY CAPACITIES OF ORIFICES PRESSURE 400 LB.
 Specific Gravity .600 Pressure Connections at Flange. Pressure Base 4 oz.
 Base and Flowing Temperature 60 deg. Fahr. Atmospheric Pressure 14.4 lb.
 All capacities expressed in thousands of cubic feet.

Differential in Inches of Water	Diameter of Orifice in Inches														
	1	1 1/4	1 1/2	1 3/4	2	2 1/4	2 1/2	2 3/4	3	3 1/2	4	4 1/2	5	5 1/2	6
1	5.4	8.4	12.1	16.5	21.6	27.4	33.8	41.	49.	66.	88.	114.	148.	189.	239.
1.5	6.6	10.4	14.8	20.2	26.4	33.7	41.5	50.	60.	82.	108.	140.	181.	231.	294.
2	7.6	12.0	17.1	23.3	30.5	38.9	47.9	58.	69.	94.	124.	161.	209.	267.	339.
3	9.4	14.7	21.0	28.6	37.4	47.6	59.	71.	85.	115.	152.	197.	256.	327.	416.
4	10.8	17.0	24.2	33.0	43.2	55.	68.	82.	98.	133.	176.	228.	295.	378.	480.
6	13.2	20.8	29.7	40.4	53.	67.	83.	100.	120.	163.	216.	279.	361.	463.	590.
8	15.3	24.0	34.3	46.7	61.	78.	96.	115.	138.	188.	249.	322.	417.	530.	680.
10	17.1	26.8	38.3	52.	68.	87.	107.	129.	154.	211.	278.	361.	467.	600.	760.
15	20.9	32.8	46.9	64.	84.	107.	131.	158.	189.	259.	341.	442.	570.	730.	930.
20	24.1	37.9	54.	74.	97.	123.	152.	182.	218.	298.	394.	510.	660.	850.	1070.
30	29.6	46.4	66.	90.	118.	151.	186.	223.	267.	365.	482.	620.	810.	1040.	1310.
40	34.2	54.	77.	104.	137.	174.	214.	258.	309.	421.	560.	720.	930.	1200.	1520.
50	38.2	60.	86.	117.	153.	194.	240.	288.	345.	471.	620.	810.	1040.	1340.	1700.
60	41.8	66.	94.	128.	167.	213.	263.	316.	378.	520.	680.	880.	1140.	1460.	1860.
80	48.3	76.	108.	148.	193.	246.	303.	365.	436.	600.	790.	1020.	1320.	1690.	2150.
100	54.	84.	121.	165.	216.	274.	338.	410.	490.	660.	880.	1140.	1480.	1890.	2390.

ORIFICE CAPACITIES FOR GAS

Table 144
10 INCH LINE HOURLY CAPACITIES OF ORIFICES PRESSURE 0 LB.
 Specific Gravity .600 Pressure Connections at Flange. Pressure Base 4 oz.
 Base and Flowing Temperature 60 deg. Fahr. Atmospheric Pressure 14.4 lb.
 All capacities expressed in thousands of cubic feet.

Differential in Inches of Water	Diameter of Orifice in Inches																
	1¼	1½	1¾	2	2¼	2½	2¾	3	3½	4	4½	5	5½	6	6½	7	7½
.10	.50	.71	.98	1.28	1.63	1.97	2.41	2.87	3.9	5.1	6.5	8.1	10.0	12.2	14.9	18.0	21.8
.15	.61	.88	1.20	1.56	1.99	2.44	2.96	3.52	4.8	6.3	7.9	9.9	12.2	15.0	18.3	22.1	26.9
.20	.70	1.01	1.38	1.81	2.30	2.82	3.41	4.07	5.5	7.2	9.1	11.4	14.1	17.3	21.1	25.5	30.9
.30	.86	1.24	1.69	2.21	2.82	3.45	4.18	4.98	6.8	8.9	11.2	14.0	17.3	21.2	25.9	31.2	37.8
.40	1.00	1.43	1.95	2.56	3.26	3.98	4.83	5.7	7.8	10.2	12.9	16.1	19.9	24.5	29.9	36.1	43.6
.50	1.11	1.60	2.18	2.86	3.64	4.46	5.4	6.4	8.7	11.5	14.4	18.0	22.3	27.4	33.4	40.3	48.8
.60	1.22	1.75	2.39	3.12	3.99	4.88	5.9	7.0	9.6	12.5	15.8	19.8	24.4	30.0	36.6	44.2	53.
.80	1.41	2.02	2.76	3.61	4.61	5.6	6.8	8.1	11.1	14.5	18.2	22.8	28.2	34.6	42.2	51.	62.
1	1.58	2.26	3.09	4.04	5.1	6.3	7.6	9.1	12.3	16.1	20.4	25.5	31.5	38.7	47.1	57.	69.
1.5	1.93	2.77	3.78	4.95	6.3	7.7	9.3	11.1	15.1	19.8	25.0	31.2	38.6	47.4	58.	70.	85.
2	2.23	3.20	4.37	5.7	7.3	8.9	10.8	12.9	17.5	22.9	28.8	36.1	44.6	55.	67.	81.	98.
3	2.73	3.91	5.4	7.0	8.9	10.9	13.2	15.7	21.4	28.1	35.3	44.2	55.	67.	82.	99.	120.
4	3.15	4.52	6.2	8.1	10.3	12.6	15.3	18.2	24.7	32.4	40.8	50.	63.	77.	94.	114.	138.
6	3.86	5.5	7.6	9.9	12.6	15.4	18.7	22.3	30.3	39.7	50.	62.	77.	95.	116.	140.	169.
8	4.46	6.4	8.7	11.4	14.6	17.8	21.6	25.7	35.0	45.8	58.	72.	89.	109.	134.	161.	195.
10	4.98	7.1	9.8	12.8	16.3	19.7	24.1	28.7	39.1	51.	65.	81.	100.	122.	149.	180.	218.
15	6.1	8.8	12.0	15.6	19.9	24.4	29.6	35.2	47.9	63.	79.	99.	122.	150.	183.	221.	267.
20	7.0	10.1	13.8	18.1	23.0	28.2	34.1	40.7	55.	72.	91.	114.	141.	173.	211.	255.	309.
30	8.6	12.4	16.9	22.1	28.2	34.5	41.8	49.8	68.	89.	112.	140.	173.	212.	259.	312.	378.
40	10.0	14.3	19.5	25.6	32.6	39.8	48.3	57.	78.	102.	129.	161.	199.	245.	299.	361.	436.
50	11.1	16.0	21.8	28.6	36.4	44.6	54.	64.	87.	115.	144.	180.	223.	274.	334.	403.	488.

Table 145
10 INCH LINE HOURLY CAPACITIES OF ORIFICES PRESSURE 10 LB.

Specific Gravity .600 Pressure Connections at Flange. Pressure Base 4 oz.
 Base and Flowing Temperature 60 deg. Fahr. Atmospheric Pressure 14.4 lb.
 All capacities expressed in thousands of cubic feet.

Differential in Inches of Water	Diameter of Orifice in Inches																
	1¼	1½	1¾	2	2¼	2½	2¾	3	3½	4	4½	5	5½	6	6½	7	7½
.10	.65	.98	1.28	1.66	2.11	2.61	3.1	3.7	5.1	6.6	8.5	10.5	13.0	16.0	19.4	23.5	28.4
.15	.80	1.14	1.56	2.03	2.59	3.19	3.8	4.6	6.2	8.1	10.4	12.9	16.0	19.6	23.7	28.7	34.8
.20	.92	1.32	1.81	2.35	2.98	3.69	4.4	5.3	7.2	9.4	12.0	14.9	18.4	22.6	27.4	33.2	40.2
.30	1.13	1.62	2.21	2.88	3.65	4.51	5.4	6.5	8.8	11.5	14.7	18.2	22.6	27.7	33.5	40.6	49.2
.40	1.30	1.87	2.56	3.32	4.21	5.2	6.3	7.5	10.2	13.3	16.9	21.1	26.1	31.9	38.7	46.9	57.
.50	1.46	2.09	2.86	3.71	4.71	5.8	7.0	8.3	11.3	14.8	18.9	23.5	29.1	35.7	43.3	52.	64.
.60	1.60	2.29	3.12	4.07	5.2	6.4	7.7	9.1	12.4	16.3	20.7	25.9	31.9	39.1	47.4	57.	70.
.80	1.84	2.64	3.61	4.70	6.0	7.4	8.9	10.6	14.4	18.8	23.9	29.8	36.9	45.2	50.	66.	80.
1	2.05	2.95	4.0	5.2	6.7	8.2	9.9	11.8	16.1	21.0	26.6	33.2	41.1	50.	61.	74.	90.
1.5	2.52	3.61	5.0	6.4	8.2	10.1	12.1	14.5	19.7	25.7	32.8	40.8	50.	62.	75.	91.	110.
2	2.91	4.17	5.7	7.4	9.4	11.7	14.0	16.7	22.7	29.7	37.8	47.1	58.	71.	87.	105.	127.
3	3.57	5.1	7.0	9.1	11.5	14.3	17.1	20.4	27.8	36.4	46.3	58.	71.	87.	106.	129.	155.
4	4.12	5.9	8.1	10.5	13.3	16.5	19.8	23.6	32.1	42.0	53.	67.	82.	101.	122.	148.	180.
6	5.0	7.2	9.9	12.9	16.3	20.2	24.2	28.9	39.3	51.	66.	82.	101.	124.	150.	182.	220.
8	5.8	8.3	11.4	14.8	18.8	23.3	28.0	33.4	45.4	59.	76.	94.	117.	143.	173.	210.	254.
10	6.5	9.3	12.8	16.6	21.1	26.1	31.3	37.3	51.	68.	85.	105.	130.	160.	194.	235.	284.
15	8.0	11.4	15.6	20.3	25.9	31.9	38.3	45.7	62.	81.	104.	129.	160.	196.	237.	287.	348.
20	9.2	13.2	18.1	23.5	29.8	36.9	44.3	53.	72.	94.	120.	149.	184.	226.	274.	332.	402.
30	11.3	16.2	22.1	28.8	36.5	45.1	54.	65.	88.	115.	147.	182.	226.	277.	335.	406.	492.
40	13.0	18.7	25.6	33.2	42.1	52.	63.	75.	102.	133.	169.	211.	261.	319.	387.	469.	570.
50	14.6	20.9	28.6	37.1	47.1	58.	70.	83.	113.	148.	189.	235.	291.	357.	433.	520.	640.

Table 146
10 INCH LINE HOURLY CAPACITIES OF ORIFICES
 Specific Gravity .600 Pressure Connections at Flange. Pressure Base 4 oz.
 Base and Flowing Temperature 60 deg. Fahr. Atmospheric Pressure 14.4 lb.
 All capacities expressed in thousands of cubic feet.

Differential in Inches of Water	Diameter of Orifice in Inches																
	1¼	1½	1¾	2	2¼	2½	2¾	3	3½	4	4½	5	5½	6	6½	7	7½
.40	2.44	3.51	4.8	6.2	7.9	9.7	11.7	14.0	19.1	24.9	31.6	39.5	48.8	60.	73.	88.	107.
.50	2.99	4.30	5.8	7.6	9.7	11.9	14.5	17.2	23.3	30.6	38.6	48.5	60.	73.	89.	109.	131.
.60	3.45	4.96	6.7	8.8	11.2	13.7	16.7	19.9	26.9	35.3	44.6	56.	69.	85.	103.	126.	151.
.80	4.23	6.1	8.2	10.8	13.7	16.8	20.4	24.3	33.0	43.3	55.	69.	85.	104.	126.	154.	185.
1	4.88	7.0	9.5	12.5	15.8	19.4	23.6	28.1	38.1	50.	63.	79.	98.	120.	146.	178.	214.
1.5	6.0	8.6	11.7	15.3	19.4	23.8	28.7	34.4	46.7	61.	77.	97.	120.	147.	178.	218.	262.
2	6.9	9.9	13.5	17.6	22.4	27.5	33.4	39.7	54.	70.	89.	112.	138.	170.	206.	251.	302.
3	7.7	11.1	15.1	19.7	25.0	30.7	37.3	44.4	60.	79.	100.	125.	154.	190.	230.	281.	338.
4	9.5	13.6	18.4	24.2	30.6	37.6	45.7	54.	74.	96.	122.	153.	189.	232.	282.	344.	404.
6	10.9	15.7	21.3	27.9	35.4	43.5	53.	63.	85.	111.	141.	177.	218.	268.	326.	397.	479.
8	13.4	19.2	26.1	34.2	43.3	53.	65.	77.	104.	136.	173.	217.	267.	329.	399.	486.	590.
10	15.4	22.2	30.1	39.5	50.	61.	75.	89.	120.	158.	199.	250.	309.	379.	460.	560.	680.
15	17.3	24.8	33.7	44.1	56.	69.	83.	99.	135.	176.	223.	280.	345.	424.	510.	630.	760.
20	18.9	27.2	36.9	48.3	61.	75.	91.	109.	148.	193.	244.	307.	378.	465.	560.	690.	830.
30	21.8	31.4	42.6	56.	71.	87.	106.	126.	170.	223.	282.	354.	436.	540.	650.	790.	960.
40	24.4	35.1	48.0	62.	79.	97.	117.	140.	191.	249.	316.	395.	488.	600.	730.	880.	1070.

ORIFICE CAPACITIES FOR GAS

Table 147
10 INCH LINE HOURLY CAPACITIES OF ORIFICES PRESSURE 40 LB.
 Specific Gravity .600 Pressure Connections at Flange. Pressure Base 4 oz.
 Base and Flowing Temperature 60 deg. Fahr. Atmospheric Pressure 14.4 lb.
 All capacities expressed in thousands of cubic feet.

Differential in Inches of Water	Diameter of Orifice in Inches																
	1¼	1½	1¾	2	2¼	2½	2¾	3	3½	4	4½	5	5½	6	6½	7	7½
1	3.06	4.4	6.0	7.8	9.9	12.2	14.8	17.6	24.0	31.4	40.	50.	61.	75.	92.	111.	134.
1.5	3.75	5.4	7.3	9.6	12.1	15.0	18.2	21.7	29.4	38.6	48.	61.	75.	92.	112.	136.	165.
2	4.33	6.2	8.5	11.1	14.0	17.3	21.0	25.0	33.9	44.6	56.	70.	87.	106.	130.	157.	190.
3	5.3	7.6	10.4	13.6	17.1	21.2	25.8	30.7	41.6	55.	69.	86.	106.	130.	159.	192.	233.
4	6.1	8.8	12.0	15.7	19.8	24.5	29.8	35.4	48.0	63.	79.	99.	122.	150.	184.	222.	269.
6	7.5	10.8	14.7	19.2	24.2	30.0	36.4	43.4	59.	77.	97.	121.	150.	183.	225.	272.	329.
8	8.7	12.4	17.0	22.2	28.0	34.6	42.1	50.	68.	89.	112.	140.	173.	212.	260.	314.	380.
10	9.7	13.9	19.0	24.8	31.3	38.7	47.1	56.	76.	100.	125.	157.	194.	237.	290.	351.	425.
15	11.9	17.0	23.2	30.4	38.3	47.4	58.	69.	93.	122.	153.	192.	237.	290.	356.	430.	520.
20	13.7	19.7	26.8	35.1	44.3	55.	67.	79.	107.	141.	177.	222.	274.	335.	411.	496.	600.
30	16.8	24.1	32.9	42.9	54.	67.	82.	97.	131.	173.	217.	272.	335.	410.	500.	610.	740.
40	19.4	27.8	37.9	49.6	63.	77.	94.	112.	152.	199.	250.	314.	387.	474.	580.	700.	850.
50	21.6	31.1	42.4	55.	70.	87.	105.	125.	170.	223.	280.	351.	433.	530.	650.	780.	950.
60	23.7	34.1	46.5	61.	77.	95.	115.	137.	186.	244.	307.	384.	474.	580.	710.	860.	1040.
80	27.4	39.4	54.	70.	89.	109.	133.	158.	215.	282.	354.	444.	550.	670.	820.	990.	1200.
100	30.6	44.	60.	78.	99.	122.	148.	176.	240.	314.	397.	500.	610.	750.	920.	1110.	1340.

Table 148
10 INCH LINE HOURLY CAPACITIES OF ORIFICES PRESSURE 60 LB.
 Specific Gravity .600 Pressure Connections at Flange. Pressure Base 4 oz.
 Base and Flowing Temperature 60 deg. Fahr. Atmospheric Pressure 14.4 lb.
 All capacities expressed in thousands of cubic feet.

Differential in Inches of Water	Diameter of Orifice in Inches																
	1¼	1½	1¾	2	2¼	2½	2¾	3	3½	4	4½	5	5½	6	6½	7	7½
1	3.6	5.2	7.0	9.2	11.6	14.3	17.3	20.6	28.1	37.	46.	58.	72.	88.	107.	130.	157.
1.5	4.4	6.3	8.5	11.2	14.2	17.5	21.3	25.2	34.3	45.	57.	71.	88.	108.	131.	159.	198.
2	5.1	7.3	9.8	13.0	16.4	20.2	24.6	29.1	39.6	52.	66.	82.	102.	124.	151.	183.	223.
3	6.2	8.9	12.1	15.9	20.1	24.7	30.1	35.7	48.5	63.	80.	100.	125.	152.	185.	225.	273.
4	7.1	10.3	14.0	18.4	23.2	28.6	34.8	41.2	56.	73.	93.	116.	144.	176.	214.	259.	315.
6	8.7	12.6	17.1	22.5	28.4	35.0	42.6	50.	69.	90.	114.	142.	177.	216.	262.	317.	386.
8	10.1	14.6	19.7	26.0	32.8	40.4	49.2	58.	79.	104.	131.	164.	204.	249.	302.	367.	446.
10	11.3	16.3	22.1	29.0	36.7	45.2	55.	65.	89.	116.	147.	183.	228.	278.	338.	410.	498.
15	13.8	19.9	27.1	35.6	44.9	55.	67.	80.	108.	142.	180.	225.	279.	341.	414.	500.	610.
20	16.0	23.0	31.3	41.1	52.	64.	78.	92.	125.	164.	208.	259.	322.	394.	479.	580.	700.
30	19.6	28.2	38.3	50.	64.	78.	95.	113.	153.	200.	254.	318.	395.	482.	590.	710.	860.
40	22.6	32.6	44.2	58.	73.	90.	110.	130.	177.	231.	293.	367.	456.	560.	680.	820.	1000.
50	25.2	36.4	49.4	65.	82.	101.	123.	146.	198.	259.	328.	410.	510.	620.	760.	920.	1110.
60	27.7	39.9	54.	71.	90.	111.	135.	160.	217.	284.	359.	449.	560.	680.	830.	1000.	1220.
80	31.9	46.1	62.	82.	104.	128.	156.	184.	250.	327.	415.	520.	640.	790.	960.	1160.	1410.
100	35.8	52.	70.	92.	116.	143.	173.	206.	281.	367.	465.	580.	720.	880.	1070.	1300.	1570.

Table 149
10 INCH LINE HOURLY CAPACITIES OF ORIFICES PRESSURE 100 LB.
 Specific Gravity .600 Pressure Connections at Flange. Pressure Base 4 oz.
 Base and Flowing Temperature 60 deg. Fahr. Atmospheric Pressure 14.4 lb.
 All capacities expressed in thousands of cubic feet.

Differential in Inches of Water	Diameter of Orifice in Inches																
	1¼	1½	1¾	2	2¼	2½	2¾	3	3½	4	4½	5	5½	6	6½	7	7½
1	4.4	6.4	8.7	11.3	14.4	17.8	21.5	25.6	34.9	46.	58.	72.	89.	109.	133.	161.	195.
1.5	5.4	7.9	10.7	14.0	17.6	21.9	26.4	31.2	42.6	56.	70.	88.	109.	133.	163.	198.	239.
2	6.3	9.1	12.3	16.1	20.4	25.2	30.5	36.1	49.2	64.	81.	102.	126.	154.	188.	229.	276.
3	7.7	11.1	15.1	19.7	24.9	30.9	37.4	44.2	60.	79.	100.	125.	154.	189.	231.	281.	338.
4	8.9	12.8	17.4	22.8	28.8	35.7	43.2	50.	70.	91.	115.	144.	178.	218.	266.	324.	390.
6	10.9	15.7	21.4	27.9	35.3	43.7	53.	62.	85.	112.	141.	177.	218.	267.	326.	397.	478.
8	12.6	18.2	24.7	32.2	40.7	50.	61.	72.	98.	129.	163.	204.	251.	308.	377.	458.	550.
10	14.0	20.3	27.6	36.1	45.5	56.	68.	81.	110.	144.	182.	228.	281.	345.	421.	510.	620.
15	17.2	24.9	33.8	44.2	56.	69.	84.	99.	135.	177.	223.	279.	344.	422.	520.	630.	760.
20	19.9	28.7	39.0	51.	64.	80.	97.	114.	156.	204.	257.	322.	397.	487.	600.	720.	870.
30	24.3	35.2	47.8	62.	79.	98.	118.	140.	191.	250.	315.	395.	486.	600.	730.	890.	1070.
40	28.1	40.6	55.	72.	91.	113.	137.	161.	220.	288.	364.	456.	560.	690.	840.	1020.	1230.
50	31.4	45.4	62.	81.	102.	126.	153.	180.	246.	322.	407.	510.	630.	770.	940.	1150.	1380.
60	34.4	49.7	68.	88.	112.	138.	167.	198.	270.	353.	445.	560.	690.	840.	1030.	1250.	1510.
80	39.7	57.	78.	102.	129.	160.	193.	228.	311.	408.	510.	640.	790.	970.	1190.	1450.	1740.
100	44.4	64.	87.	113.	144.	178.	215.	256.	349.	460.	580.	720.	890.	1090.	1330.	1610.	1950.

ORIFICE CAPACITIES FOR GAS

Table 150
10 INCH LINE HOURLY CAPACITIES OF ORIFICES PRESSURE 150 LB.
 Specific Gravity .600 Pressure Connections at Flange. Pressure Base 4. oz.
 Base and Flowing Temperature 60 deg. fahr. Atmospheric Pressure 14.4 lb.
 All capacities expressed in thousands of cubic feet.

Differential in Inches of Water	Diameter of Orifice in Inches																
	1¼	1½	1¾	2	2¼	2½	2¾	3	3½	4	4½	5	5½	6	6½	7	7½
1	5.3	7.7	10.4	13.6	17.3	21.3	25.8	30.7	42.	54.	68.	86.	106.	130.	159.	193.	234.
1.5	6.6	9.4	12.7	16.8	21.1	26.2	31.5	37.5	51.	67.	84.	106.	131.	160.	195.	237.	287.
2	7.6	10.9	14.7	19.3	24.4	30.3	36.4	43.3	59.	77.	97.	122.	151.	185.	225.	274.	331.
3	9.3	13.3	18.0	23.7	29.9	37.1	44.6	53.	72.	94.	118.	150.	185.	227.	275.	335.	405.
4	10.7	15.4	20.8	27.4	34.5	42.8	51.	61.	83.	109.	137.	173.	214.	262.	318.	387.	468.
6	13.1	18.9	25.5	33.5	42.3	52.	63.	75.	102.	133.	168.	212.	262.	320.	389.	474.	570.
8	15.1	21.8	29.4	38.7	48.8	61.	73.	87.	118.	154.	193.	244.	302.	370.	450.	550.	660.
10	16.9	24.3	32.9	43.3	55.	68.	81.	97.	132.	172.	216.	273.	338.	414.	500.	610.	740.
15	20.7	29.8	40.3	53.	67.	83.	100.	119.	161.	211.	265.	335.	414.	510.	620.	750.	910.
20	23.9	34.4	46.5	61.	77.	96.	115.	137.	186.	244.	306.	386.	479.	580.	710.	870.	1050.
30	29.3	42.2	57.	75.	94.	117.	141.	168.	228.	299.	375.	473.	590.	720.	870.	1060.	1280.
40	33.8	48.7	66.	87.	109.	135.	163.	194.	263.	345.	433.	550.	680.	830.	1010.	1220.	1480.
50	37.8	54.	74.	97.	122.	151.	182.	216.	294.	385.	484.	610.	760.	920.	1120.	1370.	1650.
60	41.4	60.	81.	106.	134.	166.	199.	237.	322.	422.	530.	670.	830.	1010.	1230.	1500.	1810.
80	47.9	69.	93.	122.	154.	191.	230.	274.	372.	487.	610.	770.	960.	1170.	1420.	1730.	2090.
100	53.	77.	104.	136.	173.	213.	258.	307.	420.	540.	680.	860.	1060.	1300.	1590.	1930.	2340.

Table 151
10 INCH LINE HOURLY CAPACITIES OF ORIFICES PRESSURE 200 LB.
 Specific Gravity .600 Pressure Connections at Flange. Pressure Base 4 oz.
 Base and Flowing Temperature 60 deg. Fahr. Atmospheric Pressure 14.4 lb.
 All capacities expressed in thousands of cubic feet.

Differential in Inches of Water	Diameter of Orifice in Inches																
	1¼	1½	1¾	2	2¼	2½	2¾	3	3½	4	4½	5	5½	6	6½	7	7½
1	6.1	8.8	11.9	15.6	19.7	24.3	29.4	35.	48.	62.	79.	99.	122.	149.	182.	220.	267.
1.5	7.4	10.7	14.6	19.1	24.1	29.9	36.1	43.	58.	76.	97.	121.	150.	182.	222.	269.	328.
2	8.6	12.3	16.8	22.1	27.8	34.5	41.7	50.	67.	88.	112.	140.	173.	210.	257.	311.	378.
3	10.5	15.1	20.6	27.0	34.0	42.3	51.	61.	82.	108.	137.	171.	212.	258.	314.	381.	463.
4	12.1	17.4	23.8	31.2	39.3	48.8	59.	70.	95.	125.	158.	198.	245.	298.	363.	440.	530.
6	14.8	21.4	29.1	38.2	48.1	60.	72.	86.	117.	153.	194.	242.	300.	364.	445.	540.	660.
8	17.1	24.7	33.7	44.1	56.	69.	83.	99.	135.	176.	224.	280.	346.	421.	510.	620.	760.
10	19.2	27.6	37.6	49.3	62.	77.	93.	111.	151.	197.	250.	313.	387.	471.	570.	700.	850.
15	23.5	33.8	46.1	60.	76.	95.	114.	136.	184.	242.	306.	383.	474.	580.	700.	850.	1040.
20	27.1	39.0	53.	70.	88.	109.	132.	175.	213.	279.	354.	443.	550.	670.	810.	980.	1200.
30	33.2	47.8	65.	85.	108.	134.	162.	192.	261.	342.	433.	540.	670.	820.	990.	1200.	1470.
40	38.3	55.	75.	99.	124.	154.	187.	222.	301.	395.	500.	630.	770.	940.	1150.	1390.	1690.
50	42.9	62.	84.	110.	139.	173.	209.	248.	337.	441.	560.	700.	870.	1050.	1280.	1560.	1890.
60	46.9	68.	92.	121.	152.	189.	229.	272.	369.	483.	610.	770.	950.	1150.	1410.	1700.	2070.
80	54.	78.	106.	140.	176.	218.	264.	314.	426.	560.	710.	890.	1090.	1330.	1620.	1970.	2390.
100	61.	88.	119.	156.	197.	243.	294.	350.	480.	620.	790.	990.	1220.	1490.	1820.	2200.	2670.

Table 152
10 INCH LINE HOURLY CAPACITIES OF ORIFICES PRESSURE 300 LB.
 Specific Gravity .600 Pressure Connections at Flange. Pressure Base 4 oz.
 Base and Flowing Temperature 60 deg. Fahr. Atmospheric Pressure 14.4 lb.
 All capacities expressed in thousands of cubic feet.

Differential in Inches of Water	Diameter of Orifice in Inches																
	1¼	1½	1¾	2	2¼	2½	2¾	3	3½	4	4½	5	5½	6	6½	7	7½
1	7.4	10.6	14.4	18.9	23.9	29.5	36.	42.	58.	75.	96.	119.	147.	181.	220.	267.	323.
1.5	9.0	13.0	17.6	23.1	29.1	36.1	44.	52.	71.	93.	117.	146.	181.	222.	269.	328.	397.
2	10.4	15.0	20.4	26.7	33.7	41.7	51.	60.	82.	107.	135.	168.	209.	257.	311.	378.	458.
3	12.7	18.4	24.9	32.7	41.2	51.	62.	73.	100.	131.	165.	206.	256.	314.	381.	463.	560.
4	14.7	21.2	28.8	37.8	47.6	59.	71.	85.	116.	151.	191.	238.	295.	363.	440.	530.	650.
6	18.0	26.0	35.3	46.3	58.	72.	87.	104.	142.	185.	234.	291.	361.	445.	540.	660.	790.
8	20.8	30.0	40.7	53.	67.	83.	101.	120.	164.	214.	270.	337.	417.	510.	620.	760.	920.
10	23.2	33.5	45.5	60.	75.	93.	113.	134.	183.	239.	302.	376.	467.	570.	700.	850.	1020.
15	28.5	41.1	56.	73.	92.	114.	138.	164.	225.	293.	369.	461.	570.	700.	850.	1040.	1250.
20	32.9	47.4	64.	85.	106.	132.	160.	190.	259.	338.	427.	530.	660.	810.	980.	1200.	1450.
30	40.3	58.	79.	104.	130.	162.	196.	232.	318.	414.	520.	650.	810.	990.	1200.	1470.	1770.
40	46.5	67.	91.	120.	151.	187.	226.	268.	367.	478.	600.	750.	930.	1150.	1390.	1690.	2050.
50	52.	75.	102.	134.	168.	209.	252.	300.	410.	530.	670.	840.	1040.	1280.	1560.	1890.	2290.
60	57.	82.	112.	146.	184.	229.	277.	328.	449.	590.	740.	920.	1140.	1410.	1700.	2070.	2510.
80	66.	95.	129.	169.	213.	264.	319.	379.	520.	680.	850.	1060.	1320.	1620.	1970.	2390.	2900.
100	74.	106.	144.	189.	239.	295.	360.	424.	580.	750.	960.	1190.	1470.	1810.	2200.	2670.	3230.

ORIFICE CAPACITIES FOR GAS

Table 153
10 INCH LINE HOURLY CAPACITIES OF ORIFICES PRESSURE 400 LB.
 Specific Gravity .600 Pressure Connections at Flange. Pressure Base 4 oz.
 Base and Flowing Temperature 60 deg. Fahr. Atmospheric Pressure 14.4 lb.
 All capacities expressed in thousands of cubic feet.

Differential in Inches of Water	Diameter of Orifice in Inches																
	1¼	1½	1¾	2	2¼	2½	2¾	3	3½	4	4½	5	5½	6	6½	7	7½
1	8.4	12.1	16.5	21.6	27.4	33.8	41.	49.	66.	87.	109.	137.	169.	207.	253.	307.	371.
1.5	10.4	14.8	20.2	26.4	33.7	41.5	50.	60.	82.	106.	135.	168.	208.	255.	309.	375.	456.
2	12.0	17.1	23.3	30.5	38.9	47.9	58.	69.	94.	122.	156.	193.	240.	294.	357.	433.	530.
3	14.7	21.0	28.6	37.4	47.6	59.	71.	85.	115.	150.	191.	237.	294.	360.	437.	530.	640.
4	17.0	24.2	33.0	43.2	55.	68.	82.	98.	133.	173.	220.	274.	339.	416.	500.	610.	740.
6	20.8	29.7	40.4	53.	67.	83.	100.	120.	163.	212.	269.	335.	415.	510.	620.	750.	910.
8	24.0	34.3	46.7	61.	78.	96.	115.	138.	188.	244.	311.	387.	479.	580.	710.	870.	1050.
10	26.8	38.3	52.	68.	87.	107.	129.	154.	211.	273.	348.	433.	540.	660.	800.	970.	1180.
15	32.8	46.9	64.	84.	107.	131.	158.	189.	259.	335.	426.	530.	660.	810.	980.	1190.	1440.
20	37.9	54.	74.	97.	123.	152.	182.	218.	298.	386.	492.	610.	760.	930.	1130.	1370.	1660.
30	46.4	66.	90.	118.	151.	186.	223.	267.	365.	473.	600.	750.	930.	1140.	1380.	1680.	2040.
40	54.	77.	104.	137.	174.	214.	258.	309.	421.	550.	700.	870.	1070.	1320.	1600.	1940.	2350.
50	60.	86.	117.	153.	194.	240.	288.	345.	471.	610.	780.	970.	1200.	1470.	1790.	2160.	2630.
60	66.	94.	128.	167.	213.	263.	316.	378.	520.	670.	850.	1060.	1310.	1610.	1960.	2370.	2880.
80	76.	108.	148.	193.	246.	303.	365.	436.	600.	770.	980.	1220.	1520.	1860.	2260.	2740.	3330.
100	84.	121.	165.	216.	274.	338.	410.	490.	660.	870.	1090.	1370.	1690.	2070.	2530.	3070.	3710.

ORIFICE CAPACITY DIAGRAMS

The orifice capacity diagrams shown on Pages 426 and 427 will be found useful in determining the proper size of orifice to be used where the orifice in the line is indicating too low or too high a differential, and in cases where the flow is to be increased or decreased. These diagrams can be used to advantage where the pressure remains practically the same, or where it does not vary over a limit of 20 per cent. As an example, we will assume that a 6 inch line contains a 3 inch orifice where the differential pressure averages 3 inches on a 50 inch gauge. In order to obtain more accurate results the differential should average around 20 inches. By drawing a line from coefficient line **C** where the size of orifice is indicated, to 3 inch differential on differential line **D** the intersection will be about 14,200 on line **Q**. Then by drawing a line from 20 inch differential at line **D** through the intersection of the first line and line **Q** until the second line intersects with line **C** it will be noted that the nearest size of orifice for a 6 inch line is 2 inches so that a 6"×2" orifice at 20 inches differential will have approximately the same capacity per hour at a certain pressure as a 3 inch orifice at 3 inches differential. As a further example, assume that a 6" × 1¾" orifice with connections at the Flange produces a differential of 10 inches. By drawing a line from line **C** to line **D** at the intersection on line **Q** is approximately 8000. We will assume that the flow through the line was 20,000 cu. ft. per hour and that the proposed flow is to be 50,000 cu. ft. per hour at approximately the same pressure. Therefore the increase in flow will be 2½ times so that on the diagram we would draw a line from an average differential 20 inches, on line **D**, through 20,000 on line **Q**, (20,000=2½×8,000) to intersection with line **C**, which indicates an orifice 6"×2¾".

The quantities on line **Q** are relative only and do not refer to cu. ft., gallons or any particular units. These diagrams may also be used for water or oil by always re-

membering that the numbers shown along the line **Q** are relative quantities only. In the same manner as in the first example if a 6 inch line contains a 3 inch orifice measuring oil, water or steam at 3 inches and it is desired to increase the average differential to 20 inches, the size of the new orifice would be 6" \times 2". If the proposed flow and differential are both increased as in the second example, the same relative sizes of orifice will be used, or the 6" \times 1 $\frac{3}{4}$ " orifice will be increased to a 6" \times 2 $\frac{3}{8}$ " orifice. Either of the diagrams may be used for determining the proper size of orifice on account of the change of quantity or change of differential. Care should be used that the diagram for the proper pressure connections shall be used.

INFORMATION TO BE FURNISHED WHEN ORDERING ORIFICE METERS AND DIFFERENTIAL GAUGES

Measurement of Gas and Air.

1. Estimate of maximum rate of flow in cu. ft. per hour.
2. Estimate of minimum rate of flow in cu. ft. per hour.
3. Approximate maximum line pressure in lb. per sq. in.
4. Approximate minimum line pressure in lb. per sq. in.
5. Specific Gravity of gas (Air = 1.00).
6. Internal diameter of pipe line, if not standard or if it is 12 inches or larger, give actual inside diameter.
7. Pressure Base at which gas is to be measured.

Measurement of Steam

1. Estimate of maximum rate of flow in pounds or horse power per hour.
2. Estimate of minimum rate of flow in pounds or horse power per hour.
3. Approximate maximum line pressure in pounds per square inch.

ORIFICE CAPACITIES

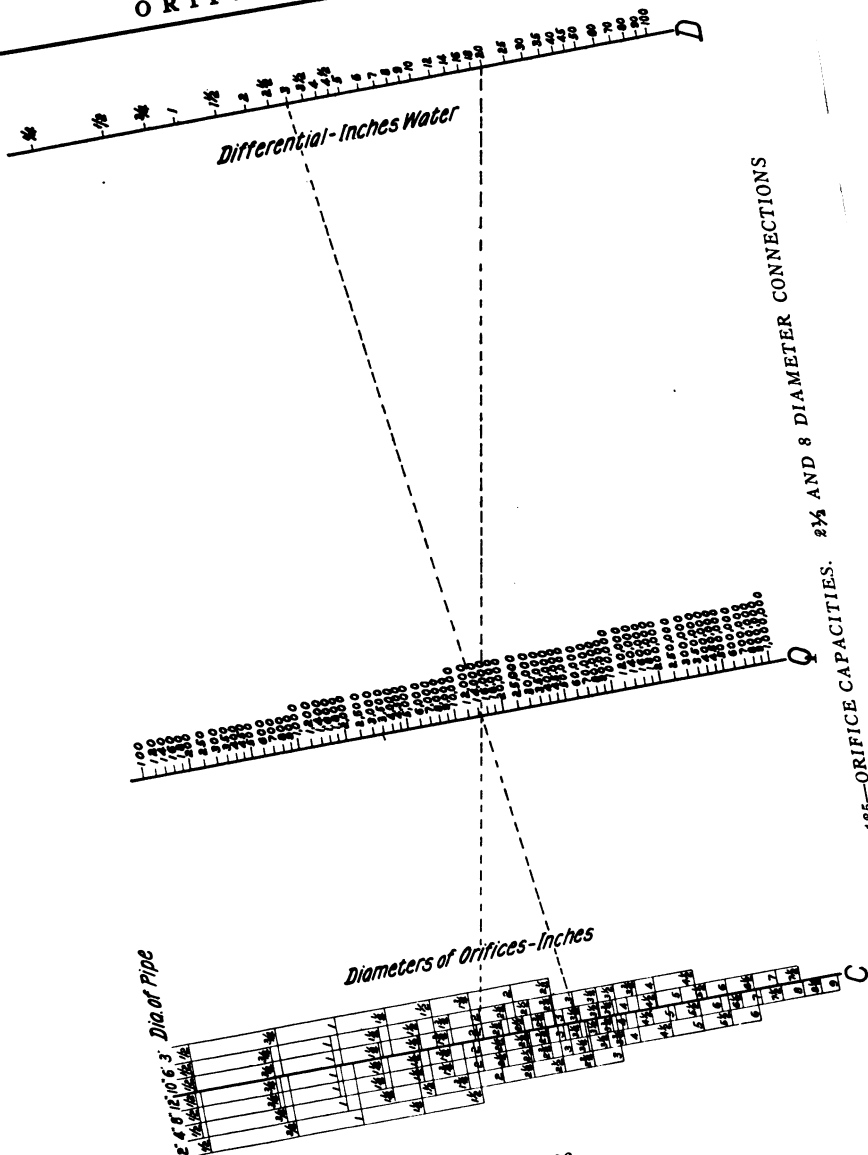

Fig. 135—ORIFICE CAPACITIES. 2 1/2 AND 8 DIAMETER CONNECTIONS

ORIFICE CAPACITIES

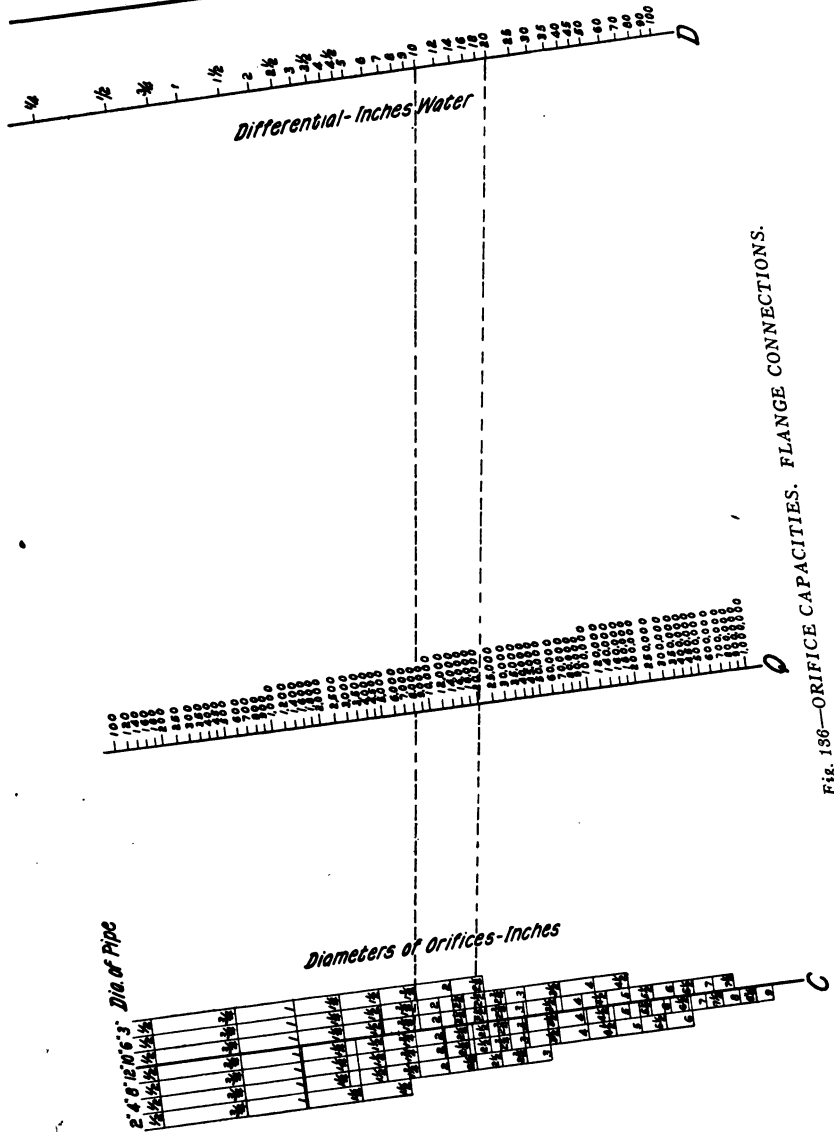

Fig. 186—ORIFICE CAPACITIES. FLANGE CONNECTIONS.

4. Approximate minimum line pressure in pounds per square inch.

5. Internal diameter of pipe line, if not standard, or if 12 inches or larger give actual inside diameter.

Measurement of Water

1. Estimate of maximum rate of flow in gallons per hour.

2. Estimate of minimum rate of flow in gallons per hour.

3. Approximate line pressure.

4. Internal diameter of pipe line, if not standard or if 12 inches or larger give actual inside diameter.

Measurement of Oil

1. Estimate of maximum rate of flow in barrels per hour.

2. Estimate of minimum rate of flow in barrels per hour.

3. Approximate line pressure.

4. Specific Gravity of Oil or degrees Baume.

5. Viscosity.

6. Kind of Oils.

INDEX

	PAGE
A	
Absolute Pressure	34
—Absolute Temperature	57
—Vacuum Table	43
Absolute Temperature	51
—Absolute Pressure	57
Acceleration	45
Accuracy of Orifice Meter	121
Adding Mercury	247
Adjustment, Differential Gauges	258
Air—Derivation of, Form- ula for Flow of	79, 163
—Hourly Orifice Coeffi- cients, Pipe Con- nections— P_b 14.4	173
— P_b 14.7	181
—Pressures at Flanges	213
—Installations	251-254
—Meters, Installing	239
—Orifice Capacities— Flange Connections	216
—Pipe Connections	214
—Testing Differential Gauges	255
—Velocity Formula for Flow of	111
Areas of Orifices	75
Atmospheric Pressure	32
—Changes, Multipliers for	189-196
—Effect of, on Gas Meas- urement	221
—Gas Fields	35
B	
Barometer	33
Barometric Pressure, Abso- lute Pressure Table	43
—Effect on Gas Measure- ment	221
—Vacuum	43

Barometric Pressure Changes, Multipliers for	189-196
Base, Pressure	44
—Multipliers	188-195
Base Temperature	52
—Multipliers	191-197
Bombshell Type of Differ- ential Gauge	14
Boyle's Law	55
By-Pass	248

C

Calculator, Orifice Meter	267
Capacities, Differential Gauge	126
Capacities, Orifice, Air, Pipe Connections	214-249
—Air, Flange Con- nections	216-249
—Gas, Pipe Connections	214, 215, 344-383
—Gas, Flange Con- nections	216, 217, 384-423
—Oil	332
—Steam	291
—Water	314
Charles' Law	53
Charlottenburg Tests	98
Charts—Changing, Orifice Meter	152
—Reading—Air and Gas	261
—Oil	340
—Steam	305
—Water	317
Chart Report	265
Clock	248
Coefficients—Derivation— Air and Gas	79-166
—Oil	322
—Steam	272
—Water	309
—Determination of	77

INDEX

Coefficients—Continued	PAGE
—Gas and Air, Flange Connections.....	213
—Hourly Orifice — Gas and Air, Pipe Connections.....	173-184
—Oil.....	330
—Steam.....	282-287
—Water.....	312
—Multipliers for revision of.....	186
—Velocity—.....	50-171
—Diagrams.....	108-109
—Flange Connections, Table.....	211
—Pipe Connections, Table.....	208
Coke Oven Gas, Orifice Meter for.....	246
Combination Gauge.....	129
Compressibility of Gases..	25
Connections, Gauge Line.....	135, 245
Constitution of Matter, Theory of.....	19
Contracts, Gas.....	230
Critical Temperatures and Pressures of Various Gases, Table.....	21

D

Derivation of Coefficients	
—Gas and Air.....	79, 163
—Oil.....	322
—Steam.....	272
—Water.....	309
Differential Gauges—Capacities.....	126
—History of.....	11
—Indicating.....	130
—Installing, (see Installing and Installation)	
—2½ Inch.....	129
—Mercury Float Type... ..	117
—Ordering, Information required.....	425
—Permanent Gauges for Testing.....	158
—Pocket Gauge for Testing.....	156

Differential Gauges—Continued	PAGE
—Portable Gauges for Testing.....	159
—Recording Differential Pressure and Temperature.....	132
—Sectional View of.....	119
—Temperature Effect on.....	120
—Testing—Gas and Air.....	255
—Oil.....	335
—Steam.....	296
—Water.....	316
Differential Pen Arm.....	247
—Vibrating.....	250
Differential Pressure—Extensions for Oil and Water.....	313
—Vs. Static Pressure....	132

E

Equivalents, Pressure, Table.....	31-32
Erie Holder Tests.....	99
Expansive Power of Gases..	26

F

Filing Orifice Meter Charts, Form of Face of Envelope.....	270
Flange Connections.....	135
Flowing Gases, Velocity Head of.....	64
Flowing Temperature Multipliers for Changes of.....	192-198
Fluids—.....	19-20
—Pressure of.....	22
—Velocity of.....	47
Formula, Derivation of—	
—Air and Gas.....	79, 163
—Oil.....	322
—Steam.....	272
—Water.....	309
Friction Loss.....	136
—Capacity.....	139
—Percentage of.....	136
Full Flow Connections....	134

INDEX

	PAGE
Gas—Comparative Measurements.....	219
—Compressibility.....	25
—Contracts.....	230
—Expansive Power of.....	26
—Orifice Capacities for Flange Connections.....	217, 384-423
—Pipe Connections.....	215, 344-383
—Orifice Meter Formula for.....	80, 163
—Perfect.....	53
—Law of.....	59
Gauges, Differential—Capacities.....	126
—Checking for zero.....	255
—History of.....	11
—Indicating Flow.....	130
—Information required when ordering.....	425
—Installing — Gas and Air.....	247
—Oil.....	335
—Steam.....	296
—Water.....	316
—Mercury Float Type.....	117
—Ordering.....	425
—Permanent Gauges for Testing.....	158
—Temperature Effect on Testing, for measuring Gas and Air.....	255
—Oil.....	335
—Steam.....	296
—Water.....	316
Gauges—.....	
—Indicating.....	130
—Pressure.....	36
—Setting up.....	247
—Siphon.....	157
—Special Types of.....	129
—Spring.....	36
Glass.....	247
Gravitation.....	22
Gravity, Force of.....	22
Gravity, Specific—.....	186
—Multipliers for Changes of.....	193-199
—Oil, Multipliers.....	331

	PAGE
Head—Pressure and Liquid.....	28
—Velocity—.....	46
—of Flowing Gases..	64
History, Orifice Meter and Differential Gauge.....	11
Holder—Erie, Tests.....	99
—Joplin, Tests.....	78
Horse Power, lb. from and at 212 deg. fahr.....	289
Hourly Capacities of Orifice—Gas and Air.....	214-217, 344-423
—Oil.....	332
—Steam.....	291
—Water.....	314
Hourly Orifice Coefficients	
—Gas and Air...171, 184,	213
—Oil.....	330
—Steam.....	282, 287
—Water.....	312
Humidity Factors.....	87

I

Indicating Gauge.....	130
Information required when ordering Meters and Gauges.....	425
Ink and Pens.....	249
Inspector's Test Pump for Static Pressure Gauges	154
Installation—Diagrams for Measuring Steam....	303
—Multiple Orifice Meter.	236
—Oil Meter, Diagrams..	339
—Orifice Meter for Measuring Gases.....	241
—Pitot Meter.....	6
—Water Meter, Diagram	318
Installing Differential and Static Pressure Gauges	247
Installing Meters—Gas and Air.....	239
—Oil.....	335
—Steam.....	296
—Water.....	316
Instructions to Meter Attendants.....	152

J

Joplin Holder Tests.....	78
--------------------------	----

INDEX

L		
	PAGE	
Law—Boyle's.....	55	
—Charles'.....	53	
—Pascal's.....	27	
—Perfect Gases.....	59	
Layout, Orifice Meter.....	69	
Leakage Tests—Erie Holder.....	101	
—Joplin Holder.....	83	
Leaks in Installations.....	249	
Liquid Head and Pressure.....	28	
Liquids, Fluids and Gases.....	20	
Loss—Friction.....	136	
—Pressure.....	141	
M		
Matter—States of.....	19	
—Theory of Constitution of.....	19	
Measurement — Comparative Gas.....	219	
—Effect of Atmospheric Pressure on Gas.....	221	
—Flow of Fluids.....	110	
—Gases, Orifice Meter Installations for.....	241	
—Oil, Tests.....	333	
—Steam, Sizes of Orifices for.....	293	
—Steam, Tests.....	294	
—Water, Tests.....	315	
Mercury, Adding.....	247	
Mercury Float Type Differential Gauges.....	117	
Meter, Orifice.....	1	
—Accuracy of.....	121	
—Adaptability of.....	17	
—Body.....	76	
—Calculator.....	267	
—Chart Report.....	265	
—Coefficients (See Coefficients)		
—Coke Oven Gas.....	246	
—Derivation of, Formula for Flow of—Air and Gas.....	79, 163	
—Oil.....	322	
—Steam.....	273	
—Water.....	309	
Meter, Orifice—		
<i>Continued</i>		PAGE
—Flanges.....		245
—Formula for Gas.....		80
—History of.....		11
—Installing (See Installing and Installation)		
—Multiple Installation.....		236
—Ordering.....		425
—Test Report.....		259
Meter, Pitot—Installation.....	6	
—Operation.....	6	
Multipliers—Atmospheric Pressure Changes.....	189, 196	
—Base Temperature Changes.....	191, 197	
—Changes of Flowing Temperature.....	192, 198	
—Change of Pressure Base.....	188, 195	
—Revision of Coefficients.....	186	
—Specific Gravity of Gas.....	193, 199-200	
—Specific Gravity of Oil.....	331	
O		
Oil—Capacities of Orifice for.....		332
—Coefficients for.....		330
—Measurement Tests.....		333
Oil Meters, Installing and Testing.....		335
Oliphant Pitot Tube.....		3
Orifice Areas.....		75
Orifice Coefficients, Determination of.....		77
—Hourly—Gas and Air.....		171-185, 213
—Oil.....		330
—Steam.....		282, 287
—Water.....		312
Orifices.....		73
—Sizes for Measuring Steam.....		293
—Hourly Capacities, Gas and Air.....		214-217, 344-423
—Oil.....		332
—Steam.....		291
—Water.....		314

I N D E X

	PAGE
Orifice Meter.....	1
—Accuracy of.....	121
—Adaptability of.....	17
—Body.....	76
—Calculator.....	267
—Changing Charts.....	152
—Chart Report.....	265
—Charts, Form for Face of Envelope for Filing.....	270
—Coefficients (See Coefficients)	
—Coke Oven Gas.....	246
—Derivation of, Formula for Flow of Air.....	79
—Flanges.....	245
—Formula for Gas.....	80
—History.....	11
—Installations (See Installation and Installing)	
—Layout.....	69
—Multiple Installation.....	236
—Test.....	259

P

Pascal's Law.....	27
Pen Arm—Vibration of... ..	145
—Vibrating Differential.....	250
Pens and Ink.....	249
Perfect Gases.....	53
—Law of.....	59
Permanent Gauges for Testing Differential Gauges..	158
Pipe Connections.....	135
—Coefficients (See Coefficients)	
—Coefficient of Velocity.....	108-109, 208-212
—Orifice Capacities for Air and Gas.....	214-217, 344-383
Pitot Meter—Installation.....	6
—Operation.....	6
Pitot Tip and Box.....	5
Pitot Tube and Meter.....	2
Pitot Tube, Oliphant.....	3
Pocket Gauge for Testing Differential Gauge....	156
Portable Pitot Tip and Box.....	5
Portable Water Differential Test Gauges.....	159

	PAGE
Power of Gases, Expansive.....	26
Pressure—Absolute.....	34
—Atmospheric.....	32
—Effect of, on Gas Measurement.....	221
—Multipliers for Change.....	189, 196
—Of Gas Fields.....	35
—Base.....	44, 188, 195
—Connections or Taps..	135
—Equivalents, Table....	31
—Gauges.....	36
—Head of Gas.....	62, 63
—Liquid Head.....	28
—Loss.....	141
—Static.....	39
Pressure Base, Multipliers for Change of.....	188
Pressure Connections.....	135
—Static.....	248
Pressure Extensions, Differential for Oil and Water.....	313
Pulsating Flow.....	143
—Determination.....	147
Pulsation.....	146
Pulsation vs. Vibration....	145
Pump, Inspector's Test, for Static Pressure Gauges	154
Pump, Vacuum Gauge Test	155

R

Range, Differential of Gauges.....	126
Reading Charts....	261-305-340
—Calculator.....	267
Recording Differential and Static Pressure and Temperature Gauge... ..	132
Relation Differential to Pressure.....	132
Relationship between Static Pressure and Location of Orifice.....	134
Report Orifice Meter Chart	265
Revision of Coefficients, Multipliers for.....	186

I N D E X

S					
	PAGE				PAGE
Saturated Steam, Proper-				Testing Differential Gauges,	
ties of.....	277			Permanent Gauges for..	158
Setting up Gauge.....	247			—Pocket Gauge for.....	156
Siphon or U Gauges.....	157			—Portable Gauge for....	159
Special Types of Gauges..	129			Testing—Gas and Air	
Specific Gravity.....	186			Meters.....	255
—Multipliers....193, 199,	200			—Oil Meters.....	335
—Multipliers for, Oil....	331			—Static Spring.....	258
Specific Gravity Changes,				—Steam Meters.....	296
Multipliers for.....	193			—Water Meters.....	316
Specifications for Orifice				Theory of Constitution of	
Meter Computations..	202			Matter.....	19
Spring Gauges.....	36			Tube, Pitot and Meter....	2
States of Matter.....	19			—Oliphant.....	3
Static Pressure.....	39			V	
Static Pressure Gauges, In-				Vacuum.....	39
pector's Test Pump for	154			—Absolute Pressure,	
—Installing.....	247			Table.....	43
Static Spring, Testing....	258			Vacuum Gauge Test Pump	155
Steam, Hourly Capacities				Vapor.....	21
of Orifices.....	291			Vapor and Gas, Distinction	
—Hourly Orifice Coeffi-				between.....	21
cients.....282, 287				Velocity.....	44
—Properties of, Table... 277				Velocity Head.....	46
—Tests.....	294			—Flowing Gases.....	64
T					
Taps or Pressure Convec-				Velocity, Fluid.....	47
tions.....	135			Velocity, Coefficient of..50,	171
Temperature.....	51			—Pipe Connections	108, 208
—Absolute.....	51			—Flange Connections... 211	
—Absolute Pressure....	57			Vibration of Differential	
Temperature Base.....	52			Pen Arm.....145, 250	
Temperature Effect on Dif-				Viscosity, Multipliers for,	
ferential Gauges.....	120			Oil.....	331
Testing Apparatus.....	154			W	
Tests.....11, 13				Water, Hourly Orifice Co-	
—Erie Holder.....	99			efficients for.....	312
—Joplin Holder.....	78			Water Measurement Tests.	315
—Leakage, Erie Holder.. 101				Water Meter Installations,	
—Leakage, Joplin Holder 83				Diagram.....	318
—Oil Measurement.....	333			Water Meters, Installing	
—Orifice Meter, Report.. 259				and Testing.....	316
—Steam Measurement.. 294					
—Water Measurement... 315					

Hand Book of Casinghead Gas

THIRD EDITION 1922

*Revised with 300 pages of new material and
80 new Illustrations.*

650 PAGES 160 ILLUSTRATIONS 175 TABLES

Cloth Bound, \$3.75 In Leather, \$4.50

Measurement of Gases Where Density Changes

*A Complete Set of Multiplier Tables with full
explanation of same*

Price in Cloth, 50 Cents

PUBLISHED BY

METRIC METAL WORKS

Eric, Penna.

Hand Book of Natural Gas

THIRD EDITION

CAREFULLY REVISED WITH OVER 400 PAGES OF
NEW MATERIAL AND 140 NEW CUTS
CONTAINING
740 PAGES 250 ILLUSTRATIONS 120 TABLES

Price in Cloth \$3.75

In Leather \$4.50

Pressure Extensions

STATIC PRESSURE—

From 0 to 500 pounds

From 0 to 29 inches of mercury vacuum

DIFFERENTIAL PRESSURE—

From 1 to 100 inches of water

Price in Buckrum, \$10.00 Postpaid

Size 8 × 14

PUBLISHED BY
METRIC METAL WORKS
Eric, Penna.

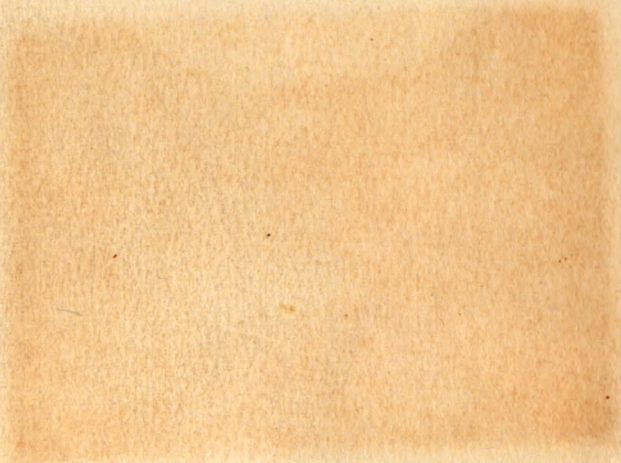

375
net

YB 24338

111	
64	53
60	03
124	05
<hr/>	
59	61

360' 01'

473642 TN880
 W43
 1922
Westcott Mining
Dept.

UNIVERSITY OF CALIFORNIA LIBRARY

